



**THE DATASHEET OF
BQ24261MYFFT**



bq2426x 3-A, 30-V, Host-Controlled Single-Input, Single-Cell Switched-Mode Li-Ion Battery Charger With Power-Path Management and USB-OTG Support

Not Recommended for New Designs : bq24260, bq24261

1 Features

- Charge Time Optimizer (Enhanced CC/CV Transition) for Faster Charging
- Integrated FETs for up to 3-A Charge Rate at 5% Accuracy and 93% Peak Efficiency
- Boost Capability to Supply 5 V at 1 A at IN for USB OTG Supply
- Integrated 17-mΩ Power-Path MOSFET and Optional BGATE Control to Maximize Battery Life and Instantly Start up From a Deeply Discharged Battery or No Battery
- 30-V Input Rating With Overvoltage Protection Supports 5-V USB 2.0/3.0 and 12-V USB Power Delivery (bq24261/1M)
- Small Solution Size In a 2.4-mm x 2.4-mm 36-Pin WCSP or 4-mm x 4-mm 24-Pin QFN Package
 - Total Charging Solution Can be 50 mm² or Less With WCSP
- Safe and Accurate Battery-Management Functions Programmed Using I²C Interface
 - Charge Voltage, Current, Termination Threshold, Input Current Limit, V_{IN_DPM} Threshold
 - Voltage-Based, JEITA-Compatible NTC Monitoring Input
 - Thermal Regulation Protection for Input Current Control
 - Thermal Shutdown and Protection

2 Applications

- Smart Phones and Tablets
- Handheld Products
- Power Banks and External Battery Packs
- Small Power Tools
- Portable Media Players and Gaming

3 Description

The bq24260/bq24261/bq24261M/bq24262 is a highly integrated single-cell Li-Ion battery charger and system power path management device that supports operation from either a USB port or wall adapter supply. The power-path feature allows the bq24260/1/1M/2 to power the system from a high efficiency DC-DC converter while simultaneously and independently charging the battery. The power path also permits the battery to supplement the system current requirements when the adapter cannot. Many features are programmable using the I²C interface. To support USB OTG applications, the bq24260/1/1M/2 is configurable to boost the battery voltage to 5 V and supply up to 1 A at the input. The battery is charged with three phases: precharge, constant current, and constant voltage. Thermal regulation prevents the die temperature from exceeding 125°C. Additionally, a JEITA-compatible battery pack thermistor monitoring input (TS) is included to prevent the battery from charging outside of its safe temperature range.

Device Information⁽¹⁾

PART NUMBER	PACKAGE	BODY SIZE (NOM)
bq24260/1/1M/2	DSBGA (36)	2.40 mm x 2.40 mm
	QFN (24)	4.00 mm x 4.00 mm

(1) For all available packages, see the orderable addendum at the end of the data sheet.

4 Application Schematic

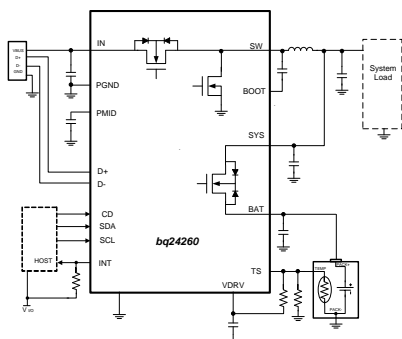

Charge Time Optimizer Effect

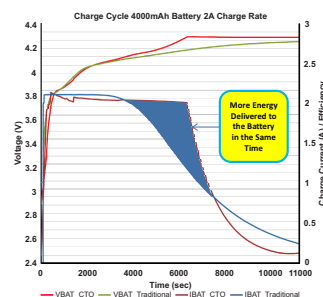

Table of Contents

1 Features	1	9.5 Programming.....	27
2 Applications	1	9.6 Register Maps	30
3 Description	1	10 Application and Implementation	38
4 Application Schematic	1	10.1 Application Information.....	38
5 Revision History	2	10.2 Typical Application	38
6 Device Comparison Table	4	11 Power Supply Recommendations	43
7 Pin Configuration and Functions	4	11.1 Requirements for SYS Output	43
8 Specifications	6	11.2 Requirements for Charging.....	43
8.1 Absolute Maximum Ratings	6	12 Layout	43
8.2 ESD Ratings.....	6	12.1 Layout Guidelines	43
8.3 Recommended Operating Conditions.....	6	12.2 Layout Example	44
8.4 Thermal Information	7	13 Device and Documentation Support	45
8.5 Electrical Characteristics.....	7	13.1 Documentation Support	45
8.6 Switching Characteristics	11	13.2 Related Links	45
8.7 Typical Characteristics	11	13.3 Community Resources.....	45
9 Detailed Description	13	13.4 Trademarks	45
9.1 Overview	13	13.5 Electrostatic Discharge Caution.....	45
9.2 Functional Block Diagram	14	13.6 Glossary	45
9.3 Feature Description.....	16	14 Mechanical, Packaging, and Orderable Information	46
9.4 Device Functional Modes.....	16		

5 Revision History

NOTE: Page numbers for previous revisions may differ from page numbers in the current version.

Changes from Revision D (April 2015) to Revision E	Page
• Changed absolute max voltage for logic I/O pins from 5.0 V to 5.5 V	6
• Added test condition $V_{IN} > V_{UVLO}$ for $V_{BATUVLO}$	9
• Changed image object for Figure 42	41
• Added Community Resources Section.....	45

Changes from Revision C (March 2015) to Revision D	Page
• Added device bq24261M	1
• Changed minimum capacitance for DRV pin from 1 μ F to 2.2 μ F.	5
• Changed absolute max voltage for DRV, SYS from 5.0 V to 5.5 V	6
• Changed VSYSREG(HI) from VBATREG+1.6% to original VBATREG+2.5% typical	7
• Added bq24261M VSYSREG(HI) = 1.6% typical	7
• Changed ILIM(DISCH) from 9 A to original 6 A typical	7
• Added bq24261M ILIM(DISCH) = 9 A typical	7
• Added Explanation for Reg05h B4 Force D+/D-	36
• Changed bypass capacitor value from 1 μ F to 2.2 μ F in the Typical Application Circuit	38

Changes from Revision B (March 2014) to Revision C	Page
• Added <i>ESD Ratings</i> table, <i>Feature Description</i> section, <i>Device Functional Modes</i> , <i>Application and Implementation</i> section, <i>Power Supply Recommendations</i> section, <i>Layout</i> section, <i>Device and Documentation Support</i> section, and <i>Mechanical, Packaging, and Orderable Information</i> section	1

Changes from Revision A (January 2014) to Revision B **Page**

• Changed global format to new data sheet schema	1
• Changed device number from "bq24262A" to "bq24262" throughout	1
• Changed V_{BATREG} accuracy for 0-125C, added 0-85C, and added mV specific numbers to Elec Characteristics table.	8
• Added <i>Switching Characteristics</i>	11
• Added <i>Power Supply Recommendations</i>	43
• Added <i>Device and Documentation Support</i>	45
• Changed location of Ordering Information to <i>Mechanical, Packaging, and Orderable Information</i>	46

Changes from Original (December 2013) to Revision A **Page**

• Added specifications to Electrical Characteristics table pertaining to RGE package	7
• Added separate lines for I_{INLIM} current for YFF and RGE packages.	9
• Changed V_{DO_DRV} spec MAX voltage from "500 mV" to "450 mV"	9
• Changed the wording of the Safety Timer description for clarification.	22
• Changed text in the F/S Mode Protocol section from "...to either transmit data to the slave (R/W bit 1) or receive data from the slave (R/W bit 0" to "...to either transmit data to the slave (R/W bit 0) or receive data from the slave (R/W bit 1" for clarification.	28

bq24260, bq24261, bq24261M, bq24262

SLUSBU4E – DECEMBER 2013 – REVISED DECEMBER 2015

www.ti.com

6 Device Comparison Table

PART NUMBER	OVP	\overline{CE} BIT DEFAULT	D+/D- DETECTION	TIMERS (SAFETY AND WATCHDOG)	BATTERY DISCHARGE CURRENT LIMIT (MIN)	SYSTEM REGULATION VOLTAGE (TYP)	DEFAULT V_{BATREG}
bq24260	10.5	0 (Charge Enabled)	Yes	Yes	4 A	$V_{BATREG} + 2.5\%$	3.6 V
bq24261	14	1 (Charge Disabled)	No	Yes	4 A	$V_{BATREG} + 2.5\%$	3.6 V
BQ24261M	14	1 (Charge Disabled)	No	Yes	6 A	$V_{BATREG} + 1.6\%$	3.6 V
bq24262	6.5	0 (Charge Enabled)	No	No	4 A	$V_{BATREG} + 2.5\%$	4.2 V

7 Pin Configuration and Functions

YFF Package 36-Pin DSBGA

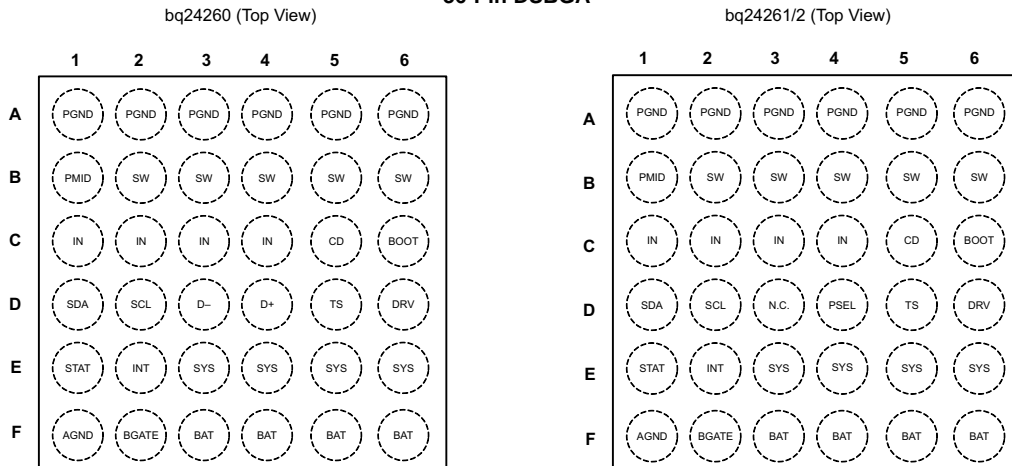

RGE Package 24-Pin VQFN (Top View)

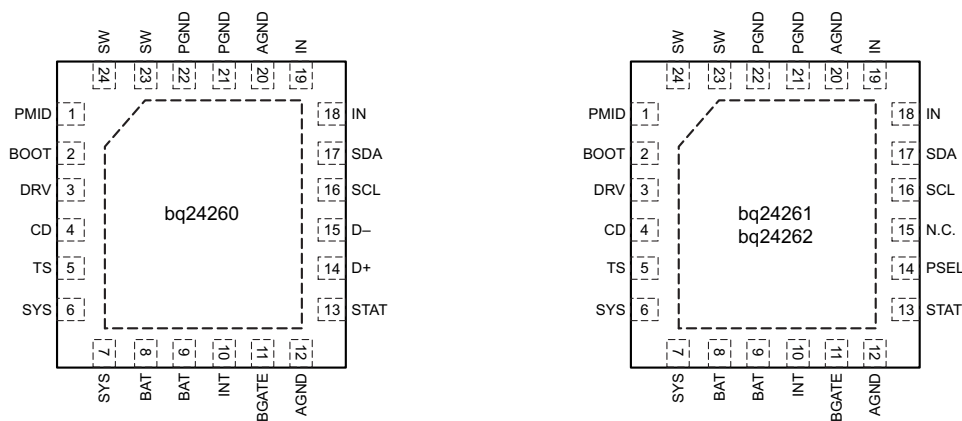

Pin Functions

NAME	PIN				I/O	DESCRIPTION
	bq24260		bq24261/1M/2			
	DSBGA	VQFN	DSBGA	VQFN		
AGND	F1	12, 20	F1	12, 20		Analog Ground. Connect to the thermal pad (for QFN only) and the ground plane of the circuit.
BAT	F3-F6	8, 9	F3-F6	8, 9	I/O	Battery Connection. Connect to the positive terminal of the battery. Bypass BAT to GND with at least 1 μ F of ceramic capacitance. See Application and Implementation for additional details.
BGATE	F2	11	F2	11	O	External Discharge MOSFET Gate Connection. BGATE drives an external P-Channel MOSFET to provide a very low resistance discharge path. Connect BGATE to the gate of the external MOSFET. BGATE is low during high impedance mode or when no input is connected. If no external FET is required, leave BGATE disconnected. Do not connect BGATE to GND.
BOOT	C6	2	C6	2	I	High Side MOSFET Gate Driver Supply. Connect 0.033 μ F of ceramic capacitance (voltage rating > 10 V) from BOOT to SW to supply the gate drive for the high side MOSFET.
CD	C5	4	C5	4	I	IC Hardware Disable Input. Drive CD high to place the bq24260/1/1M/2 in hi-z mode. Drive CD low for normal operation. CD is pulled low internally with 100 k Ω .
D+	D4	14	–	–	I	D+ and D– Connections for USB Input Adapter Detection. When a source is initially connected to the input during DEFAULT mode, and a short is detected between D+ and D–, the input current limit is set to 1.5 A. If a short is not detected, the USB100 mode is selected.
D–	D3	15	–	–	I	
DRV	D6	3	D6	3	O	Gate Drive Supply. DRV is the bias supply for the gate drive of the internal MOSFETs. Bypass DRV to PGND with a 10-V or higher rated, +/-10%, X5R or better 2.2 μ F ceramic capacitor. DRV may be used to drive external loads up to 10mA. DRV is active whenever the input is connected and $V_{IN} > V_{UVLO}$ and $V_{IN} > (V_{BAT} + V_{SLP})$.
IN	C1-C4	18, 19	C1-C4	18, 19	I	DC Input Power Supply. IN is connected to the external DC supply (AC adapter or USB port). Bypass IN to PGND with at least a 4.7 μ F of ceramic capacitance.
INT	E2	10	E2	10	O	Status Output. INT is an open-drain output that signals charging status and fault interrupts. INT pulls low during charging. INT is high impedance when charging is complete, disabled or the charger is in high impedance mode. When a fault occurs, a 128- μ s pulse is sent out as an interrupt for the host. INT is enabled /disabled using the EN_STAT bit in the control register. Connect INT to a logic rail through a 100-k Ω resistor to communicate with the host processor.
PGND	A1-A6	21,22	A1-A6	21,22	–	Ground terminal. Connect to the thermal pad (for QFN only) and the ground plane of the circuit.
PMID	B1	1	B1	1	I	High Side Bypass Connection. Connect at least 1 μ F of ceramic capacitance from PMID to PGND as close to the PMID and PGND terminals as possible.
PSEL	–	–	D4	14	I	Hardware Input Current Limit. In DEFAULT mode, PSEL selects the input current limit. Drive PSEL high to select USB100 (bq24261/1M) or USB500 (bq24262) mode, drive PSEL low to select 1.5 A mode.
SCL	D2	16	D2	16	I	I ² C Interface Clock. Connect SCL to the logic rail through a 10-k Ω resistor. Do not leave floating.
SDA	D1	17	D1	17	I/O	I ² C Interface Data. Connect SDA to the logic rail through a 10-k Ω resistor.
STAT	E1	13	E1	13	O	Status Output. STAT is an open-drain output that signals charging status and fault interrupts. STAT pulls low during charging. STAT is high impedance when charging is complete, disabled or the charger is high impedance mode. When a fault occurs, a 128- μ s pulse is sent out as an interrupt for the host. STAT is enabled /disabled using the EN_STAT bit in the control register. Connect STAT to a logic rail using an LED for visual indication or through a 100-k Ω resistor to communicate with the host processor.
SW	B2-B6	23, 24	B2-B6	23, 24	O	Inductor Connection. Connect to the switched side of the external inductor. The inductance must be between 1.5 μ H and 2.2 μ H.
SYS	E3-E6	6, 7	E3-E6	6, 7	I	System Voltage Sense and Charger FET Connection. Connect SYS to the system output at the output bulk capacitors. Bypass SYS locally with at least 10 μ F of ceramic capacitance. The SYS rail must have at least 20 μ F of total capacitance for stable operation. See Application and Implementation for additional details.
TS	D5	5	D5	5	I	Battery Pack NTC Monitor. Connect TS to the center tap of a resistor divider from DRV to GND. The NTC is connected from TS to GND. The TS function provides 4 thresholds for JEITA compatibility. TS faults are reported by the I ² C interface. Pull TS high to V_{DRV} to disable the TS function if unused. See the <i>NTC Monitor</i> section for more details on operation and selecting the resistor values.
Thermal Pad	–	–	–	–	–	There is an internal electrical connection between the exposed thermal pad and the PGND terminal of the device. The thermal pad must be connected to the same potential as the PGND terminal on the printed circuit board. Do not use the thermal pad as the primary ground input for the device. PGND terminal must be connected to ground at all times.

8 Specifications

8.1 Absolute Maximum Ratings ⁽¹⁾

over operating free-air temperature range (unless otherwise noted)

		MIN	MAX	UNIT
Terminal Voltage (with respect to PGND)	IN	-1.3	30	V
	BOOT, PMID	-0.3	30	
	SW	-0.7	20	
	BAT	-0.3	5	
	DRV, SYS, BGATE, CD, INT, PSEL, SDA, SCL, STAT, TS	-0.3	5.5	
BOOT to SW		-0.3	5	V
Output Current (Continuous)	SW		4.5	A
	SYS, BAT (charging/ discharging)		3.5	
Output Current (<20 ms pulse, <10% duty cycle)	BAT (discharging)		6	A
Input Current (Continuous)			2.75	A
Output Sink Current	STAT, INT		10	mA
Operating free-air temperature		-40	85	°C
Junction temperature, T _J		-40	125	
Storage temperature, T _{stg}		-40	300	

(1) Stresses beyond those listed under *Absolute Maximum Ratings* may cause permanent damage to the device. These are stress ratings only, which do not imply functional operation of the device at these or any other conditions beyond those indicated under *Recommended Operating Conditions*. Exposure to absolute-maximum-rated conditions for extended periods may affect device reliability.

8.2 ESD Ratings

		VALUE	UNIT
V _(ESD) Electrostatic discharge	Human-body model (HBM), per ANSI/ESDA/JEDEC JS-001 ⁽¹⁾	±2000	V
	Charged-device model (CDM), per JEDEC specification JESD22-C101 ⁽²⁾	±500	

(1) JEDEC document JEP155 states that 500-V HBM allows safe manufacturing with a standard ESD control process.

(2) JEDEC document JEP157 states that 250-V CDM allows safe manufacturing with a standard ESD control process.

8.3 Recommended Operating Conditions

over operating free-air temperature range (unless otherwise noted)

		MIN	NOM	MAX	UNIT
V _{IN}	IN voltage range	4.2		28 ⁽¹⁾	V
	IN operating voltage range (bq24260)	4.2		10	
	IN operating voltage range (bq24261/1M)	4.2		13.2	
	IN operating voltage range (bq24262)	4.2		6.0	
I _{IN}	Input current, IN input			2.5	A
I _{SW}	Output Current from SW, DC			3	A
I _{BAT} , I _{SYS}	Charging			3	A
	Discharging, using internal battery FET			3	
T _J	Operating junction temperature range	0		125	°C

(1) The inherent switching noise voltage spikes should not exceed the absolute maximum rating on either the BOOT or SW terminals. A *tight* layout minimizes switching noise.

8.4 Thermal Information

THERMAL METRIC ⁽¹⁾		bq2426x		UNIT
		YFF [DSBGA]	RGE [VQFN]	
		36 PINS	24 PINS	
R _{θJA}	Junction-to-ambient thermal resistance	55.8	32.6	°C/W
R _{θJctop}	Junction-to-case (top) thermal resistance	0.5	30.5	°C/W
R _{θJB}	Junction-to-board thermal resistance	10	3.3	°C/W
ψ _{JT}	Junction-to-top characterization parameter	2.6	0.4	°C/W
ψ _{JB}	Junction-to-board characterization parameter	9.9	9.3	°C/W
R _{θJcbot}	Junction-to-case (bottom) thermal resistance	N/A	2.6	°C/W

(1) For more information about traditional and new thermal metrics, see the *IC Package Thermal Metrics* application report, [SPRA953](#).

8.5 Electrical Characteristics

Circuit of [Figure 7](#), $V_{UVLO} < V_{IN} < V_{OVP}$ AND $V_{IN} > V_{BAT} + V_{SLP}$, $T_J = -40^{\circ}\text{C}$ to 125°C and $T_J = 25^{\circ}\text{C}$ for typical values (unless otherwise noted)

PARAMETER	TEST CONDITIONS	MIN	TYP	MAX	UNIT
INPUT CURRENTS					
I _{IN}	V _{UVLO} < V _{IN} < V _{OVP} and V _{IN} > V _{BAT} + V _{SLP} PWM switching		15		mA
	YFF Package: V _{UVLO} < V _{IN} < V _{OVP} and V _{IN} > V _{BAT} + V _{SLP} PWM NOT switching			6.5	
	RGE Package: V _{UVLO} < V _{IN} < V _{OVP} and V _{IN} > V _{BAT} + V _{SLP} PWM NOT switching			6.65	
	0°C < T _J < 85°C, V _{IN} = 5 V, Hi-Z Mode				250
I _{BAT_HIZ}	0°C < T _J < 85°C, V _{BAT} = 4.2 V, V _{IN} = 5 V, SCL, SDA = 0 V or 1.8 V, Hi-Z Mode			15	μA
	YFF Package: 0°C < T _J < 85°C, V _{BAT} = 4.2 V, V _{IN} = 0 V, SCL, SDA = 0 V or 1.8 V			77	
	RGE Package: 0°C < T _J < 85°C, V _{BAT} = 4.2 V, V _{IN} = 0 V, SCL, SDA = 0 V or 1.8 V			80	
POWER-PATH MANAGEMENT					
V _{SYSREG(LO)}	System Regulation Voltage V _{BAT} < V _{MINSYS}	V _{MINSYS} + 80 mV	V _{MINSYS} + 100 mV	V _{MINSYS} + 120 mV	V
V _{SYSREG(HI)}	System Regulation Voltage bq24260/1/2 - Battery FET turned off, no charging, V _{BAT} > 3.5 V bq24261M - Battery FET turned off, no charging, V _{BAT} > 3.5 V	V _{BATREG} +2.2%	V _{BATREG} +2.5%	V _{BATREG} +2.77%	V
		V _{BATREG} +1.4%	V _{BATREG} +1.6%	V _{BATREG} +1.77%	
V _{MINSYS}	Minimum System Voltage Regulation Threshold V _{BAT} + V _{DO(SYS_BAT)} < 3.5 V	3.44	3.5	3.55	V
t _{DGL(MINSYS_CMP)}	Deglitch time, V _{MINSYS} comparator rising		8		ms
V _{BSUP1}	Enter supplement mode threshold V _{BAT} > V _{BUVLO}		V _{BAT} – 20 mV		V
V _{BSUP2}	Exit supplement mode threshold V _{BAT} > V _{BUVLO}		V _{BAT} – 5 mV		V
I _{LIM(DISCH)}	Current Limit, Discharge or Supplement Mode ⁽¹⁾ bq24260/1/2 - V _{LIM(BGATE)} = V _{BAT} – V _{SYS} bq24261M - V _{LIM(BGATE)} = V _{BAT} – V _{SYS}	4	6		A
		6	9		
t _{DGL(SC1)}	Deglitch Time, SYS Short Circuit during Discharge or Supplement Mode Measured from I _{BAT} = 7A to FET off		250		μs
t _{REC(SC1)}	Recovery time, SYS Short Circuit during Discharge or Supplement Mode		2		s
	Battery Range for BGATE Operation	2.5		4.5	V

(1) Continuous and periodic pulse currents from BAT to SYS are limited by Output Current specifications in Absolute Maximum Ratings table.

bq24260, bq24261, bq24261M, bq24262

SLUSBU4E – DECEMBER 2013 – REVISED DECEMBER 2015

www.ti.com

Electrical Characteristics (continued)

Circuit of Figure 7, $V_{UVLO} < V_{IN} < V_{OVP}$ AND $V_{IN} > V_{BAT} + V_{SLP}$, $T_J = -40^{\circ}\text{C}$ to 125°C and $T_J = 25^{\circ}\text{C}$ for typical values (unless otherwise noted)

PARAMETER		TEST CONDITIONS	MIN	TYP	MAX	UNIT
BATTERY CHARGER						
$R_{ON(BAT-SYS)}$	Internal battery charger MOSFET ON-resistance	Measured from BAT to SYS, $V_{BAT} = 4.2\text{ V}$, Hi-Z mode	YFF	17	25	mΩ
			RGE	32	47	
V_{BATREG}	Charge Voltage	Operating in voltage regulation, Programmable Range	3.5		4.44	V
	RGE Package Voltage Regulation Accuracy	$T_J = 0^{\circ}\text{C}$ to 50°C	-0.5%		0.5%	
	RGE Package Voltage Regulation Accuracy	$T_J = 0^{\circ}\text{C}$ to 85°C	-0.7%		0.7%	
	YFF Package Voltage Regulation Accuracy	$T_J = 0^{\circ}\text{C}$ to 85°C	-0.75%		0.75%	
	RGE and YFF Package Voltage Regulation Accuracy	$T_J = 0^{\circ}\text{C}$ to 125°C	-1.0%		1.0%	
	YFF Package Voltage Regulation Accuracy	$T_J = 25^{\circ}\text{C}$	-29.2		28.1	mV
	YFF Package Voltage Regulation Accuracy	$T_J = 0^{\circ}\text{C}$ to 85°C	-32.0		29.3	
	YFF Package Voltage Regulation Accuracy	$T_J = 0^{\circ}\text{C}$ to 125°C	-40.2		29.3	
I_{CHARGE}	Fast Charge Current Range	$V_{BATSHRT} \leq V_{BAT} < V_{BAT(REG)}$	500		3000	mA
	Fast Charge Current Accuracy	$500\text{ mA} \leq I_{CHARGE} \leq 1\text{ A}$	-10%		10%	
		$I_{CHARGE} > 1000\text{ mA}$	-5%		5%	
$V_{BATSHRT}$	Battery short-circuit threshold		1.9	2	2.1	V
$V_{BATSHRT_HYS}$	Hysteresis for $V_{BATSHRT}$	Battery voltage falling		100		mV
	Deglitch time for battery short to fastcharge transition	V_{BAT} rising or falling		1		ms
$I_{BATSHRT}$	Battery short-circuit charge current	$V_{BAT} < V_{BATSHRT}$	33.5	50	66.5	mA
I_{TERM}	Termination charge current	$I_{TERM} \leq 50\text{ mA}$	-30%		30%	
		$50\text{ mA} < I_{TERM} < 200\text{ mA}$	-15%		15%	
		$I_{TERM} \geq 200\text{ mA}$	-15%		10%	
$t_{DGL(TERM)}$	Deglitch time for charge termination	Both rising and falling, 2-mV over-drive, $t_{RISE}, t_{FALL} = 100\text{ ns}$		32		ms
V_{RCH}	Recharge threshold voltage	Below V_{BATREG}	100	120	150	mV
$t_{DGL(RCH)}$	Deglitch time	V_{BAT} falling below V_{RCH} , $t_{FALL} = 100\text{ ns}$		32		ms
$V_{DET(SRC1)}$	Battery detection voltage threshold (TE = 1)	During current source (Turn $I_{BATSHRT}$ off)		V_{RCH}		V
$V_{DET(SRC2)}$		During current source (Turn $I_{BATSHRT}$ on)		$V_{RCH} - 200\text{mV}$		V
$V_{DET(SNK)}$		During current sink		$V_{BATSHRT}$		V
I_{DETECT}	Battery detection current before charge done (sink current)	Termination enabled (TE = 1)		7		mA
$t_{DETECT(SRC)}$	Battery detection time (sourcing current)	Termination enabled (TE = 1)		2		s
$t_{DETECT(SNK)}$	Battery detection time (sinking current)	Termination enabled (TE = 1)		250		ms

Electrical Characteristics (continued)

Circuit of Figure 7, $V_{UVLO} < V_{IN} < V_{OVP}$ AND $V_{IN} > V_{BAT} + V_{SLP}$, $T_J = -40^{\circ}\text{C}$ to 125°C and $T_J = 25^{\circ}\text{C}$ for typical values (unless otherwise noted)

PARAMETER	TEST CONDITIONS	MIN	TYP	MAX	UNIT			
INPUT CURRENT LIMITING								
I_{INLIM}	Input current limiting threshold	USB charge mode, $V_{IN} = 5\text{ V}$, Current pulled from SW	$I_{INLIM} = \text{USB100}$	90	95	100	mA	
			$I_{INLIM} = \text{USB500}$	450	475	500		
			$I_{INLIM} = \text{USB150}$	125	140	150		
			$I_{INLIM} = \text{USB900}$	800	850	900		
			$I_{INLIM} = 1.5\text{ A}$	1425	1500	1575		
			$I_{INLIM} = 2\text{ A}$, YFF Package	1850	2000	2150		
			$I_{INLIM} = 2\text{ A}$, RGE Package	1850	2000	2200		
			$I_{INLIM} = 2.5\text{ A}$, YFF Package	2300	2500	2700		
	$I_{INLIM} = 2.5\text{ A}$, RGE Package	2225	2500	2825				
V_{IN_DPM}	Input based DPM threshold range	Charge mode, programmable via I ² C			4.2	11.6	V	
	V_{IN_DPM} threshold Accuracy				-3%	3%		
V_{DRV} BIAS REGULATOR								
V_{DRV}	Internal bias regulator voltage	$V_{IN} > 5\text{ V}$			4.3	4.8	5.3	V
I_{DRV}	DRV Output Current				0		10	mA
V_{DO_DRV}	DRV Dropout Voltage ($V_{IN} - V_{DRV}$)	$I_{IN} = 1\text{ A}$, $V_{IN} = 4.2\text{ V}$, $I_{DRV} = 10\text{ mA}$					450	mV
STATUS OUTPUT (STAT, INT)								
V_{OL}	Low-level output saturation voltage	$I_O = 10\text{ mA}$, sink current					0.4	V
I_{IH}	High-level leakage current	$V_{STAT} = V_{INT} = 5\text{ V}$					1	μA
INPUT PINS (CD, PSEL)								
V_{IL}	Input low threshold						0.4	V
V_{IH}	Input high threshold				1.4			V
$R_{PULLDOWN}$	CD pulldown resistance	CD Only				100		kΩ
	Deglintch for CD and PSEL	CD or PSEL rising/falling				100		μs
PROTECTION								
V_{UVLO}	IC active threshold voltage	V_{IN} rising			3.2	3.3	3.4	V
V_{UVLO_HYS}	IC active hysteresis	V_{IN} falling from above V_{UVLO}				300		mV
$V_{BATUVLO}$	Battery Undervoltage Lockout threshold	V_{BAT} falling, $V_{IN} > V_{UVLO}$				2.4	2.6	V
V_{SLP}	Sleep-mode entry threshold, $V_{IN} - V_{BAT}$	$2.0\text{ V} < V_{BAT} < V_{BATREG}$, V_{IN} falling			0	40	120	mV
$t_{DGL(BAT)}$	Deglintch time, BAT above $V_{BATUVLO}$ before SYS starts to rise					1.2		ms
V_{SLP_HYS}	Sleep-mode exit hysteresis	V_{IN} rising above V_{SLP}			40	100	190	mV
$t_{DGL(VSLP)}$	Deglintch time for supply rising above $V_{SLP} + V_{SLP_HYS}$	Rising voltage, 2-mV over drive, $t_{RISE} = 100\text{ ns}$				30		ms
V_{OVP}	Input supply OVP threshold voltage	IN rising, 100-mV hysteresis	bq24260	10.1	10.5	10.9	V	
			bq24261/1M	13.6	14	14.4		
			bq24262	6.25	6.5	6.75		
V_{BATGD}	Good Battery Monitor Threshold (BQ24260/1 only)	V_{IN} Rising			3.51	3.7	3.89	V
$t_{DGL(BUCK_OVP)}$	Deglintch time, VIN OVP in Buck Mode	IN falling below V_{OVP}				30		ms
V_{BOVP}	Battery OVP threshold voltage	V_{BAT} threshold over V_{OREG} to turn off charger during charge			$1.03 \times V_{BATREG}$	$1.05 \times V_{BATREG}$	$1.07 \times V_{BATREG}$	V

bq24260, bq24261, bq24261M, bq24262

SLUSBU4E – DECEMBER 2013 – REVISED DECEMBER 2015

www.ti.com

Electrical Characteristics (continued)

Circuit of Figure 7, $V_{UVLO} < V_{IN} < V_{OVP}$ AND $V_{IN} > V_{BAT} + V_{SLP}$, $T_J = -40^{\circ}\text{C}$ to 125°C and $T_J = 25^{\circ}\text{C}$ for typical values (unless otherwise noted)

PARAMETER		TEST CONDITIONS	MIN	TYP	MAX	UNIT
V_{BOVP_HYS}	V_{BOVP} hysteresis	Lower limit for V_{BAT} falling from above V_{BOVP}		1		% of V_{BATREG}
$t_{DGL(BOVP)}$	BOVP Deglitch	Battery entering/exiting BOVP		8		ms
$I_{CbCLIMIT}$	Cycle-by-cycle current limit	V_{SYS} shorted	4.1	4.5	4.9	A
T_{SHTDWN}	Thermal trip			150		$^{\circ}\text{C}$
	Thermal hysteresis			10		$^{\circ}\text{C}$
T_{REG}	Thermal regulation threshold	Input current begins to cut off		125		$^{\circ}\text{C}$
	Safety Timer Accuracy		-20%		20%	
PWM						
R_{DSON_Q1}	Internal top MOSFET ON-resistance	YFF Package: Measured from IN to SW		75	120	m Ω
		RGE Package: Measured from IN to SW		80	135	m Ω
R_{DSON_Q2}	Internal bottom N-channel MOSFET ON-resistance	YFF Package: Measured from SW to PGND		75	115	m Ω
		RGE Package: Measured from SW to PGND		80	135	m Ω
f_{OSC}	Oscillator frequency		1.35	1.5	1.65	MHz
D_{MAX}	Maximum duty cycle			95%		—
D_{MIN}	Minimum duty cycle		0%			—
BATTERY-PACK NTC MONITOR (1)						
V_{HOT}	High temperature threshold	V_{TS} falling, 2% V_{DRV} Hysteresis	27.3	30	32.6	% V_{DRV}
V_{WARM}	Warm temperature threshold	V_{TS} falling, 2% V_{DRV} Hysteresis	36.0	38.3	41.2	% V_{DRV}
V_{COOL}	Cool temperature threshold	V_{TS} rising, 2% V_{DRV} Hysteresis	54.7	56.4	58.1	% V_{DRV}
V_{COLD}	Low temperature threshold	V_{TS} rising, 2% V_{DRV} Hysteresis	58.2	60	61.8	% V_{DRV}
T_{SOFF}	TS Disable threshold	V_{TS} rising, 4% V_{DRV} Hysteresis	80		85	% V_{DRV}
$t_{DGL(TS)}$	Deglitch time on TS change	Applies to V_{HOT} , V_{WARM} , V_{COOL} and V_{COLD}		50		ms
I²C-COMPATIBLE INTERFACE						
V_{IH}	Input low threshold level	$V_{PULL-UP} = 1.8\text{ V}$, SDA and SCL	1.3			V
V_{IL}	Input low threshold level	$V_{PULL-UP} = 1.8\text{ V}$, SDA and SCL			0.4	V
V_{OL}	Output low threshold level	$I_L = 5\text{ mA}$, sink current			0.4	V
I_{BIAS}	High-Level leakage current	$V_{PULL-UP} = 1.8\text{ V}$, SDA and SCL			1	μA
$t_{WATCHDOG}$			30	50		s
$t_{I2CRESET}$				700		ms
OTG BOOST SUPPLY						
I_{QBAT_BOOST}	Quiescent current during boost mode (BAT pin)	$3.3\text{ V} < V_{BAT} < 4.5\text{ V}$, no switching			100	μA
	Battery voltage range for specified boost operation	V_{BAT} falling	3.3		4.5	V
V_{IN_BOOST}	Boost output voltage (to pin V_{BUS})	$3.3\text{ V} < V_{BAT} < 4.5\text{ V}$ over line and load	4.95	5.05	5.2	V
I_{BO}	Maximum output current for boost	$3.3\text{ V} < V_{BAT} < 4.5\text{ V}$	BOOST_ILIM = 1	1000		mA
			BOOST_ILIM = 0	500		
I_{BLIMIT}	Cycle by cycle current limit for boost (measured at low-side FET)	$3.3\text{ V} < V_{BAT} < 4.5\text{ V}$	BOOST_ILIM = 1	4		A
			BOOST_ILIM = 0	2		
$V_{BOOSTOVP}$	Overshoot protection threshold for boost (IN pin)	Signals fault and exits boost mode	5.8	6	6.2	V
$t_{DGL(BOOST_OVP)}$	Deglitch Time, V_{IN} OVP in Boost Mode			170		μs
$V_{BURST(ENT)}$	Upper V_{IN} voltage threshold to enter burst mode (stop switching)		5.1	5.2	5.3	V
$V_{BURST(EXIT)}$	Lower V_{BUS} voltage threshold to exit burst mode (start switching)		4.9	5	5.1	V

8.6 Switching Characteristics

over operating free-air temperature range (unless otherwise noted)

PARAMETER		TEST CONDITIONS	MIN	TYP	MAX	UNIT
f _{OSC}	Oscillator frequency		1.35	1.5	1.65	MHz
D _{MAX}	Maximum duty cycle			95%		
D _{MIN}	Minimum duty cycle		0%			

8.7 Typical Characteristics

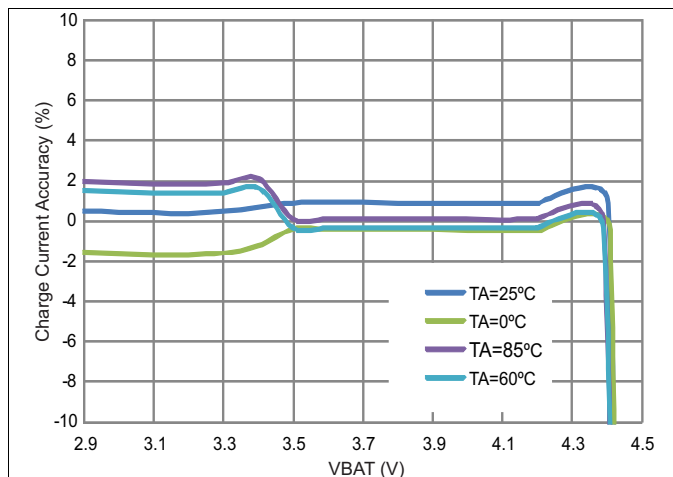

Figure 1. Charge Current vs Battery Voltage

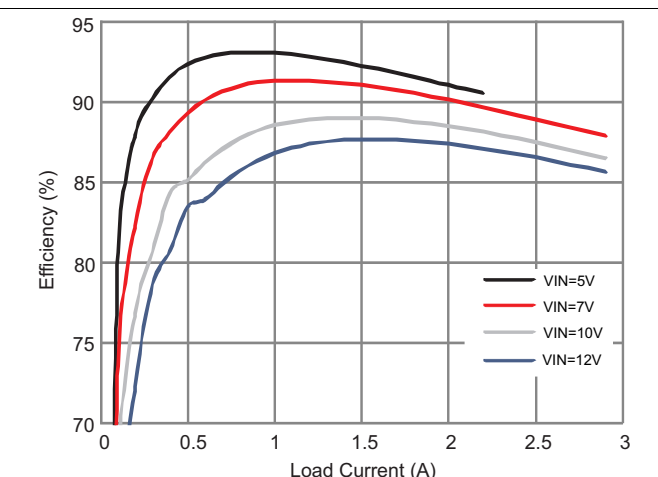

Figure 2. Efficiency vs Output Current

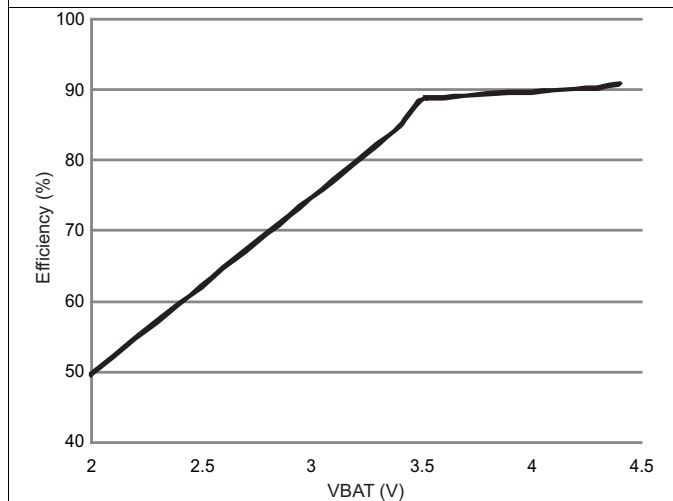

Figure 3. Efficiency vs Battery Voltage

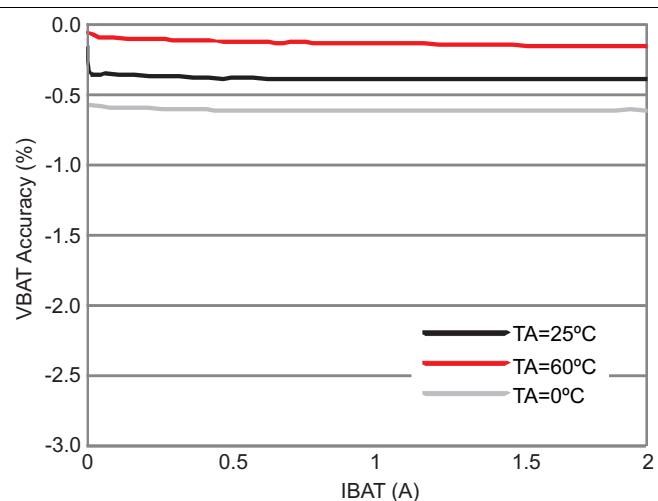
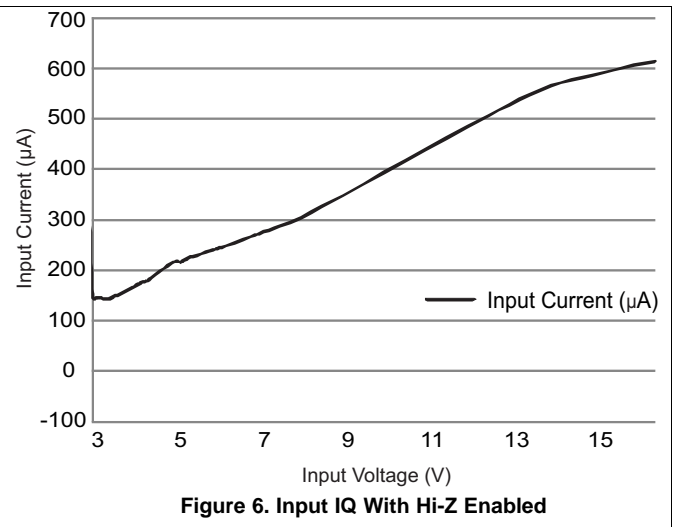
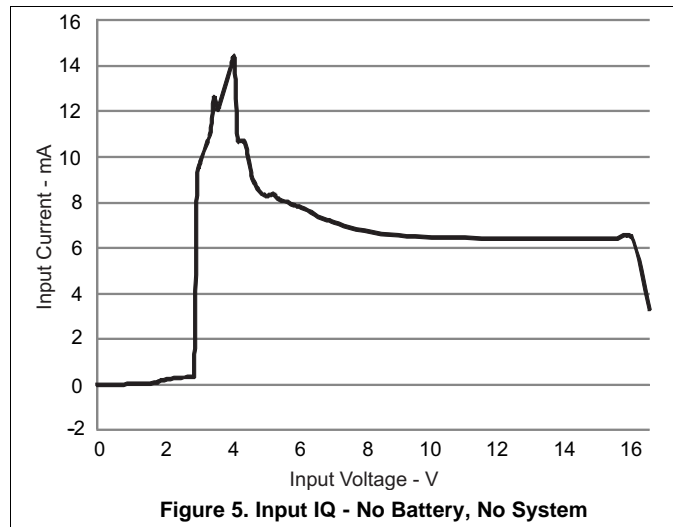

Figure 4. VBAT Accuracy vs IBAT – 4.2-V Setting

Typical Characteristics (continued)



9 Detailed Description

9.1 Overview

The bq24260/1/1M/2 is a highly integrated single-cell Li-Ion battery charger and system power-path management device targeted for space-limited, portable applications with high capacity batteries. The single-cell charger has a single input that supports operation from either a USB port or wall adapter supply for a versatile solution.

The power-path management feature allows the bq24260/1/1M/2 to power the system from a high efficiency DC-DC converter while simultaneously and independently charging the battery. The charger monitors the battery current at all times and reduces the charge current when the system load requires current above the input current limit or the adapter cannot support the required load, causing the adapter voltage to fall (V_{IN_DPM}). This allows for proper charge termination and timer operation. The system voltage is regulated to the battery voltage but will not drop below 3.5 V (V_{MINSYS}). This minimum system voltage support enables the system to run with a defective or absent battery pack and enables instant system turnon even with a totally discharged battery or no battery. The power-path management architecture also permits the battery to supplement the system current requirements when the adapter cannot deliver the peak system currents. The power-path feature coupled with V_{IN_DPM} , enables the use of many adapters with no hardware change. The charge parameters are programmable using the I²C interface. To support USB OTG applications, the bq24260/1/1M/2 is configurable to boost the battery voltage to 5 V at the input. In this mode, the bq24260/1/1M/2 supplies up to 1 A and operates with battery voltages down to 3.3 V.

The battery is charged using a standard Li-Ion charge profile with three phases: precharge, constant current, and constant voltage. In all charge phases, an internal control loop monitors the IC junction temperature and reduces the input current to prevent the junction temperature from rising above 125°C. Additionally, a voltage-based, JEITA-compatible battery pack thermistor monitoring input (TS) is included that monitors battery temperature and automatically changes charge parameters to prevent the battery from charging outside of its safe temperature range.

9.2 Functional Block Diagram

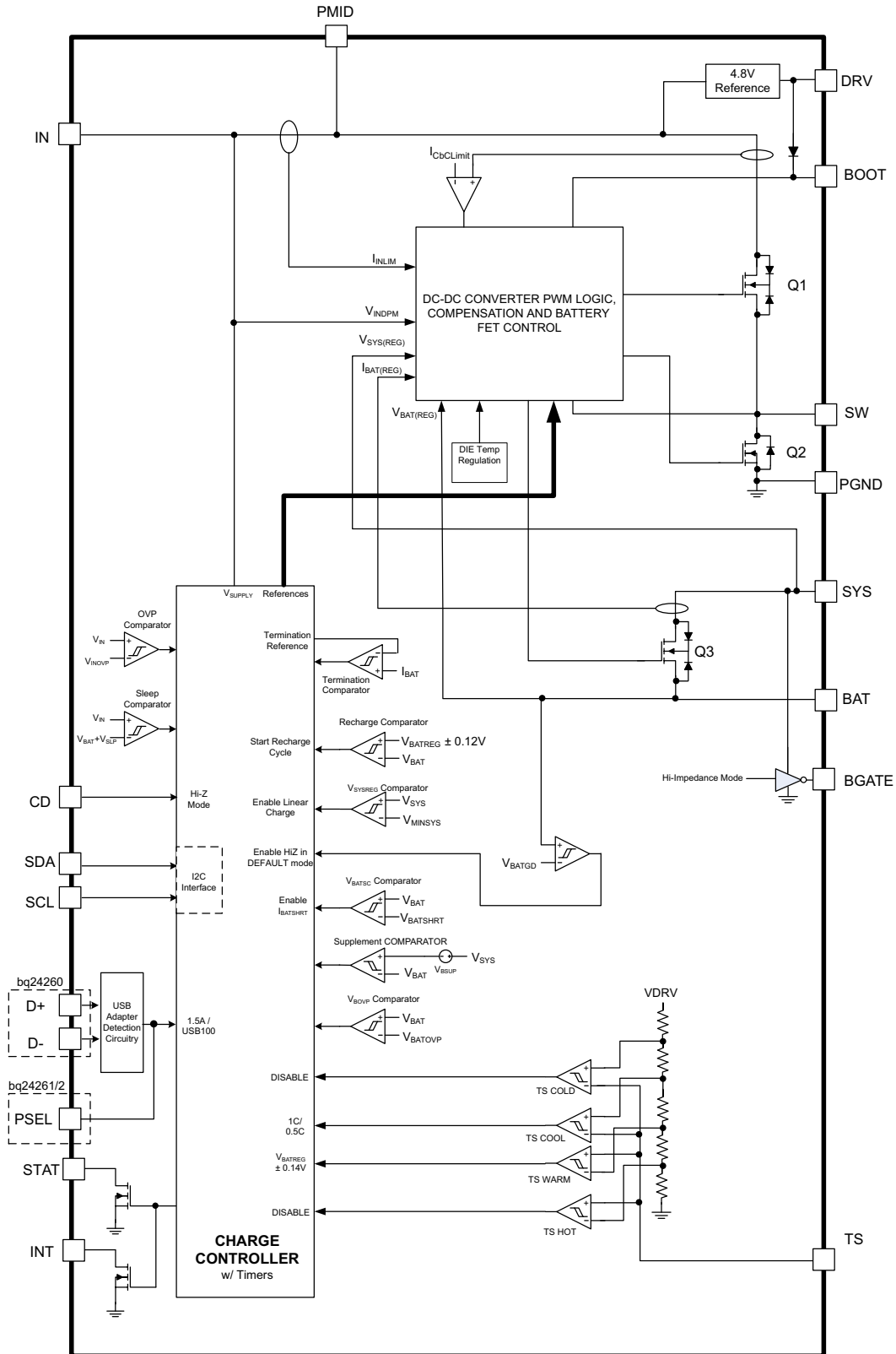

Figure 7. Block Diagram in Charging Mode

Functional Block Diagram (continued)

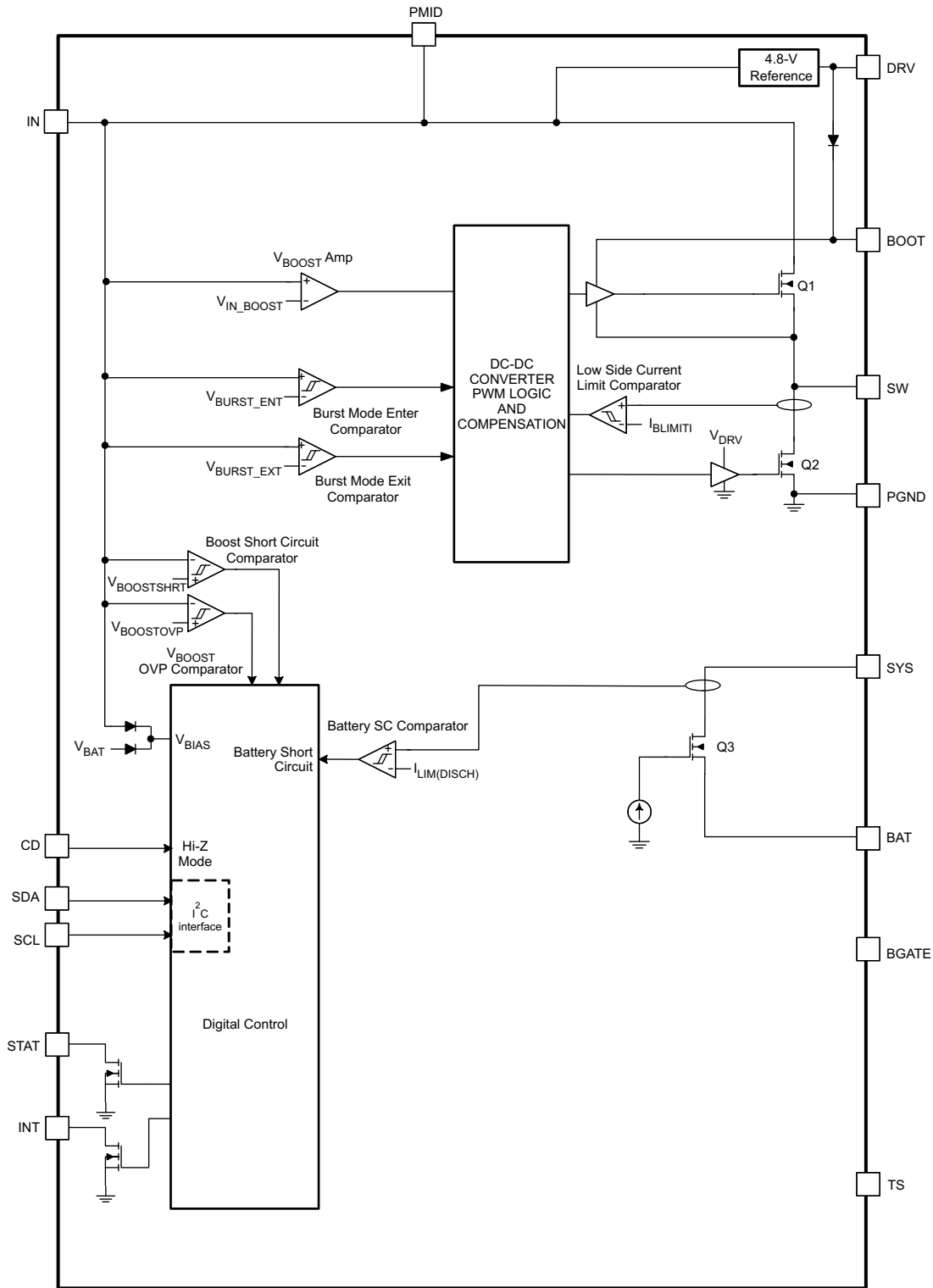

Figure 8. Block Diagram in Boost Mode

9.3 Feature Description

The bq24260/1/1M/2 is a highly integrated single-cell Li-Ion battery charger and system power path management device that supports operation from either a USB port or wall adapter supply. The power path feature allows the bq24260/1/1M/2 to power the system from a high efficiency DC-DC converter while simultaneously and independently charging the battery. The power path also permits the battery to supplement the system current requirements when the adapter cannot. Many features are programmable using the I²C interface. To support USB OTG applications, the bq24260/1/1M/2 is configurable to boost the battery voltage to 5 V and supply up to 1 A at the input. The battery is charged with three phases: precharge, constant current and constant voltage. Thermal regulation prevents the die temperature from exceeding 125°C. Additionally, a JEITA compatible battery pack thermistor monitoring input (TS) is included to prevent the battery from charging outside of its safe temperature range.

[Device Functional Modes](#) explains these features in detail.

9.4 Device Functional Modes

9.4.1 High Impedance Mode

High Impedance mode (Hi-Z mode) is the low quiescent current state for the bq24260/1/1M/2. During Hi-Z mode, the buck converter is off, and the battery FET and BGATE are on. SYS is powered by BAT. The bq24260/1/1M/2 is in Hi-Z mode when $V_{IN} < V_{UVLO}$, the HZ_MODE bit in the I²C is '1' or the CD terminal is driven high. Hi-Z mode resets the safety timer.

The bq24260/1/1M/2 contains a CD input that is used to disable the IC and place the bq24260/1/1M/2 into high-impedance mode. Drive CD low to enable the bq24260/1/1M/2 and enter normal operation. Drive CD high to disable charge and place the bq24260/1/1M/2 into high-impedance mode. CD is internally pulled down to PGND with a 100-k Ω resistor. When exiting Hi-Z mode, charging resumes in approximately 110 ms.

9.4.2 Battery Only Connected

When the battery is connected with no input source, the battery FET turns on, connecting BAT and SYS, after the battery voltage rises above $V_{BATUVLO}$ and the deglitch time, $t_{DGL(BAT)}$. In this mode, the current is not regulated; however, there is a short-circuit current limit. If the short-circuit limit ($I_{LIM(DISCHG)}$) is reached the deglitch time ($t_{DGL(SC)}$), the battery FET is turned off for the recovery time ($t_{REC(SC)}$). After the recovery time, the battery FET is turned on to test and see if the short has been removed. If it has not, the FET turns off and the process repeats until the short is removed. This process protects the internal FET from overcurrent. If an external FET is used for discharge, the body diode prevents the load on SYS from being disconnected from the battery and $t_{DGL(BAT)}$ is not applicable.

9.4.3 Input Connected

9.4.3.1 Input Voltage Protection in Charge Mode

9.4.3.1.1 Sleep Mode

The bq24260/1/1M/2 enters the low-power sleep mode if the voltage on V_{IN} falls below sleep-mode entry threshold, $V_{BAT} + V_{SLP}$, and V_{IN} is higher than the undervoltage lockout threshold, V_{UVLO} . In sleep mode, the input is isolated from the battery. This feature prevents draining the battery during the absence of V_{IN} . When $V_{IN} < V_{BAT} + V_{SLP}$, the bq24260/1/1M/2 turns off the PWM converter, turns the battery FET and BGATE on, sends a single 128- μ s pulse on the STAT and INT outputs and the STATx and FAULT_x bits of the status registers are updated in the I²C. Once $V_{IN} > V_{BAT} + V_{SLP}$, the STATx bits are cleared and the device initiates a new charge cycle. The FAULT_x bits are not cleared until they are read in the I²C and the sleep condition no longer exists.

Device Functional Modes (continued)

9.4.3.1.2 Input Voltage Based Dynamic Power Management (V_{IN} -DPM)

During normal charging process, if the input power source is not able to support the programmed or default charging current, the supply voltage decreases. Once the supply drops to V_{IN_DPM} (default 4.2 V), the charge current limit is reduced to prevent the further drop of the supply. When the IC enters this mode, the charge current is lower than the set value and the DPM_STATUS bit is set. This feature ensures IC compatibility with adapters with different current capabilities without a hardware change. Figure 9 shows the V_{IN} -DPM behavior to a current limited source. In this figure the input source has a 2-A current limit and the device is charging at 1 A. A 2.5-A load then occurs on V_{SYS} causing the adapter to hit its current limit and collapse, while V_{SYS} goes from $V_{SYSREG(LO)}$ to V_{MINSYS} . If the 2X timer is set, the safety timer is extended while V_{IN} -DPM is active. Additionally, termination is disabled.

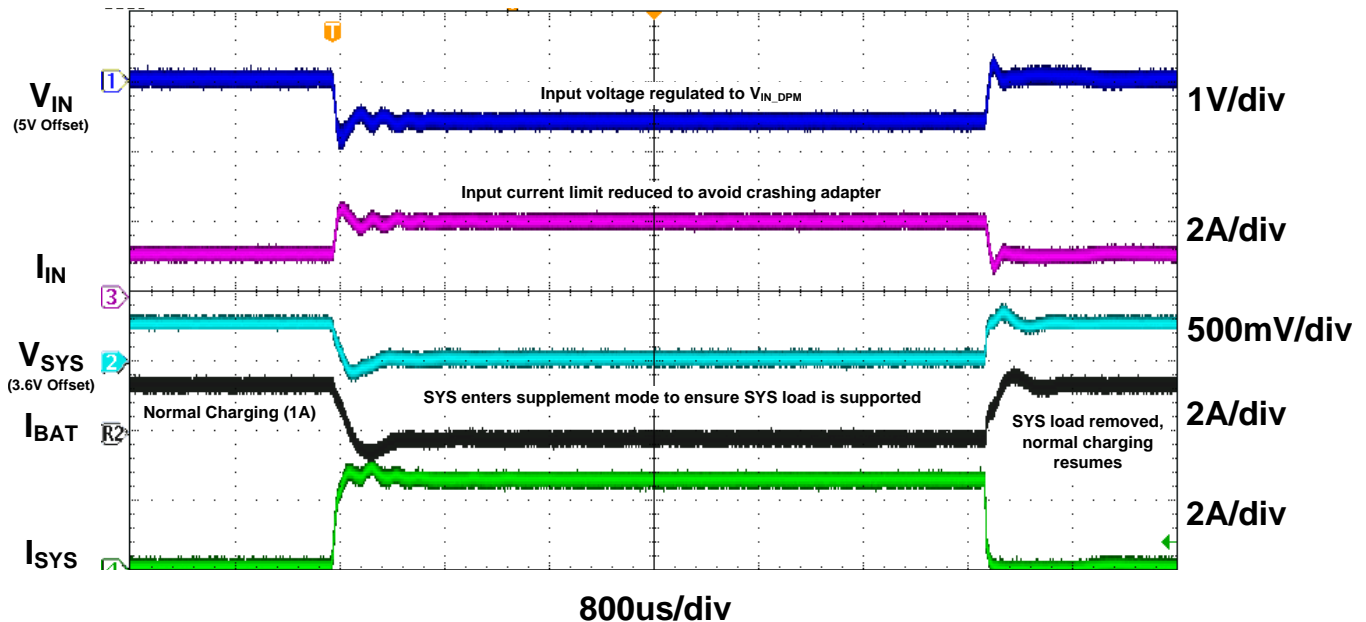

Figure 9. bq24260/1/1M/2 V_{IN} -DPM

9.4.3.1.3 Input Overvoltage Protection

The built-in input overvoltage protection protects the bq24260/1/1M/2 and downstream components connected to SYS and/or BAT against damage from overvoltage on the input supply (Voltage from V_{IN} to PGND). When $V_{IN} > V_{OVP}$, the bq24260/1/1M/2 turns off the PWM converter immediately. After the deglitch time $t_{DGL(BUCK_OVP)}$, an OVP fault is determined to exist. During the OVP fault, the bq24260/1/1M/2 turns the battery FET and BGATE on, sends a single 128- μ s pulse on the STAT and INT outputs, and the STATx and FAULT_x bits are updated in the I²C. Once the OVP fault is removed, the STATx bits are cleared and the device returns to normal operation. The FAULT_x bits are not cleared until they are read in the I²C after the OVP condition no longer exists.

The OVP threshold for the bq24260 is 10.5 V for operation from standard adapters while the bq24261/1M is set to 14 V to enable operation from 12-V sources. The bq24262 OVP is set to 6.5 V to operate from standard USB sources.

9.4.3.2 Charge Profile

When a valid input source is connected ($V_{IN} > V_{UVLO}$ and $V_{BAT} + V_{SLP} < V_{IN} < V_{OVP}$), the \overline{CE} bit in the control register determines whether a charge cycle is initiated. By default, the bq24260 and bq24262 enable the charge cycle when a valid input source is connected while the bq24261/1M do not ($\overline{CE} = 1$ by default). When the \overline{CE} bit is 1 and a valid input source is connected, the battery FET is turned off and the SYS output is regulated to $V_{SYSREG(HI)}$. A charge cycle is initiated when the \overline{CE} bit is written to a 0.

Device Functional Modes (continued)

The bq24260/1/1M/2 supports a precision Li-Ion or Li-Polymer charging system for single-cell applications. Charging is done through the internal battery MOSFET. There are 6 loops that influence the charge current; constant current loop (CC), constant voltage loop (CV), thermal regulation loop, minimum system voltage loop (MINSYS), input current limit and V_{IN-DPM} . During the charging process, all six loops are enabled and the one that is dominant takes control. The minimum system output feature regulates the system voltage to $V_{SYSREG(LO)}$, so that startup is enabled even for a missing or deeply discharged battery. Figure 10 shows a typical charge profile including the minimum system output voltage feature.

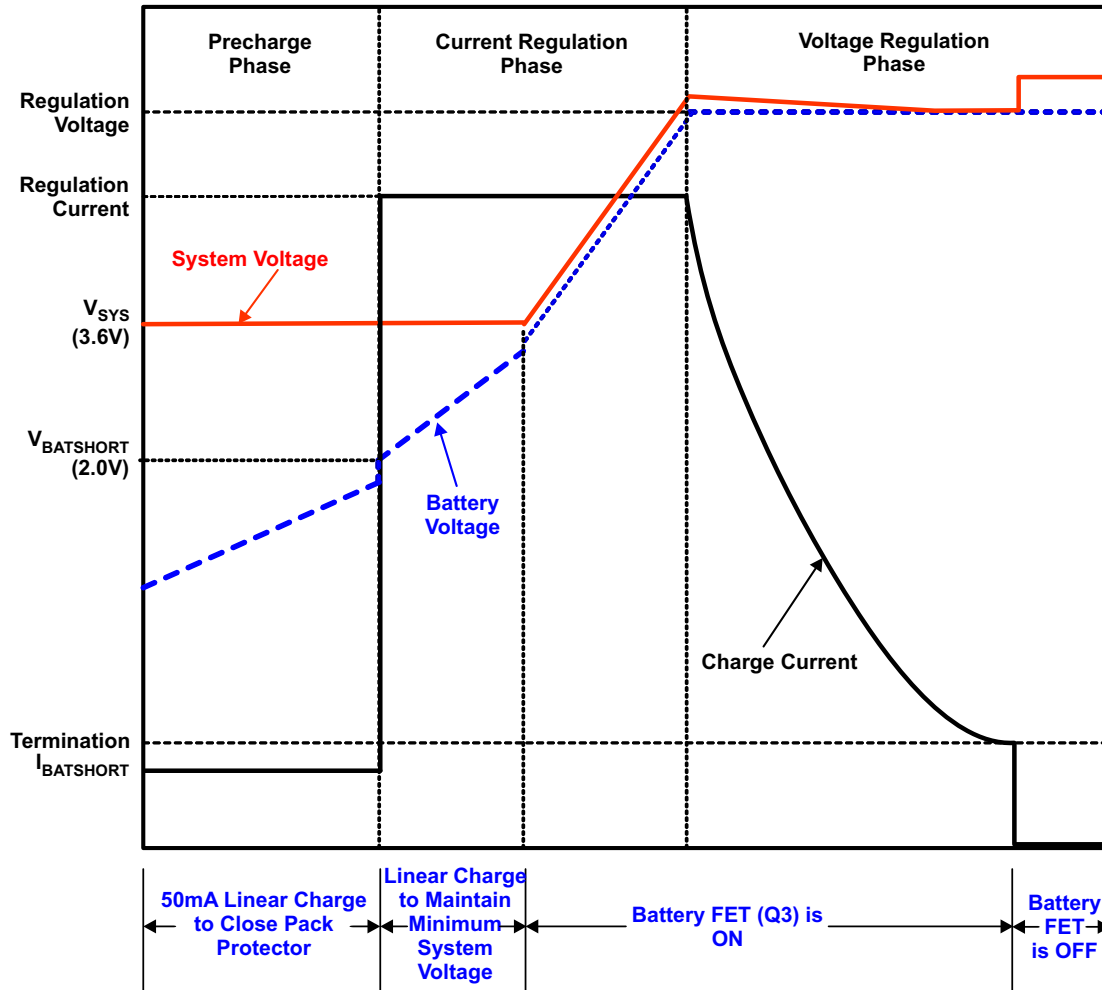

Figure 10. Typical Charging Profile of bq24260/1/1M/2 With Termination Enabled

9.4.4 Battery Charging Process

When the battery is deeply discharged or shorted, the bq24260/1/1M/2 applies a $I_{BATSHRT}$ current to close the battery protector switch and bring the battery voltage up to acceptable charging levels. During this time, the battery FET is off and the system output is regulated to $V_{SYSREG(LO)}$. Once the battery rises above $V_{BATSHRT}$, the charge current is regulated to the value set in the I²C register. The battery FET is linearly regulated to maintain the system voltage at $V_{SYSREG(LO)}$. Under normal conditions, the time spent in this region is a very short percentage of the total charging time, so the linear regulation of the charge current does not affect the overall charging efficiency for very long. If the die temperature does heat up, the thermal regulation loop reduces the input current to maintain a die temperature at 125°C. If the current limit for the SYS output is reached (limited by

Device Functional Modes (continued)

the input current limit, V_{IN-DPM} , or 100% duty cycle), the SYS output drops to the V_{MINSYS} output voltage. When this happens, the charge current is reduced to ensure the system is supplied with all the current that is needed while maintaining the minimum system voltage. If the charge current is reduced to 0 mA, pulling further current from SYS causes the output to fall to the battery voltage and enter supplement mode (see [Dynamic Power-Path Management](#) for more details).

Once the battery is charged enough that the system voltage rises above $V_{SYSREG(LO)}$ (approximately 3.5 V), the battery FET is turned on fully and the battery is charged with the full programmed charge current set by the I²C interface, I_{CHARGE} . The charge current is regulated to I_{CHARGE} until the voltage between BAT and PGND reaches the regulation voltage. The voltage between BAT and PGND is regulated to V_{BATREG} (CV mode) while the charge current naturally tapers down as shown in [Figure 10](#). During CV mode, the SYS output remains connected to the battery. The impedance of the battery FET is increased to 4x of the fully on value when IBAT falls below approximately 350 mA to provide increased accuracy during termination. This will show a small rise in the SYS voltage when the $R_{DS(ON)}$ increases below approximately 350 mA.

When termination is enabled (TE bit is '1'), the bq24260/1/1M/2 monitors the charging current during the CV mode. Once the charge current tapers down to the termination threshold, I_{TERM} , and the battery voltage is above the recharge threshold, the bq24260/1/1M/2 terminates charge, turns off the battery charging FET and enters battery detection (see Battery Detection section for more details). The system output is regulated to the $V_{SYSREG(HI)}$ and supports the full current available from the input. The battery supplement mode is available to supply any SYS load that cannot be supported by the input source (see [Dynamic Power-Path Management](#) for more details). The termination current level is programmable. To disable the charge current termination, the host sets the charge termination bit (TE) of charge control register to 0. Refer to I²C section for details. When termination is disabled, V_{BAT} is continuously regulated to V_{BATREG} . Termination is also disabled when any loop is active other than CC or CV. This includes V_{INDPM} , input current limit, or thermal regulation. Termination is also disabled during TS warm/cool conditions and when the LOW_CHG bit is set to '1'.

A charge cycle is initiated when one of the following conditions is detected:

1. The battery voltage falls below the $V_{BATREG}-V_{RCH}$ threshold.
2. IN Power-on reset (POR)
3. CE bit toggle or RESET bit is set (Host controlled)
4. CD terminal is toggled

9.4.5 Charge Time Optimizer

The CC to CV transition is enhanced in the bq24260/1/1M/2 architecture. The "knee" between CC and CV is sharp. This enables the charger to remain in CC mode as long as possible before beginning to taper the charge current (CV mode). This provides a decrease in charge time as compared to older topologies.

9.4.6 Battery Detection

When termination conditions are met, a battery detection cycle is started. During battery detection, I_{DETECT} is pulled from V_{BAT} for $t_{DETECT(SNK)}$ to verify there is a battery. If the battery voltage remains above $V_{DET(SINK)}$ for the full duration of $t_{DETECT(SNK)}$, a battery is determined to present and the IC enters "Charge Done". If V_{BAT} falls below $V_{DET(SINK)}$, a "Battery Not Present" fault is signaled, the charge parameters are reset (V_{BATREG} , I_{CHARGE} and I_{TERM}) and battery detection continues. The next cycle of battery detection, the bq24260/1/1M/2 turns on $I_{BATSHRT}$ for $t_{DETECT(SRC)}$. If V_{BAT} rises to $V_{DET(SRC1)}$, the current source is turned off and a "No Battery" condition is registered. In order to keep VBAT high enough to close the battery protector, the current source turns on if V_{BAT} falls to $V_{DET(SRC2)}$. The source cycle continues for $t_{DETECT(SRC)}$. After $t_{DETECT(SRC)}$, the battery detection continues through another current sink cycle. Battery detection continues until charge is disabled, the bq24260/1/1M/2 enters hi-z mode or a battery is detected. Once a battery is detected, the fault status clears and a new charge cycle begins. With no battery connected, the BAT output will transition from VRCH to PGND with a high period of $t_{DETECT(SRC)}$ and a low period of $t_{DETECT(SNK)}$. See [Figure 30](#) in [Application Curves](#). Battery detection is not performed when termination is disabled.

Device Functional Modes (continued)

9.4.7 Battery Overvoltage Protection (BOVP)

If the battery is ever above the battery OVP threshold (V_{BOVP}), the battery OVP circuit shuts the PWM converter off and the battery FET is turned on to discharge the battery to safe operating levels. A battery OVP most commonly occurs when the bq24260/1/1M/2 returns to DEFAULT mode after a watchdog timer expiration or RESET bit written to '1'. In this condition, the V_{BATREG} is reset and may be below the battery voltage. Other conditions may be when the input is initially plugged in before I²C communication is established or TS WARM conditions or when writing the V_{BATREG} to less than the battery voltage. The battery OVP condition is cleared when the battery voltage falls below the hysteresis of V_{BOVP} either by the battery discharging or writing the V_{BATREG} to a higher value. When a battery OVP event exists for $t_{DGL(BOVP)}$, the bq24260/1/1M/2 turns the battery FET and BGATE on, sends a single 128 μ s pulse on the STAT / INT outputs and the STATx and FAULT_x bits are updated in the I²C. Once the BOVP fault is removed, the STATx bits are cleared and the device returns to normal operation. The FAULT_x bits are not cleared until they are read in the I²C after the BOVP condition no longer exists.

9.4.8 Dynamic Power-Path Management

The bq24260/1/1M/2 features a SYS output that powers the external system load connected to the battery. This output is active whenever a valid source is connected to IN or BAT. When $V_{SYS} > V_{SYSREG(LO)}$, the SYS output is connected to V_{BAT} . If the battery voltage falls to V_{MINSYS} , V_{SYS} is regulated to the $V_{SYSREG(LO)}$ threshold to maintain the system output even with a deeply discharged or absent battery. In this mode, the SYS output voltage is regulated by the buck converter and the battery FET is linearly regulated to regulate the charge current into the battery. The current from the supply is shared between charging the battery and powering the system load at SYS. The dynamic power-path management (DPPM) circuitry of the bq24260/1/1M/2 monitors the current limits continuously and if the SYS voltage falls to the V_{MINSYS} threshold, it adjusts charge current to maintain the minimum system voltage and supply the load on SYS. If the charge current is reduced to zero and the load increases further, the bq24260/1/1M/2 enters battery supplement mode. During supplement mode, the battery FET is turned on and $V_{BAT} = V_{SYS}$ while the battery supplements the system load.

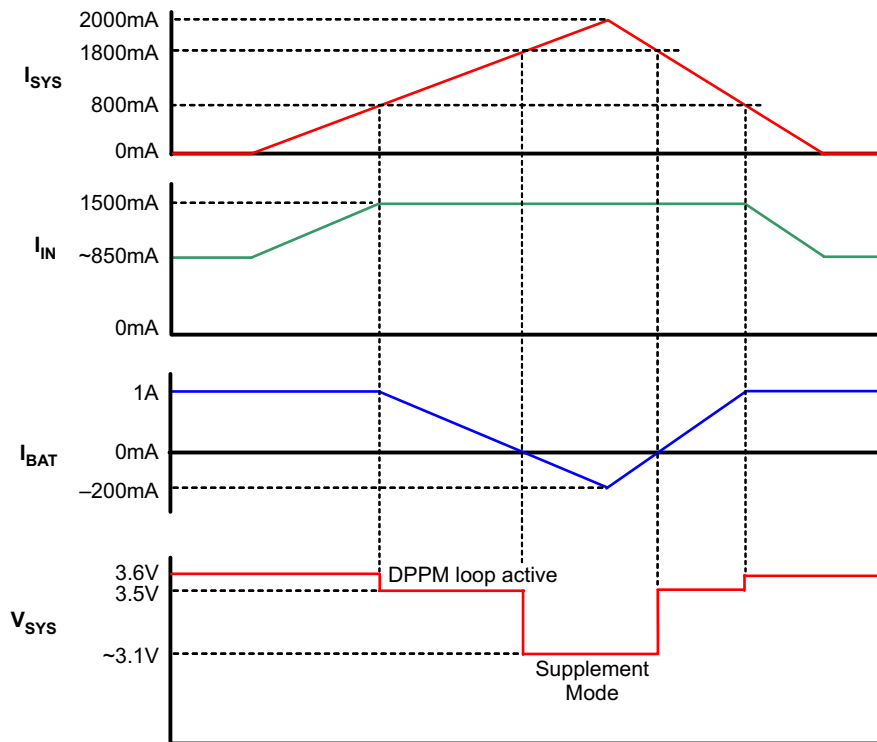

Figure 11. Example DPPM Response ($V_{Supply}=5V$, $V_{BAT} = 3.1V$, 1.5A Input Current Limit)

Device Functional Modes (continued)

9.4.9 Battery Discharge FET (BGATE)

The bq24260/1/1M/2 contains a MOSFET driver to drive an external discharge FET between the battery and the system output. This external FET provides a low impedance path for supplying the system from the battery. Connect BGATE to the gate of the external discharge P-channel MOSFET. BGATE is on (low) under the following conditions:

1. No input supply connected.
2. HZ_MODE = 1
3. CD terminal = 1

9.4.10 DEFAULT Mode

DEFAULT mode is used when I²C communication is not available. DEFAULT mode is entered in the following situations:

1. When the charger is enabled and $V_{BAT} < V_{BATGD}$ before I²C communication is established
2. When the watchdog timer expires without a reset from the I²C interface
3. The RESET bit is written in the I²C register

In DEFAULT mode, the I²C registers are reset to the default values. The 2-minute safety timer is reset and starts when DEFAULT mode is entered if a charge cycle is underway. The default value for V_{BATREG} is 3.6 V for the bq24260/1/1M and 4.2 V for the bq24262. The default value for I_{CHARGE} is 1 A. For the bq24260, the input current limit is determined by the D+/D- detection (See *D+/D- Based Adapter Detection* section). For the bq24261, bq24261M and bq24262, the input current limit in DEFAULT mode is set by PSEL. (See *Power Source Selector Input* section) DEFAULT mode is exited by writing to the I²C interface. Note that if termination is enabled and charging has terminated, a new charge cycle is NOT initiated when entering DEFAULT mode.

9.4.11 Good Battery Monitor

The bq2426x contains a good battery monitor circuit that places the bq2426x into hi-z mode if the battery voltage is above the V_{BATGD} threshold while in DEFAULT mode. This function is used to enable compliance to the battery charging standard that prevents charging from an un-enumerated USB host while the battery is above the good battery threshold. If the bq24260/1/1M/2 is in HOST mode, it is assumed that USB host has been enumerated and the good battery circuit has no effect on charging. Any write to the I²C places the bq24260/1/1M/2 in HOST mode and clears the high-impedance mode condition. The HZ_MODE bit is not updated during this condition.

9.4.12 D+/D- Based Adapter Detection (D+/D-, bq24260 only)

The bq24260 contains a D+/D- based adapter detection circuit that is used to program the input current limit for the input during DEFAULT mode. D+/D- is only performed in DEFAULT mode unless forced by the D+/D-_EN bit in host mode.

By default the input current limit is set to 100 mA. During DEFAULT mode, when the input source is connected, the bq24260 performs an adapter detection to determine if it is connected to a USB port or dedicated charger. The adapter detection starts with a connection detection as described in the USB Battery Charging Specification ver 1.2 (BC1.2). Once a connection is detected, the adapter detection is performed. If a connection is not detected within 500ms, the adapter detection begins. The adapter detection runs as described in BC1.2. If a CDP/DCP is detected, the input current limit is increased to 1.5 A. If an SDP is detected, the current limit remains at 100 mA, until changed in the I²C.

D+/D- is initiated at any time by the host by setting the D+/D- EN bit in the I²C to 1. After detection is complete the D+/D- EN bit is automatically reset to 0 and the detection circuitry is disconnected from the D+ D- terminals to avoid interference with USB data transfer. When a command is written to change the input current limit in the I²C, this overrides the current limit selected by D+/D- detection.

Device Functional Modes (continued)

9.4.13 Power Source Selector Input (PSEL, bq24261/2 only)

The bq24261/2 contains a PSEL input that is used to program the input current limit during DEFAULT mode. Drive PSEL high to indicate a USB source is connected to the input and program the 100 mA (bq24261/1M) or 500mA (bq24262) current limit for IN. Drive PSEL low to indicate that an AC Adapter is connected to the input. When PSEL is low, the IC starts up with a 1.5-A input current limit. Once an I²C write is done and the device is in HOST mode, the PSEL has no effect on the input current limit until the watchdog timer expires and returns thebq24260/1/1M/2 to DEFAULT mode.

9.4.14 Safety Timer and Watchdog Timer in Charge Mode (bq24260/1/1M only)

At the beginning of charging process, the bq24260/1/1M starts the safety timer. This timer is active during the entire charging process. If charging has not terminated before the safety timer expires, the IC enters suspend mode where charging is disabled. When a safety timer fault occurs, a single 128 μ s pulse is sent on the STAT and INT outputs and the STATx and FAULT_x bits of the status registers are updated in the I²C. The \overline{CE} bit, Hi-Z mode, or power must be toggled in order to clear the safety timer fault. The safety timer duration is selectable using the TMR_X bits in the Safety Timer Register/ NTC Monitor register. When the safety timer is active, changing the safety timer duration resets the safety timer. The bq24260/1/1M also contains a 2X_TIMER bit that enables the 2x timer function to prevent premature safety timer expiration when the charge current is reduced by a load on SYS or a NTC condition. When 2X_TIMER is enabled, the timer runs at half speed when any loop is active other than CC or CV. This includes V_{INDPM} , input current limit, or thermal regulation. The timer also runs at half speed during TS warm/cool conditions and when the LOW_CHG bit is set to 1.

In addition to the safety timer, the bq24260/1/1M contains a 30-second ($t_{WATCHDOG}$) watchdog timer that monitors the host through the I²C interface. Once a write is performed on the I²C interface, a watchdog timer is started. The watchdog timer is reset by the host using the I²C interface. This is done by writing a 1 to the reset bit (TMR_RST) in the control register. The TMR_RST bit is automatically set to 0 when the watchdog timer is reset. This process must continue as long as the input is connected in order to maintain the register contents. If the watchdog timer expires, the IC enters DEFAULT mode where the default register values are loaded, the safety timer restarts at 2 minutes once charging continues. The I²C may be accessed again to reinitialize the desired values and restart the watchdog timer. The watchdog timer flow chart is shown in [Figure 12](#).

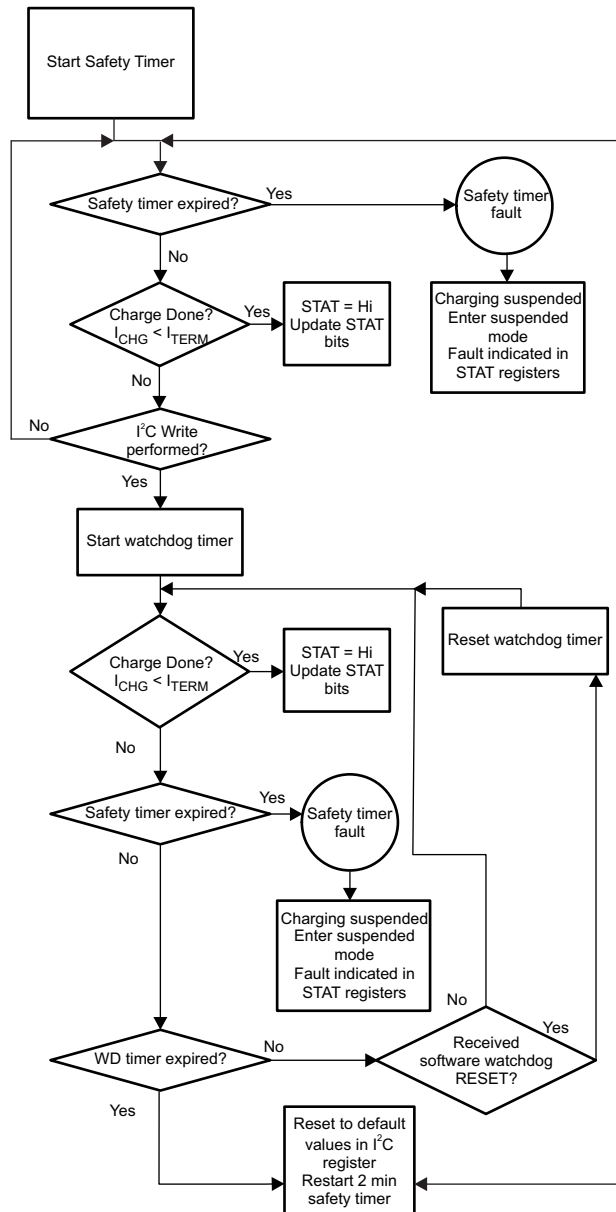
Device Functional Modes (continued)

Figure 12. Watchdog Timer Flow Chart for bq24260/1/1M
9.4.15 LDO Output (DRV)

The bq24260/1/1M/2 contains a linear regulator (DRV) that is used to supply the internal MOSFET drivers and other circuitry. Additionally, DRV supplies up to 10mA external loads to power the STAT LED or the USB transceiver circuitry. The maximum value of the DRV output is 5.3 V so it ideal to protect voltage sensitive USB circuits. The LDO is on whenever a supply is connected to the input of the bq24260/1/1M/2. The DRV is disabled under the following conditions:

- $V_{\text{SUPPLY}} < UVLO$
- $V_{\text{SUPPLY}} < V_{\text{BAT}} + V_{\text{SLP}}$
- Thermal Shutdown

Device Functional Modes (continued)

9.4.16 External NTC Monitoring (TS)

The I²C interface allows the user to easily implement the JEITA standard for systems where the battery pack thermistor is monitored by the host. Additionally, the bq24260/1/1M/2 provides a flexible, voltage based TS input for monitoring the battery pack NTC thermistor. The voltage at TS is monitored to determine that the battery is at a safe temperature during charging. The JEITA specification is shown in Figure 13.

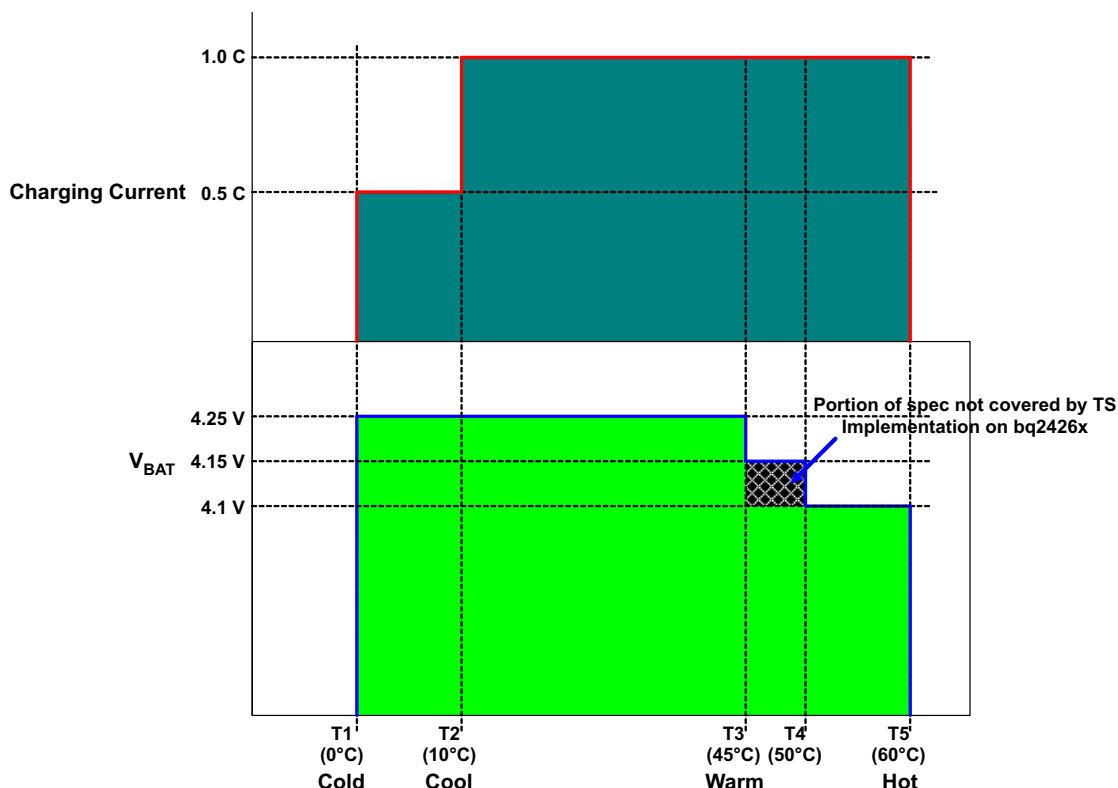

Figure 13. Charge Current During TS Conditions

To satisfy the JEITA requirements, four temperature thresholds are monitored; the cold battery threshold ($T_{NTC} < 0^{\circ}\text{C}$), the cool battery threshold ($0^{\circ}\text{C} < T_{NTC} < 10^{\circ}\text{C}$), the warm battery threshold ($45^{\circ}\text{C} < T_{NTC} < 60^{\circ}\text{C}$) and the hot battery threshold ($T_{NTC} > 60^{\circ}\text{C}$). These temperatures correspond to the V_{COLD} , V_{COOL} , V_{WARM} , and V_{HOT} thresholds in the EC table. Charging is suspended and timers are suspended when $V_{TS} < V_{HOT}$ or $V_{TS} > V_{COLD}$. When $V_{COOL} < V_{TS} < V_{COLD}$, the charging current is reduced to half of the programmed charge current. When $V_{HOT} < V_{TS} < V_{WARM}$, the battery regulation voltage is reduced by 140mV from the programmed regulation threshold. The TS function is disabled by connecting TS directly to DRV ($V_{TS} > V_{TSOFF}$).

The TS function is voltage based for maximum flexibility. Connect a resistor divider from DRV to GND with TS connected to the center tap to set the threshold. The connections are shown in Figure 14. The resistor values are calculated using the following equations:

$$RLO = \frac{V_{DRV} \times RCOLD \times RHOT \times \left[\frac{1}{V_{COLD}} - \frac{1}{V_{HOT}} \right]}{RHOT \times \left[\frac{V_{DRV}}{V_{HOT}} - 1 \right] - RCOLD \times \left[\frac{V_{DRV}}{V_{COLD}} - 1 \right]} \quad (1)$$

$$RHI = \frac{\frac{V_{DRV}}{V_{COLD}} - 1}{\frac{1}{RLO} + \frac{1}{RCOLD}}$$

Device Functional Modes (continued)

where

- $V_{COLD} = 0.60 \times V_{DRV}$
- $V_{HOT} = 0.30 \times V_{DRV}$

$$RCOOL = \frac{RLO \times RHI \times 0.564}{RLO - RLO \times 0.564 - RHI \times 0.564} \quad (2)$$

$$RWARM = \frac{RLO \times RHI \times 0.383}{RLO - RLO \times 0.383 - RHI \times 0.383} \quad (3)$$

where

- RHOT is the NTC resistance at the hot temperature
- RCOLD is the NTC resistance at cold temperature

The WARM and COOL thresholds are not independently programmable. The COOL and WARM NTC resistances for a selected resistor divider are calculated using [Equation 3](#) and [Equation 4](#).

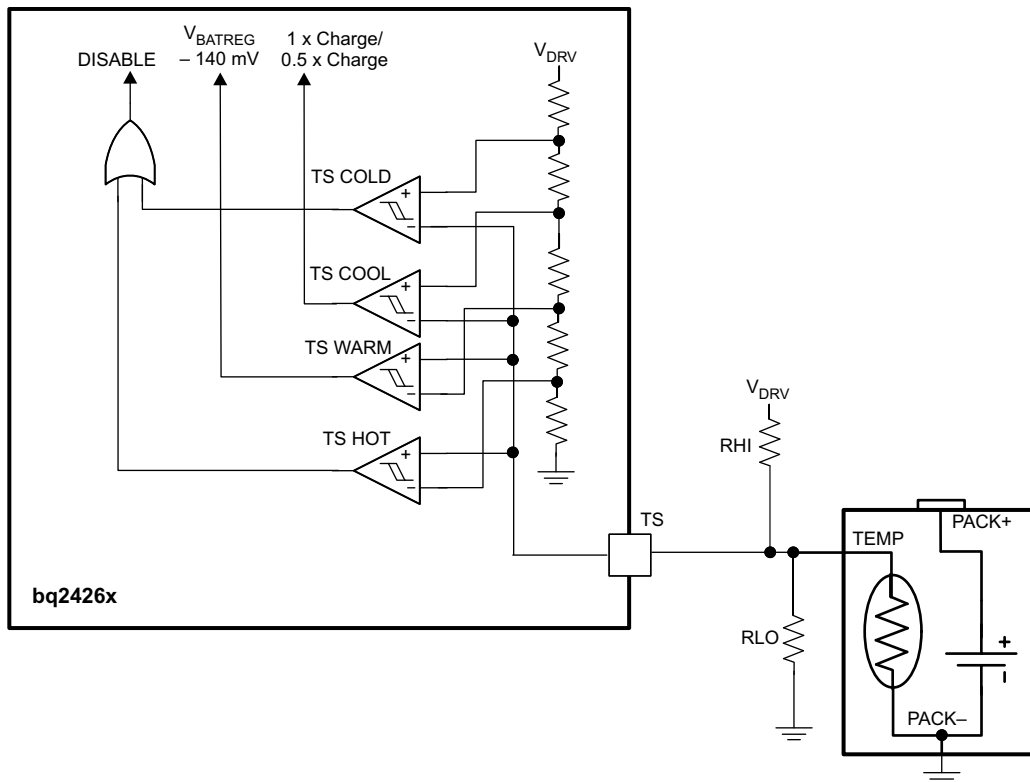
Figure 14. TS Circuit
9.4.17 Thermal Regulation and Protection

During the charging process, to prevent overheating in the chip, bq24260/1/1M/2 monitors the junction temperature, T_J , of the die and reduces the input current once T_J reaches the thermal regulation threshold, T_{REG} . The input current is reduced to zero when the junction temperature increases about 10°C above T_{REG} . Once the input current is reduced to 0, the system current is reduced while the battery supplements the load to supply the system. When the input current is completely reduced to 0 and $T_J > 125^\circ\text{C}$, this may cause a thermal shutdown of the bq24260/1/1M/2 if the die temperature rises too high. At any state, if T_J exceeds T_{SHTDWN} , bq24260/1/1M/2 stops charging and disables the buck converter. During thermal shutdown mode, PWM is turned off, all timers are suspended, a single 128- μs pulse is sent on the STAT and INT outputs, and the STATx and FAULT_x bits of the status registers are updated in the I²C. The charge cycle resumes when T_J falls below T_{SHTDWN} by approximately 10°C .

Device Functional Modes (continued)

9.4.18 Charge Status Outputs (STAT, INT)

The STAT/INT output is used to indicate operation conditions for bq24260/1/1M/2. STAT/INT is pulled low during charging when EN_STAT bit in the control register is set to 1. When charge is complete or disabled, STAT/INT is high impedance. When a fault occurs, a 128- μ s pulse (interrupt) is sent out to notify the host. The status of STAT/INT during different operation conditions is summarized in [Table 1](#). STAT/INT drives an LED for visual indication or can be connected to the logic rail for host communication. The EN_STAT bit in the control register is used to enable/disable the charge status for STAT/INT. The interrupt pulses are unaffected by EN_STAT and will always be shown.

Table 1. STAT Terminal Summary

CHARGE STATE	STAT and INT BEHAVIOR
Charge in progress and EN_STAT=1	Low
Other normal conditions	High-Impedance
Charge mode faults: Timer faults, sleep mode, VIN overvoltage, VIN < UVLO or Sleep mode, BOVP, thermal shutdown, No Battery and Battery Temperature faults	128- μ s pulse, then High Impedance

9.4.19 Boost Mode Operation

In HOST mode, when the operation mode bit (BOOST_EN) in the control register is set to 1, bq24260/1/1M/2 operates in boost mode and delivers 5 V to IN to supply USB OTG devices connected to the USB connector. Boost operation can start with VBAT between 3.45 V to 4.5 V, and will maintain boost output until VBAT falls to 3.3 V. IN supplies up to 1 A to power these devices. It is not recommended to operate boost mode when the battery voltage is less than 3.3 V. Proper operation is not ensured.

9.4.19.1 Chip Disable Input During Boost Mode (CD)

The bq24260/1/1M/2 contains a CD input that is used to disable the IC and place the bq24260/1/1M/2 into high-impedance mode. CD must be low to enter boost mode. Driving CD high during boost mode places the bq24260/1/1M/2 into hi-z mode and resets the BOOST_EN bit in the I²C. When CD is high, the buck converter is off, and the battery FET and BGATE are turned on. CD is internally pulled down to GND with a 100-k Ω resistor.

9.4.19.2 PWM Controller in Boost Mode

Similar to charge mode operation, in boost mode the IC switches at 1.5MHz to regulate the voltage at IN to 5 V. The voltage control loop is internally compensated to provide enough phase margin for stable operation with the full battery voltage range and up to 1 A.

In boost mode, the cycle-by-cycle current limit is set to 4 A or 2 A (depending on the I²C setting) to provide protection against short-circuit conditions. If the cycle-by-cycle current limit is active for 8 ms, an overload condition is detected and the device exits boost mode, and signals an overcurrent fault. Additionally, discharge current limit (I_{LIM(DISCHG)}) is active to protect the battery from overload. Synchronous operation and burst mode are used to maximize efficiency over the full load range.

The bq24260/1/1M/2 will not enter boost mode unless the IN voltage is less than the UVLO. When the boost function is enabled, the bq24260/1/1M/2 enters a linear mode to bring IN up to the battery voltage. Once V_{IN} > (V_{BAT} – 1 V), the bq24260/1/1M/2 begins switching and regulates IN up to 5 V. If V_{IN} does not rise to within 1 V of V_{BAT} within 8 ms, an overcurrent event is detected and boost mode is exited and a boost mode overcurrent event is announced, the BOOST_EN bit is reset to 0 and the STAT_x and FAULT_x bits in the Status/ Control register are updated.

9.4.19.3 Burst Mode During Light Load

In boost mode, the IC operates using burst mode to improve light load efficiency and reduce power loss. During boost mode, the PWM converter is turned off when the device reaches minimum duty cycle and the output voltage rises to V_{BURST(ENT)} threshold. This corresponds to approximately a 75-mA inductor current. The converter then restarts when V_{IN} falls to V_{BURST(EXT)}. See [Figure 38](#) in the [Application Curves](#) for an example waveform.

9.4.19.4 Watchdog Timer in Boost Mode

During boost mode, the watchdog timer is active. The watchdog timer works the same as in charge mode. Write a 1 to the TMR_RST reset bit in the control register. If the watchdog timer expires, the IC resets the EN_BOOST bit to 0, signals the fault pulse on the STAT and INT terminals. The FAULT_x bits read "Low Supply Fault" as this is a higher priority fault than the WD timer.

9.4.19.5 STAT/INT During Boost Mode

During boost mode, the STAT and INT outputs are high impedance. Under fault conditions, a 128- μ s pulse is sent out to notify the host of the error condition.

9.4.19.6 Protection in Boost Mode

9.4.19.6.1 Output Overvoltage Protection

The bq24260/1/1M/2 contains integrated overvoltage protection on the IN terminal. During boost mode, if an overvoltage condition is detected ($V_{IN} > V_{BOOSTOVP}$), after deglitch $t_{DGL(BOOST_OVP)}$, the IC turns off the PWM converter, resets EN_BOOST bit to 0, sets fault status bits and sends out a fault pulse on STAT and INT. The converter does not restart when VIN drops to the normal level until the EN_BOOST bit is reset to 1.

9.4.19.6.2 Output Overcurrent Protection

The bq24260/1/1M/2 contains overcurrent protection to prevent the device and battery damage when IN is overloaded. When an overcurrent condition occurs, the cycle-by-cycle current limit limits the current from the battery to the load. If the overload condition lasts for 8 ms, the overload fault is detected. When an overload condition is detected, the bq24260/1/1M/2 turns off the PWM converter, resets EN_BOOST bit to 0, sets the fault status bits and sends out the fault pulse on STAT and INT. The boost operation starts only after the fault is cleared and the EN_BOOST bit is reset to 1 using the I²C.

9.4.19.6.3 Battery Voltage Protection

During boost mode, when the battery voltage is below the minimum battery voltage threshold, $V_{BATUVLO}$, the IC turns off the PWM converter, resets EN_BOOST bit to 0, sets fault status bits and sends out a fault pulse on STAT and INT. Once the battery voltage returns to the acceptable level, the boost starts only after the EN_BOOST bit is set to 1. Proper operation below 3.3 V down to the $V_{BATUVLO}$ is not specified.

9.5 Programming

9.5.1 Serial Interface Description

The bq24260 uses an I²C compatible interface to program charge parameters. I²C is a 2-wire serial interface developed by NXP (formerly Philips Semiconductor, see I²C-Bus Specification, Version 5, October 2012). The bus consists of a data line (SDA) and a clock line (SCL) with pullup structures. When the bus is idle, both SDA and SCL lines are pulled high. All the I²C compatible devices connect to the I²C bus through open-drain I/O terminals, SDA and SCL. A master device, usually a microcontroller or a digital signal processor, controls the bus. The master is responsible for generating the SCL signal and device addresses. The master also generates specific conditions that indicate the START and STOP of data transfer. A slave device receives and/or transmits data on the bus under control of the master device.

The bq24260/1/1M/2 device works as a slave and supports the following data transfer modes, as defined in the I²C Bus™ Specification: standard mode (100 kbps) and fast mode (400 kbps). The interface adds flexibility to the battery charge solution, enabling most functions to be programmed to new values depending on the instantaneous application requirements. The I²C circuitry is powered from IN when a supply is connected. If the IN supply is not connected, the I²C circuitry is powered from the battery through BAT. The battery voltage must stay above $V_{BATUVLO}$ with no input connected in order to maintain proper operation.

The data transfer protocol for standard and fast modes is exactly the same; therefore, they are referred to as the F/S-mode in this document. The bq24260/1/1M/2 device only supports 7-bit addressing. The device 7-bit address is defined as '1101011' (0x6Bh).

To avoid I²C hang-ups, a timer (t_{I2C_RESET}) runs during I²C transactions. If the transaction takes longer than t_{I2C_RESET} , any additional commands are ignored and the I²C engine is reset. The timeout is reset with START and repeated START conditions and stops when a valid STOP condition is sent.

Programming (continued)

9.5.2 F/S Mode Protocol

The master initiates data transfer by generating a start condition. The start condition is when a high-to-low transition occurs on the SDA line while SCL is high, as shown in Figure 15. All I²C-compatible devices should recognize a start condition.

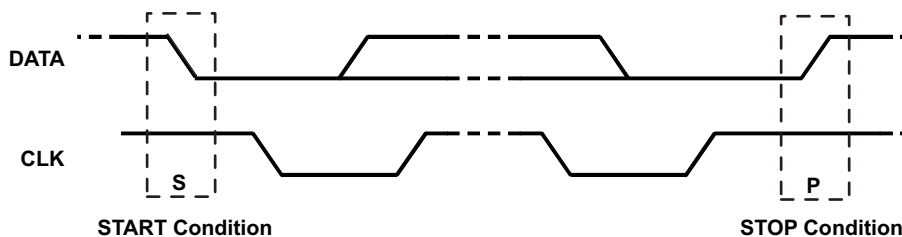

Figure 15. START and STOP Condition

The master then generates the SCL pulses, and transmits the 8-bit address and the read/write direction bit R/W on the SDA line. During all transmissions, the master ensures that data is valid. A valid data condition requires the SDA line to be stable during the entire high period of the clock pulse (see Figure 16). All devices recognize the address sent by the master and compare it to their internal fixed addresses. Only the slave device with a matching address generates an acknowledge (see Figure 17) by pulling the SDA line low during the entire high period of the ninth SCL cycle. Upon detecting this acknowledge, the master knows that communication link with a slave has been established.

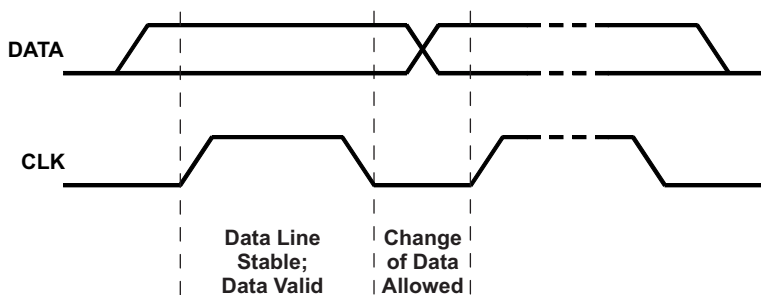

Figure 16. Bit Transfer on the Serial Interface

The master generates further SCL cycles to either transmit data to the slave (R/W bit 0) or receive data from the slave (R/W bit 1). In either case, the receiver needs to acknowledge the data sent by the transmitter. So an acknowledge signal can either be generated by the master or by the slave, depending on which one is the receiver. The 9-bit valid data sequences consisting of 8-bit data and 1-bit acknowledge can continue as long as necessary. To signal the end of the data transfer, the master generates a stop condition by pulling the SDA line from low to high while the SCL line is high (see Figure 15). This releases the bus and stops the communication link with the addressed slave. All I²C compatible devices must recognize the stop condition. Upon the receipt of a stop condition, all devices know that the bus is released, and wait for a start condition followed by a matching address. If a transaction is terminated prematurely, the master needs to send a STOP condition to prevent the slave I²C logic from remaining in an incorrect state. Attempting to read data from register addresses not listed in this section will result in 0xFFh being read out.

Programming (continued)

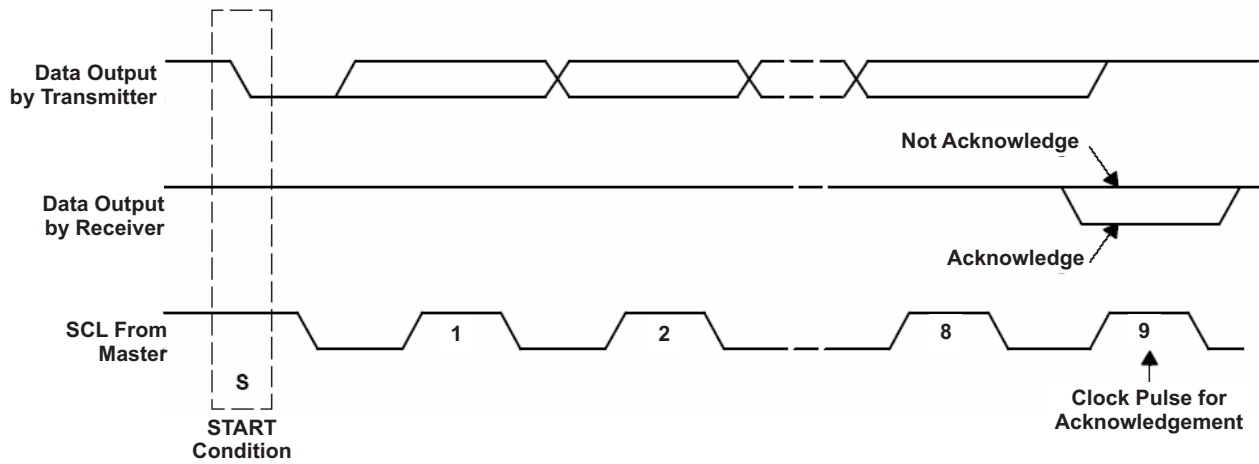

Figure 17. Acknowledge on the I²C Bus

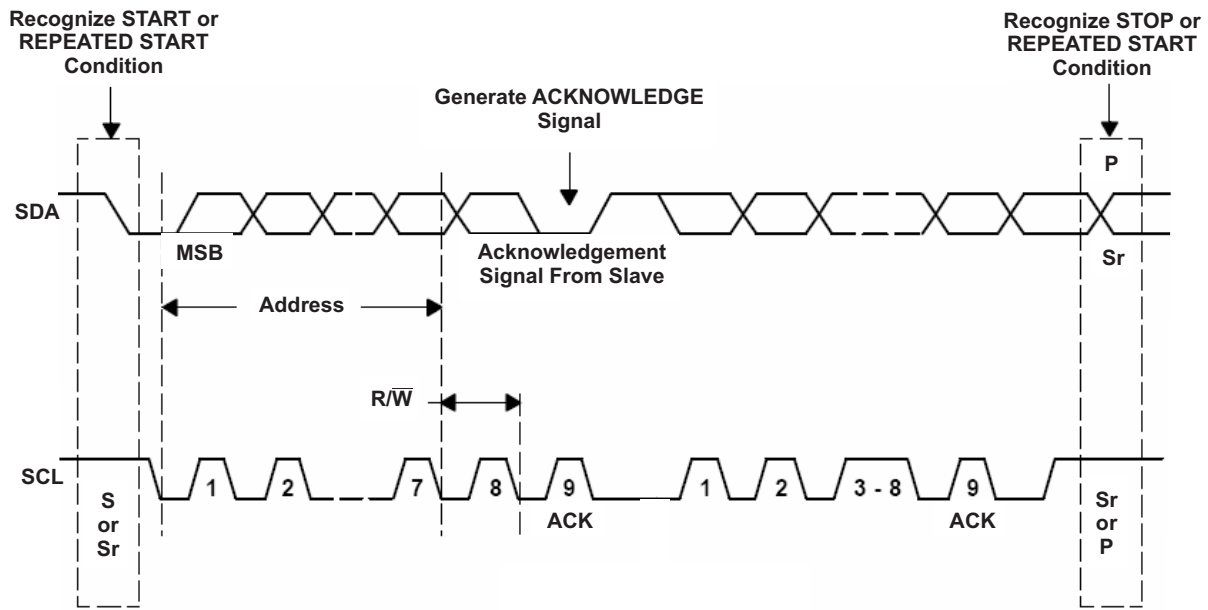

Figure 18. Bus Protocol

9.6 Register Maps

9.6.1 Status/Control Register (READ/WRITE)

Memory location: 00, Reset state: 00xx 0xxx

Figure 19. Status/Control Register

B7(MSB)	B6	B5	B4	B3	B2	B1	B0(LSB)
0	0	X	X	0	X	X	X
R/W	R/W	R	R	R/W	R	R	R

LEGEND: R/W = Read/Write; R = Read only; -n = value after reset

Table 2. Status/Control Register Field Descriptions

BIT	FIELD ⁽¹⁾ ⁽²⁾	TYPE	DESCRIPTION
B7(MSB)	TMR_RST	R/W	Write: TMR_RST function, write 1 to reset the watchdog timer (auto clear) Read: Always 0 (bq24260/1/1M only)
B6	EN_BOOST	R/W	0-Charger Mode 1-Boost Mode (default 0)
B5	STAT_1	R	00-Ready
B4	STAT_0	R	01-Charge in progress 10-Charge done 11-Fault
B3	EN_SHIPMODE	R/W	0-Normal Operation 1-Ship Mode Enabled (default 0)
B2	FAULT_2	R	000-Normal
B1	FAULT_1	R	001-VIN > VOVP or Boost Mode OVP
B0(LSB)	FAULT_0	R	010- Low Supply connected (VIN<VUVLO or VIN<VSLP) or Boost Mode Overcurrent 011- Thermal Shutdown 100-Battery Temperature Fault 101- Timer Fault (watchdog or safety timer) 110-Battery OVP 111-No Battery connected

- (1) STAT_x bits show current status. These bits change based on the current condition. When a status change occurs, a single 128- μ s pulse on the STAT and INT outputs occur and the STATx and FAULT_x bits of the status registers are updated in the I²C. Once the fault is removed, the STATx bits are updated to show the current status.
- (2) FAULT_x bits show faults. If a fault occurs, these bits announce the fault and do not clear until read. If more than one fault occurs only the highest priority fault is shown, ranked from 1 to 8 in the order shown in the table. When a fault occurs, a single 128- μ s pulse on the STAT and INT outputs occur and the STATx and FAULT_x bits of the status registers are updated in the I²C. The FAULT_x bits are not cleared until they are read in the I²C and the fault condition no longer exists.

EN_BOOST Bit (Operation Mode)

The EN_BOOST bit selects the operation mode for the bq24260/1/1M/2. Write a 1 to enable boost mode and regulate IN to 5V to supply OTG peripherals. See [Boost Mode Operation](#) for more details.

EN_SHIPMODE Bit

Writing the EN_SHIPMODE bit to a 1 latches off the IC, battery FET and BGATE until a high to low transition on UVLO occurs. This means that if EN_SHIPMODE is written to a 1 while the input is connected, it must first be removed and then replaced before the battery FET turns on. This allows the end product with no load on the battery and the end user will enable the device by plugging it into the adapter. The EN_SHIPMODE bit can be cleared using the I²C interface as well.

9.6.2 Control Register (READ/WRITE)

Memory location: 01, Reset state: 1xxx 1100 (bq24260/2), 1xxx 1110 (bq24261/1M)

Figure 20. bq24260/2 Control Register

B7(MSB)	B6	B5	B4	B3	B2	B1	B0(LSB)
1	X	X	X	1	1	0	.0
W	R/W	R/W	R/W	R/W	R/W	R/W	R/W

LEGEND: R/W = Read/Write; R = Read only; -n = value after reset

Figure 21. bq24261/1M Control Register

B7(MSB)	B6	B5	B4	B3	B2	B1	B0(LSB)
1	X	X	X	1	1	1	0
W	R/W	R/W	R/W	R/W	R/W	R/W	R/W

LEGEND: R/W = Read/Write; R = Read only; -n = value after reset

Table 3. Control Register Field Descriptions

BIT	FIELD	TYPE	DESCRIPTION
B7(MSB)	RESET	W	Write: 1-Reset all registers to default values 0-No effect Read: always get 1
B6	IN_LIMIT_2	R/W	000-USB2.0 host with 100-mA current limit
B5	IN_LIMIT_1	R/W	001-USB3.0 host with 150-mA current limit
B4	IN_LIMIT_0	R/W	010 – USB2.0 host with 500-mA current limit 011 – USB3.0 host/charger with 900-mA current limit 100 – Charger with 1500-mA current limit 101—Charger with 1950-mA current limit 110 – Charger with 2500-mA current limit 111- Charger with 2000-mA current limit (default 000 ⁽¹⁾)
B3	EN_STAT	R/W	0-Disable STAT function (STAT only shows faults) 1-Enable STAT function (default 1)
B2	TE	R/W	0-Disable charge current termination 1-Enable charge current termination (default 1)
B1	$\overline{\text{CE}}$	R/W	0-Charger enabled 1-Charger is disabled (default 0-bq24260 / 2, 1-bq24261/1M)
B0(LSB)	HZ_MODE	R/W	0-Not high impedance mode 1-High impedance mode (default 0)

(1) When in DEFAULT mode, PSEL (bq24261/1M/2) determines the default input current limit.

RESET Bit

The RESET bit in the control register (0x01h) is used to reset all the charge parameters. Write 1 to RESET bit to reset all the registers to default values and place the bq24260/1/1M/2 into DEFAULT mode and turn off the watchdog timer. The RESET bit is automatically cleared to zero once the bq24260/1/1M/2 enters DEFAULT mode.

$\overline{\text{CE}}$ Bit (Charge Enable)

The $\overline{\text{CE}}$ bit is used to disable or enable the charge process. A low logic level (0) on this bit enables the charge and a high logic level (1) disables the charge. When charge is disabled, the SYS output regulates to $V_{\text{SYS(REG)}}$ and battery is disconnected from the SYS. Supplement mode is available if the system load demands cannot be met by the supply.

HZ_MODE Bit (High Impedance Mode Enable)

bq24260, bq24261, bq24261M, bq24262

SLUSBU4E – DECEMBER 2013 – REVISED DECEMBER 2015

www.ti.com

The HZ_MODE bit is used to disable or enable the high impedance mode. A low logic level (0) on this bit enables the IC and a high logic level (1) puts the IC in a low quiescent current state called high impedance mode. When in high impedance mode, the converter is off and the battery FET and BGATE are on. The load on SYS is supplied by the battery. BGATE is low (external FET turned on) while in high impedance mode.

9.6.3 Control/Battery Voltage Register (READ/WRITE)

Memory location: 02, Reset state: 0001 0100 (BQ24260/1/1M), 1000 1100 (bq24262)

Figure 22. bq24260/1/1M Control/Battery Voltage Register

B7(MSB)	B6	B5	B4	B3	B2	B1	B0(LSB)
1	0	0	0	1	1	0	0
R/W	R/W	R/W	R/W	R/W	R/W	R/W	R/W

LEGEND: R/W = Read/Write; R = Read only; -n = value after reset

Figure 23. bq24262 Control/Battery Voltage Register

B7(MSB)	B6	B5	B4	B3	B2	B1	B0(LSB)
0	0	0	1	0	1	0	0
R/W	R/W	R/W	R/W	R/W	R/W	R/W	R/W

LEGEND: R/W = Read/Write; R = Read only; -n = value after reset

Table 4. Control/Battery Voltage Register Field Descriptions

BIT	FIELD	TYPE	DESCRIPTION
B7(MSB)	V _{BREG5}	R/W	Battery Regulation Voltage: 640 mV (default 0)
B6	V _{BREG4}	R/W	Battery Regulation Voltage: 320 mV (default 0)
B5	V _{BREG3}	R/W	Battery Regulation Voltage: 160 mV (default 0)
B4	V _{BREG2}	R/W	Battery Regulation Voltage: 80 mV (default 1)
B3	V _{BREG1}	R/W	Battery Regulation Voltage: 40 mV (default 0)
B2	V _{BREG0}	R/W	Battery Regulation Voltage: 20 mV (default 1)
B1	MOD_FREQ1	R/W	Modify Switching Frequency Target – 00 – No Change to Nominal Frequency Target 01 – +10% Change to Nominal Frequency 10 – -10% Change to Nominal Frequency 11 – NA (default 00)
B0(LSB)	MOD_FREQ0	R/W	

V_{BREG} Bits (Battery Regulation Threshold setting)

Use V_{BREG} bits to set the battery regulation threshold. The V_{BATREG} is calculated using the following equation:

$$V_{BATREG} = 3.5 \text{ V} + V_{BREG}CODE \times 20 \text{ mV}$$

The charge voltage range is 3.5 V to 4.44 V with the offset of 3.5 V and step of 20 mV. The default setting is 3.6 V for the bq24260 and bq24261 and bq24261M. The default setting is 4.2 V for the bq24262. If a value greater than 4.44 V is written, the setting goes to 4.44 V. It is recommended to set V_{BATREG} above V_{MINSYS}.

MOD_FREQx Bits (Frequency Modification)

The MOD_FREQx bits are used to change the switching frequency by ±10%. This is used for applications where the 1.5MHz switching frequency noise interferes with other device operation. The frequency may be modified by ±10% of the nominal frequency.

bq24260, bq24261, bq24261M, bq24262

SLUSBU4E – DECEMBER 2013 – REVISED DECEMBER 2015

www.ti.com

9.6.4 Vender/Part/Revision Register (READ only)

Memory location: 03, Reset state: 0100 0110

Figure 24. Vender/Part/Revision Register

B7(MSB)	B6	B5	B4	B3	B2	B1	B0(LSB)
0	1	0	0	0	1	1	0
R	R	R	R	R	R	R	R

LEGEND: R/W = Read/Write; R = Read only; -n = value after reset

Table 5. Vender/Part/Revision Register Field Descriptions

BIT	FIELD	TYPE	DESCRIPTION
B7(MSB)	Vendor2	R	Vender Code: bit 2 (default 0)
B6	Vendor1	R	Vender Code: bit 1 (default 1)
B5	Vendor0	R	Vender Code: bit 0 (default 0)
B4	PN1	R	For I ² C Address 6Bh: 00 – bq24260/1/1M/2
B3	PN0	R	
B2	NA	R	NA
B1	NA	R	NA
B0(LSB)	NA	R	NA

9.6.5 Battery Termination/Fast Charge Current Register (READ/WRITE)

Memory location: 04, Reset state: 0010 1010

Figure 25. Battery Termination/Fast Charge Current Register

B7(MSB)	B6	B5	B4	B3	B2	B1	B0(LSB)
0	0	1	0	1	0	1	0
R/W	R/W	R/W	R/W	R/W	R/W	R/W	R/W

LEGEND: R/W = Read/Write; R = Read only; -n = value after reset

Table 6. Battery Termination/Fast Charge Current Register Field Descriptions

BIT	FIELD	TYPE	DESCRIPTION
B7(MSB)	I _{CHRG4}	R/W	Charge current 1600 mA – (default 0)
B6	I _{CHRG3}	R/W	Charge current: 800 mA — (default 0)
B5	I _{CHRG2}	R/W	Charge current: 400 mA —(default 1)
B4	I _{CHRG1}	R/W	Charge current: 200 mA — (default 0)
B3	I _{CHRG0}	R/W	Charge current: 100 mA (default 1)
B2	I _{TERM2}	R/W	Termination current sense: 200 mA (default 0)
B1	I _{TERM1}	R/W	Termination current sense voltage: 100 mA (default 1)
B0(LSB)	I _{TERM0}	R/W	Termination current sense voltage: 50 mA (default 0)

I_{CHRG} Bits (Charge Current Regulation Threshold setting)

Use I_{CHRG} bits to set the charge current regulation threshold. The charge current is programmable from 500 mA to 3 A in 100 mA steps. The default is 1 A. The I_{CHARGE} is calculated using the following equation:

$$I_{\text{CHARGE}} = 500 \text{ mA} + I_{\text{CHRG}} \text{CODE} \times 100 \text{ mA}$$

Any setting programmed above 3 A selects the 3-A setting.

I_{TERM} Bits (Charge Current Termination Threshold setting)

Use I_{TERM} bits to set the charge current termination threshold. The termination threshold is programmable from 50 mA to 300 mA in 50-mA steps. The default is 150 mA. The I_{TERM} is calculated using the following equation:

$$I_{\text{TERM}} = 50 \text{ mA} + I_{\text{TERM}} \text{CODE} \times 50 \text{ mA}$$

Any setting programmed above 300 mA selects the 300-mA setting.

bq24260, bq24261, bq24261M, bq24262

SLUSBU4E – DECEMBER 2013 – REVISED DECEMBER 2015

www.ti.com

9.6.6 V_{IN-DPM} Voltage/ MINSYS Status Register

Memory location: 05, Reset state: xx00 x000

Figure 26. V_{IN-DPM} Voltage/ MINSYS Status Register

B7(MSB)	B6	B5	B4	B3	B2	B1	B0(LSB)
X	X	0	0	X	0	0	0
R	R	R/W	R/W	R	R/W	R/W	R/W

LEGEND: R/W = Read/Write; R = Read only; -n = value after reset

Table 7. V_{IN-DPM} Voltage/ MINSYS Status Register Field Descriptions

BIT	FIELD	TYPE	DESCRIPTION
B7(MSB)	MINSYS_STATUS	R	0 – Minimum System Voltage mode is not active 1 – Minimum System Voltage mode is active (low battery)
B6	VINDPM_STATUS	R	0 – VIN-DPM mode is not active 1 – VIN-DPM mode is active
B5	LOW_CHG	R/W	0 – Normal charge current set by 04h 1 – Low charge current setting 300 mA (default 0)
B4	FORCE_D+D-	R/W	0 - Detection complete 1 - Force D+/D- detection (bq24260 only)
B3	CD_STATUS	R	0 – CD low, IC enabled 1 – CD high, IC disabled
B2	V _{INDPM2}	R/W	Input V _{IN-DPM} voltage: V _{DPMOFF} + 8% (default 0)
B1	V _{INDPM1}	R/W	Input V _{IN-DPM} voltage: V _{DPMOFF} + 4% (default 0)
B0(LSB)	V _{INDPM0}	R/W	Input V _{IN-DPM} voltage: V _{DPMOFF} + 2% (default 0)

- V_{IN-DPM} voltage offset is programmable using the VINDPM_OFF bit (bit 0 of register 0x06) and default V_{IN-DPM} threshold is 4.2 V.

LOW_CHG Bit (Low Charge Mode Enable)

The LOW_CHG bit is used to reduce the charge current to a minimum current. This feature is used by systems where battery NTC is monitored by the host and requires a reduced charge current setting or by systems that need a “preconditioning” current for low battery voltages. Write a 1 to this bit to charge at 300 mA. Write a 0 to this bit to charge at the programmed charge current.

V_{INDPM} Bits (V_{INDPM} Threshold setting)

Use V_{INDPM} bits to set the V_{INDPM} regulation threshold. The V_{INDPM} threshold is calculated using the following equation:

$$V_{INDPM} = V_{INDPM_OFF} + V_{INDPM_CODE} \times 2\% \times V_{INDPM_OFF}$$

9.6.7 Safety Timer/ NTC Monitor Register (READ/WRITE)

Memory location: 06, Reset state: 1001 1xx0

Figure 27. Safety Timer/ NTC Monitor Register

B7(MSB)	B6	B5	B4	B3	B2	B1	B0(LSB)
1	0	0	1	1	X	X	0
R/W	R/W	R/W	R/W	R/W	R	R	R/W

LEGEND: R/W = Read/Write; R = Read only; -n = value after reset

Table 8. Safety Timer/ NTC Monitor Register Field Descriptions

BIT	FIELD	TYPE	DESCRIPTION
B7(MSB)	2XTMR_EN	R/W	0 – Timer not slowed at any time 1 – Timer slowed by 2x when in thermal regulation, V_{IN_DPM} or input current limit (default 1)
B6	TMR_1	R/W	Safety Timer Time Limit – 00 – 1.25 minute fast charge 01 – 6 hour fast charge 10 – 9 hour fast charge 11 – Disable safety timers (default 00) (bq24260/1/1M only)
B5	TMR_2	R/W	
B4	BOOST_ILIM	R/W	0 – 500 mA 1 – 1 A (Default 1)
B3	TS_EN	R/W	0 – TS function disabled 1 – TS function enabled (default 1)
B2	TS_FAULT1	R	TS Fault Mode: 00 – Normal, No TS fault 01 – TS temp < T_{COLD} or TS temp > T_{HOT} (Charging suspended) 10 – $T_{COOL} > TS\ temp > T_{COLD}$ (Charge current reduced by half) 11 – $T_{WARM} < TS\ temp < T_{HOT}$ (Charge voltage reduced by 100mV)
B1	TS_FAULT0	R	
B0(LSB)	VINDPM_OFF	R/W	0 – 4.2 V 1 – 10.1 V (Default 0)

BOOST_ILIM Bit (Boost current limit setting)

The BOOST_ILIM bit programs the cycle by cycle current limit threshold for boost operation. The 1-A setting sets the low side cycle by cycle current limit to 4 A (typical). This ensures that at least 1 A can be supplied from the boost converter over the entire battery range. The 500-mA setting sets the current limit to 2 A (typ) to ensure at least 500 mA available from the boost converter. See [Output Overcurrent Protection](#) for more details.

VINDPM_OFF Bit (V_{INDPM} offset setting)

The VINDPM_OFF bit programs the offset for the VINDPM function. The 4.2-V setting is intended to work with a standard 5-V output adapter. The 10.1-V setting supports 12-V adapters and the 12-V output for the new USB Power Delivery specification (USB PD).

10 Application and Implementation

NOTE

Information in the following applications sections is not part of the TI component specification, and TI does not warrant its accuracy or completeness. TI's customers are responsible for determining suitability of components for their purposes. Customers should validate and test their design implementation to confirm system functionality.

10.1 Application Information

The bq24260EVM-079 evaluation module (EVM) is a complete charger module for evaluating the bq24260. The application curves were taken using the bq24260EVM-079. See [Related Documentation](#) for details.

The EVM supports both typical application circuits shown below through board options. [Figure 28](#) shows the bq24261 using PSEL for the input current limit selection. [Figure 28](#) shows the bq24260 using D+/D- for the input current limit selection. [Figure 28](#) also shows the addition of an external battery FET. This external FET can be used with the bq24260/1/1M/2 to provide lower loss discharge path from the battery, and is controlled by the BGATE pin.

10.2 Typical Application

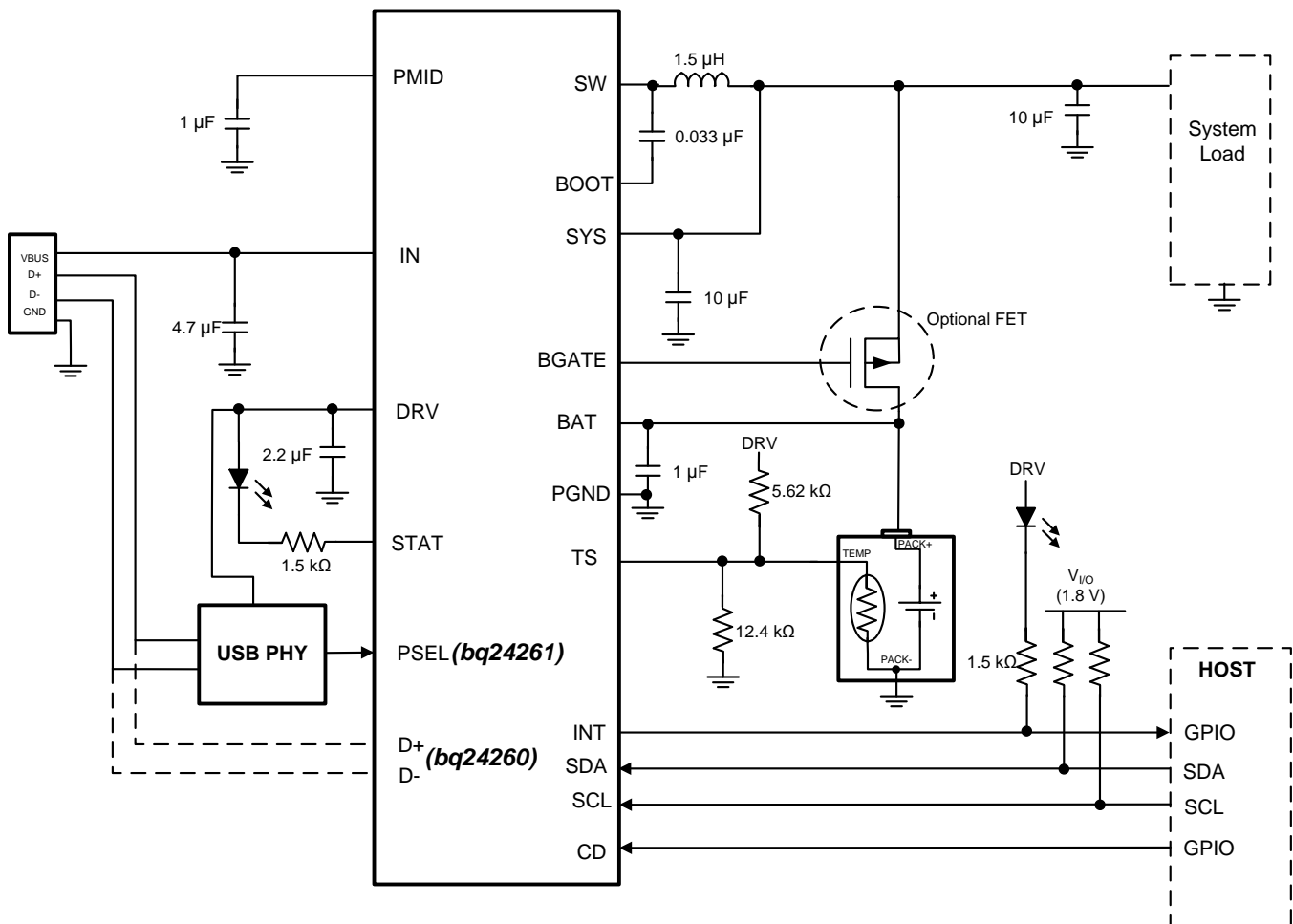

Figure 28. bq24260/1 Typical Application Circuit

Typical Application (continued)

10.2.1 Design Requirements

For this example, use the parameters listed in [Table 9](#).

Table 9. Design Requirements

DESIGN PARAMETER	EXAMPLE VALUE
Input Voltage Range	4.75 V to 5.25 V nominal, withstand 28 V
Input Current Limit	2500 mA
Input DPM Threshold	4.25 V
Fast Charge Current	3000 mA
Battery Charge Voltage	4.2 V
Termination Current	50 mA

10.2.2 Detailed Design Procedure

Following the guidance in the next section, the capacitors on IN, PMID, SYS, BAT and BOOT are the minimum recommended values of 4.7 μF , 1 μF , 10 μF , 1 μF , and 0.033 μF , respectively. It is assumed that at least 10 μF of additional capacitance is on the SYS rail. To minimize footprint, a 1.5- μH inductor with at least 3.5-A saturation current is selected. The optional FET, with gate connected at BGATE, only turns on in high-impedance mode (for example, no input power/battery only) to reduce the losses across the internal battery FET of the IC. See the bq24261EVM for exact part numbers. Pullup resistors for STAT and INT of 1.5 k Ω were selected per the current requirements of the LED. The values for the resistor divider on TS were found using [Equation 1](#) and [Equation 2](#), where RHOT is the resistance of the NTC thermistor at the hot temperature, RCOLD is the resistance of the thermistor at cold temperature, VDRV = 5 V, VHOT = 0.3 \times VDRV and VCOLD = 0.6 \times VDRV.

Many parameters configurable by the I²C registers can be changed by using the EVM software.

10.2.2.1 Output Inductor and Capacitor Selection Guidelines

When selecting an inductor, several attributes must be examined to find the right part for the application. First, the inductance value should be selected. The bq2426x is designed to work with 1.5- μH to 2.2- μH inductors. The chosen value will have an effect on efficiency and package size. Due to the smaller current ripple, some efficiency gain is reached using the 2.2- μH inductor. However, due to the physical size of the inductor, this option may not be viable. The 1.5- μH inductor provides a good tradeoff between size and efficiency.

Once the inductance has been selected, the peak current must be calculated in order to choose the current rating of the inductor. Use [Equation 5](#) to calculate the peak current.

$$I_{\text{PEAK}} = I_{\text{LOAD(MAX)}} \times \left(1 + \frac{\% \text{RIPPLE}}{2} \right) \quad (5)$$

The inductor selected must have a saturation current rating greater than or equal to the calculated I_{PEAK} . Due to the high currents possible with the bq24260/1/1M/2, a thermal analysis must also be done for the inductor. Many inductors have 40°C temperature rise rating. This is the DC current that will cause a 40°C temperature rise above the ambient temperature in the inductor. For this analysis, the typical load current may be used adjusted for the duty cycle of the load transients. For example, if the application requires a 1.5-A DC load with peaks at 2.5 A 20% of the time, a $\Delta 40^\circ\text{C}$ temperature rise current must be greater than 1.7 A:

$$I_{\text{TEMPRISE}} = I_{\text{LOAD}} + D \times (I_{\text{PEAK}} - I_{\text{LOAD}}) = 1.5 \text{ A} + 0.2 \times (2.5 \text{ A} - 1.5 \text{ A}) = 1.7 \text{ A} \quad (6)$$

The internal loop compensation of the bq24260/1/1M/2 is designed to be stable with 10 μF to 150 μF of local capacitance but requires at least 20 μF total capacitance on the SYS rail (10 μF local + \geq 10 μF distributed). The capacitance on the SYS rail can be higher than 150 μF if distributed amongst the rail. To reduce the output voltage ripple, a ceramic capacitor with the capacitance between 10 μF and 47 μF is recommended for local bypass to SYS. If greater than 100 μF effective capacitance is on the SYS rail, place at least 10- μF bypass on the BAT terminal. Pay special attention to the DC bias characteristics of ceramic capacitors. For small case sizes, the capacitance can be derated as high as 70% at workable voltages. All capacitances specified in this data sheet are effective capacitance, not capacitor value.

10.2.3 Application Curves

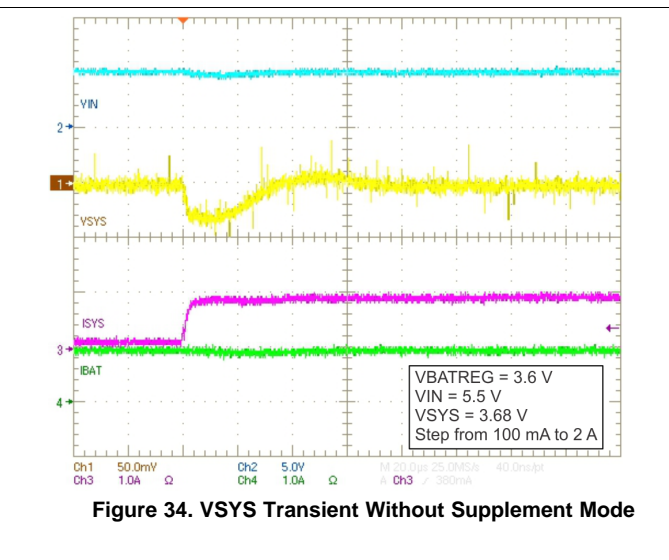
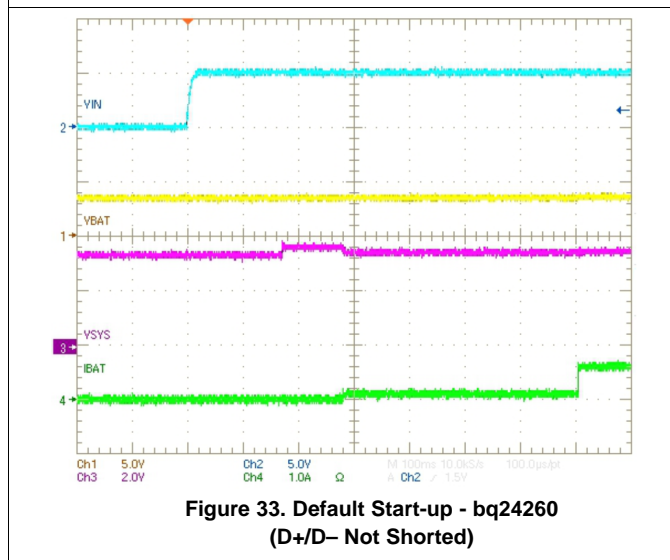
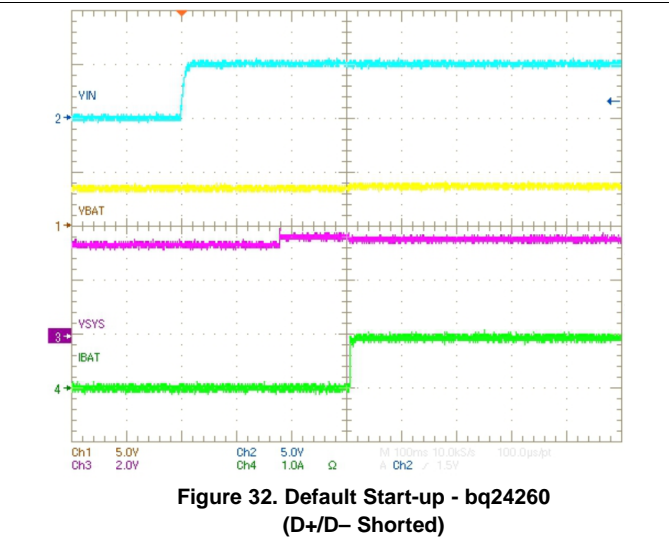
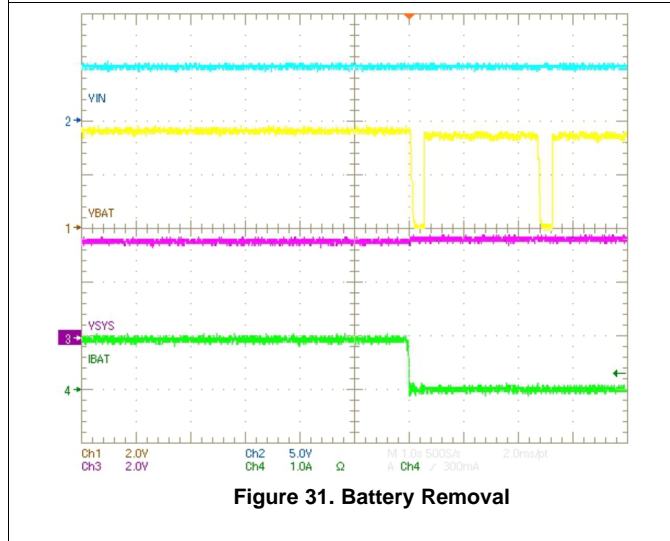
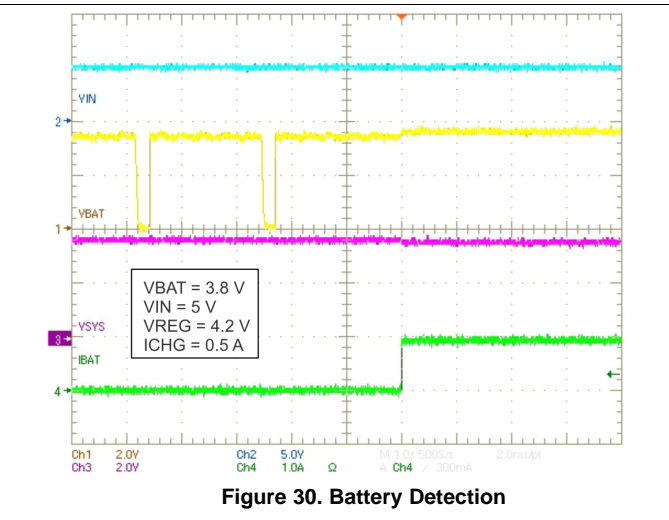
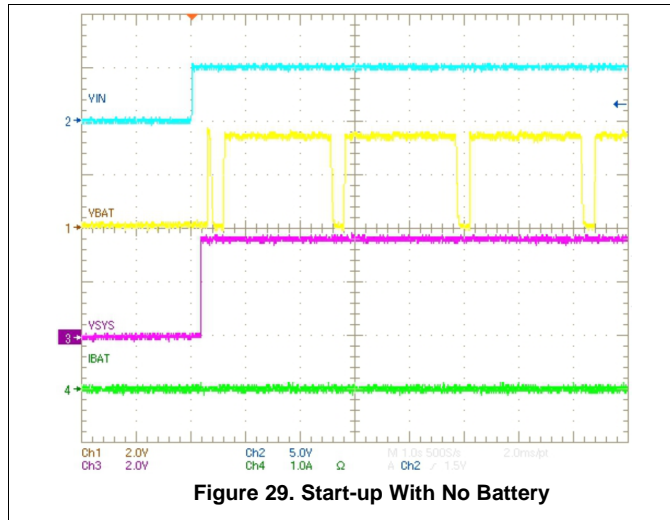

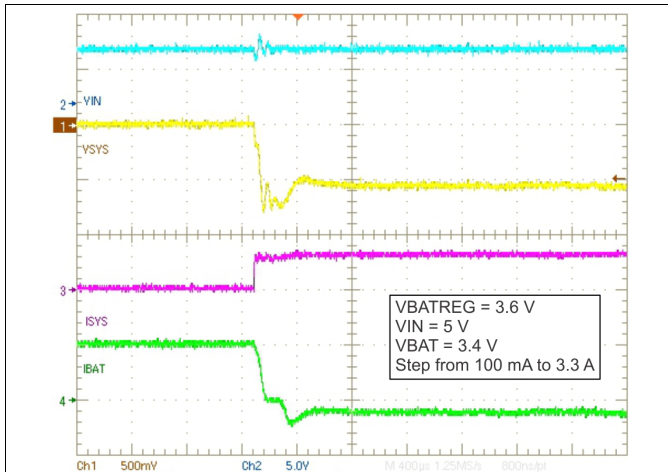

Figure 35. VSYS Transient With Supplement Mode

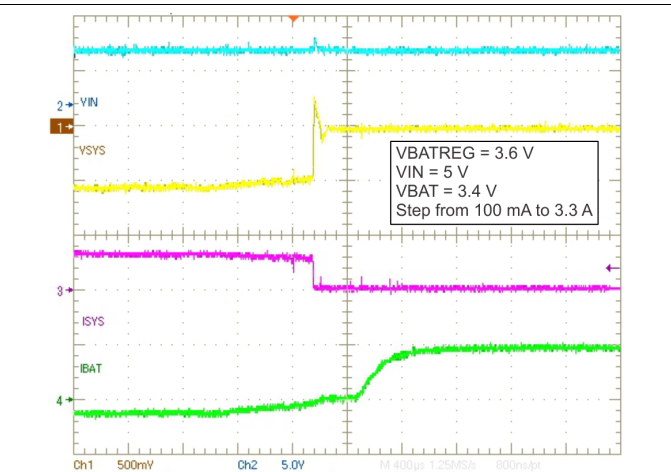

Figure 36. VSYS Transient With Supplement Mode

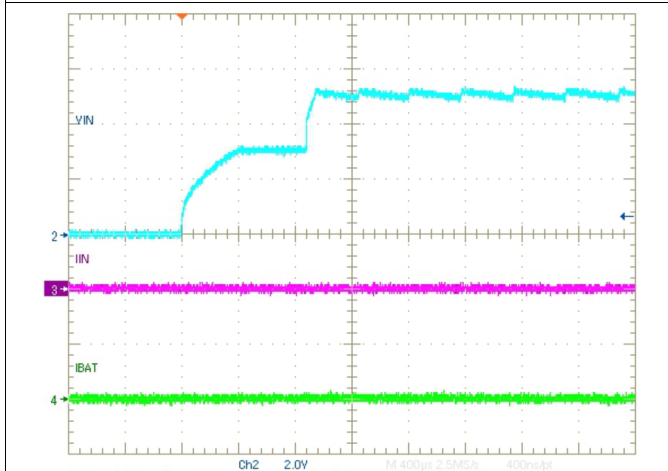

Figure 37. Boost Start-up No Load

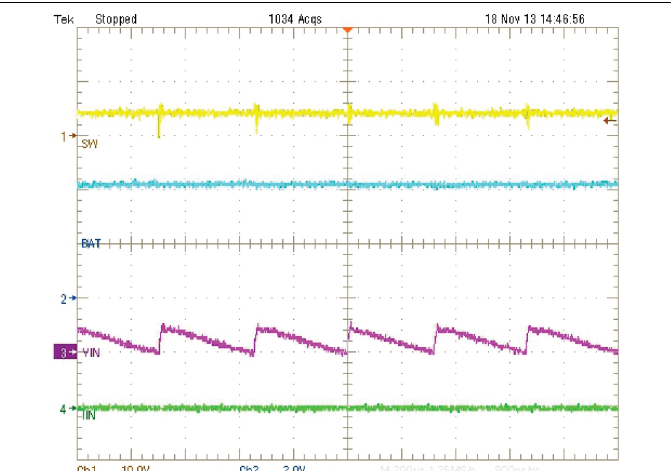

Figure 38. Boost Burst Mode During Light Load

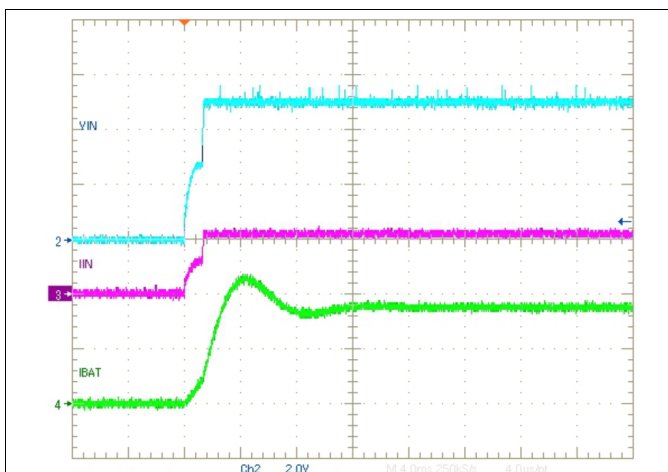

Figure 39. Boost Start-up 1-A Load

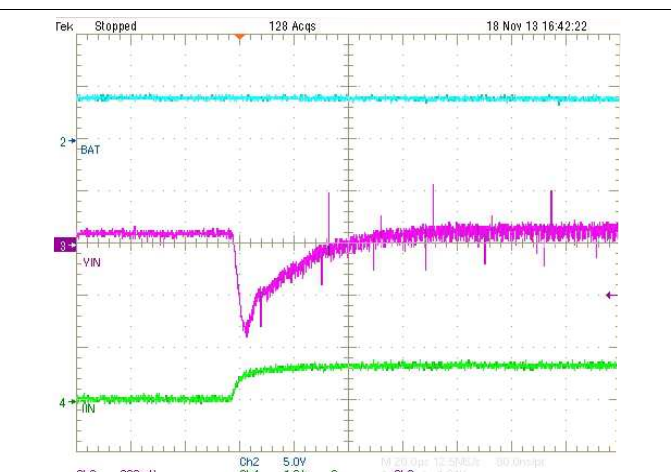
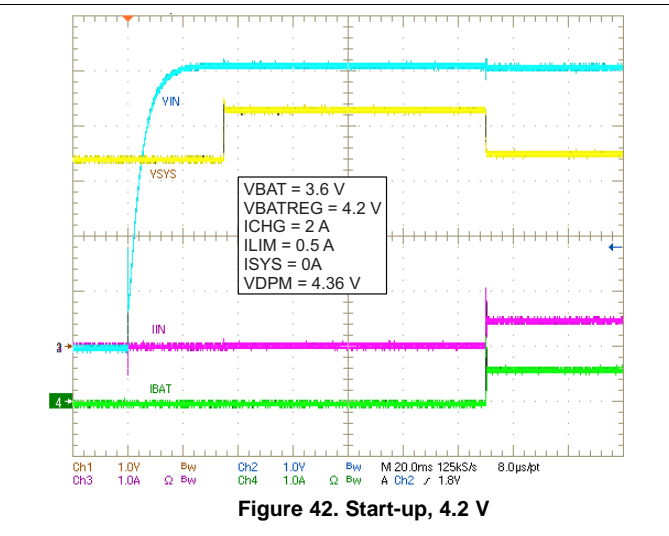
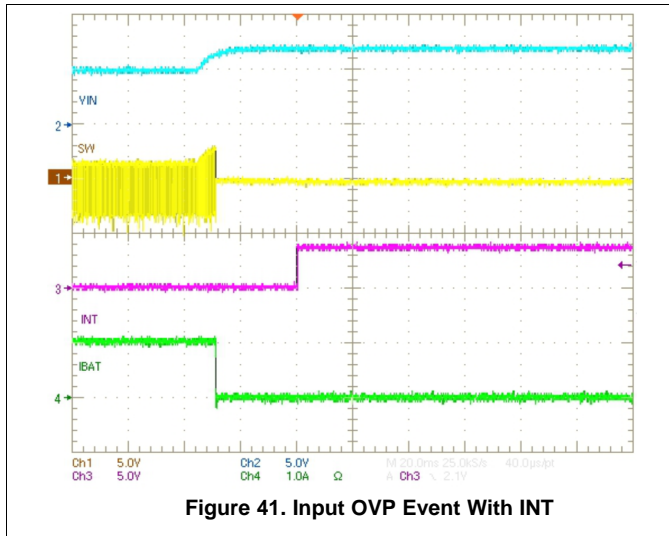

Figure 40. Boost Transient Response



11 Power Supply Recommendations

11.1 Requirements for SYS Output

In order to provide an output voltage on SYS, the bq2426x requires either a power supply between 4.2 V and 6 V input on all versions, 4.2 V and 6.5 V for IN input on bq24262, 4.2 V and 10.5 V on bq24260, and 4.2 and 14 V on bq24261/M with at least 100 mA current rating connected to IN; or, a single-cell Li-Ion battery with voltage > VBATUVLO connected to BAT. The source current rating must be at least 2.5 A for the buck converter of the charger to provide maximum output power to SYS.

11.2 Requirements for Charging

In order for charging to occur the source voltage measured at the IN terminals of the IC, factoring in cable/trace losses from the source, must be greater than the VINDPM threshold, but less than the maximum values shown above. The current rating of the source must be higher than the buck converter needs to provide the load on SYS. For charging at a desired charge current of I_{CHRG} , $V_{IN} \times I_{IN} \times \eta > V_{SYS} \times (I_{SYS} + I_{CHRG})$ where η is the efficiency estimate from [Figure 2](#) or [Figure 3](#) and $V_{SYS} = V_{BAT}$ when VBAT charges above VMINSYS. The charger limits I_{IN} to the current limit setting of that input. With $I_{SYS} = 0$ A, the charger consumes maximum power at the end of CC mode, when the voltage at the BAT terminal is near VBATREG but ICHRG has not started to taper off toward ITERM.

12 Layout

12.1 Layout Guidelines

The following provides some guidelines:

- Place 1- μ F input capacitor as close to PMID terminal and PGND terminal as possible to make high-frequency current loop area as small as possible.
- Connect the GND of the PMID and IN capacitors as close as possible.
- Place 4.7- μ F input capacitor as close to IN terminal and PGND terminal as possible to make high-frequency current loop area as small as possible.
- The local bypass capacitor from SYS to GND should be connected between the SYS terminal and PGND of the IC. The intent is to minimize the current path loop area from the SW terminal through the LC filter and back to the PGND terminal.
- Place all decoupling capacitors close to their respective IC terminal and as close as to PGND as possible. Do not place components such that routing interrupts power stage currents. All small control signals should be routed away from the high current paths.
- The PCB should have a ground plane (return) connected directly to the return of all components through vias. Two vias per capacitor for power-stage capacitors and one via per capacitor for small-signal components. TI also recommends putting vias inside the PGND pads for the IC, if possible. A star ground design approach is typically used to keep circuit block currents isolated (high-power/low-power small-signal) which reduces noise-coupling and ground-bounce issues. A single ground plane for this design gives good results.
- The high-current charge paths into IN, BAT, SYS and from the SW terminals must be sized appropriately for the maximum charge current in order to avoid voltage drops in these traces. The PGND terminals should be connected to the ground plane to return current through the internal low-side FET.
- For high-current applications, the balls for the power paths should be connected to as much copper in the board as possible. This allows better thermal performance as the board pulls heat away from the IC.

12.2 Layout Example

It is important to pay special attention to the PCB layout. [Figure 43](#) provides a sample layout for the high current paths of the bq2426xYFF. [Figure 44](#) provides a sample layout for the high current paths of the bq2426xRGE.

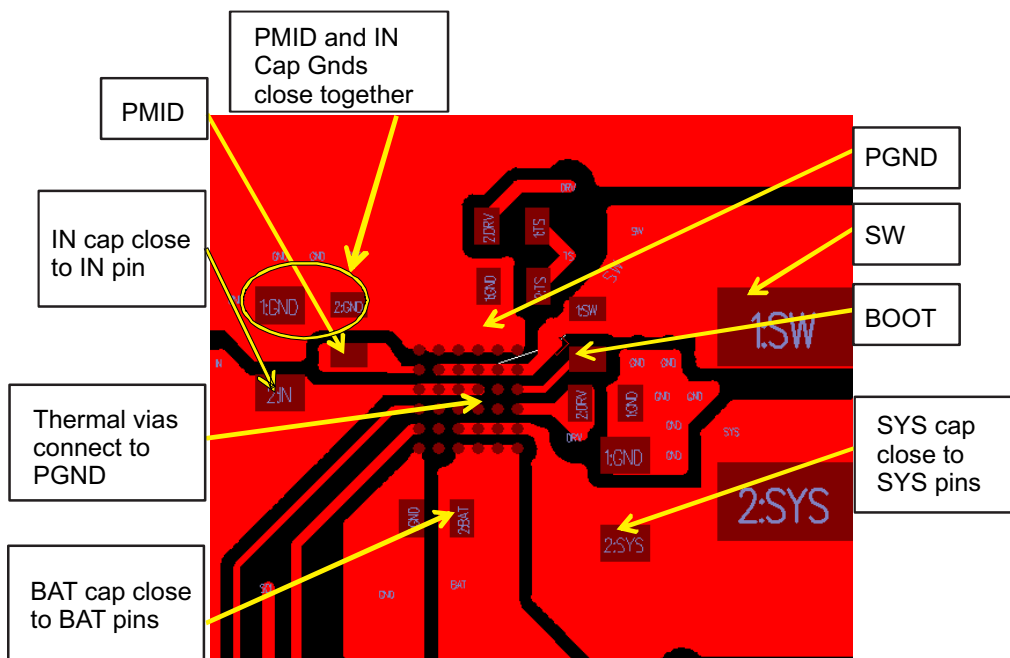

Figure 43. Recommended bq2426x PCB Layout for WCSP Package

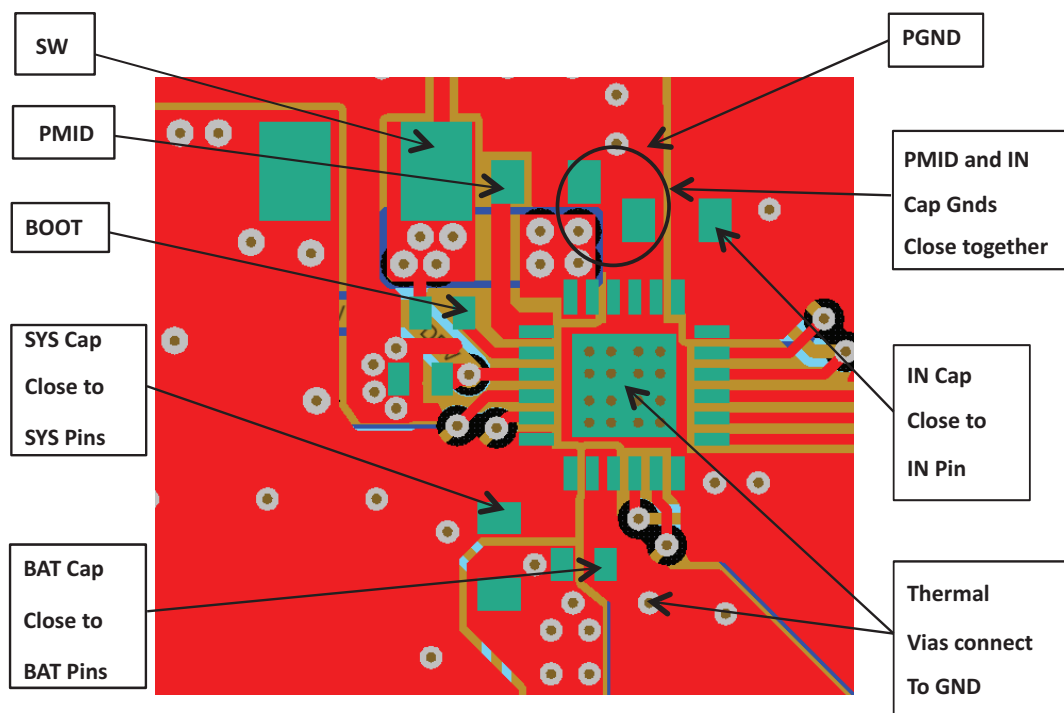

Figure 44. Recommended bq2426x PCB Layout for QFN Package

13 Device and Documentation Support

13.1 Documentation Support

13.1.1 Related Documentation

User's Guide for WCSP Packaged bq24260, bq24261 and bq24262A 3-A Battery Charger Evaluation Module, [SLUUAB0](#).

User's Guide for QFN Packaged bq24260, bq24261, and bq24262 3-A Battery Charger Evaluation Module, [SLUUA8](#).

3A, Host-Controlled Single-Input, Single Cell Switchmode Li-Ion Battery Charger Evaluation Module, <http://www.ti.com/tool/bq24261evm-611>.

Host-Controlled Single-Input, Single Cell Switchmode Li-Ion Battery Charger Evaluation Module, <http://www.ti.com/tool/bq24261evm-079>.

EVM Software, [SLUC519](#)

13.2 Related Links

The table below lists quick access links. Categories include technical documents, support and community resources, tools and software, and quick access to sample or buy.

Table 10. Related Links

PARTS	PRODUCT FOLDER	SAMPLE & BUY	TECHNICAL DOCUMENTS	TOOLS & SOFTWARE	SUPPORT & COMMUNITY
bq24260	Click here	Click here	Click here	Click here	Click here
bq24261	Click here	Click here	Click here	Click here	Click here
bq24262	Click here	Click here	Click here	Click here	Click here
bq24261M	Click here	Click here	Click here	Click here	Click here

13.3 Community Resources

The following links connect to TI community resources. Linked contents are provided "AS IS" by the respective contributors. They do not constitute TI specifications and do not necessarily reflect TI's views; see TI's [Terms of Use](#).

TI E2E™ Online Community *TI's Engineer-to-Engineer (E2E) Community*. Created to foster collaboration among engineers. At e2e.ti.com, you can ask questions, share knowledge, explore ideas and help solve problems with fellow engineers.

Design Support *TI's Design Support* Quickly find helpful E2E forums along with design support tools and contact information for technical support.

13.4 Trademarks

E2E is a trademark of Texas Instruments.
All other trademarks are the property of their respective owners.

13.5 Electrostatic Discharge Caution



These devices have limited built-in ESD protection. The leads should be shorted together or the device placed in conductive foam during storage or handling to prevent electrostatic damage to the MOS gates.

13.6 Glossary

[SLYZ022](#) — *TI Glossary*.

This glossary lists and explains terms, acronyms, and definitions.

bq24260, bq24261, bq24261M, bq24262

SLUSBU4E – DECEMBER 2013 – REVISED DECEMBER 2015

www.ti.com

14 Mechanical, Packaging, and Orderable Information

The following pages include mechanical, packaging, and orderable information. This information is the most current data available for the designated devices. This data is subject to change without notice and revision of this document. For browser-based versions of this data sheet, refer to the left-hand navigation.

PACKAGING INFORMATION

Orderable Device	Status (1)	Package Type	Package Drawing	Pins	Package Qty	Eco Plan (2)	Lead/Ball Finish (6)	MSL Peak Temp (3)	Op Temp (°C)	Device Marking (4/5)	Samples
BQ24260RGER	LIFEBUY	VQFN	RGE	24	3000	Green (RoHS & no Sb/Br)	CU NIPDAU	Level-2-260C-1 YEAR	-40 to 85	BQ 24260	
BQ24260RGET	LIFEBUY	VQFN	RGE	24	250	Green (RoHS & no Sb/Br)	CU NIPDAU	Level-2-260C-1 YEAR	-40 to 85	BQ 24260	
BQ24260YFFR	LIFEBUY	DSBGA	YFF	36	3000	Green (RoHS & no Sb/Br)	SNAGCU	Level-1-260C-UNLIM	-40 to 85	BQ24260	
BQ24260YFFT	NRND	DSBGA	YFF	36	250	Green (RoHS & no Sb/Br)	SNAGCU	Level-1-260C-UNLIM	-40 to 85	BQ24260	
BQ24261MRGER	LIFEBUY	VQFN	RGE	24	3000	Green (RoHS & no Sb/Br)	CU NIPDAU	Level-2-260C-1 YEAR	-40 to 85	BQ 24261M	
BQ24261MRGET	LIFEBUY	VQFN	RGE	24	250	Green (RoHS & no Sb/Br)	CU NIPDAU	Level-2-260C-1 YEAR	-40 to 85	BQ 24261M	
BQ24261MYFFR	NRND	DSBGA	YFF	36	3000	Green (RoHS & no Sb/Br)	SNAGCU	Level-1-260C-UNLIM	-40 to 85	BQ24261M	
BQ24261MYFFT	LIFEBUY	DSBGA	YFF	36	250	Green (RoHS & no Sb/Br)	SNAGCU	Level-1-260C-UNLIM	-40 to 85	BQ24261M	
BQ24261RGER	LIFEBUY	VQFN	RGE	24	3000	Green (RoHS & no Sb/Br)	CU NIPDAU	Level-2-260C-1 YEAR	-40 to 85	BQ 24261	
BQ24261RGET	LIFEBUY	VQFN	RGE	24	250	Green (RoHS & no Sb/Br)	CU NIPDAU	Level-2-260C-1 YEAR	-40 to 85	BQ 24261	
BQ24261YFFR	LIFEBUY	DSBGA	YFF	36	3000	Green (RoHS & no Sb/Br)	SNAGCU	Level-1-260C-UNLIM	-40 to 85	BQ24261	
BQ24261YFFT	LIFEBUY	DSBGA	YFF	36	250	Green (RoHS & no Sb/Br)	SNAGCU	Level-1-260C-UNLIM	-40 to 85	BQ24261	
BQ24262RGER	LIFEBUY	VQFN	RGE	24	3000	Green (RoHS & no Sb/Br)	CU NIPDAU	Level-2-260C-1 YEAR	-40 to 85	BQ 24262	
BQ24262RGET	LIFEBUY	VQFN	RGE	24	250	Green (RoHS & no Sb/Br)	CU NIPDAU	Level-2-260C-1 YEAR	-40 to 85	BQ 24262	
BQ24262YFFR	LIFEBUY	DSBGA	YFF	36	3000	Green (RoHS & no Sb/Br)	SNAGCU	Level-1-260C-UNLIM	-40 to 85	BQ24262	
BQ24262YFFT	LIFEBUY	DSBGA	YFF	36	250	Green (RoHS & no Sb/Br)	SNAGCU	Level-1-260C-UNLIM	-40 to 85	BQ24262	

(1) The marketing status values are defined as follows:
ACTIVE: Product device recommended for new designs.

LIFEBUY: TI has announced that the device will be discontinued, and a lifetime-buy period is in effect.

NRND: Not recommended for new designs. Device is in production to support existing customers, but TI does not recommend using this part in a new design.

PREVIEW: Device has been announced but is not in production. Samples may or may not be available.

OBSELETE: TI has discontinued the production of the device.

⁽²⁾ **RoHS:** TI defines "RoHS" to mean semiconductor products that are compliant with the current EU RoHS requirements for all 10 RoHS substances, including the requirement that RoHS substance do not exceed 0.1% by weight in homogeneous materials. Where designed to be soldered at high temperatures, "RoHS" products are suitable for use in specified lead-free processes. TI may reference these types of products as "Pb-Free".

RoHS Exempt: TI defines "RoHS Exempt" to mean products that contain lead but are compliant with EU RoHS pursuant to a specific EU RoHS exemption.

Green: TI defines "Green" to mean the content of Chlorine (Cl) and Bromine (Br) based flame retardants meet JS709B low halogen requirements of ≤ 1000 ppm threshold. Antimony trioxide based flame retardants must also meet the ≤ 1000 ppm threshold requirement.

⁽³⁾ MSL, Peak Temp. - The Moisture Sensitivity Level rating according to the JEDEC industry standard classifications, and peak solder temperature.

⁽⁴⁾ There may be additional marking, which relates to the logo, the lot trace code information, or the environmental category on the device.

⁽⁵⁾ Multiple Device Markings will be inside parentheses. Only one Device Marking contained in parentheses and separated by a "~" will appear on a device. If a line is indented then it is a continuation of the previous line and the two combined represent the entire Device Marking for that device.

⁽⁶⁾ Lead/Ball Finish - Orderable Devices may have multiple material finish options. Finish options are separated by a vertical ruled line. Lead/Ball Finish values may wrap to two lines if the finish value exceeds the maximum column width.

Important Information and Disclaimer: The information provided on this page represents TI's knowledge and belief as of the date that it is provided. TI bases its knowledge and belief on information provided by third parties, and makes no representation or warranty as to the accuracy of such information. Efforts are underway to better integrate information from third parties. TI has taken and continues to take reasonable steps to provide representative and accurate information but may not have conducted destructive testing or chemical analysis on incoming materials and chemicals. TI and TI suppliers consider certain information to be proprietary, and thus CAS numbers and other limited information may not be available for release.

In no event shall TI's liability arising out of such information exceed the total purchase price of the TI part(s) at issue in this document sold by TI to Customer on an annual basis.

TAPE AND REEL INFORMATION

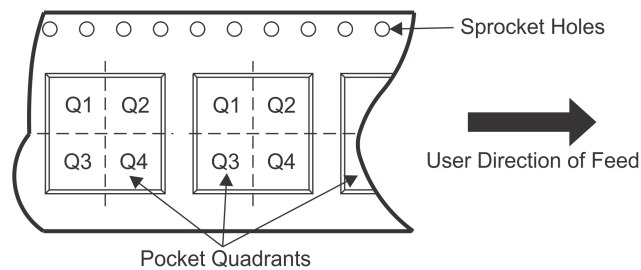
QUADRANT ASSIGNMENTS FOR PIN 1 ORIENTATION IN TAPE

*All dimensions are nominal

Device	Package Type	Package Drawing	Pins	SPQ	Reel Diameter (mm)	Reel Width W1 (mm)	A0 (mm)	B0 (mm)	K0 (mm)	P1 (mm)	W (mm)	Pin1 Quadrant
BQ24260RGER	VQFN	RGE	24	3000	330.0	12.4	4.25	4.25	1.15	8.0	12.0	Q2
BQ24260RGET	VQFN	RGE	24	250	180.0	12.4	4.25	4.25	1.15	8.0	12.0	Q2
BQ24260YFFR	DSBGA	YFF	36	3000	180.0	8.4	2.54	2.54	0.76	4.0	8.0	Q1
BQ24260YFFT	DSBGA	YFF	36	250	180.0	8.4	2.54	2.54	0.76	4.0	8.0	Q1
BQ24261MRGER	VQFN	RGE	24	3000	330.0	12.4	4.25	4.25	1.15	8.0	12.0	Q2
BQ24261MRGET	VQFN	RGE	24	250	180.0	12.4	4.25	4.25	1.15	8.0	12.0	Q2
BQ24261MYFFR	DSBGA	YFF	36	3000	180.0	8.4	2.54	2.54	0.76	4.0	8.0	Q1
BQ24261MYFFT	DSBGA	YFF	36	250	180.0	8.4	2.54	2.54	0.76	4.0	8.0	Q1
BQ24261RGER	VQFN	RGE	24	3000	330.0	12.4	4.25	4.25	1.15	8.0	12.0	Q2
BQ24261RGET	VQFN	RGE	24	250	180.0	12.4	4.25	4.25	1.15	8.0	12.0	Q2
BQ24261YFFR	DSBGA	YFF	36	3000	180.0	8.4	2.54	2.54	0.76	4.0	8.0	Q1
BQ24261YFFT	DSBGA	YFF	36	250	180.0	8.4	2.54	2.54	0.76	4.0	8.0	Q1
BQ24262RGER	VQFN	RGE	24	3000	330.0	12.4	4.25	4.25	1.15	8.0	12.0	Q2
BQ24262RGET	VQFN	RGE	24	250	180.0	12.4	4.25	4.25	1.15	8.0	12.0	Q2
BQ24262YFFR	DSBGA	YFF	36	3000	180.0	8.4	2.54	2.54	0.76	4.0	8.0	Q1
BQ24262YFFT	DSBGA	YFF	36	250	180.0	8.4	2.54	2.54	0.76	4.0	8.0	Q1

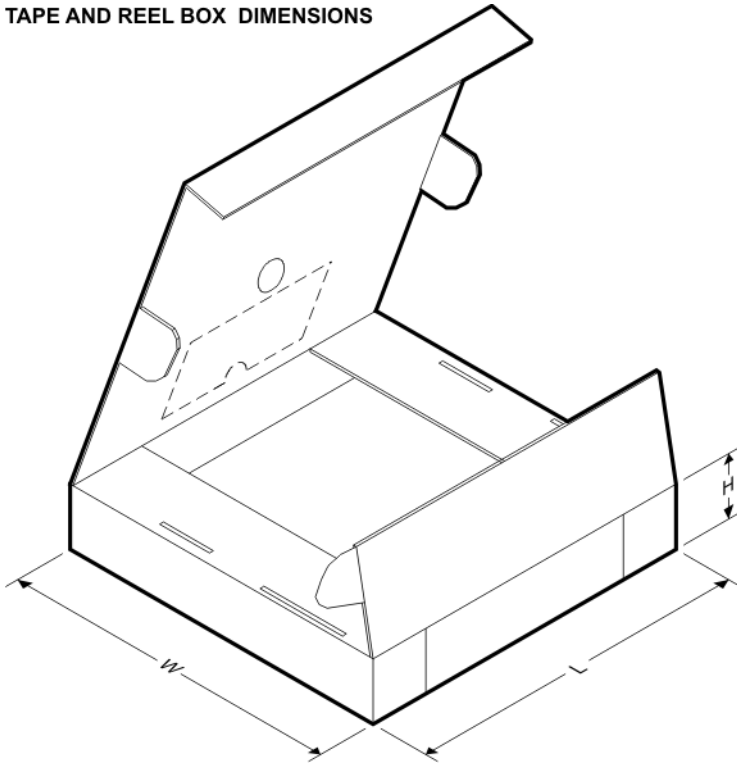
TAPE AND REEL BOX DIMENSIONS

*All dimensions are nominal

Device	Package Type	Package Drawing	Pins	SPQ	Length (mm)	Width (mm)	Height (mm)
BQ24260RGER	VQFN	RGE	24	3000	367.0	367.0	35.0
BQ24260RGET	VQFN	RGE	24	250	210.0	185.0	35.0
BQ24260YFFR	DSBGA	YFF	36	3000	182.0	182.0	20.0
BQ24260YFFT	DSBGA	YFF	36	250	182.0	182.0	20.0
BQ24261MRGER	VQFN	RGE	24	3000	367.0	367.0	35.0
BQ24261MRGET	VQFN	RGE	24	250	210.0	185.0	35.0
BQ24261MYFFR	DSBGA	YFF	36	3000	182.0	182.0	20.0
BQ24261MYFFT	DSBGA	YFF	36	250	182.0	182.0	20.0
BQ24261RGER	VQFN	RGE	24	3000	367.0	367.0	35.0
BQ24261RGET	VQFN	RGE	24	250	210.0	185.0	35.0
BQ24261YFFR	DSBGA	YFF	36	3000	182.0	182.0	20.0
BQ24261YFFT	DSBGA	YFF	36	250	182.0	182.0	20.0
BQ24262RGER	VQFN	RGE	24	3000	367.0	367.0	35.0
BQ24262RGET	VQFN	RGE	24	250	210.0	185.0	35.0
BQ24262YFFR	DSBGA	YFF	36	3000	182.0	182.0	20.0
BQ24262YFFT	DSBGA	YFF	36	250	182.0	182.0	20.0

YFF0036

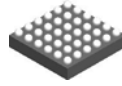

PACKAGE OUTLINE

DSBGA - 0.625 mm max height

DIE SIZE BALL GRID ARRAY

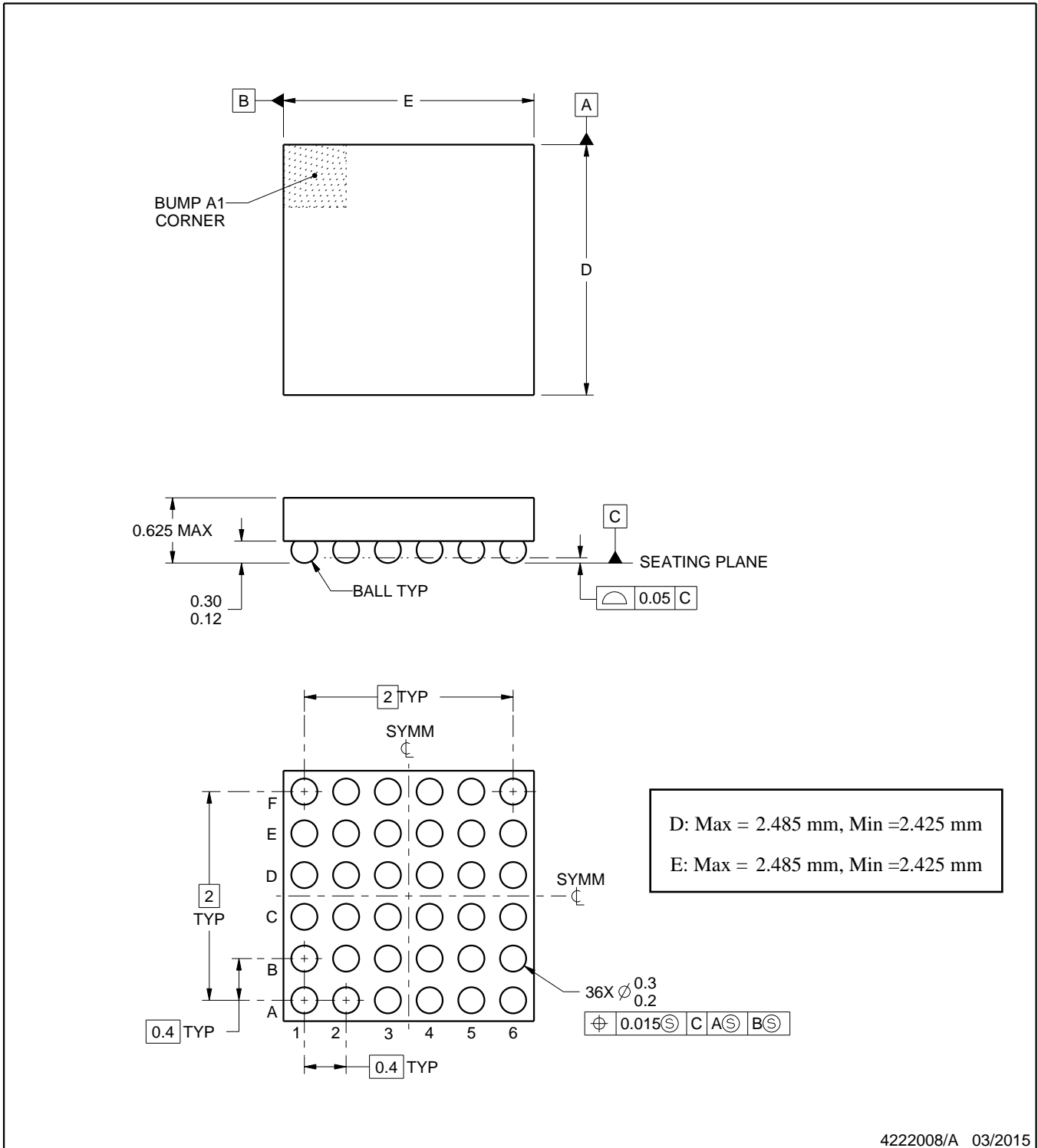

4222008/A 03/2015

NOTES:

1. All linear dimensions are in millimeters. Any dimensions in parenthesis are for reference only. Dimensioning and tolerancing per ASME Y14.5M.
2. This drawing is subject to change without notice.

EXAMPLE BOARD LAYOUT

YFF0036

DSBGA - 0.625 mm max height

DIE SIZE BALL GRID ARRAY

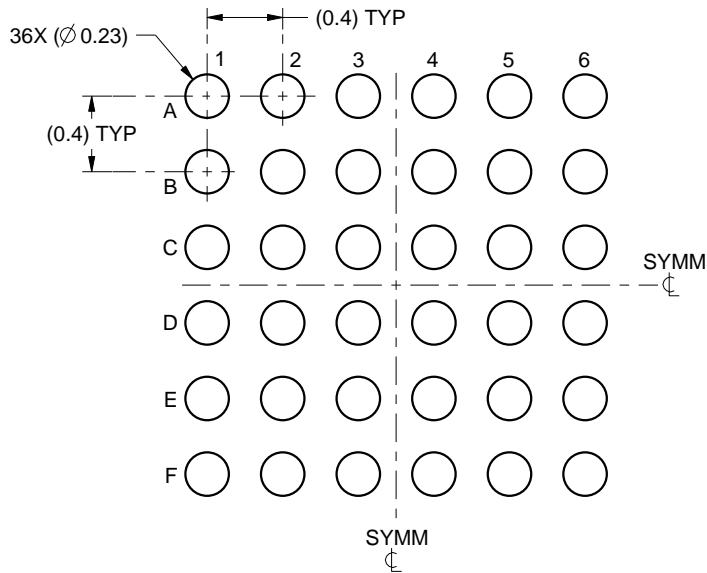

LAND PATTERN EXAMPLE
SCALE:25X

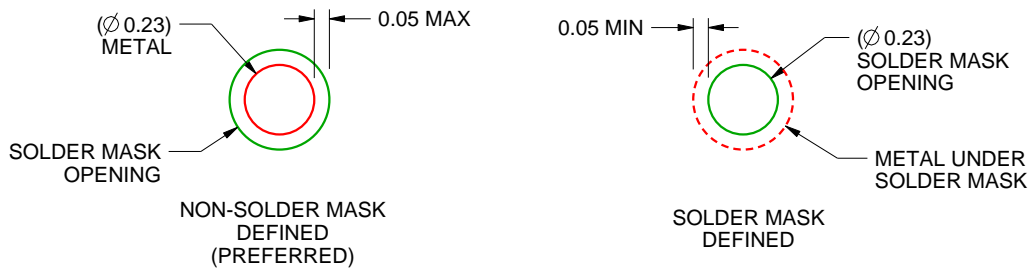

SOLDER MASK DETAILS
NOT TO SCALE

4222008/A 03/2015

NOTES: (continued)

- Final dimensions may vary due to manufacturing tolerance considerations and also routing constraints. For more information, see Texas Instruments literature number SNVA009 (www.ti.com/lit/snva009).

EXAMPLE STENCIL DESIGN

YFF0036

DSBGA - 0.625 mm max height

DIE SIZE BALL GRID ARRAY

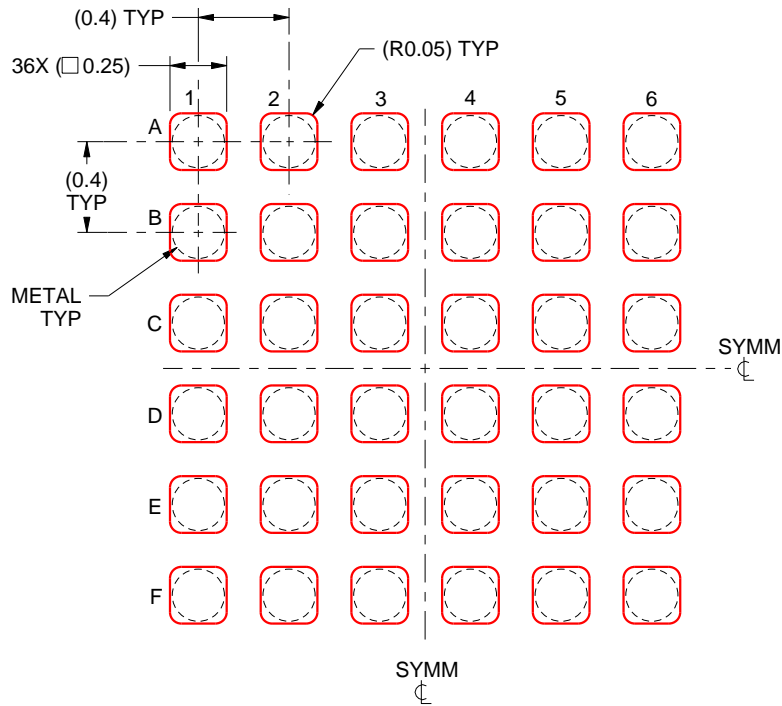

SOLDER PASTE EXAMPLE
BASED ON 0.1 mm THICK STENCIL
SCALE:30X

4222008/A 03/2015

NOTES: (continued)

4. Laser cutting apertures with trapezoidal walls and rounded corners may offer better paste release.

RGE 24

GENERIC PACKAGE VIEW

VQFN - 1 mm max height

PLASTIC QUAD FLATPACK - NO LEAD

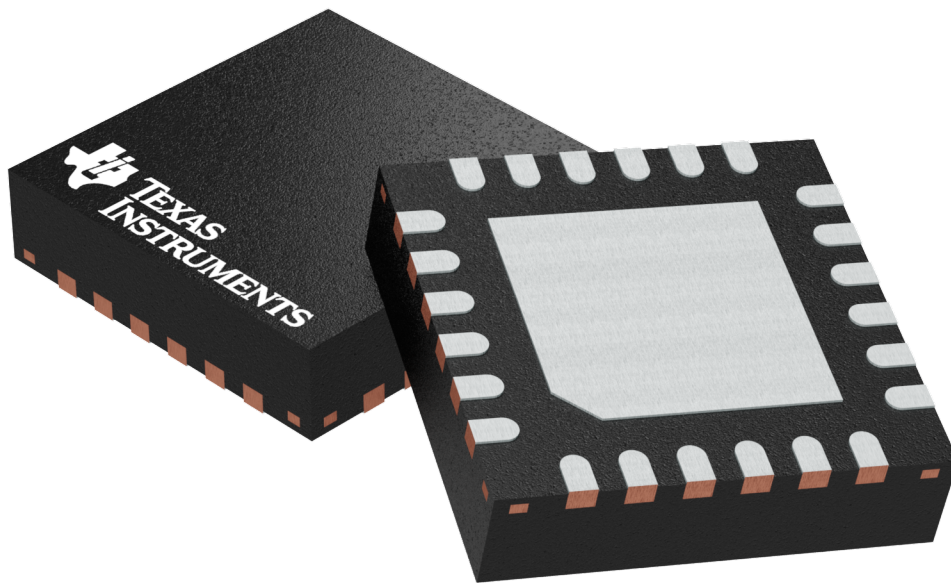

Images above are just a representation of the package family, actual package may vary.
Refer to the product data sheet for package details.

4204104/H

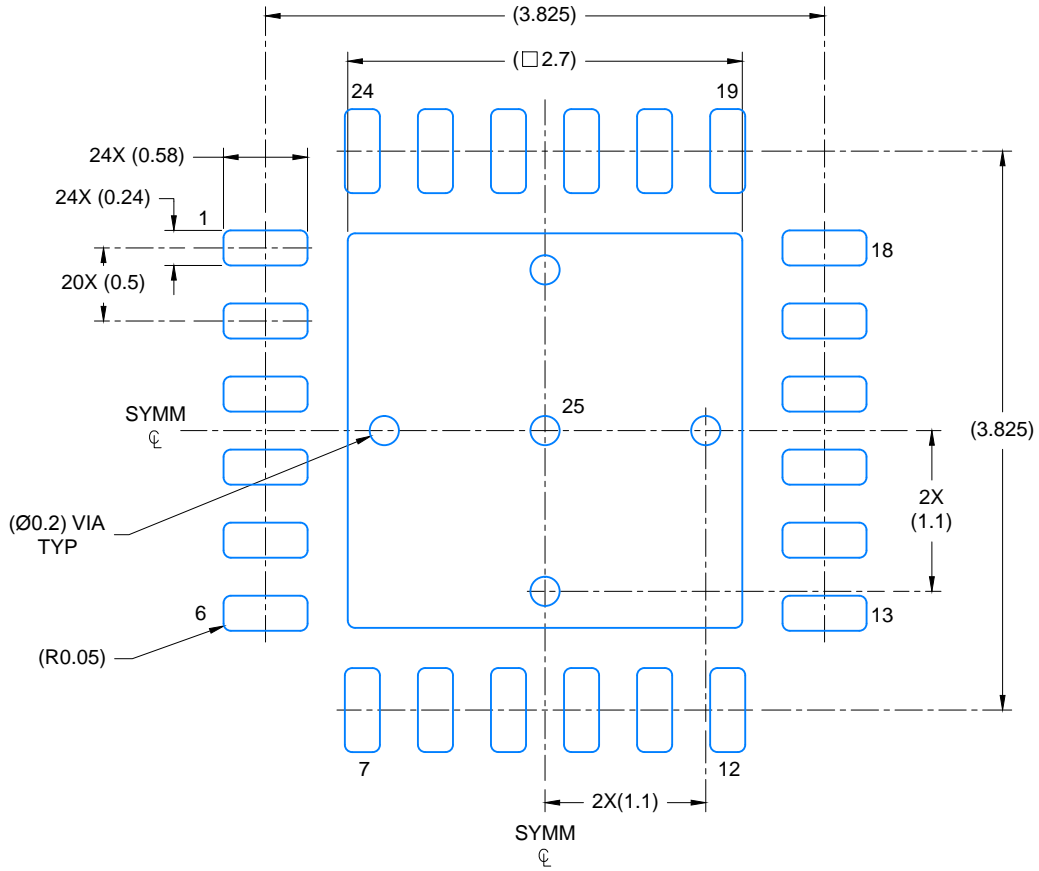

LAND PATTERN EXAMPLE
SCALE: 20X

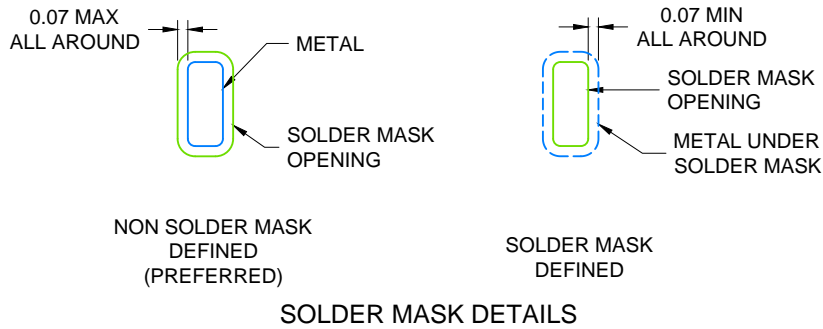

4219016 / A 08/2017

NOTES: (continued)

4. This package is designed to be soldered to a thermal pad on the board. For more information, see Texas Instruments literature number SLUA271 (www.ti.com/lit/slua271).
5. Solder mask tolerances between and around signal pads can vary based on board fabrication site.

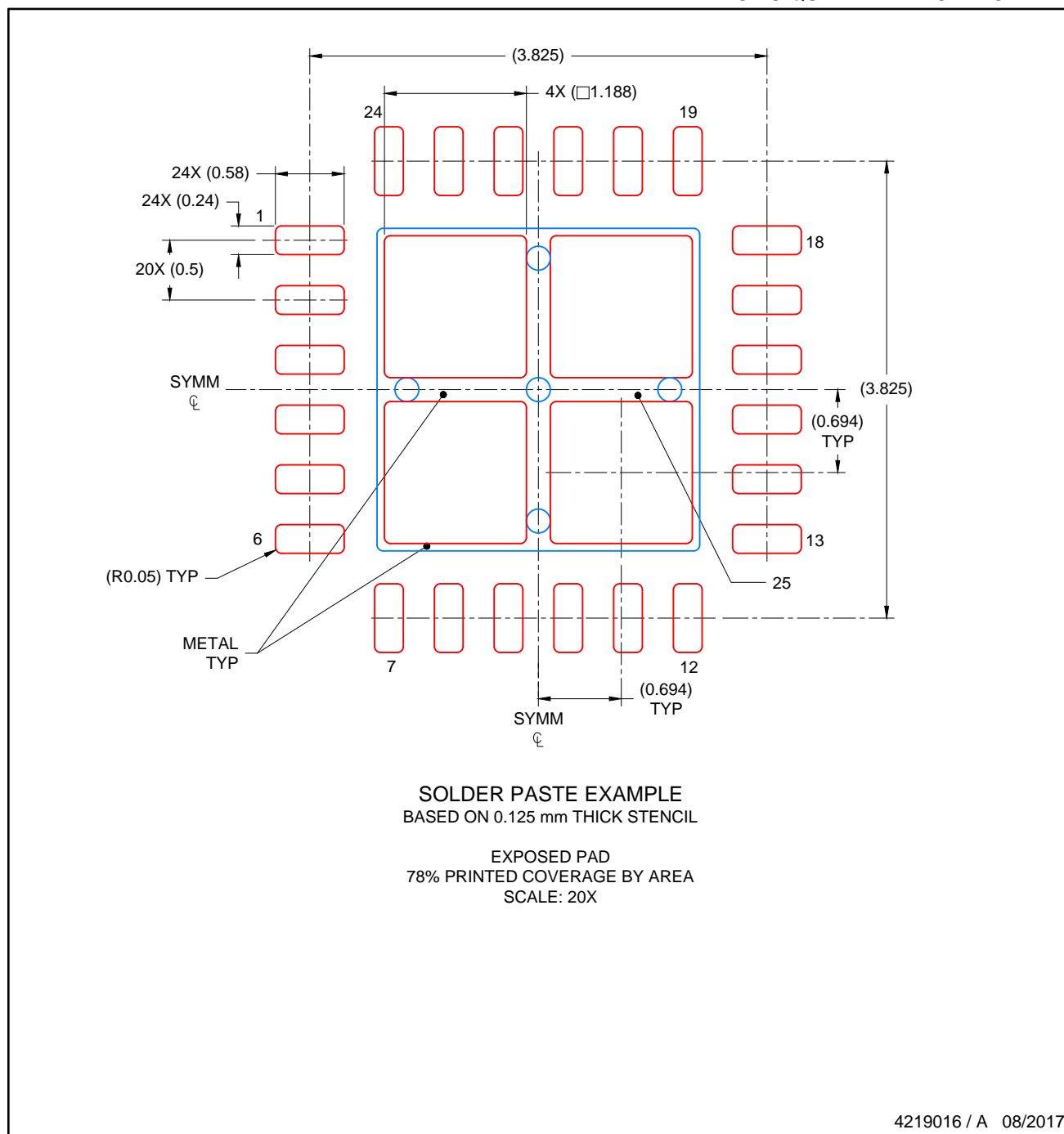

NOTES: (continued)

- 6. Laser cutting apertures with trapezoidal walls and rounded corners may offer better paste release. IPC-7525 may have alternate design recommendations..

IMPORTANT NOTICE AND DISCLAIMER

TI PROVIDES TECHNICAL AND RELIABILITY DATA (INCLUDING DATASHEETS), DESIGN RESOURCES (INCLUDING REFERENCE DESIGNS), APPLICATION OR OTHER DESIGN ADVICE, WEB TOOLS, SAFETY INFORMATION, AND OTHER RESOURCES "AS IS" AND WITH ALL FAULTS, AND DISCLAIMS ALL WARRANTIES, EXPRESS AND IMPLIED, INCLUDING WITHOUT LIMITATION ANY IMPLIED WARRANTIES OF MERCHANTABILITY, FITNESS FOR A PARTICULAR PURPOSE OR NON-INFRINGEMENT OF THIRD PARTY INTELLECTUAL PROPERTY RIGHTS.

These resources are intended for skilled developers designing with TI products. You are solely responsible for (1) selecting the appropriate TI products for your application, (2) designing, validating and testing your application, and (3) ensuring your application meets applicable standards, and any other safety, security, or other requirements. These resources are subject to change without notice. TI grants you permission to use these resources only for development of an application that uses the TI products described in the resource. Other reproduction and display of these resources is prohibited. No license is granted to any other TI intellectual property right or to any third party intellectual property right. TI disclaims responsibility for, and you will fully indemnify TI and its representatives against, any claims, damages, costs, losses, and liabilities arising out of your use of these resources.

TI's products are provided subject to TI's Terms of Sale (www.ti.com/legal/termsofsale.html) or other applicable terms available either on ti.com or provided in conjunction with such TI products. TI's provision of these resources does not expand or otherwise alter TI's applicable warranties or warranty disclaimers for TI products.

Mailing Address: Texas Instruments, Post Office Box 655303, Dallas, Texas 75265
Copyright © 2019, Texas Instruments Incorporated

Looking for pricing, stock, or lifecycle information?

Click below to explore more details on WIN SOURCE:

 [View BQ24261MYFFT](#) on WIN SOURCE

 [Texas Instruments](#) Information

Optimize Your Supply Chain with WIN SOURCE Solutions

-  Global Sourcing Solution
-  Obsolete Management
-  Cost Control Management
-  Shortage Management
-  Alternative Solution
-  Excess Inventory Management