



**THE DATASHEET OF
MAX776ESA+**



-5V/-12V/-15V or Adjustable, High-Efficiency, Low I_Q Inverting DC-to-DC Controllers

General Description

The MAX774/MAX775/MAX776 inverting switching regulators deliver high efficiency over three decades of load current. A unique current-limited, pulse-frequency modulated (PFM) control scheme provides the benefits of pulse-width modulation (high efficiency with heavy loads), while using less than 100 μ A of supply current (vs. 2mA to 10mA for PWM converters). The result is high efficiency over a wide range of loads.

These ICs also use tiny external components; their high switching frequency (up to 300kHz) allows for less than 5mm diameter surface-mount magnetics.

The MAX774/MAX775/MAX776 accept input voltages from 3V to 16.5V, and have preset output voltages of -5V, -12V, and -15V, respectively. Or, the output voltage can be user-adjusted with two resistors. Maximum $V_{IN} - V_{OUT}$ differential voltage is limited only by the breakdown voltage of the chosen external switch transistor.

These inverters use external P-channel MOSFET switches, allowing them to power loads up to 5W. If less power is required, use the MAX764/MAX765/MAX766 inverting switching regulators with on-board MOSFETs.

Applications

LCD-Bias Generators
High-Efficiency DC-to-DC Converters
Battery-Powered Applications
Data Communicators

Typical Operating Circuit

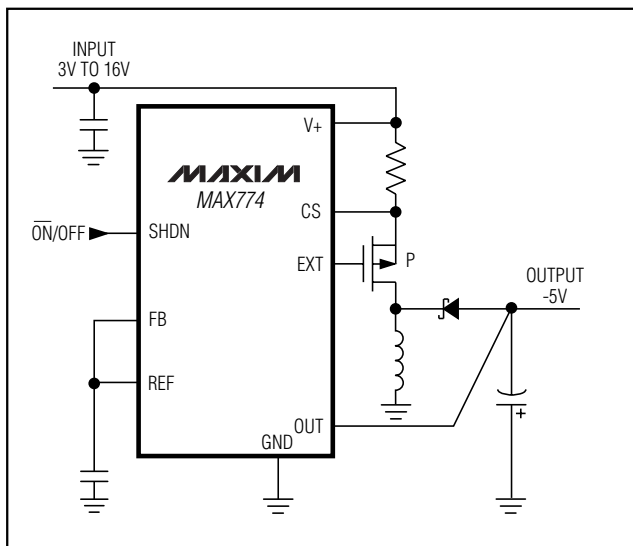

Features

- ◆ 85% Efficiency for 5mA to 1A Load Currents
- ◆ Up to 5W Output Power
- ◆ 100 μ A (max) Supply Current
- ◆ 5 μ A (max) Shutdown Current
- ◆ 3V to 16.5V Input Range
- ◆ -5V (MAX774), -12V (MAX775), -15V (MAX776), or Adjustable Output Voltage
- ◆ Current-Limited PFM Control Scheme
- ◆ 300kHz Switching Frequency

Ordering Information

PART	TEMP RANGE	PIN-PACKAGE
MAX774CPA	0°C to +70°C	8 Plastic DIP
MAX774CSA	0°C to +70°C	8 SO
MAX774C/D	0°C to +70°C	Dice*
MAX774EPA	-40°C to +85°C	8 Plastic DIP
MAX774ESA	-40°C to +85°C	8 SO
MAX774MJA	-55°C to +125°C	8 CERDIP

*Contact factory for dice specifications.

Ordering Information continued on last page.

Pin Configuration

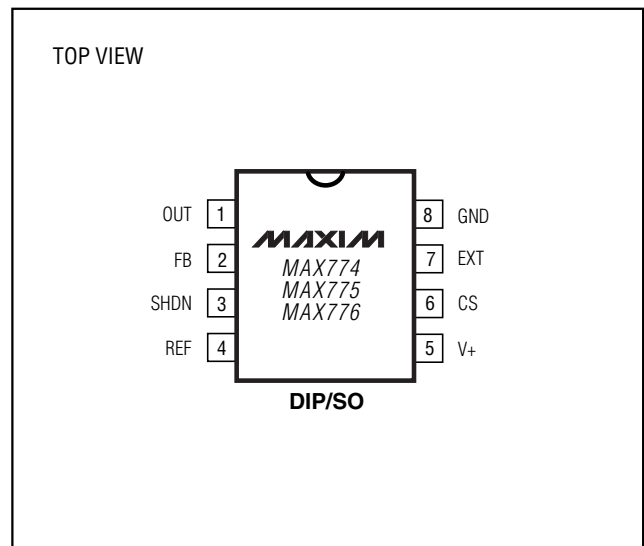

-5V/-12V/-15V or Adjustable, High-Efficiency, Low I_Q Inverting DC-to-DC Controllers

ABSOLUTE MAXIMUM RATINGS

Supply Voltages	
V+ to OUT	21V
V+ to GND	-0.3V, +17V
OUT to GND	-0.3V, to -17V
REF, SHDN, FB, CS	-0.3V to (V+ + 0.3V)
EXT	(V _{OUT} - 0.3V) to (V+ + 0.3V)
Continuous Power Dissipation (T _A = +70°C)	
Plastic DIP (derate 9.09mW/°C above +70°C)	727mW
SO (derate 5.88mW/°C above +70°C)	471mW
CERDIP (derate 8.00mW/°C above +70°C)	640mW

Operating Temperature Ranges:	
MAX77_C__	0°C to +70°C
MAX77_E__	-40°C to +85°C
MAX77_MJA	-55°C to +125°C
Maximum Junction Temperatures:	
MAX77_C__/E__	+150°C
MAX77_MJA	+175°C
Storage Temperature Range	-65°C to +160°C
Lead Temperature (soldering, 10s)	+300°C

Stresses beyond those listed under "Absolute Maximum Ratings" may cause permanent damage to the device. These are stress ratings only, and functional operation of the device at these or any other conditions beyond those indicated in the operational sections of the specifications is not implied. Exposure to absolute maximum rating conditions for extended periods may affect device reliability.

ELECTRICAL CHARACTERISTICS

(V+ = 5V, I_{LOAD} = 0mA, C_{REF} = 0.1μF, T_A = T_{MIN} to T_{MAX}, unless otherwise noted. Typical values are at T_A = +25°C.)

PARAMETER	SYMBOL	CONDITIONS	MIN	TYP	MAX	UNITS	
V+ Input Voltage Range	V+		3.0		16.5	V	
Supply Current		V+ = 16.5V, SHDN ≤ 0.4V (operating)			100	μA	
		V+ = 10V, SHDN ≥ 1.6V (shutdown)		2	5		
		V+ = 16.5V, SHDN ≥ 1.6V (shutdown)		4			
FB Trip Point		3V ≤ V+ ≤ 16.5V	-10		10	mV	
FB Input Current	I _{FB}	MAX77_C			±50	nA	
		MAX77_E			±70		
		MAX77_M			±90		
Output Voltage	V _{OUT}	MAX774	-4.80	-5	-5.20	V	
		MAX775	-11.52	-12	-12.48		
		MAX776	-14.40	-15	-15.60		
Reference Voltage	V _{REF}	I _{REF} = 0μA	MAX77_C	1.4700	1.5	1.5300	V
			MAX77_E	1.4625	1.5	1.5375	
			MAX77_M	1.4550	1.5	1.5450	
REF Load Regulation		0μA ≤ I _{REF} ≤ 100μA	MAX77_C/E		4	10	mV
			MAX77_M		4	15	
REF Line Regulation		3V ≤ V+ ≤ 16.5V		40	100	μV/V	
Output Voltage Line Regulation (Circuit of Figure 2— Bootstrapped)		MAX774, 4V ≤ V+ ≤ 15V, I _{LOAD} = 0.5A		0.035		mV/V	
		MAX775, 4V ≤ V+ ≤ 8V, I _{LOAD} = 0.2A		0.088			
		MAX776, 4V ≤ V+ ≤ 6V, I _{LOAD} = 0.1A		0.137			
Output Voltage Load Regulation (Circuit of Figure 2— Bootstrapped)		MAX774, 0A ≤ I _{LOAD} ≤ 1A, V+ = 5V		1.5		mV/A	
		MAX775, 0mA ≤ I _{LOAD} ≤ 500mA, V+ = 5V		1.5			
		MAX776, 0mA ≤ I _{LOAD} ≤ 400mA, V+ = 5V		1.0			

-5V/-12V/-15V or Adjustable, High-Efficiency, Low I_Q Inverting DC-to-DC Controllers

MAX774/MAX775/MAX776

ELECTRICAL CHARACTERISTICS (continued)

($V_+ = 5V$, $I_{LOAD} = 0mA$, $C_{REF} = 0.1\mu F$, $T_A = T_{MIN}$ to T_{MAX} , unless otherwise noted. Typical values are at $T_A = +25^\circ C$.)

PARAMETER	SYMBOL	CONDITIONS	MIN	TYP	MAX	UNITS	
Efficiency (Circuit of Figure 2— Bootstrapped)		MAX774, $V_+ = 5V$, $I_{LOAD} = 1A$		82		%	
		MAX775, $V_+ = 5V$, $I_{LOAD} = 500mA$		88			
		MAX776, $V_+ = 5V$, $I_{LOAD} = 400mA$		87			
SHDN Input Current		$V_+ = 16.5V$, SHDN = 0V or V_+			± 1	μA	
SHDN Input Voltage High	V_{IH}	$3V \leq V_+ \leq 16.5V$	1.6			V	
SHDN Input Voltage Low	V_{IL}	$3V \leq V_+ \leq 16.5V$	MAX77_C/E		0.4	V	
			MAX77_M		0.3		
Current-Limit Trip Level ($V_+ - CS$)	V_{CS}	$3V \leq V_+ \leq 16.5V$	MAX77_C/E	180	210	240	mV
			MAX77_M	160	210	260	
CS Input Current					± 1	μA	
Switch Maximum On-Time	$t_{ON(max)}$	$V_+ = 12V$	12	16	20	μs	
Switch Minimum Off-Time	$t_{OFF(max)}$	$V_+ = 12V$	1.8	2.3	2.8	μs	
EXT Rise Time		$C_{EXT} = 1nF$, $V_+ = 12V$		50		ns	
EXT Fall Time		$C_{EXT} = 1nF$, $V_+ = 12V$		50		ns	

-5V/-12V/-15V or Adjustable, High-Efficiency, Low I_Q Inverting DC-to-DC Controllers

Typical Operating Characteristics

($T_A = +25^\circ\text{C}$, unless otherwise noted.)

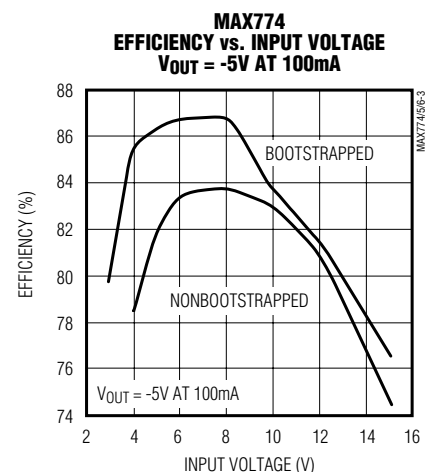
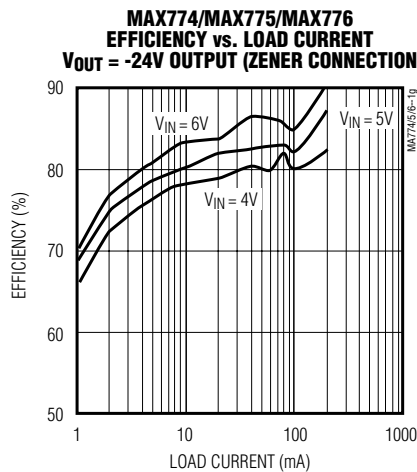
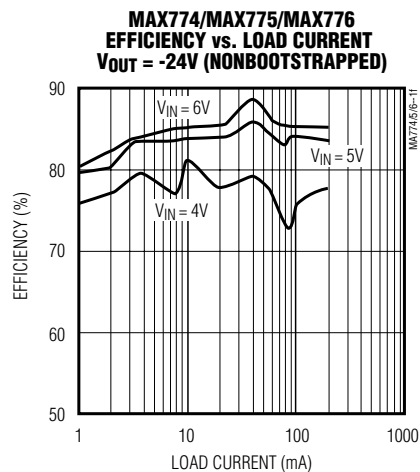
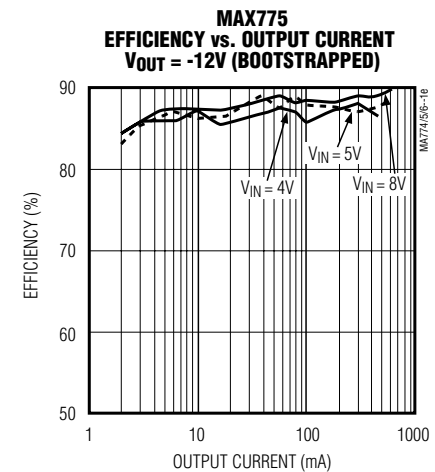
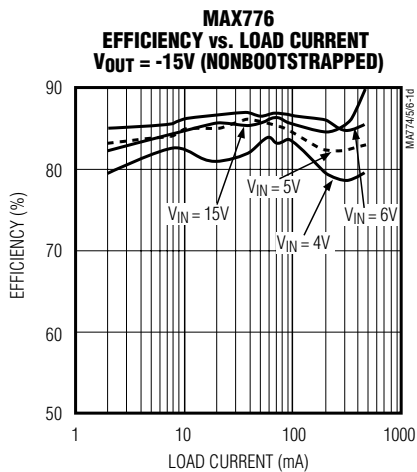
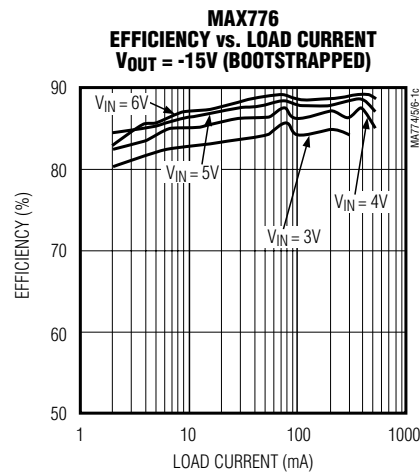
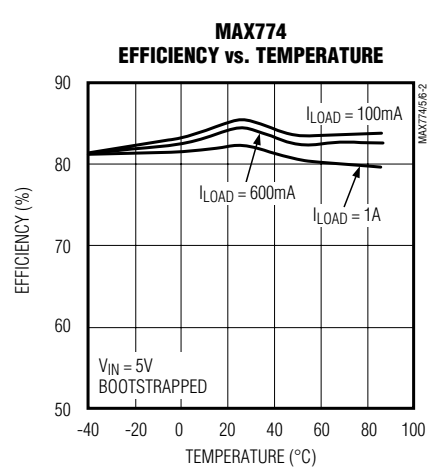
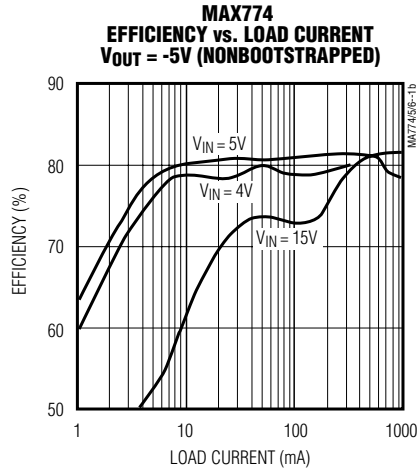
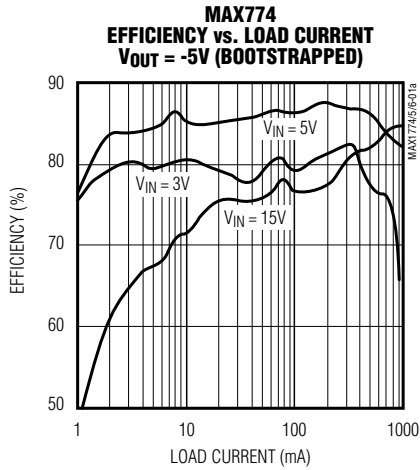

-5V/-12V/-15V or Adjustable, High-Efficiency, Low I_Q Inverting DC-to-DC Controllers

Typical Operating Characteristics (continued)

($T_A = +25^\circ\text{C}$, unless otherwise noted.)

MAX7774/MAX7775/MAX776

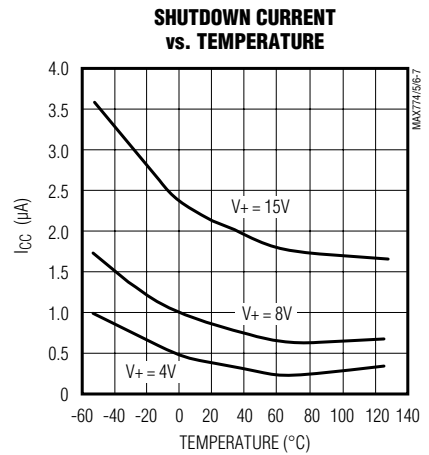
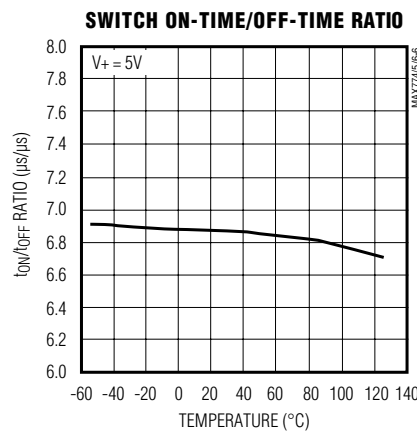
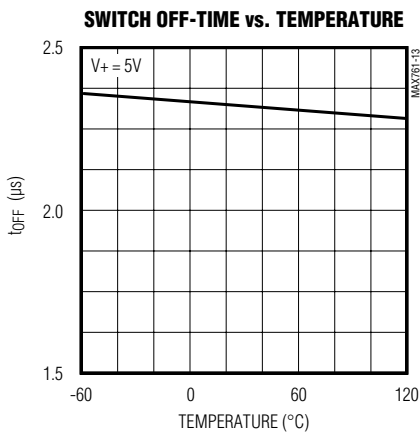
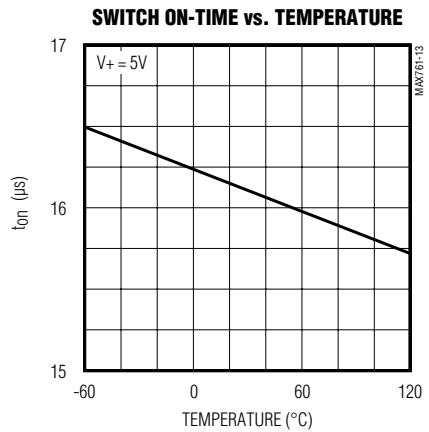
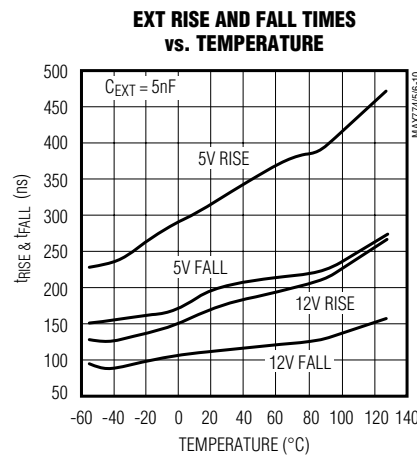
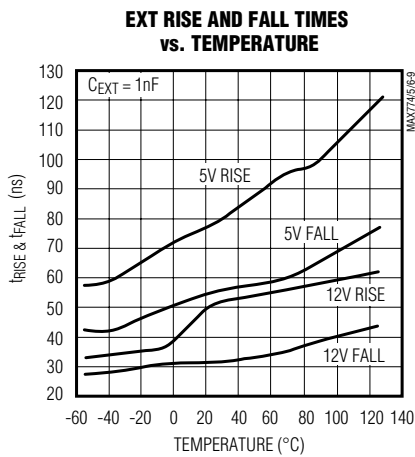
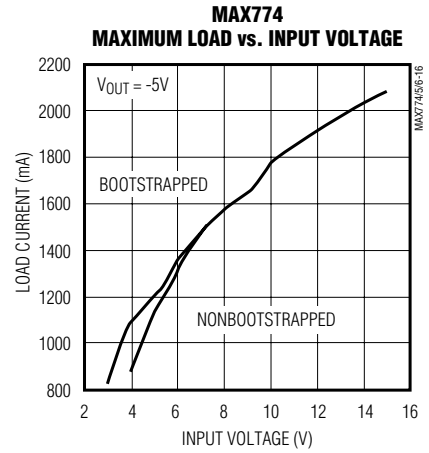
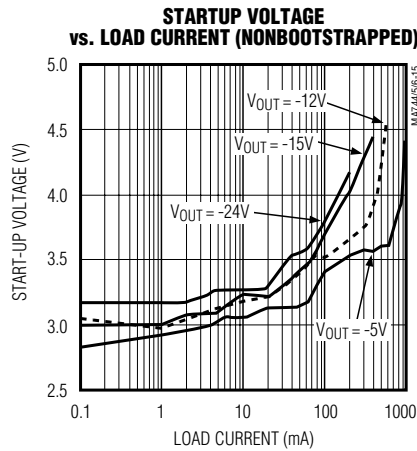
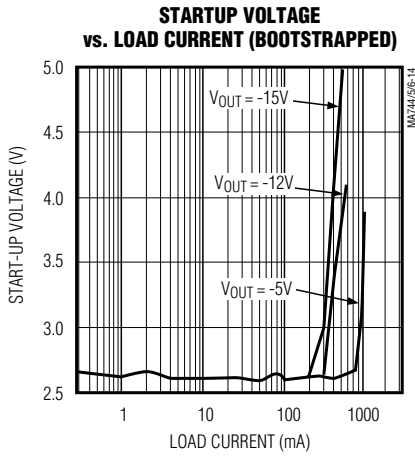

-5V/-12V/-15V or Adjustable, High-Efficiency, Low I_Q Inverting DC-to-DC Controllers

Typical Operating Characteristics (continued)

($T_A = +25^\circ\text{C}$, unless otherwise noted.)

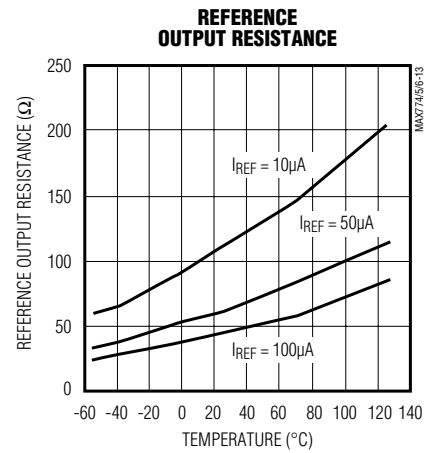
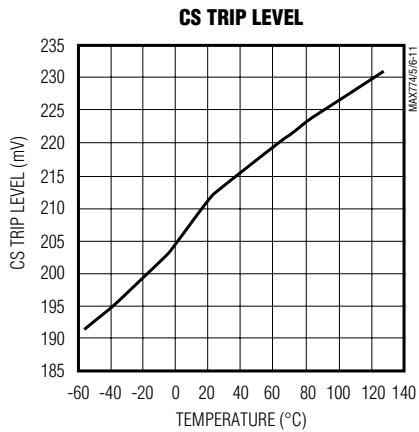
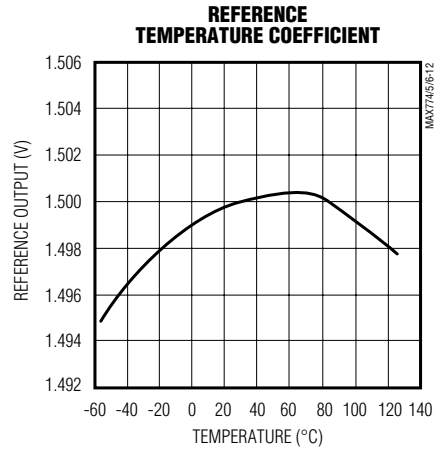
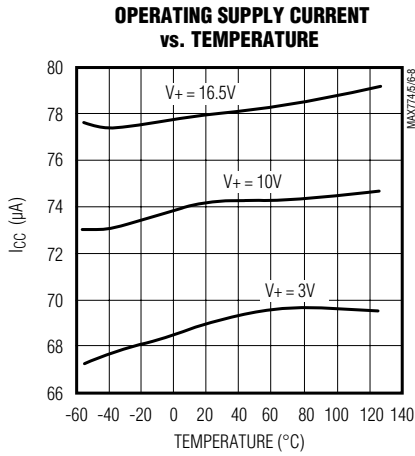

-5V/-12V/-15V or Adjustable, High-Efficiency, Low I_Q Inverting DC-to-DC Controllers

Typical Operating Characteristics

($T_A = +25^\circ\text{C}$, unless otherwise noted.)

MAX774/MAX775/MAX776

OPERATING WAVEFORMS

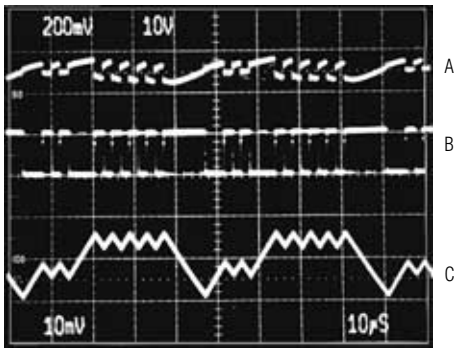

10μs/div

CIRCUIT OF FIGURE 2
 $V_+ = 6.5\text{V}$, $I_{\text{LOAD}} = 1\text{A}$, $V_{\text{OUT}} = -5\text{V}$
 A: OUTPUT RIPPLE, 200mV/div
 B: EXT WAVEFORM, 10V/div
 C: INDUCTOR CURRENT, 2A/div

INDUCTOR CURRENT NEAR FULL LOAD

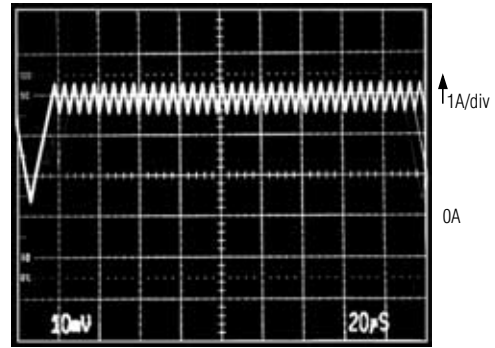

20μs/div

CIRCUIT OF FIGURE 2
 $V_{\text{OUT}} = -5\text{V}$, $V_+ = 4.7\text{V}$
 $I_{\text{LOAD}} = 1.05\text{A}$ (1A/div)

CONTINUOUS CONDUCTION AT ONE-HALF CURRENT LIMIT

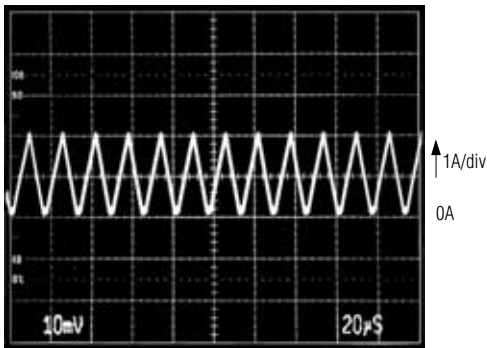

20μs/div

CIRCUIT OF FIGURE 2
 $I_{\text{LOAD}} = 300\text{mA}$, $V_{\text{OUT}} = -5\text{V}$
 $V_+ = 8\text{V}$, $L = 22\mu\text{H}$

ENTRY/EXIT FROM SHUTDOWN

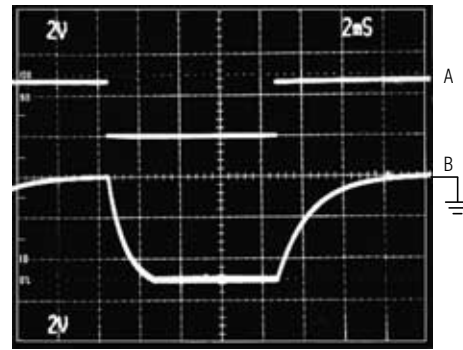

2ms/div

CIRCUIT OF FIGURE 2
 $V_+ = 6\text{V}$, $I_{\text{LOAD}} = 1\text{A}$, $V_{\text{OUT}} = -5\text{V}$
 A: SHUTDOWN PULSE, 0V TO V_+ , 5V/div
 B: V_{OUT} , 2V/div

-5V/-12V/-15V or Adjustable, High-Efficiency, Low I_Q Inverting DC-to-DC Controllers

Typical Operating Characteristics (continued)

($T_A = +25^\circ\text{C}$, unless otherwise noted.)

LOAD-TRANSIENT RESPONSE

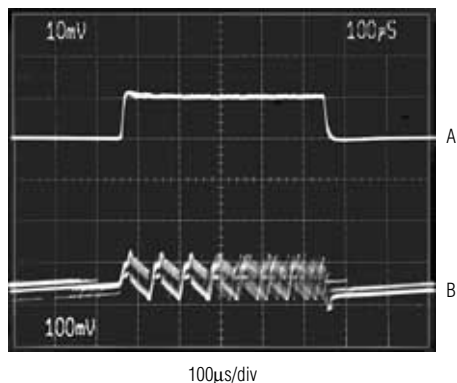

CIRCUIT OF FIGURE 2
 $V_+ = 6\text{V}$, $V_{\text{OUT}} = -5\text{V}$
 A: I_{LOAD} , 30mA TO 1A, 1A/div
 B: V_{OUT} , 100mV/div, AC-COUPLED

LINE-TRANSIENT RESPONSE

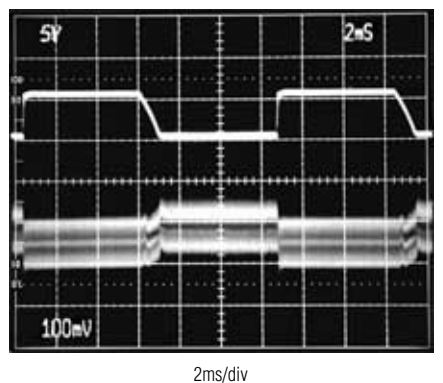

CIRCUIT OF FIGURE 2
 $V_{\text{OUT}} = -5\text{V}$, $I_{\text{LOAD}} = 1\text{A}$
 A: V_+ , 3V TO 8V, 5V/div
 B: V_{OUT} , 100mV/div, AC-COUPLED

Pin Description

PIN	NAME	FUNCTION
1	OUT	The sense input for fixed-output operation ($V_{\text{FB}} = V_{\text{REF}}$). OUT is connected to the internal voltage divider, and it is the negative supply input for the EXT driver.
2	FB	Feedback input. When $V_{\text{FB}} = V_{\text{REF}}$, the output will be the factory preset value. For adjustable operation, use an external voltage divider, as described in the <i>Adjustable Output</i> section.
3	SHDN	Active-high shutdown input. With SHDN high, the part is in shutdown mode and the supply current is less than $5\mu\text{A}$. Connect to GND for normal operation.
4	REF	1.5V reference output that can source $100\mu\text{A}$. Bypass to ground with $0.1\mu\text{F}$.
5	V_+	Positive power-supply input
6	CS	Noninverting input to the current-sense comparator. Typical trip level is 210mV (relative to V_+).
7	EXT	The gate-drive output for an external P-channel power MOSFET. EXT swings from OUT to V_+ .
8	GND	Ground

-5V/-12V/-15V or Adjustable, High-Efficiency, Low I_Q Inverting DC-to-DC Controllers

MAX774/MAX775/MAX776

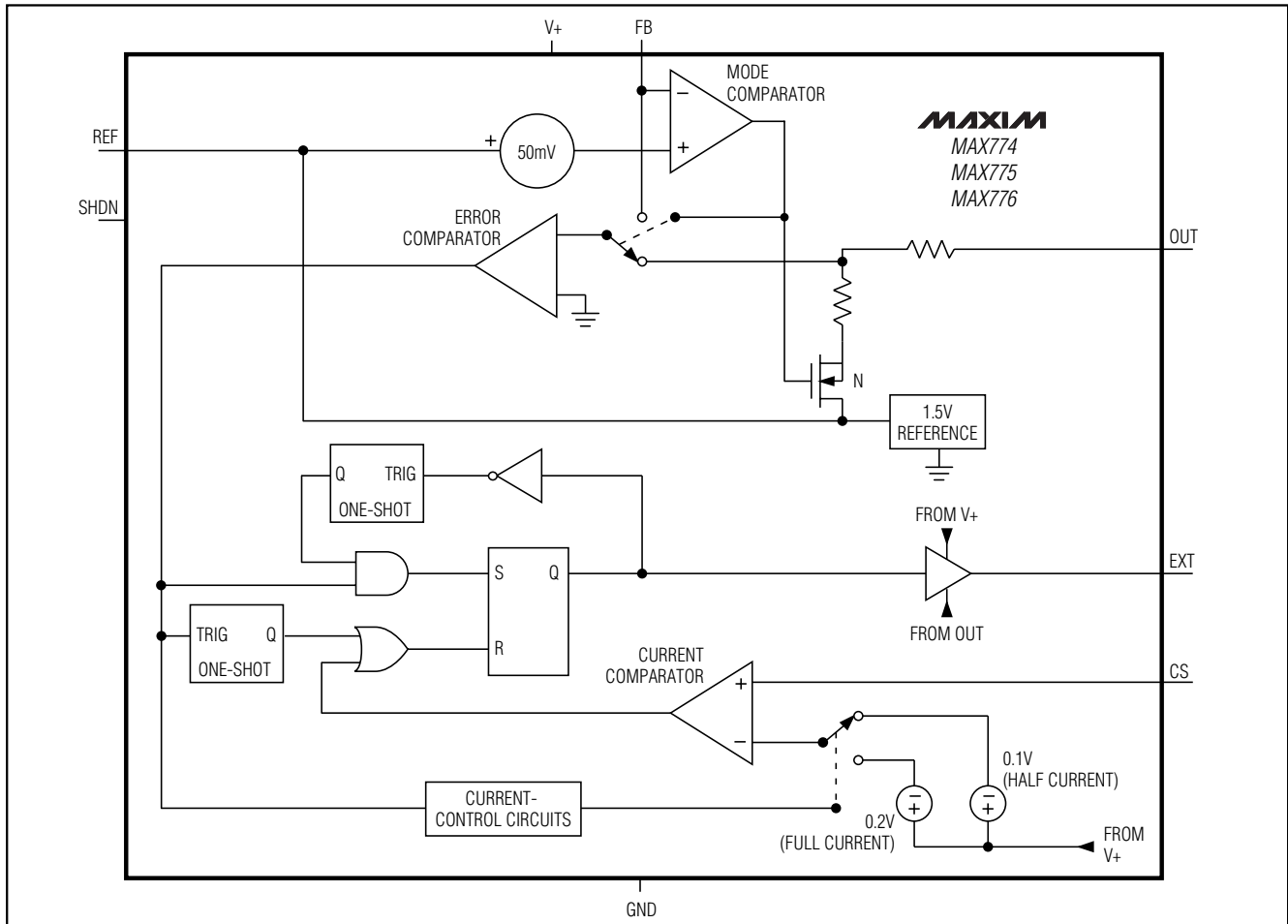

Figure 1. Functional Diagram

Detailed Description

The MAX774/MAX775/MAX776 are negative-output, inverting power controllers that can be configured to drive an external P-channel MOSFET. The output voltages are preset to -5V (MAX774), -12V (MAX775), or -15V (MAX776). Additionally, all three parts can be set to any desired output voltage using an external resistor divider.

The MAX774/MAX775/MAX776 have a unique control scheme (Figure 1) that combines the advantage of pulse-skipping, pulse-frequency-modulation (PFM) converters (ultra-low supply current) with the advantage of pulse-width modulation (PWM) converters (high efficiency with heavy loads). This control scheme allows the devices to achieve 85% efficiency with loads from 5mA to 1A.

As with traditional PFM converters, the external P-channel MOSFET power transistor is turned on when the voltage comparator senses that the output is below the reference voltage. However, unlike traditional PFM converters, switching is controlled by the combination of a switch current limit ($210\text{mV}/R_{\text{SENSE}}$) and on-time/off-time limits set by one-shots. Once turned on, the MOSFET stays on until the $16\mu\text{s}$ maximum on-time limit is reached or the switch current reaches its limit (as set by the current-sense resistor).

Once off, the switch is typically held off for a minimum of $2.3\mu\text{s}$. It will stay off until the output drops below the level determined by V_{REF} and the feedback divider network.

With light loads, the MOSFET switches on for one or more cycles and then switches off, much like in traditional PFM converters. To increase light-load efficiency,

-5V/-12V/-15V or Adjustable, High-Efficiency, Low I_Q Inverting DC-to-DC Controllers

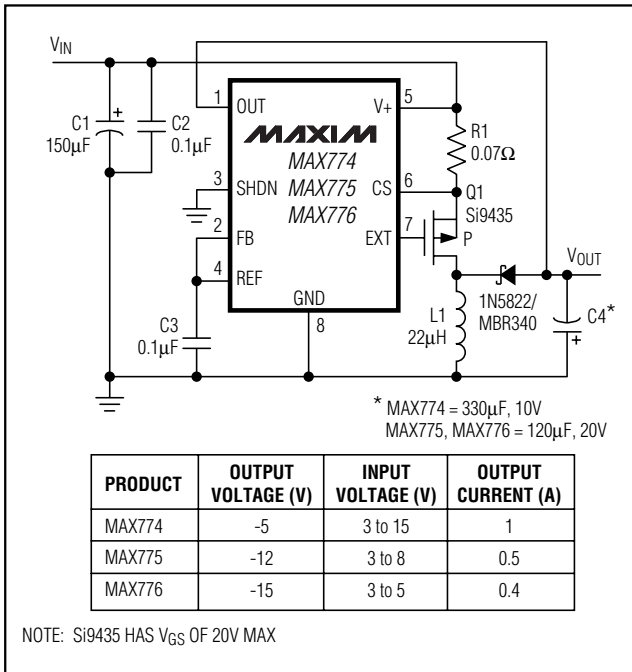

Figure 2. Bootstrapped Connection Using Fixed Output Voltages

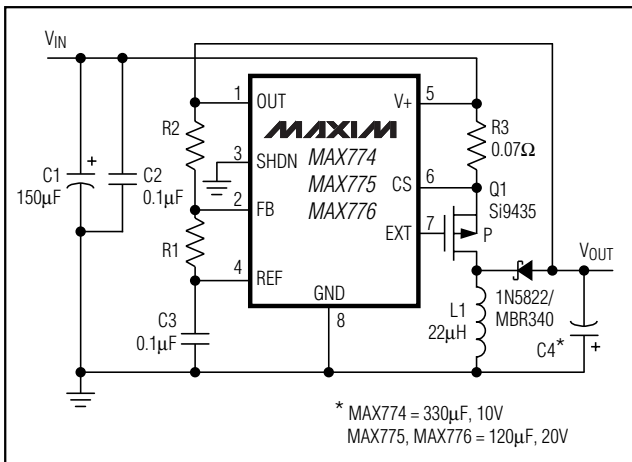

Figure 3. Bootstrapped Connection Using External Feedback Resistors

the current limit for the first two pulses is set to one-half the peak current limit. If those pulses bring the output voltage into regulation, the voltage comparator keeps the MOSFET off, and the current limit remains at one-half the peak current limit. If the output voltage is out of regulation after two consecutive pulses, the current limit

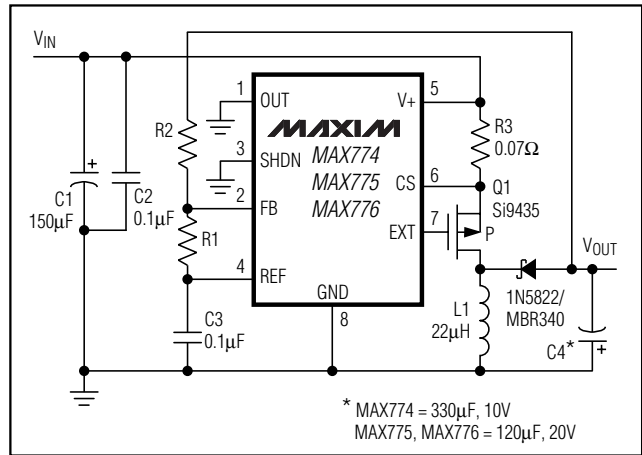

Figure 4. Nonbootstrapped Operation ($V_{IN} > 4.5V$)

for the next pulse will equal the full current limit.

With heavy loads, the MOSFET first switches twice at one-half the peak current value. Subsequently, it stays on until the switch current reaches the full current limit, and then turns off. After it is off for 2.3µs, the MOSFET switches on once more, and remains on until the switch current again reaches its limit. This cycle repeats until the output is in regulation.

A benefit of this control scheme is that it is highly efficient over a wide range of input/output ratios and load currents. Additionally, PFM converters do not operate with constant-frequency switching, and have relaxed stability criterion (unlike PWM converters). As a result, their external components require smaller values.

With PFM converters, the output voltage ripple is not concentrated at the oscillator frequency (as it is with PWM converters). For applications where the ripple frequency is important, the PWM control scheme must be used. However, for many other applications, the smaller capacitors and lower supply current of the PFM control scheme make it the better choice. The output voltage ripple with the MAX774/MAX775/MAX776 can be held quite low. For example, using the circuit of Figure 2, only 100mV of output ripple is produced when generating a -5V at 1A output from a +5V input.

Bootstrapped vs. Nonbootstrapped Operation

Figures 2 and 3 are the standard application circuits for bootstrapped mode, and Figure 4 is the circuit for nonbootstrapped mode. Since EXT is powered by OUT, using bootstrapped or nonbootstrapped mode will directly affect the gate drive to the FET. EXT swings from V+ to V_{OUT}. In bootstrapped operation, OUT is

-5V/-12V/-15V or Adjustable, High-Efficiency, Low I_Q Inverting DC-to-DC Controllers

MAX774/MAX775/MAX776

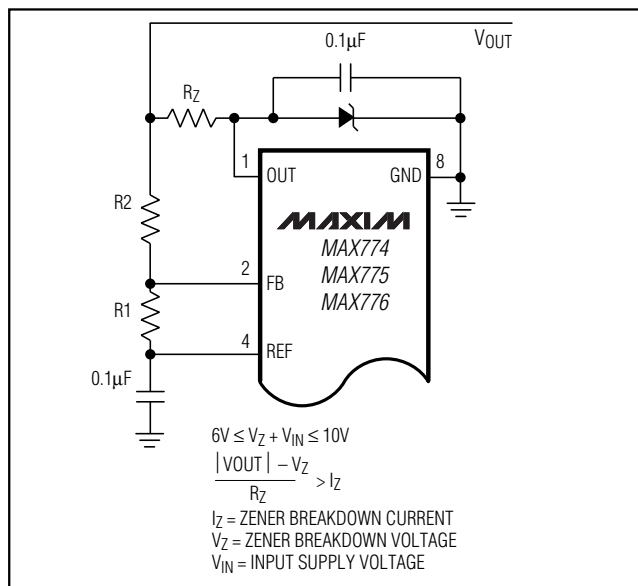

Figure 5. Connection Using Zener Diode to Boost Base Drive

connected to the output voltage (-5V, -12V, -15V). In nonbootstrapped operation, OUT is connected to ground, and EXT now swings from V+ to ground.

At high input-to-output differentials, it may be necessary to use nonbootstrapped mode to avoid the 21V V+ to V_{OUT} maximum rating. Also, observe the V_{GS} maximum rating of the external transistor. At intermediate voltages and currents, the advantages of bootstrapped vs. nonbootstrapped operation are slight. When input voltages are less than about 4V, always use the bootstrapped circuit.

Shutdown and Quiescent Current

The MAX774/MAX775/MAX776 are designed to save power in battery-powered applications. A TTL/CMOS logic-level shutdown input (SHDN) has been provided for the lowest-power applications. When shut down (SHDN = V+), most internal bias current sources and the reference are turned off so that less than 5µA of current is drawn.

In normal operation, the quiescent current will be less than 100µA. However, this current is measured by forcing the external switch transistor off. Even with no load, in an actual application, additional current will be drawn to supply the feedback resistors' and the diode's and capacitor's leakage current. Under no-load conditions, you should see a short current pulse at half the peak current approximately every 100ms (the exact period depends on actual circuit leakages).

EXT Drive Voltages

EXT swings from OUT to V+ and provides the drive output for an external power MOSFET. When using the on-chip feedback resistors for the preset output voltages, the voltage at OUT equals the output voltage. When using external feedback resistors, OUT may be tied to GND or some other potential between V_{OUT} and GND.

Always observe the V+ to OUT absolute maximum rating of 21V. For V+ to output differentials greater than 21V, OUT must be tied to a potential more positive than the output and, therefore, the output voltage must be set with an external resistor divider.

In nonbootstrapped operation with low input voltages (<4V), tie OUT to a negative voltage to fully enhance the external MOSFET. Accomplish this by creating an intermediate voltage for V_{OUT} with a zener diode (Figure 5).

Design Procedure

Setting the Output Voltage

The MAX774/MAX775/MAX776 are preset for -5V, -12V, and -15V output voltages, respectively; however, they may also be adjusted to other values with an external voltage divider. For the preset output voltage, connect FB to REF and connect OUT to the output (Figure 3). In this case, the output voltage is sensed by OUT.

For an adjustable output (Figures 3 and 4), connect an external resistor divider from the output voltage to FB, and from FB to REF. In this case, the divided-down output voltage is sensed via the FB pin.

There are three reasons to use the external resistor divider:

- 1) An output voltage other than a preset value is desired.
- 2) The input-to-output differential exceeds 21V.
- 3) The output voltage (V_{OUT} to GND) exceeds -15V.

See Figures 3 and 4 for adjustable operation. The impedance of the feedback network should be low enough that the input bias current of FB is not a factor. For best efficiency and precision, allow 10µA to flow through the network. Calculate (V_{REF} - V_{FB}) / R1 = 10µA. Since V_{REF} = 1.5V and V_{FB} = 0V, R1 becomes 150kΩ. Then calculate R2 as follows:

$$\frac{R2}{R1} = \frac{V_{OUT}}{V_{REF}}$$

$$\text{(or, } \frac{V_{OUT}}{R2} = 10\mu\text{A)}$$

Choosing an Inductor

Practical inductor values range from 10µH to 50µH. The maximum inductor value is not particularly critical. For highest current at high |V_{OUT}| to V+ ratios, the

-5V/-12V/-15V or Adjustable, High-Efficiency, Low I_Q Inverting DC-to-DC Controllers

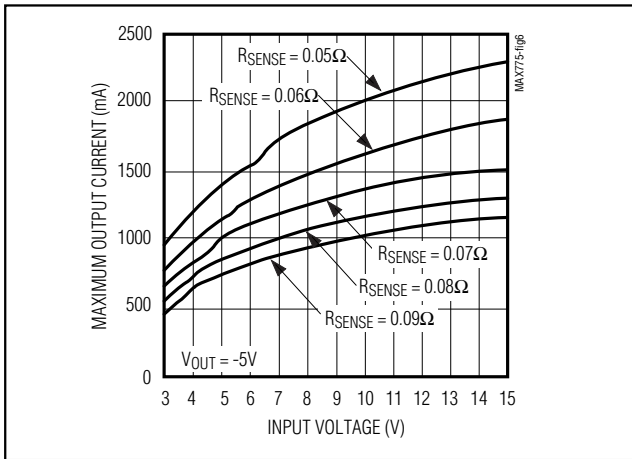

Figure 6. MAX774 Maximum Output Current vs. Input Voltage ($V_{OUT} = -5V$)

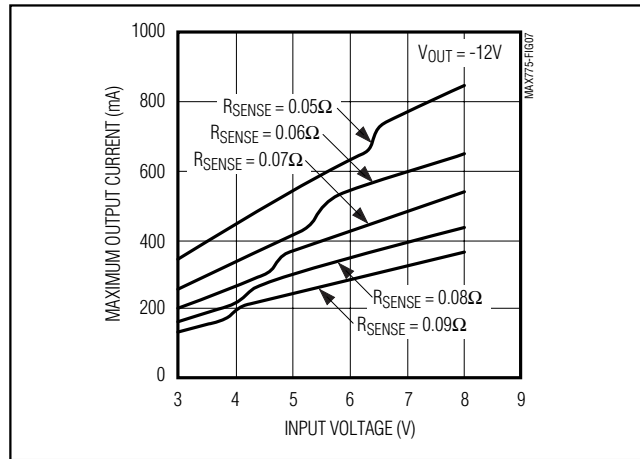

Figure 7. MAX775 Maximum Output Current vs. Input Voltage ($V_{OUT} = -12V$)

inductor should not be so large that the peak current never reaches the current limit. That is:

$$L(\max) \leq \frac{[V_{+}(\min) - V_{SW}(\max)] \times 12\mu s}{I_{LIM}(\max)}$$

This is only important if

$$\left| \frac{V_{IN}}{V_{OUT}} \right| < \frac{1}{6} = \frac{t_{OFF}(\min)}{t_{ON}(\max)}$$

More important is that the inductor not be so small that the current rises much faster than the current-limit comparator can respond. This would be wasteful and reduce efficiency. Calculate the minimum inductor value as follows:

$$L(\min) \geq \frac{[V_{+}(\max) - V_{SW}(\min)] \times 0.3\mu s}{\delta(I) \times I_{LIM}(\min)}$$

Where L is in μH , $0.3\mu s$ is an ample time for the comparator response, I_{LIM} is the current limit (see the *Current-Sense Resistor* section), and $\delta(I)$ is the allowable percentage of overshoot. As an example, Figure 2's circuit uses a 3A peak current. If we allow a 15% overshoot and 15V is the maximum input voltage, then $L(\min)$ is 16 μH . The actual value of L above this limit has minimal effect on this circuit's operation.

For highest efficiency, use a coil with low DC resistance. Coils with 30m Ω or lower resistance are available. To minimize radiated noise, use a torroid, pot-core, or shielded-bobbin inductor. Inductors with a ferrite core or equivalent

are recommended. Make sure that the inductor's saturation current rating is greater than $I_{LIM}(\max)$.

Diode Selection

The ICs' high switching frequencies demand a high-speed rectifier. Schottky diodes such as the 1N5817 to 1N5822 families are recommended. Choose a diode with an average current rating approximately equal to or greater than $I_{LIM}(\max)$ and a voltage rating higher than $V_{IN}(\max) + V_{OUT}$. For high-temperature applications, Schottky diodes may be inadequate due to their high leakage currents; instead, high-speed silicon diodes may be used. At heavy loads and high temperature, the benefits of a Schottky diode's low forward voltage may outweigh the disadvantages of its high leakage current.

Current-Sense Resistor

The current-sense resistor limits the peak switch current to $210mV/R_{SENSE}$, where R_{SENSE} is the value of the current-sense resistor, and 210mV is the current-sense comparator threshold (see *Current-Limit Trip Level* in the *Electrical Characteristics*).

To maximize efficiency and reduce the size and cost of external components, minimize the peak current. However, since the output current is a function of the peak current, do not set the limit too low. See Figures 6–9 to determine the sense resistor, as well as the peak current, for the required load current.

-5V/-12V/-15V or Adjustable, High-Efficiency, Low I_Q Inverting DC-to-DC Controllers

MAX774/MAX775/MAX776

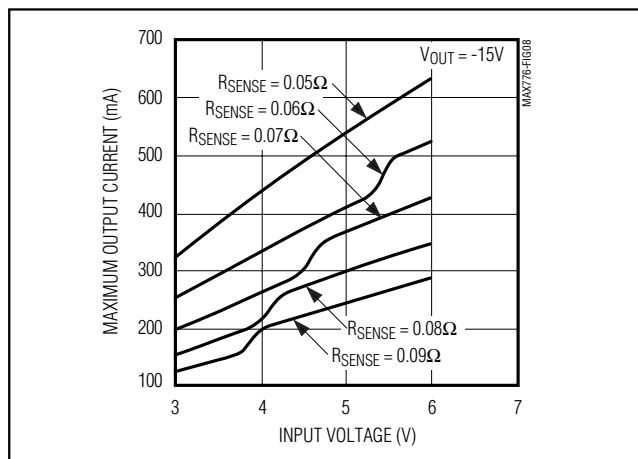

Figure 8. MAX776 Maximum Output Current vs. Input Voltage ($V_{OUT} = -15V$)

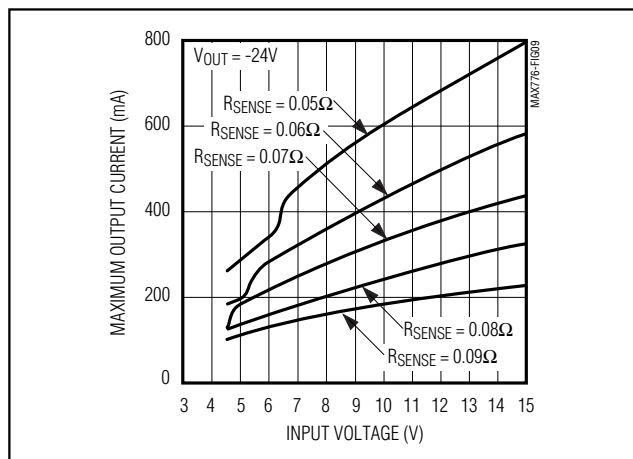

Figure 9. MAX774/MAX775/MAX776 Maximum Output Current vs. Input Voltage ($V_{OUT} = -24V$)

To choose the proper current-sense resistor, simply follow the two-step procedure outlined below:

- 1) Determine:
 - Input voltage range, V_+
 - Maximum (absolute) output voltage, V_{OUT}
 - Maximum output current, I_{LOAD}

For example, let V_+ range from 4V to 6V, and choose $V_{OUT} = -24V$ and $I_{OUT} = 150mA$.

- 2) Next, referring to Figure 9, find the curve with the lowest current limit whose output current (with the lowest input voltage) meets your requirements.

In our example, a curve where I_{OUT} is $>150mA$ with a 4V input and a -24V output is optimal.

The $R_{SENSE} = 80m\Omega$ (Figure 9) shows only approximately 125mA of output current with a 4V input, so we look next at the $R_{SENSE} = 70m\Omega$ line. It shows $I_{OUT} >150mA$ for $V_+ = 4V$ and $V_{OUT} = -24V$. The current limit will be $0.210V / 0.070\Omega = 3A$. These curves take into account worst-case inductor ($\pm 10\%$) and current-sense trip levels, but not sense-resistor tolerance. The switch on resistance is $70m\Omega$.

Standard wire-wound and metal-film resistors have an inductance high enough to degrade performance. Metal-film resistors are usually deposited on a ceramic rod in a spiral, making their inductances relatively high. Surface-mount (or chip) resistors have very little inductance and are well suited for use as current-sense

resistors. To use through-hole resistors, IRC has a wire resistor that is simply a band of metal shaped as a “U” so that inductance is less than 10nH (an order of magnitude less than metal-film resistors). These are available in resistance values between $5m\Omega$ and 0.1Ω .

External Switching Transistor

The MAX774/MAX775/MAX776 are capable of driving P-channel enhancement-mode MOSFET transistors only. The choice of power transistor is dictated by input and output voltage, peak current rating, on-resistance, gate-source threshold, and gate capacitance. The drain-to-source rating must be greater than the $V_+ - V_{OUT}$ input-to-output voltage differential. The gate-to-source rating must be greater than V_+ (the source voltage) plus the absolute value of the most negative swing of EXT. For bootstrapped operation, the most negative swing of EXT is V_{OUT} . In nonbootstrapped operation, this may be ground or some other negative voltage. Gate capacitance is not normally a limiting factor, but values should be less than 1nF for best efficiency. For maximum efficiency, the MOSFET should have a very-low on-resistance at the peak current and be capable of handling that current. The transistor chosen for the typical operating circuit has a 30V drain-source voltage limit and a 0.07Ω drain-source on-resistance at $V_{GS} = -10V$.

Table 1 lists suppliers of switching transistors suitable for use with the MAX774/MAX775/MAX776.

-5V/-12V/-15V or Adjustable, High-Efficiency, Low I_Q Inverting DC-to-DC Controllers

Table 1. Component Suppliers

SUPPLIER	PHONE	FAX
INDUCTORS		
Coiltronics	(407) 241-7876	(407) 241-9339
Gowanda	(716) 532-2234	(716) 532-2702
Sumida Japan	81-3-3607-5111	81-3-3607-5144
Sumida USA	(708) 956-0666	(708) 956-0702
CAPACITORS		
Kemet	(803) 963-6300	(803) 963-6322
Matsuo	(714) 969-2491	(714) 960-6492
Nichicon	(708) 843-7500	(708) 843-2798
Sanyo Japan	81-7-2070-6306	81-7-2070-1174
Sanyo USA	(619) 661-6835	(619) 661-1055
Sprague	(603) 224-1961	(603) 224-1430
United Chemi-Con	(714) 255-9500	(714) 255-9400
DIODES		
Motorola	(800) 521-6274	(602) 952-4190
Nihon USA	81-3-3494-7411	81-3-3494-7414
Nihon Japan	(805) 867-2555	(805) 867-2556
POWER MOSFETS		
Harris	(407) 724-3729	(407) 724-3937
International Rectifier	(310) 322-3331	(310) 322-3332
Siliconix	(408) 988-8000	(408) 970-3950
CURRENT-SENSE RESISTORS		
IRC	(704) 264-8861	(704) 264-8866

Capacitors

Choose the output capacitor (C4 of Figures 2, 3, and 4) to be consistent with size, ripple, and output voltage requirements. Place capacitors in parallel if the size desired is unobtainable. This will not only increase the capacitance, but also decrease the capacitor's ESR (a major contributor of ripple). A 330 μ F tantalum output filter capacitor with 0.07 Ω ESR typically maintains 120mV_{P-P}

output ripple when generating -5V at 1A from a 5V input. Smaller capacitors are acceptable for lighter loads or in applications that can tolerate higher output ripple.

The value of C4 is chosen such that it acquires as small a charge as possible during the switch on-time. The amount of ripple as a function of capacitance is give by:

$$\Delta V_{P-P} = \frac{V_{OUT} \times I_{OUT} \times ESR}{V_{IN}} + \frac{I_{OUT} \times t_{OFF(min)}}{C}$$

When evaluating this equation, be sure to use the capacitance value at the switching frequency. At 200kHz, the 330 μ F tantalum capacitor of Figures 2, 3, or 4 may degrade by a factor of ten, which will significantly alter the ripple voltage calculation.

The ESR of both the bypass and filter capacitors also affects efficiency. Best performance is obtained by doubling up on the filter capacitors or using low-ESR capacitors. Capacitors must have a ripple current rating equal to the peak current.

The smallest low-ESR SMT capacitors currently available are the Sprague 595D series. Sanyo OS-CON organic semiconductor through-hole capacitors also exhibit low ESR and are especially effective at low temperatures. Table 1 lists the phone numbers of these and other manufacturers.

PC Layout and Grounding

Due to high current levels and fast switching waveforms, proper PC board layout is essential. Use a star ground configuration; connect the ground lead of the input bypass capacitor, the output capacitor, the inductor, and the GND pin of the MAX774/MAX775/MAX776 at a common point very close to the device. Additionally, input capacitor C2 (Figures 3 and 4) should be placed extremely close to the device.

If an external resistor divider is used (Figures 3 and 4), the trace from FB to the resistors must be extremely short.

-5V/-12V/-15V or Adjustable, High-Efficiency, Low I_Q Inverting DC-to-DC Controllers

Ordering Information (continued)

PART	TEMP RANGE	PIN-PACKAGE
MAX775CPA	0°C to +70°C	8 Plastic DIP
MAX775CSA	0°C to +70°C	8 SO
MAX775C/D	0°C to +70°C	Dice*
MAX775EPA	-40°C to +85°C	8 Plastic DIP
MAX775ESA	-40°C to +85°C	8 SO
MAX775MJA	-55°C to +125°C	8 CERDIP
MAX776CPA	0°C to +70°C	8 Plastic DIP
MAX776CSA	0°C to +70°C	8 SO
MAX776C/D	0°C to +70°C	Dice*
MAX776EPA	-40°C to +85°C	8 Plastic DIP
MAX776ESA	-40°C to +85°C	8 SO
MAX776MJA	-55°C to +125°C	8 CERDIP

*Contact factory for dice specifications.

Chip Topography

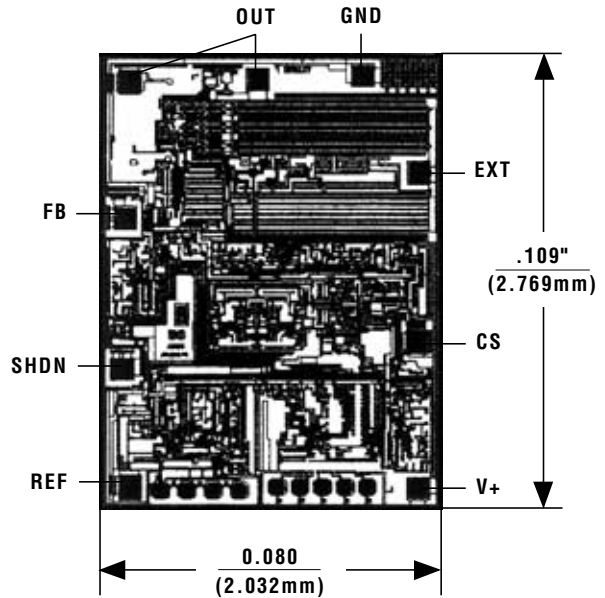

TRANSISTOR COUNT: 442;
SUBSTRATE CONNECTED TO V+.

MAX774/MAX775/MAX776

Package Information

(The package drawing(s) in this data sheet may not reflect the most current specifications. For the latest package outline information, go to www.maxim-ic.com/packages.)

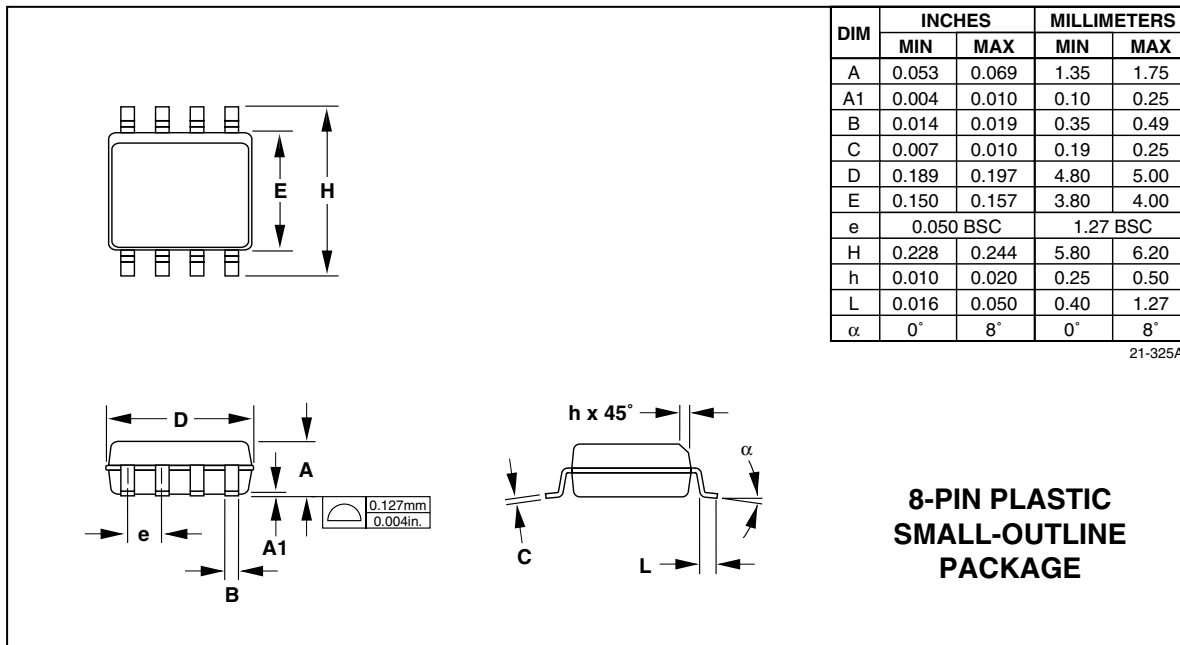

-5V/-12V/-15V or Adjustable, High-Efficiency, Low I_Q Inverting DC-to-DC Controllers

Package Information (continued)

(The package drawing(s) in this data sheet may not reflect the most current specifications. For the latest package outline information, go to www.maxim-ic.com/packages.)

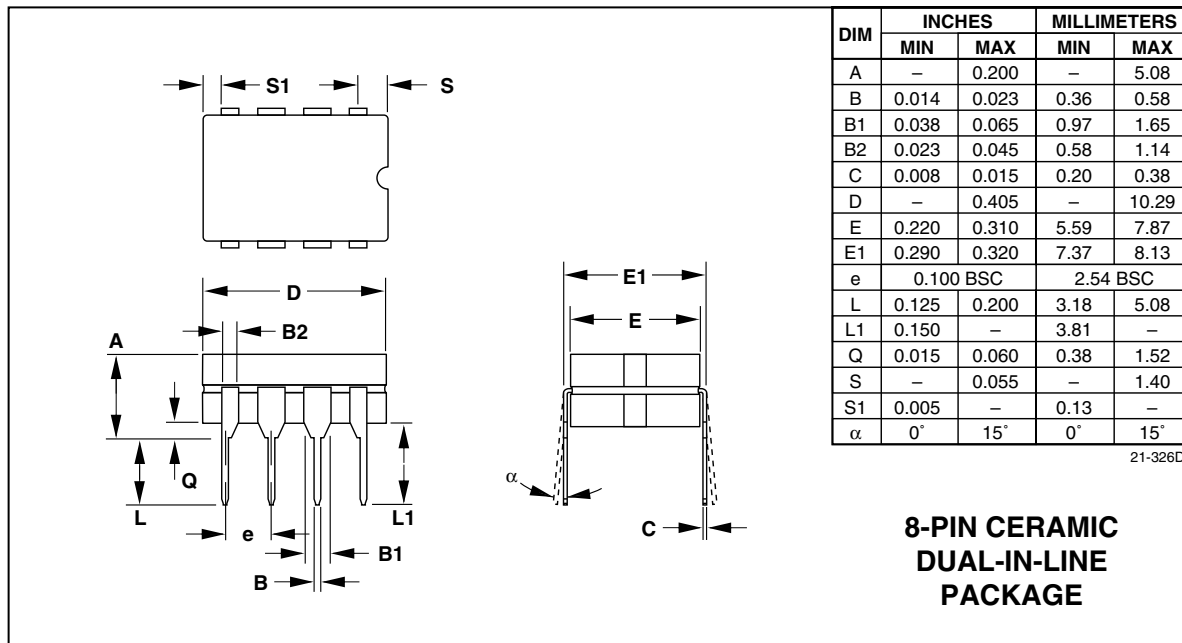
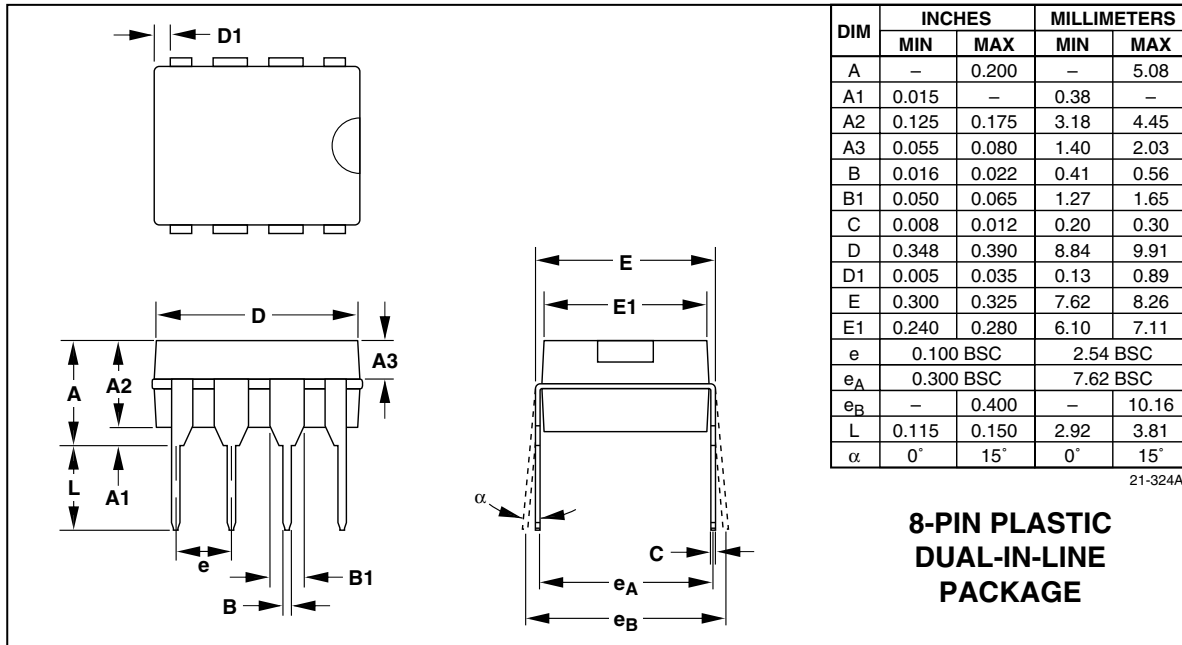

Maxim cannot assume responsibility for use of any circuitry other than circuitry entirely embodied in a Maxim product. No circuit patent licenses are implied. Maxim reserves the right to change the circuitry and specifications without notice at any time.

16 _____ **Maxim Integrated Products, 120 San Gabriel Drive, Sunnyvale, CA 94086 (408) 737-7600**

Looking for pricing, stock, or lifecycle information?

Click below to explore more details on WIN SOURCE:

- ⊖ [View MAX776ESA+](#) on WIN SOURCE
- ⊖ [Maxim Integrated](#) Information

Optimize Your Supply Chain with WIN SOURCE Solutions

- ✓ Global Sourcing Solution
- ✓ Obsolete Management
- ✓ Cost Control Management
- ✓ Shortage Management
- ✓ Alternative Solution
- ✓ Excess Inventory Management