



**THE DATASHEET OF
TPS7A8101DRBT**



TPS7A8101 Low-Noise, Wide-Bandwidth, High PSRR, Low-Dropout 1-A Linear Regulator

1 Features

- Low-Dropout 1-A Regulator with Enable
- Adjustable Output Voltage: 0.8 V to 6 V
- Wide-Bandwidth High PSRR:
 - 80 dB at 1 kHz
 - 60 dB at 100 kHz
 - 54 dB at 1 MHz
- Low Noise: 23.5 μV_{RMS} typical (100 Hz to 100 kHz)
- Stable with a 4.7- μF Capacitance
- Excellent Load and Line Transient Response
- 3% Overall Accuracy (Over Load, Line, Temperature)
- Overcurrent and Overtemperature Protection
- Very Low Dropout: 170 mV Typical at 1 A
- Package: 3-mm \times 3-mm SON-8

2 Applications

- Telecom Infrastructure
- Audio
- High-Speed I/F (PLL and VCO)

3 Description

The TPS7A8101 low-dropout linear regulator (LDO) offers very good performance in noise and power-supply rejection ratio (PSRR) at the output. This LDO uses an advanced BiCMOS process and a PMOSFET pass device to achieve very low noise, excellent transient response, and excellent PSRR performance.

The TPS7A8101 device is stable with a 4.7- μF ceramic output capacitor, and uses a precision voltage reference and feedback loop to achieve a worst-case accuracy of 3% over all load, line, process, and temperature variations.

This device is fully specified over the temperature range of $T_J = -40^\circ\text{C}$ to 125°C and is offered in a 3-mm \times 3-mm, SON-8 package with a thermal pad.

Device Information⁽¹⁾

PART NUMBER	PACKAGE	BODY SIZE (NOM)
TPS7A8101	SON (8)	3.00 mm \times 3.00 mm

(1) For all available packages, see the orderable addendum at the end of the data sheet.

Typical Application Circuit

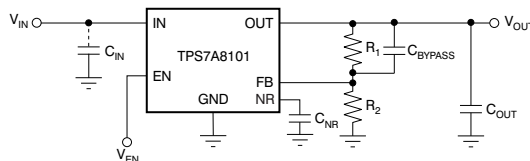

Table of Contents

1 Features	1	8.1 Application Information.....	13
2 Applications	1	8.2 Typical Application	13
3 Description	1	9 Power Supply Recommendations	15
4 Revision History	2	10 Layout	16
5 Pin Configuration and Functions	3	10.1 Layout Guidelines	16
6 Specifications	4	10.2 Layout Example	16
6.1 Absolute Maximum Ratings	4	10.3 Thermal Protection.....	16
6.2 ESD Ratings.....	4	10.4 Power Dissipation	17
6.3 Recommended Operating Conditions.....	4	10.5 Estimating Junction Temperature	17
6.4 Thermal Information	4	11 Device and Documentation Support	19
6.5 Electrical Characteristics.....	5	11.1 Device Support.....	19
6.6 Typical Characteristics.....	6	11.2 Documentation Support	19
7 Detailed Description	11	11.3 Community Resources.....	19
7.1 Overview	11	11.4 Trademarks	19
7.2 Functional Block Diagram	11	11.5 Electrostatic Discharge Caution.....	19
7.3 Feature Description.....	11	11.6 Glossary	19
7.4 Device Functional Modes.....	12	12 Mechanical, Packaging, and Orderable Information	19
8 Application and Implementation	13		

4 Revision History

NOTE: Page numbers for previous revisions may differ from page numbers in the current version.

Changes from Revision A (April 2012) to Revision B	Page
<ul style="list-style-type: none"> Added <i>ESD Ratings</i> table, <i>Feature Description</i> section, <i>Device Functional Modes</i>, <i>Application and Implementation</i> section, <i>Power Supply Recommendations</i> section, <i>Layout</i> section, <i>Device and Documentation Support</i> section, and <i>Mechanical, Packaging, and Orderable Information</i> section 	1

Changes from Original (December 2011) to Revision A	Page
<ul style="list-style-type: none"> Added new footnote 2 to Thermal Information table, changed footnote 3 	4

5 Pin Configuration and Functions

DRB PACKAGE
8-Pin SON With Exposed Thermal Pad
Top View

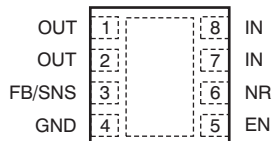

Pin Functions

PIN		I/O	DESCRIPTION
NAME	NO.		
EN	5	I	Driving this pin high turns on the regulator. Driving this pin low puts the regulator into shutdown mode. Refer to the Shutdown section for more details. EN must not be left floating and can be connected to IN if not used.
FB	3	I	This pin is the input to the control-loop error amplifier and is used to set the output voltage of the device.
GND	4, pad	—	Ground
IN	7	I	Unregulated input supply
	8		
NR	6	—	Connect an external capacitor between this pin and ground to reduce output noise to very low levels. The capacitor also slows down the V_{OUT} ramp (RC softstart).
OUT	1	O	Regulator output. A 4.7- μ F or larger capacitor of any type is required for stability.
	2		

6 Specifications

6.1 Absolute Maximum Ratings

Over operating free-air temperature range (unless otherwise noted).⁽¹⁾

		MIN	MAX	UNIT
Voltage	IN	-0.3	7	V
	FB, NR	-0.3	3.6	
	EN	-0.3	$V_{IN} + 0.3^{(2)}$	
	OUT	-0.3	7	
Current	OUT	Internally Limited		A
Temperature	Operating virtual junction, T_J	-55	150	°C
	Storage, T_{stg}	-55	150	°C

- (1) Stresses beyond those listed under *Absolute Maximum Ratings* may cause permanent damage to the device. These are stress ratings only, and functional operation of the device at these or any other conditions beyond those indicated is not implied. Exposure to absolute-maximum-rated conditions for extended periods may affect device reliability.
- (2) V_{EN} absolute maximum rating is $V_{IN} + 0.3$ V or +7 V, whichever is smaller.

6.2 ESD Ratings

		VALUE	UNIT
$V_{(ESD)}$ Electrostatic discharge	Human body model (HBM), per ANSI/ESDA/JEDEC JS-001, all pins ⁽¹⁾	±2000	V
	Charged device model (CDM), per JEDEC specification JESD22-C101, all pins ⁽²⁾	±500	

- (1) JEDEC document JEP155 states that 500-V HBM allows safe manufacturing with a standard ESD control process.
- (2) JEDEC document JEP157 states that 250-V CDM allows safe manufacturing with a standard ESD control process.

6.3 Recommended Operating Conditions

Over operating free-air temperature range (unless otherwise noted)

		MIN	MAX	UNIT
V_I	Input voltage	2.2	6.5	V
I_O	Output current	0	1	A
T_A	Operating free air temperature	-40	125	°C

6.4 Thermal Information

THERMAL METRIC ⁽¹⁾		TPS7A8101	UNIT
		DRV (SON)	
		8 PINS	
$R_{\theta JA}$	Junction-to-ambient thermal resistance	47.8	°C/W
$R_{\theta JC(top)}$	Junction-to-case (top) thermal resistance	53.9	°C/W
$R_{\theta JB}$	Junction-to-board thermal resistance	23.4	°C/W
Ψ_{JT}	Junction-to-top characterization parameter	1	°C/W
Ψ_{JB}	Junction-to-board characterization parameter	23.5	°C/W
$R_{\theta JC(bot)}$	Junction-to-case (bottom) thermal resistance	7.4	°C/W

- (1) For more information about traditional and new thermal metrics, see the *Semiconductor and IC Package Thermal Metrics* application report, [SPRA953](#).

6.5 Electrical Characteristics

Over the operating temperature range of $T_J = -40^\circ\text{C}$ to $+125^\circ\text{C}$, $V_{IN} = V_{OUT(TYP)} + 0.5\text{ V}$ or 2.2 V (whichever is greater), $I_{OUT} = 1\text{ mA}$, $V_{EN} = 2.2\text{ V}$, $C_{OUT} = 4.7\text{ }\mu\text{F}$, $C_{NR} = 0.01\text{ }\mu\text{F}$, and $C_{BYPASS} = 0\text{ }\mu\text{F}$, unless otherwise noted. TPS7A8101 is tested at $V_{OUT} = 0.8\text{ V}$ and $V_{OUT} = 6\text{ V}$. Typical values are at $T_J = 25^\circ\text{C}$.

PARAMETER		TEST CONDITIONS	MIN	TYP	MAX	UNIT
V_{IN}	Input voltage range ⁽¹⁾		2.2		6.5	V
V_{NR}	Internal reference		0.79	0.8	0.81	V
V_{OUT}	Output voltage range		0.8		6	V
	Output accuracy ⁽²⁾	$V_{OUT} + 0.5\text{ V} \leq V_{IN} \leq 6\text{ V}$, $V_{IN} \geq 2.5\text{ V}$, $100\text{ mA} \leq I_{OUT} \leq 500\text{ mA}$, $0^\circ\text{C} \leq T_J \leq 85^\circ\text{C}$	-2%		2%	
		$V_{OUT} + 0.5\text{ V} \leq V_{IN} \leq 6.5\text{ V}$, $V_{IN} \geq 2.2\text{ V}$, $100\text{ mA} \leq I_{OUT} \leq 1\text{ A}$	-3%	$\pm 0.3\%$	3%	
$\Delta V_{O(\Delta VI)}$	Line regulation	$V_{OUT(NOM)} + 0.5\text{ V} \leq V_{IN} \leq 6.5\text{ V}$, $V_{IN} \geq 2.2\text{ V}$, $I_{OUT} = 100\text{ mA}$		150		$\mu\text{V/V}$
$\Delta V_{O(\Delta IL)}$	Load regulation	$100\text{ mA} \leq I_{OUT} \leq 1\text{ A}$		2		$\mu\text{V/mA}$
V_{DO}	Dropout voltage ⁽³⁾	$V_{OUT} + 0.5\text{ V} \leq V_{IN} \leq 6.5\text{ V}$, $V_{IN} \geq 2.2\text{ V}$, $I_{OUT} = 500\text{ mA}$, $V_{FB} = \text{GND}$ or $V_{SNS} = \text{GND}$			250	mV
		$V_{OUT} + 0.5\text{ V} \leq V_{IN} \leq 6.5\text{ V}$, $V_{IN} \geq 2.5\text{ V}$, $I_{OUT} = 750\text{ mA}$, $V_{FB} = \text{GND}$ or $V_{SNS} = \text{GND}$			350	
		$V_{OUT} + 0.5\text{ V} \leq V_{IN} \leq 6.5\text{ V}$, $V_{IN} \geq 2.5\text{ V}$, $I_{OUT} = 1\text{ A}$, $V_{FB} = \text{GND}$ or $V_{SNS} = \text{GND}$			500	
I_{LIM}	Output current limit	$V_{OUT} = 0.85 \times V_{OUT(NOM)}$, $V_{IN} \geq 3.3\text{ V}$	1100	1400	2000	mA
I_{GND}	Ground pin current	$I_{OUT} = 1\text{ mA}$		60	100	μA
		$I_{OUT} = 1\text{ A}$			350	
I_{SHDN}	Shutdown current (I_{GND})	$V_{EN} \leq 0.4\text{ V}$, $V_{IN} \geq 2.2\text{ V}$, $R_L = 1\text{ k}\Omega$, $0^\circ\text{C} \leq T_J \leq 85^\circ\text{C}$		0.2	2	μA
I_{FB}	Feedback pin current	$V_{IN} = 6.5\text{ V}$, $V_{FB} = 0.8\text{ V}$		0.02	1	μA
PSRR	Power-supply rejection ratio	$V_{IN} = 4.3\text{ V}$, $V_{OUT} = 3.3\text{ V}$, $I_{OUT} = 750\text{ mA}$	$f = 100\text{ Hz}$		80	dB
			$f = 1\text{ kHz}$		82	
			$f = 10\text{ kHz}$		78	
			$f = 100\text{ kHz}$		60	
			$f = 1\text{ MHz}$		54	
V_n	Output noise voltage	$BW = 100\text{ Hz to } 100\text{ kHz}$, $V_{IN} = 3.8\text{ V}$, $V_{OUT} = 3.3\text{ V}$, $I_{OUT} = 100\text{ mA}$, $C_{NR} = C_{BYPASS} = 470\text{ nF}$		23.5		μV_{RMS}
$V_{EN(HI)}$	Enable high (enabled)	$2.2\text{ V} \leq V_{IN} \leq 3.6\text{ V}$, $R_L = 1\text{ k}\Omega$	1.2			V
		$3.6\text{ V} < V_{IN} \leq 6.5\text{ V}$, $R_L = 1\text{ k}\Omega$	1.35			
$V_{EN(LO)}$	Enable low (shutdown)	$R_L = 1\text{ k}\Omega$	0		0.4	V
$I_{EN(HI)}$	Enable pin current, enabled	$V_{IN} = V_{EN} = 6.5\text{ V}$		0.02	1	μA
t_{STR}	Start-up time	$V_{OUT(NOM)} = 3.3\text{ V}$, $V_{OUT} = 0\%$ to $90\% V_{OUT(NOM)}$, $R_L = 3.3\text{ k}\Omega$, $C_{OUT} = 10\text{ }\mu\text{F}$, $C_{NR} = 470\text{ nF}$		80		ms
UVLO	Undervoltage lockout	V_{IN} rising, $R_L = 1\text{ k}\Omega$	1.86	2	2.10	V
	Hysteresis	V_{IN} falling, $R_L = 1\text{ k}\Omega$		75		mV
T_{SD}	Thermal shutdown temperature	Shutdown, temperature increasing		160		$^\circ\text{C}$
		Reset, temperature decreasing		140		$^\circ\text{C}$
T_J	Operating junction temperature		-40		125	$^\circ\text{C}$

(1) Minimum $V_{IN} = V_{OUT} + V_{DO}$ or 2.2 V , whichever is greater.

(2) The TPS7A8101 does not include external resistor tolerances and it is not tested at this condition: $V_{OUT} = 0.8\text{ V}$, $4.5\text{ V} \leq V_{IN} \leq 6.5\text{ V}$, and $750\text{ mA} \leq I_{OUT} \leq 1\text{ A}$ because the power dissipation is greater than the maximum rating of the package.

(3) V_{DO} is not measured for fixed output voltage devices with $V_{OUT} < 1.7\text{ V}$ because minimum $V_{IN} = 2.2\text{ V}$.

6.6 Typical Characteristics

At $V_{O\text{nom}} = 3.3\text{ V}$, $V_I = V_{O\text{nom}} + 0.5\text{ V}$ or 2.2 V (whichever is greater), $I_O = 100\text{ mA}$, $V_{(EN)} = V_I$, $C_{(IN)} = 1\text{ }\mu\text{F}$, $C_{(OUT)} = 4.7\text{ }\mu\text{F}$, and $C_{(NR)} = 0.01\text{ }\mu\text{F}$; all temperature values refer to T_J , unless otherwise noted.

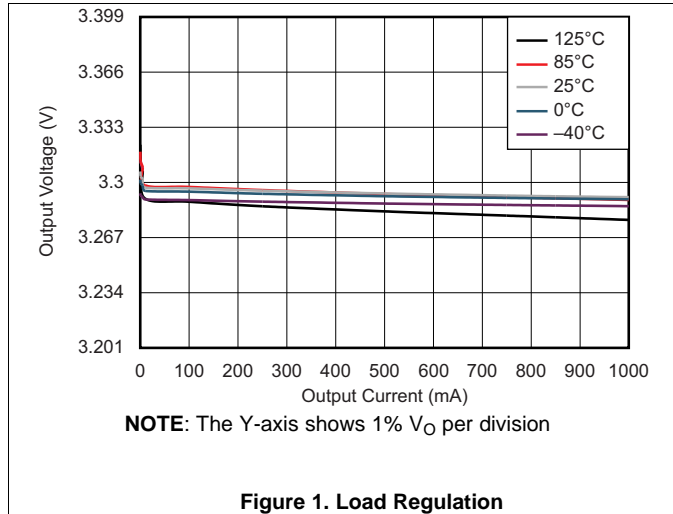

Figure 1. Load Regulation

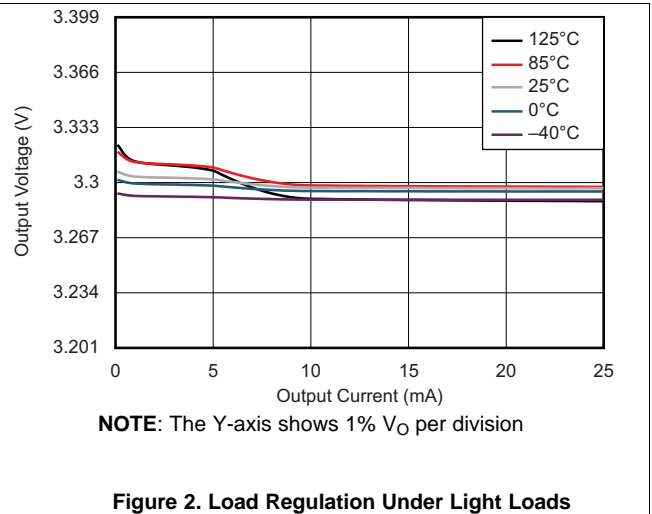

Figure 2. Load Regulation Under Light Loads

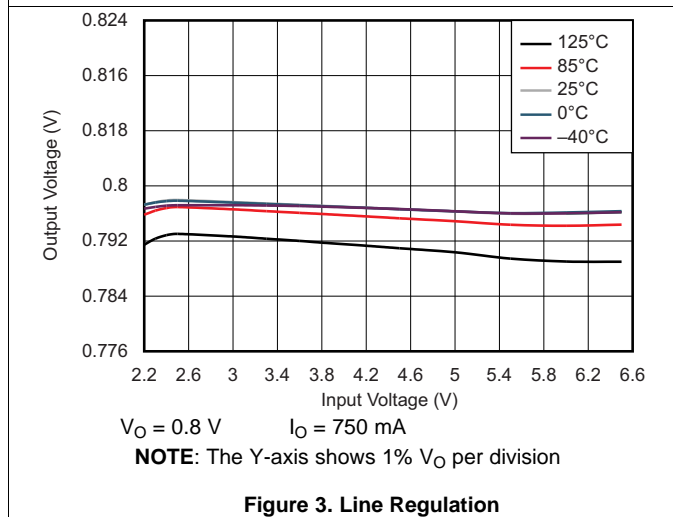

Figure 3. Line Regulation

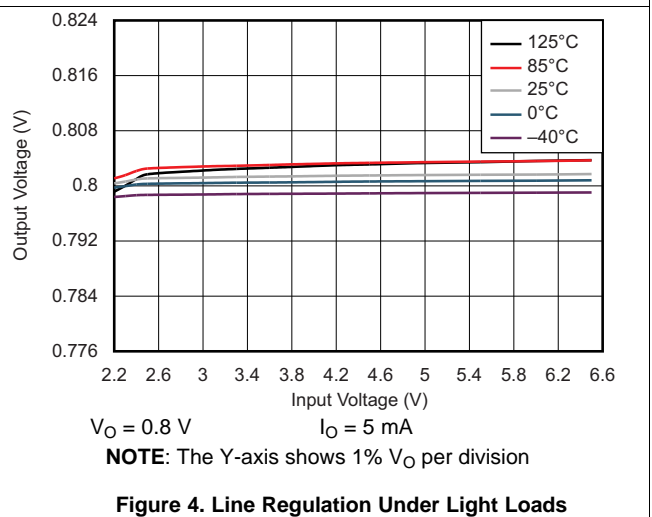

Figure 4. Line Regulation Under Light Loads

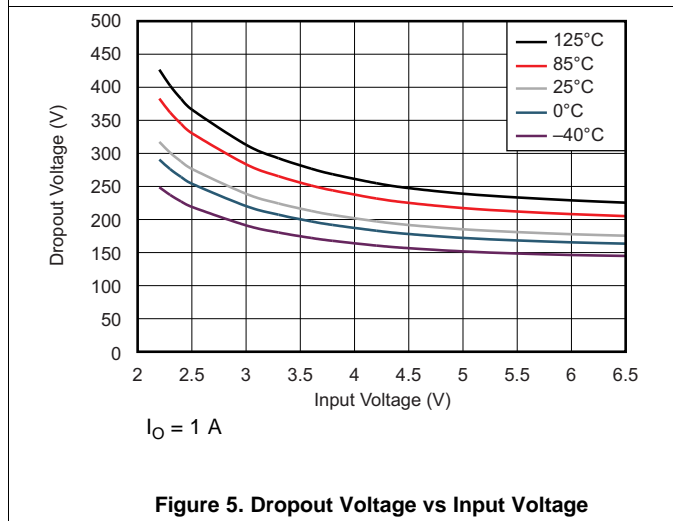

Figure 5. Dropout Voltage vs Input Voltage

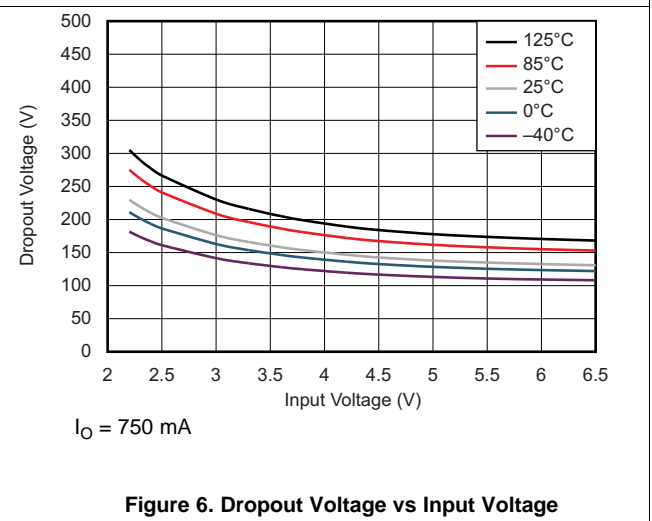

Figure 6. Dropout Voltage vs Input Voltage

Typical Characteristics (continued)

At $V_{Onom} = 3.3\text{ V}$, $V_I = V_{Onom} + 0.5\text{ V}$ or 2.2 V (whichever is greater), $I_O = 100\text{ mA}$, $V_{(EN)} = V_I$, $C_{(IN)} = 1\text{ }\mu\text{F}$, $C_{(OUT)} = 4.7\text{ }\mu\text{F}$, and $C_{(NR)} = 0.01\text{ }\mu\text{F}$; all temperature values refer to T_J , unless otherwise noted.

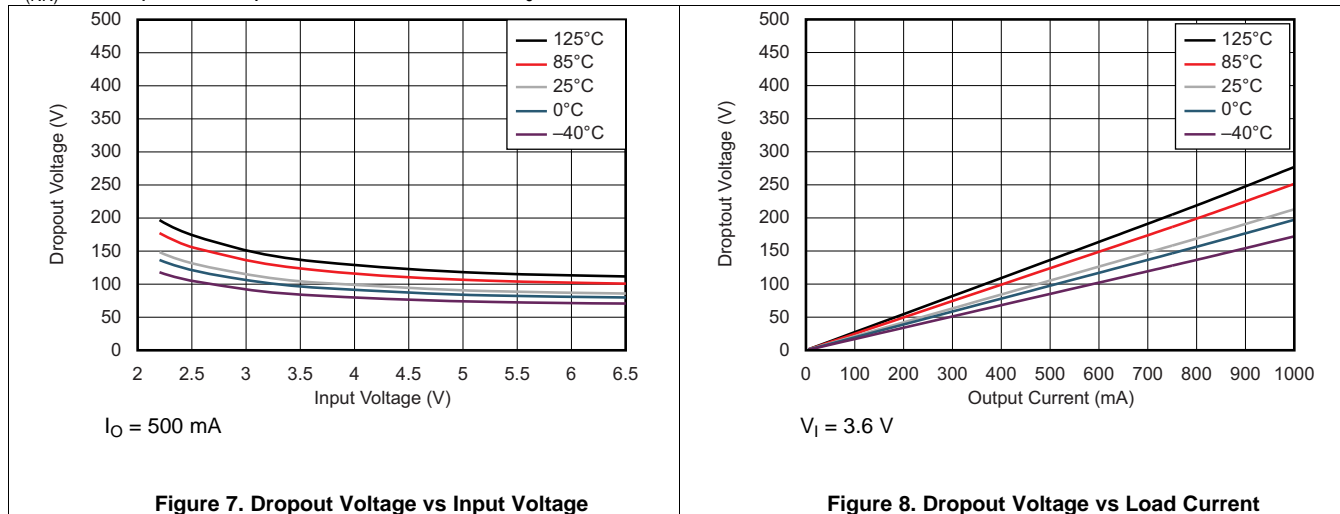

Figure 7. Dropout Voltage vs Input Voltage

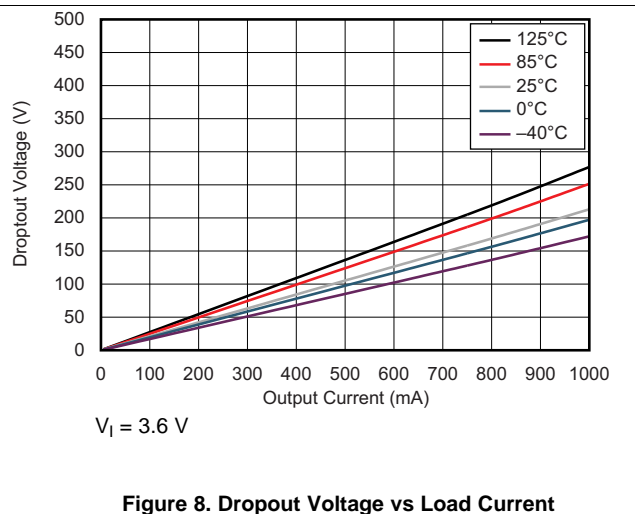

Figure 8. Dropout Voltage vs Load Current

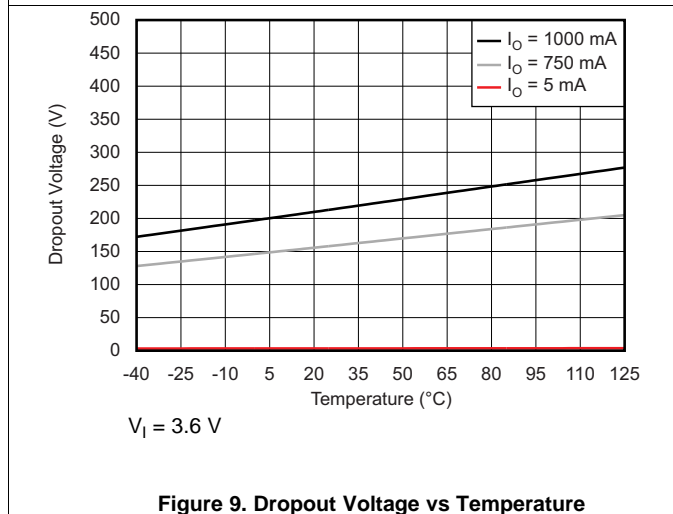

Figure 9. Dropout Voltage vs Temperature

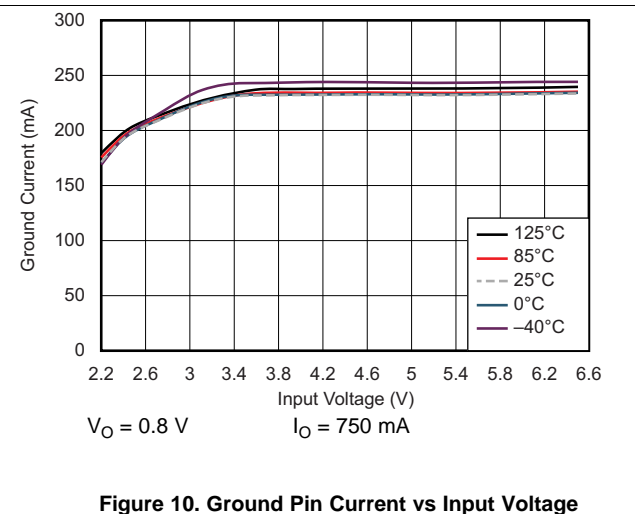

Figure 10. Ground Pin Current vs Input Voltage

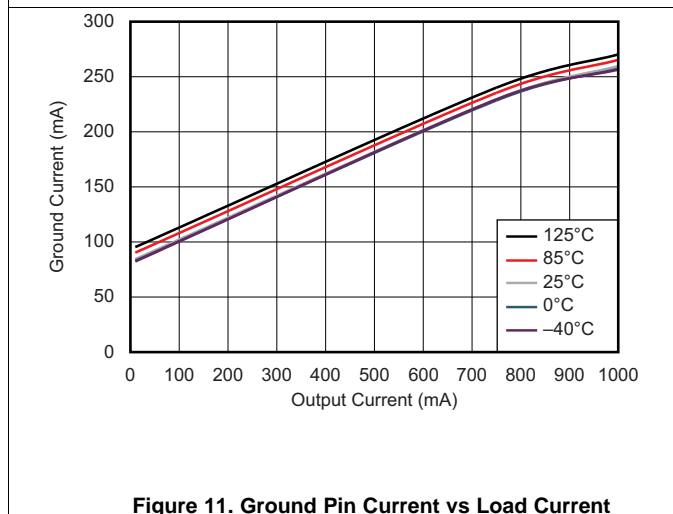

Figure 11. Ground Pin Current vs Load Current

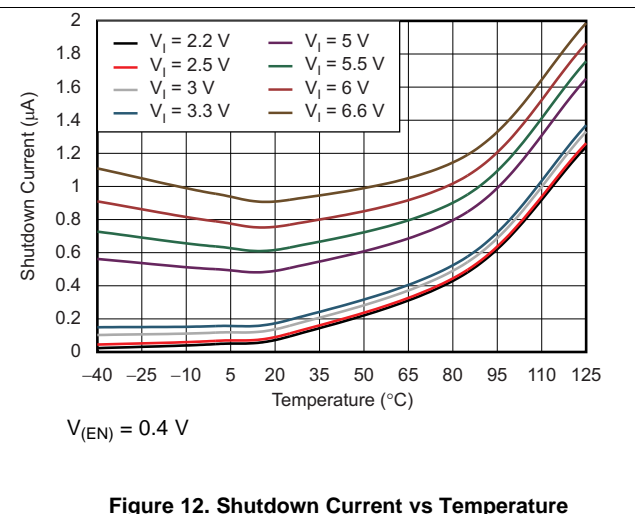

Figure 12. Shutdown Current vs Temperature

Typical Characteristics (continued)

At $V_{Onom} = 3.3\text{ V}$, $V_I = V_{Onom} + 0.5\text{ V}$ or 2.2 V (whichever is greater), $I_O = 100\text{ mA}$, $V_{(EN)} = V_I$, $C_{(IN)} = 1\text{ }\mu\text{F}$, $C_{(OUT)} = 4.7\text{ }\mu\text{F}$, and $C_{(NR)} = 0.01\text{ }\mu\text{F}$; all temperature values refer to T_J , unless otherwise noted.

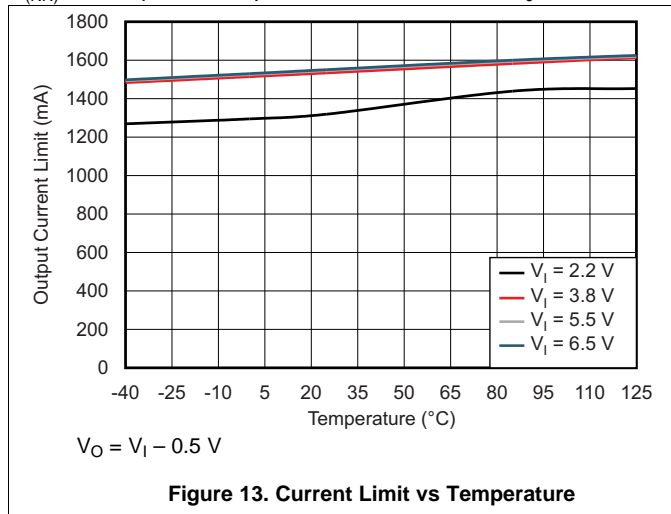

Figure 13. Current Limit vs Temperature

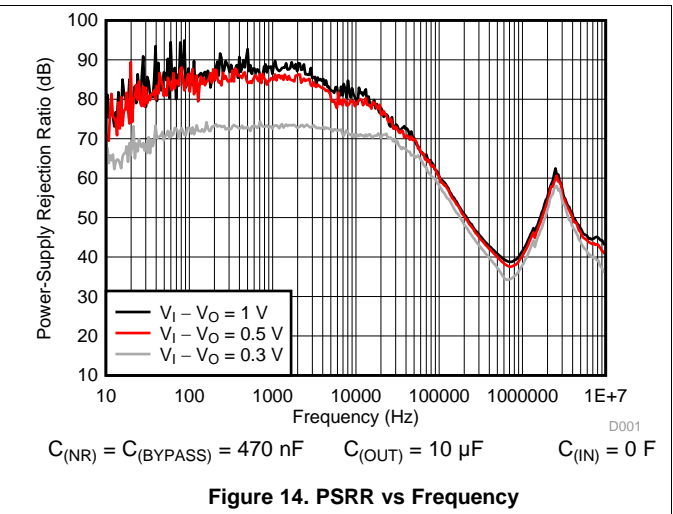

Figure 14. PSRR vs Frequency

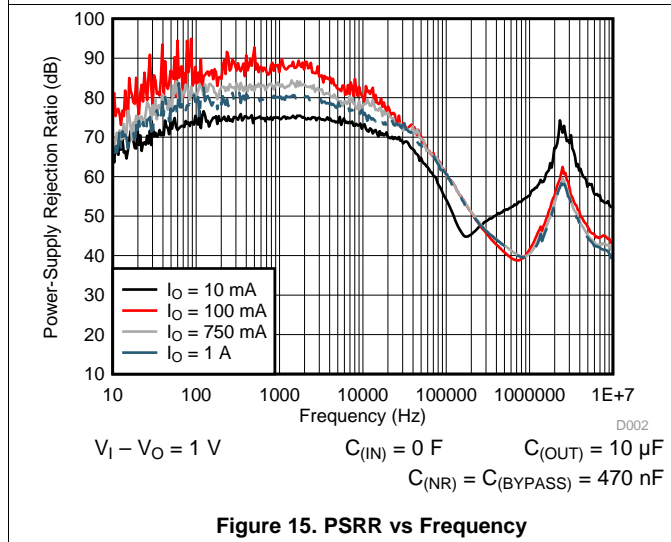

Figure 15. PSRR vs Frequency

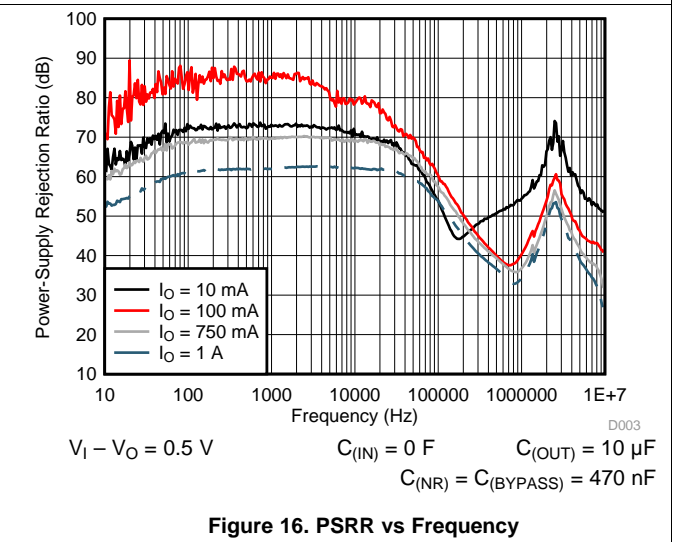

Figure 16. PSRR vs Frequency

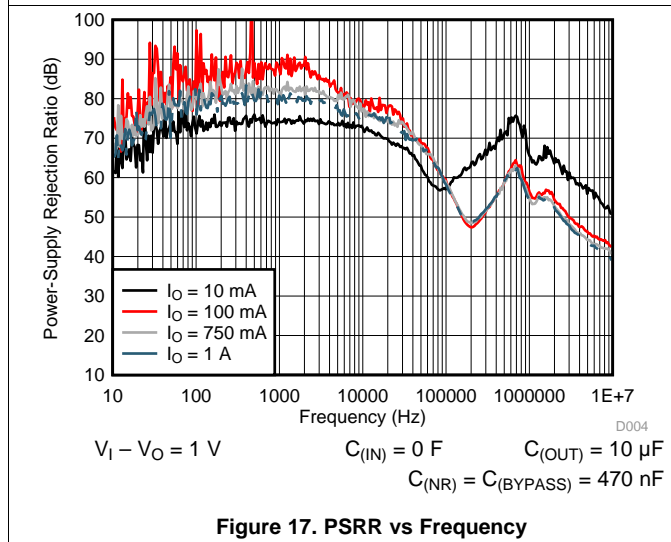

Figure 17. PSRR vs Frequency

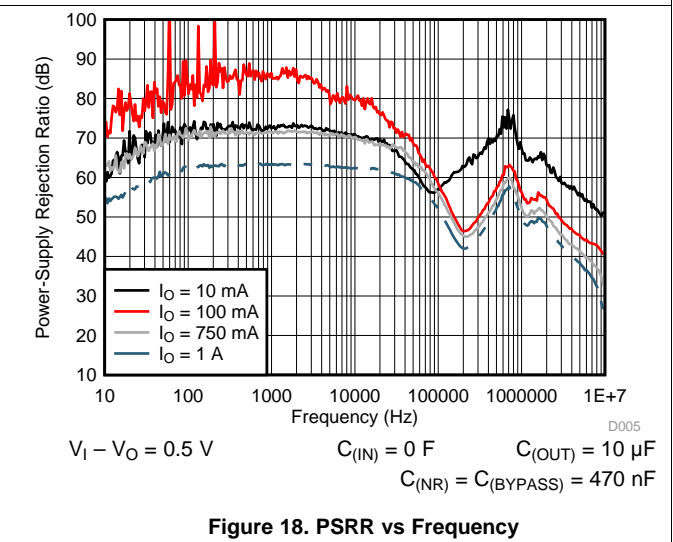

Figure 18. PSRR vs Frequency

Typical Characteristics (continued)

At $V_{Onom} = 3.3\text{ V}$, $V_I = V_{Onom} + 0.5\text{ V}$ or 2.2 V (whichever is greater), $I_O = 100\text{ mA}$, $V_{(EN)} = V_I$, $C_{(IN)} = 1\text{ }\mu\text{F}$, $C_{(OUT)} = 4.7\text{ }\mu\text{F}$, and $C_{(NR)} = 0.01\text{ }\mu\text{F}$; all temperature values refer to T_J , unless otherwise noted.

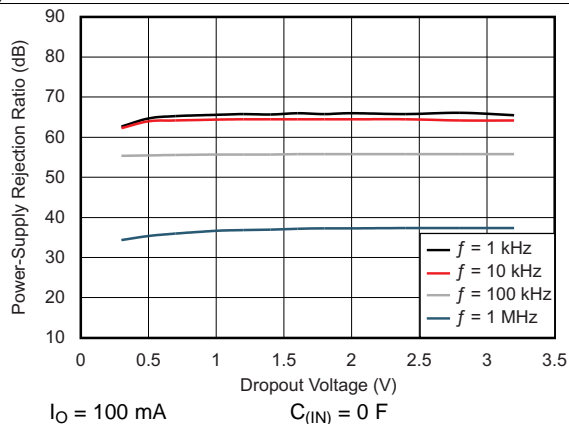

Figure 19. PSRR vs Dropout Voltage

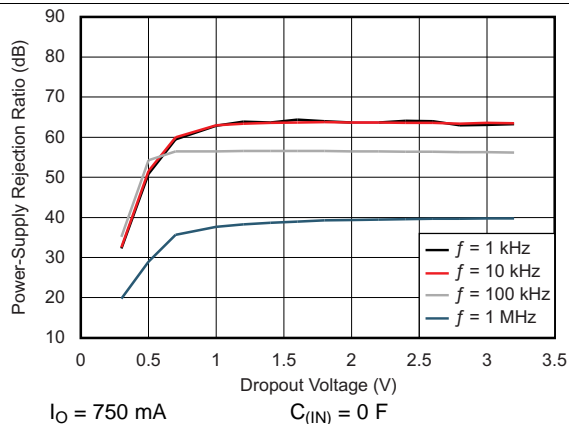
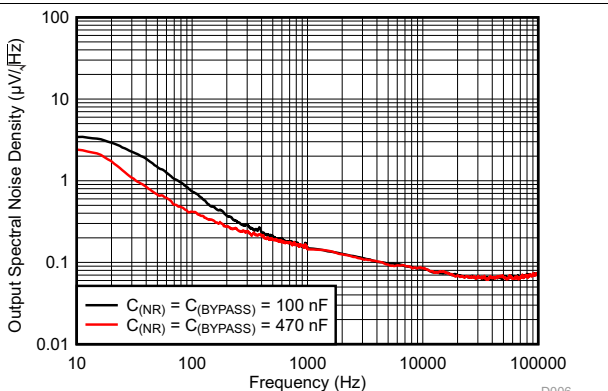
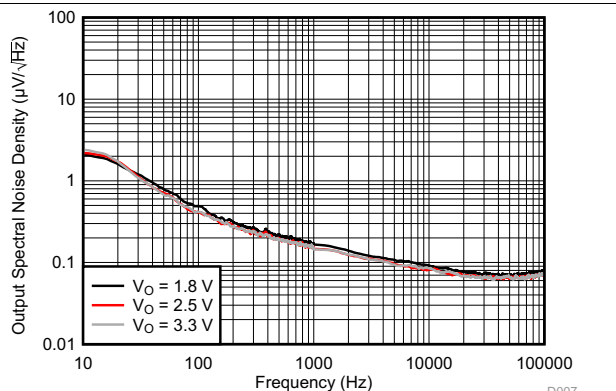

Figure 20. PSRR vs Dropout Voltage



$V_I - V_O = 0.5\text{ V}$ $C_{(OUT)} = 10\text{ }\mu\text{F}$ $C_{(IN)} = 10\text{ }\mu\text{F}$
 24.09 μV_{RMS} ($C_{(NR)} = C_{(BYPASS)} = 100\text{ nF}$)
 23.54 μV_{RMS} ($C_{(NR)} = C_{(BYPASS)} = 470\text{ nF}$)

Figure 21. Output Spectral Noise Density vs Frequency (RMS noise (100 Hz to 100 kHz))



25.89 μV_{RMS} ($V_O = 1.8\text{ V}$) $C_{(IN)} = 10\text{ }\mu\text{F}$ $V_I - V_O = 0.5\text{ V}$
 23.54 μV_{RMS} ($V_O = 2.5\text{ V}$) $C_{(NR)} = 470\text{ nF}$ $C_{(OUT)} = 10\text{ }\mu\text{F}$
 23.54 μV_{RMS} ($V_O = 3.3\text{ V}$) $C_{(BYPASS)} = 470\text{ nF}$

Figure 22. Output Spectral Noise Density vs Frequency (RMS noise (100 Hz to 100 kHz))

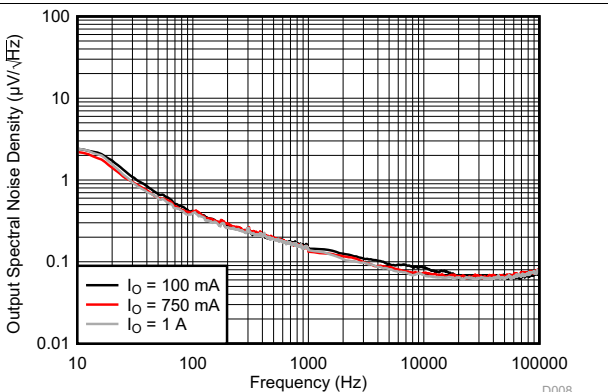

23.54 μV_{RMS} ($I_O = 100\text{ mA}$) $C_{(IN)} = 10\text{ }\mu\text{F}$ $V_I - V_O = 0.5\text{ V}$
 23.71 μV_{RMS} ($I_O = 750\text{ mA}$) $C_{(NR)} = 470\text{ nF}$ $C_{(OUT)} = 10\text{ }\mu\text{F}$
 22.78 μV_{RMS} ($I_O = 1\text{ A}$) $C_{(BYPASS)} = 470\text{ nF}$

Figure 23. Output Spectral Noise Density vs Frequency (RMS noise (100 Hz to 100 kHz))

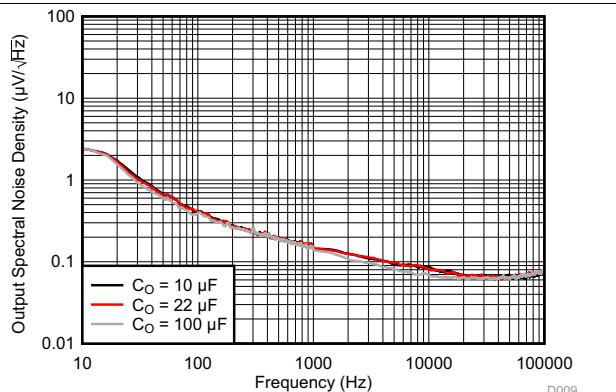

23.54 μV_{RMS} ($C_O = 10\text{ }\mu\text{F}$) $C_{(IN)} = 10\text{ }\mu\text{F}$ $V_I - V_O = 0.5\text{ V}$
 23.91 μV_{RMS} ($C_O = 22\text{ }\mu\text{F}$) $C_{(NR)} = 470\text{ nF}$ $C_{(OUT)} = 10\text{ }\mu\text{F}$
 22.78 μV_{RMS} ($C_O = 100\text{ }\mu\text{F}$) $C_{(BYPASS)} = 470\text{ nF}$

Figure 24. Output Spectral Noise Density vs Frequency (RMS noise (100 Hz to 100 kHz))

Typical Characteristics (continued)

At $V_{Onom} = 3.3\text{ V}$, $V_I = V_{Onom} + 0.5\text{ V}$ or 2.2 V (whichever is greater), $I_O = 100\text{ mA}$, $V_{(EN)} = V_I$, $C_{(IN)} = 1\text{ }\mu\text{F}$, $C_{(OUT)} = 4.7\text{ }\mu\text{F}$, and $C_{(NR)} = 0.01\text{ }\mu\text{F}$; all temperature values refer to T_J , unless otherwise noted.

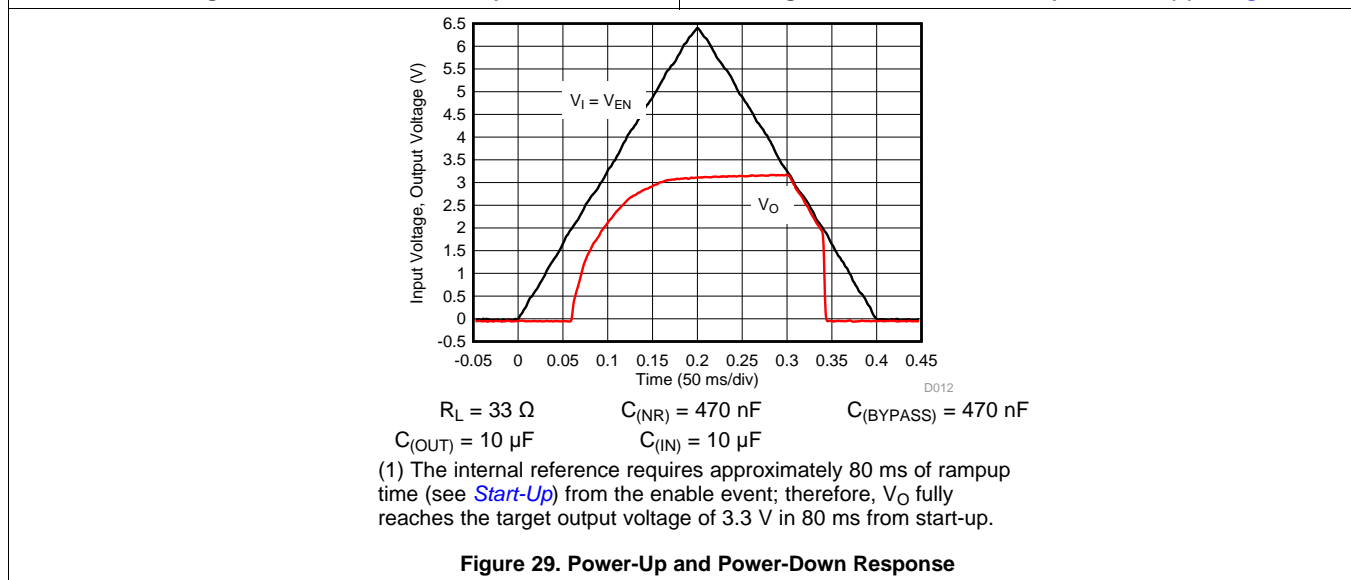
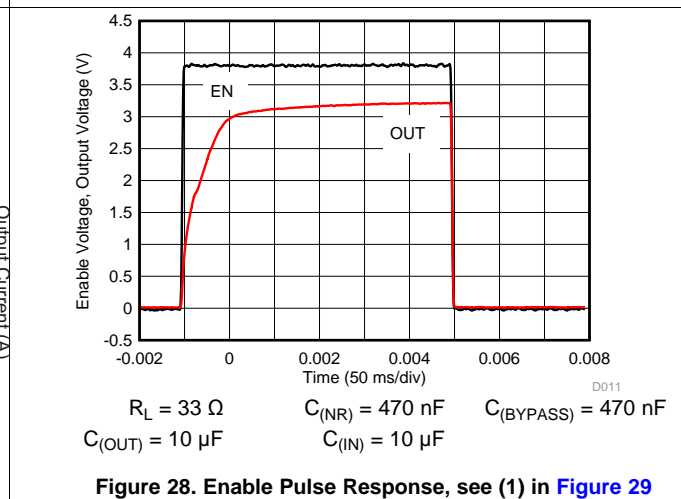
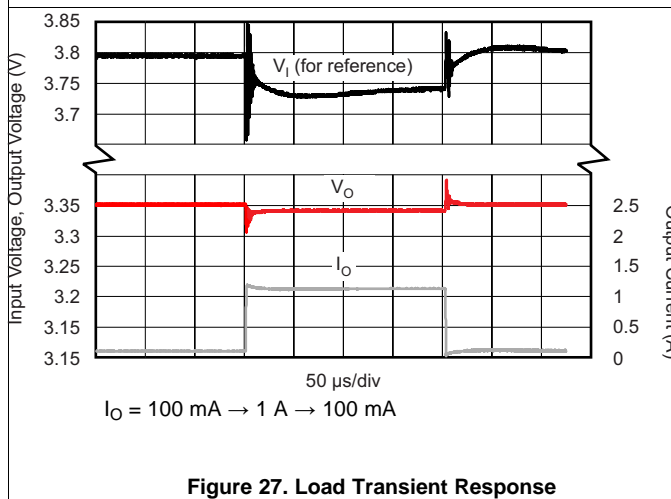
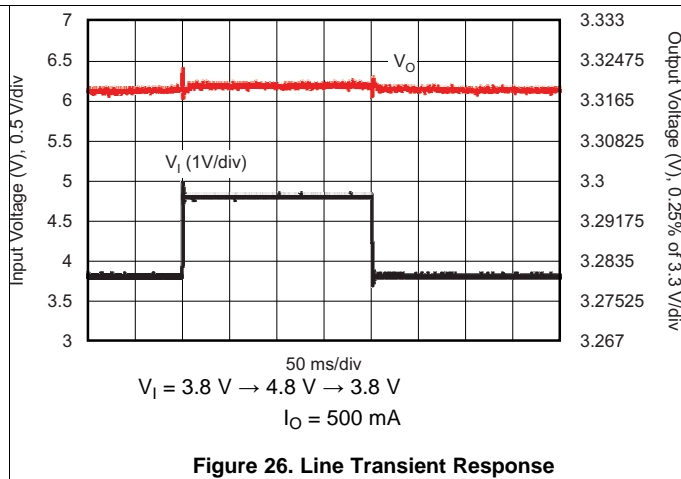
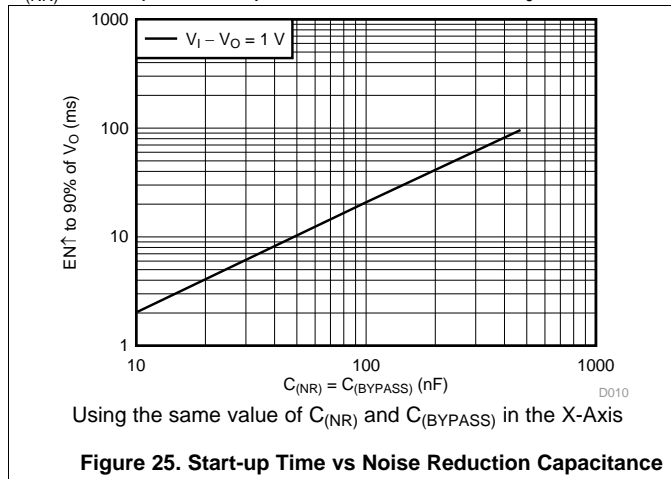

7 Detailed Description

7.1 Overview

The TPS7A8101 device belongs to a family of new-generation LDO regulators that use innovative circuitry to achieve wide bandwidth and high loop gain, resulting in extremely high PSRR (over a 1-MHz range) even with very low headroom ($V_I - V_O$). A noise-reduction capacitor ($C_{(NR)}$) at the NR pin and a bypass capacitor ($C_{(BYPASS)}$) decrease noise generated by the bandgap reference to improve PSRR, while a quick-start circuit fast-charges the noise-reduction capacitor. This family of regulators offers sub-bandgap output voltages, current limit, and thermal protection, and is fully specified from -40°C to 125°C .

7.2 Functional Block Diagram

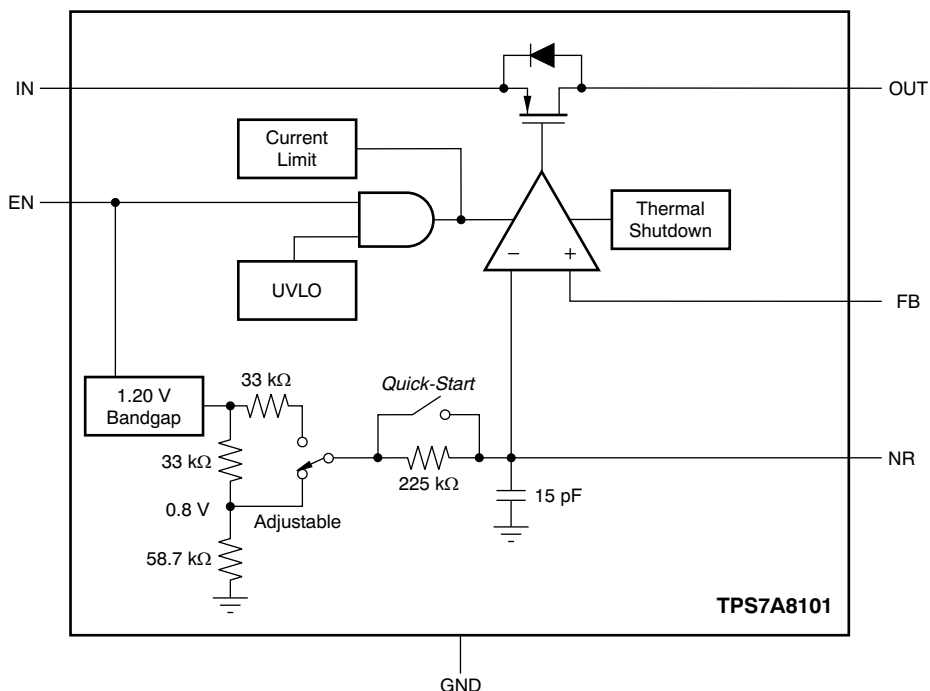

Figure 30. Functional Block Diagram

7.3 Feature Description

7.3.1 Internal Current Limit

The TPS7A8101 internal current limit helps protect the regulator during fault conditions. During current limit, the output sources a fixed amount of current that is largely independent of output voltage. For reliable operation, the device should not be operated in a current limit state for extended periods of time.

The PMOS pass element in the TPS7A8101 has a built-in body diode that conducts current when the voltage at OUT exceeds the voltage at IN. This current is not limited, so if extended reverse voltage operation is anticipated, external limiting may be appropriate.

7.3.2 Shutdown

The enable pin (EN) is active high and is compatible with standard and low voltage, TTL-CMOS levels. When shutdown capability is not required, EN can be connected to IN.

Feature Description (continued)

7.3.3 Start-Up

Through a lower resistance, the bandgap reference can quickly charge the noise reduction capacitor (C_{NR}). The TPS7A8101 has a *quick-start* circuit to quickly charge C_{NR} , if present; see the . At start-up, this quick-start switch is closed, with only 33 k Ω of resistance between the bandgap reference and the NR pin. The quick-start switch opens approximately 100 ms after any device enabling event, and the resistance between the bandgap reference and the NR pin becomes higher in value (approximately 250 k Ω) to form a very good low-pass (RC) filter. This low-pass filter achieves very good noise reduction for the reference voltage.

Inrush current can be a problem in many applications. The 33-k Ω resistance during the start-up period is intentionally put there to slow down the reference voltage ramp up, thus reducing the inrush current. For example, the capacitance of connecting the recommended C_{NR} value of 0.47 μ F along with the 33-k Ω resistance causes approximately 80-ms RC delay. Start-up time with the other C_{NR} values can be calculated as:

$$t_{STR} (s) = 170,000 \times C_{NR} (F) \quad (1)$$

Although the noise reduction effect is nearly saturated at 0.47 μ F, connecting a C_{NR} value greater than 0.47 μ F can help reduce noise slightly more; however, start-up time will be extremely long because the quick-start switch opens after approximately 100 ms. That is, if C_{NR} is not fully charged during this 100-ms period, C_{NR} finishes charging through a higher resistance of 250 k Ω , and takes much longer to fully charge.

A low leakage C_{NR} should be used; most ceramic capacitors are suitable.

7.3.4 Undervoltage Lock-Out (UVLO)

The TPS7A8101 uses an undervoltage lock-out circuit to keep the output shut off until the internal circuitry is operating properly. The UVLO circuit has a de-glitch feature so that it typically ignores undershoot transients on the input if they are less than 50- μ s duration.

7.4 Device Functional Modes

Driving the EN pin over 1.2 V for V_I from 2.2 V to 3.6 V or 1.35 V for V_I from 3.6 V to 6.5 V turns on the regulator. Driving the EN pin below 0.4 V causes the regulator to enter shutdown mode.

In shutdown, the current consumption of the device is reduced to 0.02 μ A typically.

8 Application and Implementation

NOTE

Information in the following applications sections is not part of the TI component specification, and TI does not warrant its accuracy or completeness. TI's customers are responsible for determining suitability of components for their purposes. Customers should validate and test their design implementation to confirm system functionality.

8.1 Application Information

The TPS7A8101 belongs to a family of new generation LDO regulators that use innovative circuitry to achieve wide bandwidth and high loop gain, resulting in extremely high PSRR (over a 1-MHz range) at very low headroom ($V_{IN} - V_{OUT}$). A noise reduction capacitor (C_{NR}) at the NR pin and a bypass capacitor (C_{BYPASS}) bypass noise generated by the bandgap reference to improve PSRR, while a quick-start circuit fast-charges the noise reduction capacitor. This family of regulators offers sub-bandgap output voltages, current limit, and thermal protection, and is fully specified from -40°C to 125°C .

8.1.1 Recommended Component Values

Table 1. Recommended Capacitor Values

SYMBOL	NAME	VALUE
C_{IN}	Input capacitor	10 μF
C_{OUT}	Output capacitor	10 μF
C_{NR}	Noise reduction capacitor between NR and GND	470 nF
C_{BYPASS}	Noise reduction capacitor across R_1	470 nF

Table 2. Recommended Feedback Resistor Values for Common Output Voltages

V_{OUT}	R_1	R_2
0.8 V	0 Ω (Short)	10 k Ω
1 V	2.49 k Ω	10 k Ω
1.2 V	4.99 k Ω	10 k Ω
1.5 V	8.87 k Ω	10 k Ω
1.8 V	12.5 k Ω	10 k Ω
2.5 V	21 k Ω	10 k Ω
3.3 V	30.9 k Ω	10 k Ω
5 V	52.3 k Ω	10 k Ω

8.2 Typical Application

Figure 31 illustrates the connections for the device.

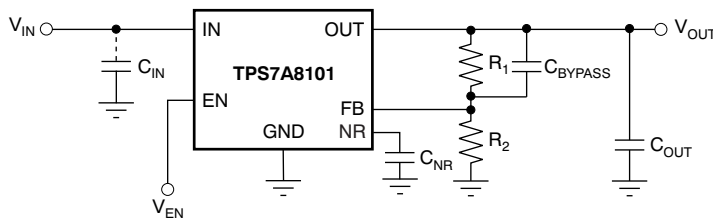

Figure 31. Typical Application Circuit

Typical Application (continued)

8.2.1 Design Requirements

8.2.1.1 Dropout Voltage

The TPS7A8101 uses a PMOS pass transistor to achieve low dropout. When $(V_{IN} - V_{OUT})$ is less than the dropout voltage (V_{DO}), the PMOS pass device is in its linear region of operation and the input-to-output resistance is the $R_{DS(ON)}$ of the PMOS pass element. V_{DO} scales approximately with output current because the PMOS device in dropout behaves the same way as a resistor.

As with any linear regulator, PSRR and transient response are degraded as $(V_{IN} - V_{OUT})$ approaches dropout. This effect is shown in [Figure 19](#) and [Figure 20](#) in the [Typical Characteristics](#) section.

8.2.1.2 Minimum Load

The TPS7A8101 is stable and well-behaved with no output load. Traditional PMOS LDO regulators suffer from lower loop gain at very light output loads. The TPS7A8101 employs an innovative low-current mode circuit to increase loop gain under very light or no-load conditions, resulting in improved output voltage regulation performance down to zero output current.

8.2.1.3 Input and Output Capacitor Requirements

Although an input capacitor is not required for stability, it is good analog design practice to connect a 0.1- μ F to 1- μ F low equivalent series resistance (ESR) capacitor across the input supply near the regulator. This capacitor counteracts reactive input sources and improves transient response, noise rejection, and ripple rejection. A higher-value capacitor may be necessary if large, fast rise-time load transients are anticipated or if the device is located several inches from the power source. If source impedance is not sufficiently low, a 0.1- μ F input capacitor may be necessary to ensure stability.

The TPS7A8101 is designed to be stable with standard ceramic capacitors of capacitance values 4.7 μ F or larger. This device is evaluated using a 10- μ F ceramic capacitor of 10-V rating, 10% tolerance, X5R type, and 0805 size (2 mm \times 1.25 mm).

X5R- and X7R-type capacitors are highly recommended because they have minimal variation in value and ESR over temperature. Maximum ESR should be less than 1 Ω .

8.2.2 Detailed Design Procedure

The voltage on the FB pin sets the output voltage and is determined by the values of R_1 and R_2 . The values of R_1 and R_2 can be calculated for any voltage using the formula given in [Equation 2](#):

$$V_{OUT} = \frac{(R_1 + R_2)}{R_2} \times 0.800 \quad (2)$$

[Table 2](#) shows sample resistor values for common output voltages. In [Table 2](#), E96 series resistors are used, and all values meet 1% of the target V_{OUT} , assuming resistors with zero error. For the actual design, pay attention to any resistor error factors. Using lower values for R_1 and R_2 reduces the noise injected from the FB pin.

8.2.2.1 Output Noise

In most LDOs, the bandgap is the dominant noise source. If a noise reduction capacitor (C_{NR}) is used with the TPS7A8101, the bandgap does not contribute significantly to noise. Instead, noise is dominated by the output resistor divider and the error amplifier input. If a bypass capacitor (C_{BYPASS}) across the high-side feedback resistor (R_1) is used with the TPS7A8101 in addition to C_{NR} , noise from these other sources can also be significantly reduced.

To maximize noise performance in a given application, use a 0.47- μ F noise-reduction capacitor plus a 0.47- μ F bypass capacitor.

Typical Application (continued)

8.2.2.2 Transient Response

As with any regulator, increasing the size of the output capacitor reduces overshoot and undershoot magnitude but increases duration of the transient response. Line transient performance can be improved by using a larger noise reduction capacitor (C_{NR}) and/or bypass capacitor (C_{BYPASS}).

8.2.3 Application Curve

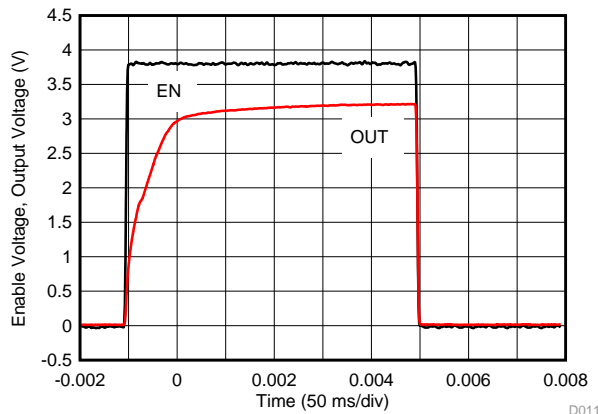

Figure 32. Enable Pulse Response

9 Power Supply Recommendations

The device is designed to operate from an input voltage supply range from 2.2 V to 6.5 V. The input voltage range should provide adequate headroom for the device to have a regulated output. This input supply should be well regulated. If the input supply is noisy, additional input capacitors with low ESR can help improve the output noise performance.

10 Layout

10.1 Layout Guidelines

10.1.1 Board Layout Recommendations to Improve PSRR and Noise Performance

To improve AC performance such as PSRR, output noise, and transient response, TI recommends designing the board with separate ground planes for V_{IN} and V_{OUT} , with each ground plane connected only at the GND pin of the device. In addition, the ground connection for the bypass capacitor should connect directly to the GND pin of the device.

10.2 Layout Example

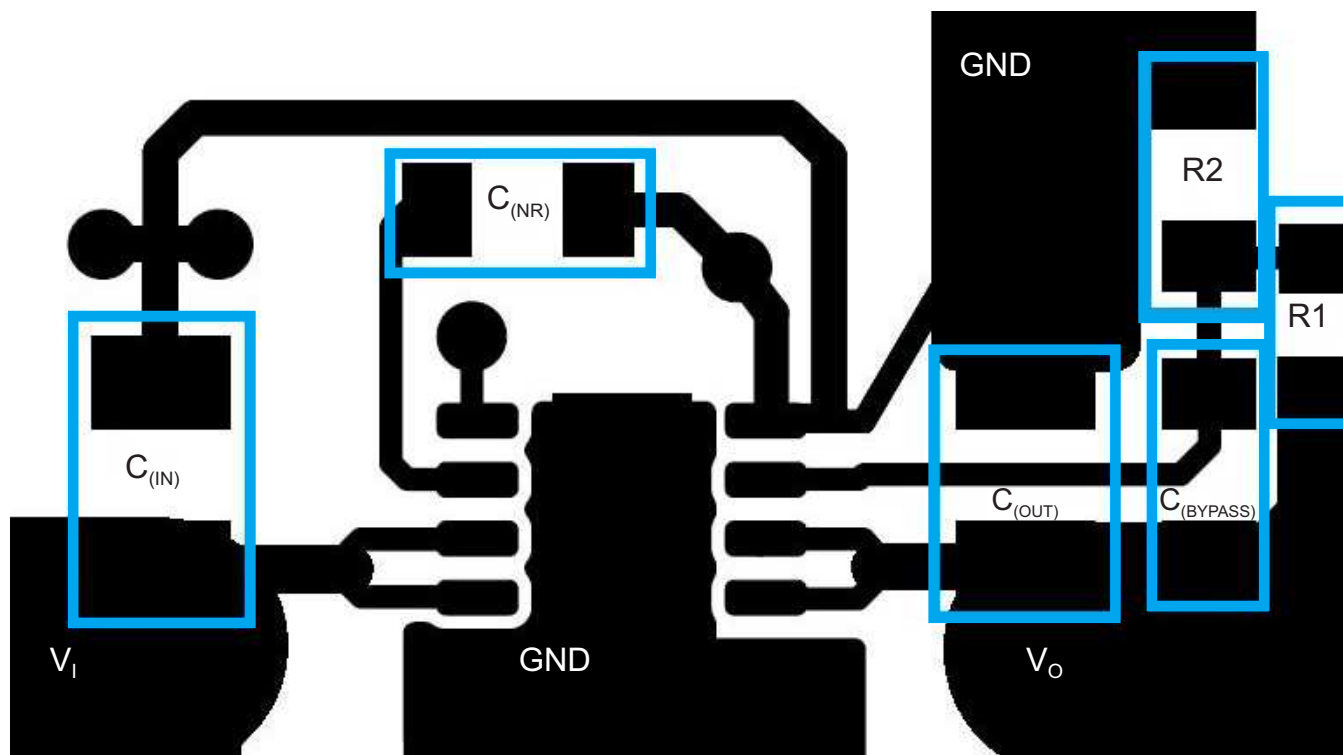

Figure 33. TPS7A8101 Layout Example

10.3 Thermal Protection

Thermal protection disables the output when the junction temperature rises to approximately 160°C, allowing the device to cool. When the junction temperature cools to approximately 140°C the output circuitry is again enabled. Depending on power dissipation, thermal resistance, and ambient temperature, the thermal protection circuit may cycle on and off. This cycling limits the dissipation of the regulator, protecting it from damage because of overheating.

Any tendency to activate the thermal protection circuit indicates excessive power dissipation or an inadequate heatsink. For reliable operation, junction temperature should be limited to 125°C maximum. To estimate the margin of safety in a complete design (including heatsink), increase the ambient temperature until the thermal protection is triggered; use worst-case loads and signal conditions. For good reliability, thermal protection should trigger at least 35°C above the maximum expected ambient condition of your particular application. This configuration produces a worst-case junction temperature of 125°C at the highest expected ambient temperature and worst-case load.

The internal protection circuitry of the TPS7A8101 has been designed to protect against overload conditions. It was not intended to replace proper heatsinking. Continuously running the TPS7A8101 into thermal shutdown degrades device reliability.

10.4 Power Dissipation

Knowing the device power dissipation and proper sizing of the thermal plane that is connected to the tab or pad is critical to avoiding thermal shutdown and ensuring reliable operation.

Power dissipation of the device depends on input voltage and load conditions and can be calculated using Equation 3:

$$P_D = (V_{IN} - V_{OUT}) \times I_{OUT} \quad (3)$$

Power dissipation can be minimized and greater efficiency can be achieved by using the lowest possible input voltage necessary to achieve the required output voltage regulation.

On the SON (DRB) package, the primary conduction path for heat is through the exposed pad to the printed-circuit-board (PCB). The pad can be connected to ground or be left floating; however, it should be attached to an appropriate amount of copper PCB area to ensure the device does not overheat. The maximum junction-to-ambient thermal resistance depends on the maximum ambient temperature, maximum device junction temperature, and power dissipation of the device and can be calculated using Equation 4:

$$R_{\theta JA} = \frac{(+125^{\circ}\text{C} - T_A)}{P_D} \quad (4)$$

Knowing the maximum $R_{\theta JA}$, the minimum amount of PCB copper area needed for appropriate heatsinking can be estimated using Figure 34.

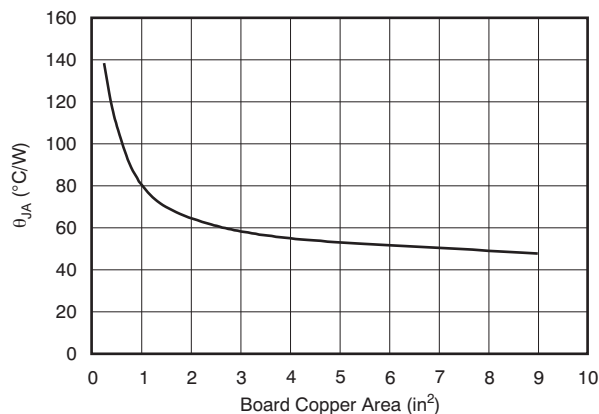

Note: θ_{JA} value at board size of 9 in² (that is, 3 in × 3 in) is a JEDEC standard.

Figure 34. θ_{JA} vs Board Size

Figure 34 shows the variation of θ_{JA} as a function of ground plane copper area in the board. It is intended only as a guideline to demonstrate the effects of heat spreading in the ground plane and should not be used to estimate actual thermal performance in real application environments.

NOTE

When the device is mounted on an application PCB, it is strongly recommended to use Ψ_{JT} and Ψ_{JB} , as explained in the [Estimating Junction Temperature](#) section.

10.5 Estimating Junction Temperature

Using the thermal metrics Ψ_{JT} and Ψ_{JB} , as shown in the [Thermal Information](#) table, the junction temperature can be estimated with corresponding formulas (given in Equation 5). For backwards compatibility, an older $\theta_{JC, Top}$ parameter is listed as well.

$$\begin{aligned} \Psi_{JT}: \quad T_J &= T_T + \Psi_{JT} \cdot P_D \\ \Psi_{JB}: \quad T_J &= T_B + \Psi_{JB} \cdot P_D \end{aligned} \quad (5)$$

Estimating Junction Temperature (continued)

Where P_D is the power dissipation shown by Equation 4, T_T is the temperature at the center-top of the IC package, and T_B is the PCB temperature measured 1 mm away from the IC package on the PCB surface (as Figure 35 shows).

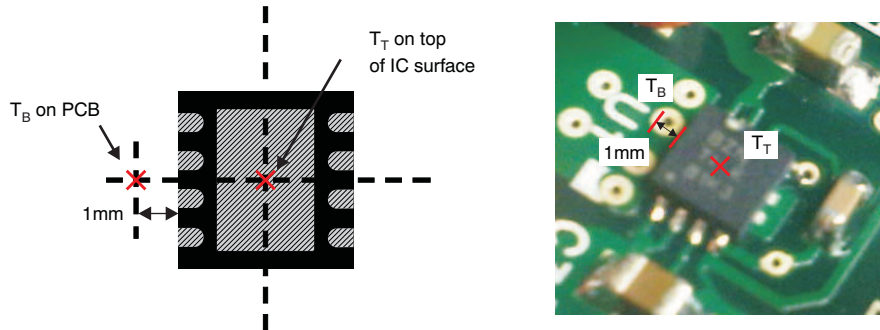

Figure 35. Measuring Points for T_T and T_B

NOTE

Both T_T and T_B can be measured on actual application boards using an infrared thermometer.

For more information about measuring T_T and T_B , see the application note SBVA025, *Using New Thermal Metrics*, available for download at www.ti.com.

By looking at Figure 36, the new thermal metrics (Ψ_{JT} and Ψ_{JB}) have very little dependency on board size. That is, using Ψ_{JT} or Ψ_{JB} with Equation 5 is a good way to estimate T_J by simply measuring T_T or T_B , regardless of the application board size.

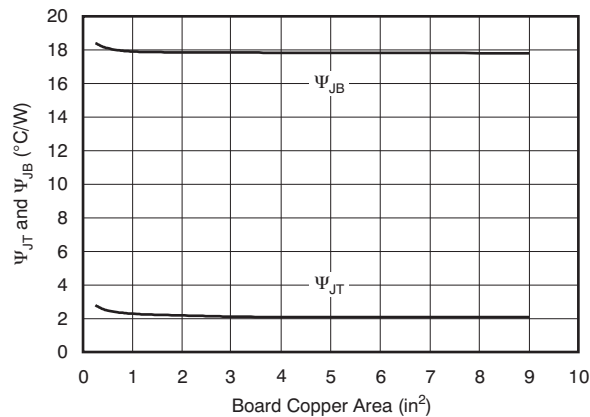

Figure 36. Ψ_{JT} and Ψ_{JB} vs Board Size

For a more detailed discussion of why TI does not recommend using $\theta_{JC(top)}$ to determine thermal characteristics, refer to application report SBVA025, *Using New Thermal Metrics*, available for download at www.ti.com. For further information, refer to application report SPRA953, *IC Package Thermal Metrics*, also available on the TI website.

11 Device and Documentation Support

11.1 Device Support

11.1.1 Device Nomenclature

PRODUCT	V _{OUT}
TPS7A8101yyyz	YYY is package designator. Z is package quantity.

11.2 Documentation Support

11.2.1 Related Documentation

For related documentation see the following:

- *LDO noise examined in detail*, [SLYT489](#)
- *LDO Performance Near Dropout*, [SBVA029](#)
- *TPS7A8101EVM Evaluation Module*, [SLVU600](#)
- *Wide Bandwidth PSRR of LDOs* by Nogawa and Van Renterghem in *Bodo's Power Systems®: Electronics in Motion and Conversion*, March 2011

11.3 Community Resources

The following links connect to TI community resources. Linked contents are provided "AS IS" by the respective contributors. They do not constitute TI specifications and do not necessarily reflect TI's views; see TI's [Terms of Use](#).

TI E2E™ Online Community *TI's Engineer-to-Engineer (E2E) Community*. Created to foster collaboration among engineers. At e2e.ti.com, you can ask questions, share knowledge, explore ideas and help solve problems with fellow engineers.

Design Support *TI's Design Support* Quickly find helpful E2E forums along with design support tools and contact information for technical support.

11.4 Trademarks

E2E is a trademark of Texas Instruments.
Bodo's Power Systems is a registered trademark of Arlt Bodo.
All other trademarks are the property of their respective owners.

11.5 Electrostatic Discharge Caution



These devices have limited built-in ESD protection. The leads should be shorted together or the device placed in conductive foam during storage or handling to prevent electrostatic damage to the MOS gates.

11.6 Glossary

[SLYZ022](#) — *TI Glossary*.

This glossary lists and explains terms, acronyms, and definitions.

12 Mechanical, Packaging, and Orderable Information

The following pages include mechanical, packaging, and orderable information. This information is the most current data available for the designated devices. This data is subject to change without notice and revision of this document. For browser-based versions of this data sheet, refer to the left-hand navigation.

PACKAGING INFORMATION

Orderable Device	Status (1)	Package Type	Package Drawing	Pins	Package Qty	Eco Plan (2)	Lead/Ball Finish (6)	MSL Peak Temp (3)	Op Temp (°C)	Device Marking (4/5)	Samples
TPS7A8101DRBR	ACTIVE	SON	DRB	8	3000	Green (RoHS & no Sb/Br)	CU NIPDAU	Level-2-260C-1 YEAR	-40 to 125	SAU	Samples
TPS7A8101DRBT	ACTIVE	SON	DRB	8	250	Green (RoHS & no Sb/Br)	CU NIPDAU	Level-2-260C-1 YEAR	-40 to 125	SAU	Samples

(1) The marketing status values are defined as follows:

ACTIVE: Product device recommended for new designs.

LIFEBUY: TI has announced that the device will be discontinued, and a lifetime-buy period is in effect.

NRND: Not recommended for new designs. Device is in production to support existing customers, but TI does not recommend using this part in a new design.

PREVIEW: Device has been announced but is not in production. Samples may or may not be available.

OBSOLETE: TI has discontinued the production of the device.

(2) Eco Plan - The planned eco-friendly classification: Pb-Free (RoHS), Pb-Free (RoHS Exempt), or Green (RoHS & no Sb/Br) - please check <http://www.ti.com/productcontent> for the latest availability information and additional product content details.

TBD: The Pb-Free/Green conversion plan has not been defined.

Pb-Free (RoHS): TI's terms "Lead-Free" or "Pb-Free" mean semiconductor products that are compatible with the current RoHS requirements for all 6 substances, including the requirement that lead not exceed 0.1% by weight in homogeneous materials. Where designed to be soldered at high temperatures, TI Pb-Free products are suitable for use in specified lead-free processes.

Pb-Free (RoHS Exempt): This component has a RoHS exemption for either 1) lead-based flip-chip solder bumps used between the die and package, or 2) lead-based die adhesive used between the die and leadframe. The component is otherwise considered Pb-Free (RoHS compatible) as defined above.

Green (RoHS & no Sb/Br): TI defines "Green" to mean Pb-Free (RoHS compatible), and free of Bromine (Br) and Antimony (Sb) based flame retardants (Br or Sb do not exceed 0.1% by weight in homogeneous material)

(3) MSL, Peak Temp. - The Moisture Sensitivity Level rating according to the JEDEC industry standard classifications, and peak solder temperature.

(4) There may be additional marking, which relates to the logo, the lot trace code information, or the environmental category on the device.

(5) Multiple Device Markings will be inside parentheses. Only one Device Marking contained in parentheses and separated by a "~" will appear on a device. If a line is indented then it is a continuation of the previous line and the two combined represent the entire Device Marking for that device.

(6) Lead/Ball Finish - Orderable Devices may have multiple material finish options. Finish options are separated by a vertical ruled line. Lead/Ball Finish values may wrap to two lines if the finish value exceeds the maximum column width.

Important Information and Disclaimer: The information provided on this page represents TI's knowledge and belief as of the date that it is provided. TI bases its knowledge and belief on information provided by third parties, and makes no representation or warranty as to the accuracy of such information. Efforts are underway to better integrate information from third parties. TI has taken and continues to take reasonable steps to provide representative and accurate information but may not have conducted destructive testing or chemical analysis on incoming materials and chemicals. TI and TI suppliers consider certain information to be proprietary, and thus CAS numbers and other limited information may not be available for release.

In no event shall TI's liability arising out of such information exceed the total purchase price of the TI part(s) at issue in this document sold by TI to Customer on an annual basis.

OTHER QUALIFIED VERSIONS OF TPS7A8101 :

- Automotive: [TPS7A8101-Q1](#)

NOTE: Qualified Version Definitions:

- Automotive - Q100 devices qualified for high-reliability automotive applications targeting zero defects

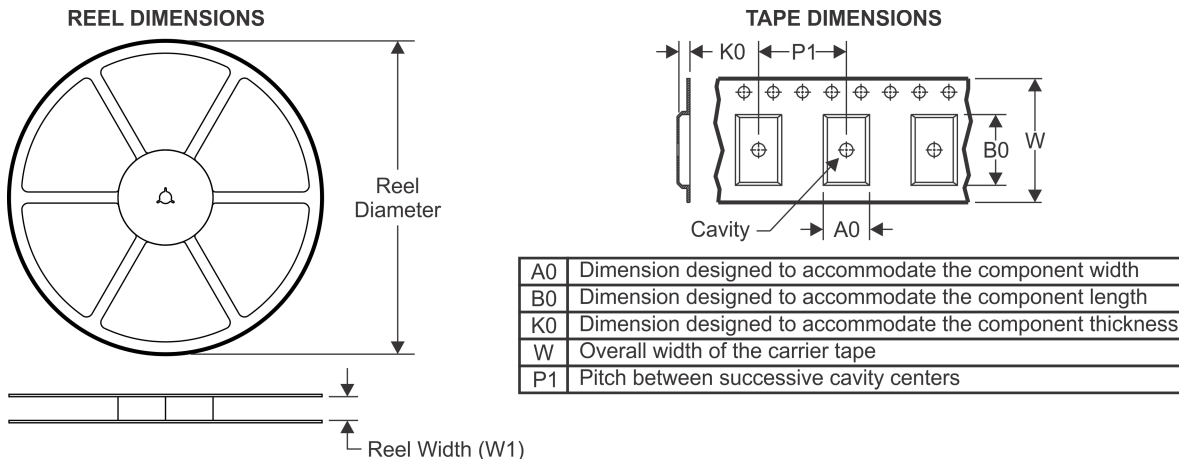
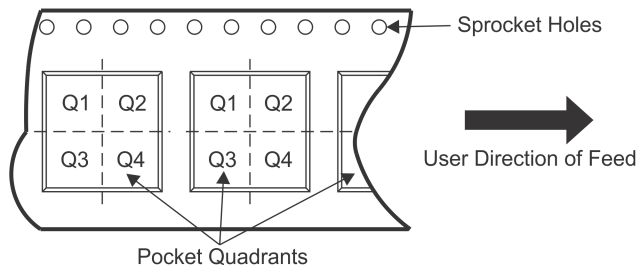
TAPE AND REEL INFORMATION

QUADRANT ASSIGNMENTS FOR PIN 1 ORIENTATION IN TAPE

*All dimensions are nominal

Device	Package Type	Package Drawing	Pins	SPQ	Reel Diameter (mm)	Reel Width W1 (mm)	A0 (mm)	B0 (mm)	K0 (mm)	P1 (mm)	W (mm)	Pin1 Quadrant
TPS7A8101DRBR	SON	DRB	8	3000	330.0	12.4	3.3	3.3	1.1	8.0	12.0	Q2
TPS7A8101DRBT	SON	DRB	8	250	180.0	12.4	3.3	3.3	1.1	8.0	12.0	Q2

TAPE AND REEL BOX DIMENSIONS

*All dimensions are nominal

Device	Package Type	Package Drawing	Pins	SPQ	Length (mm)	Width (mm)	Height (mm)
TPS7A8101DRBR	SON	DRB	8	3000	367.0	367.0	35.0
TPS7A8101DRBT	SON	DRB	8	250	210.0	185.0	35.0

DRB 8

GENERIC PACKAGE VIEW

VSON - 1 mm max height

PLASTIC SMALL OUTLINE - NO LEAD



Images above are just a representation of the package family, actual package may vary.
Refer to the product data sheet for package details.

4203482/L

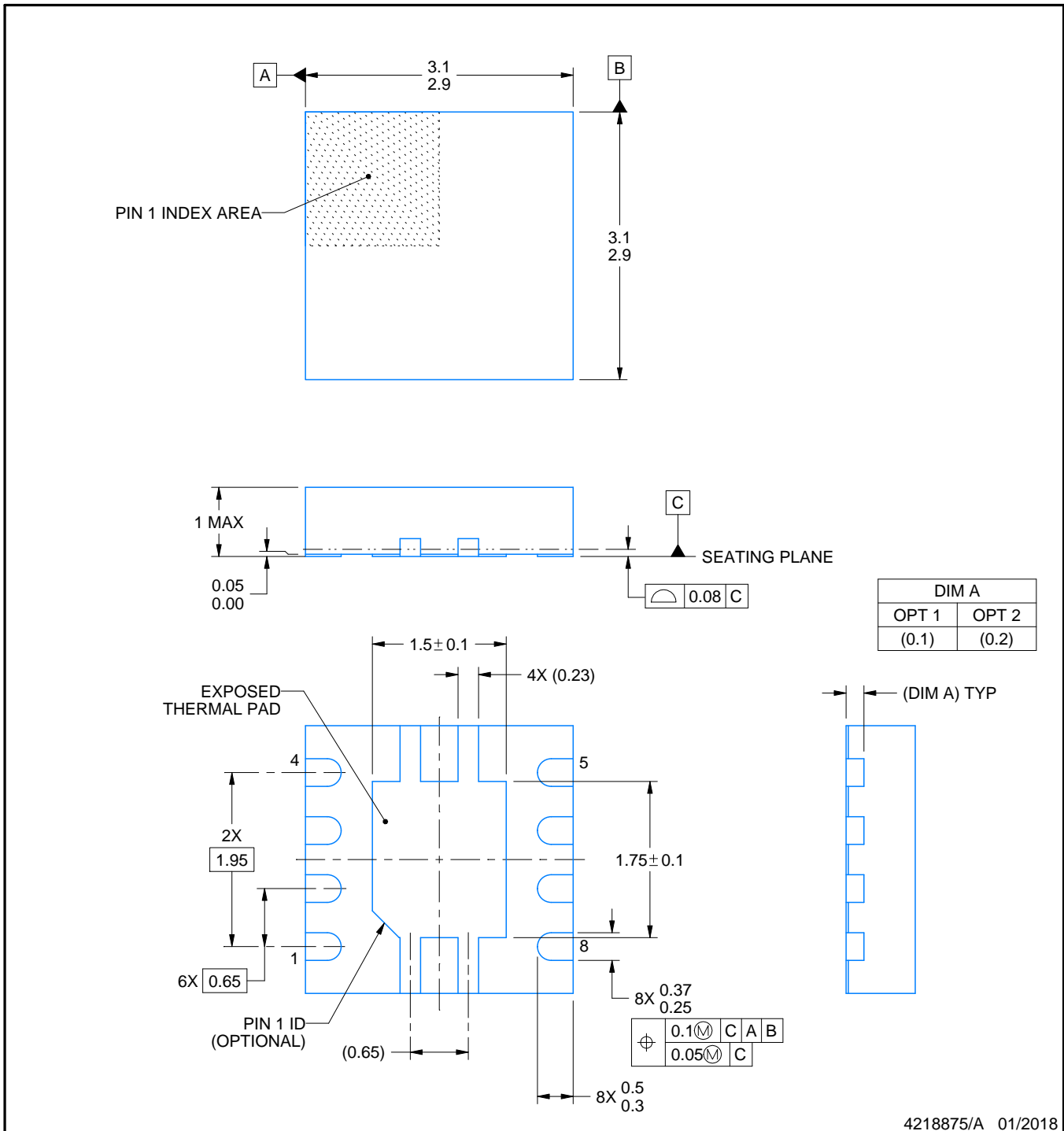

4218875/A 01/2018

NOTES:

1. All linear dimensions are in millimeters. Any dimensions in parenthesis are for reference only. Dimensioning and tolerancing per ASME Y14.5M.
2. This drawing is subject to change without notice.
3. The package thermal pad must be soldered to the printed circuit board for thermal and mechanical performance.

EXAMPLE BOARD LAYOUT

DRB0008A

VSON - 1 mm max height

PLASTIC SMALL OUTLINE - NO LEAD

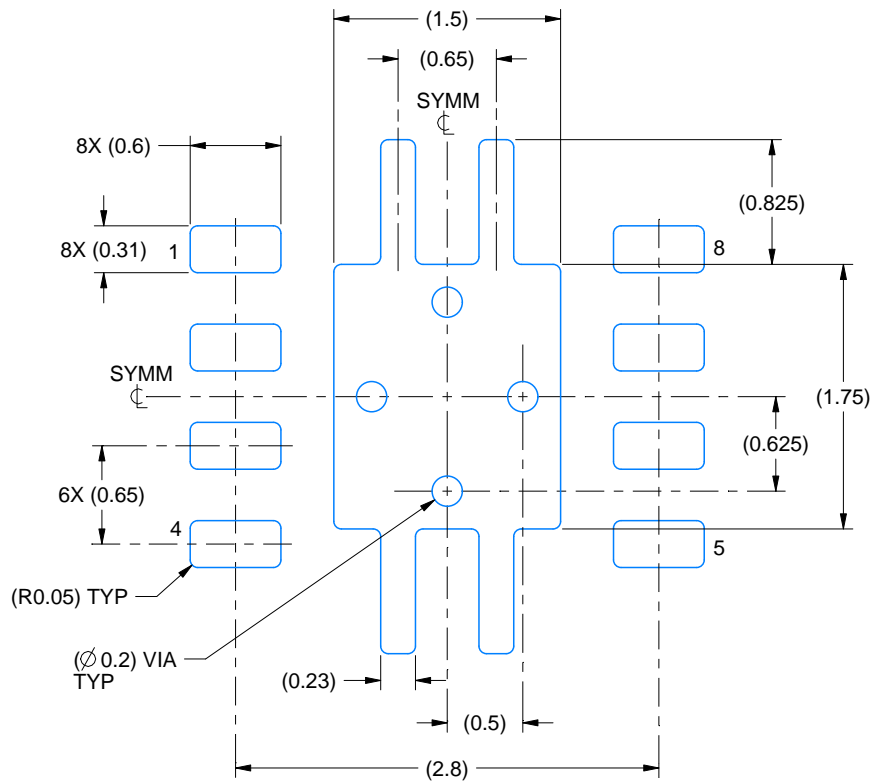

LAND PATTERN EXAMPLE
EXPOSED METAL SHOWN
SCALE:20X

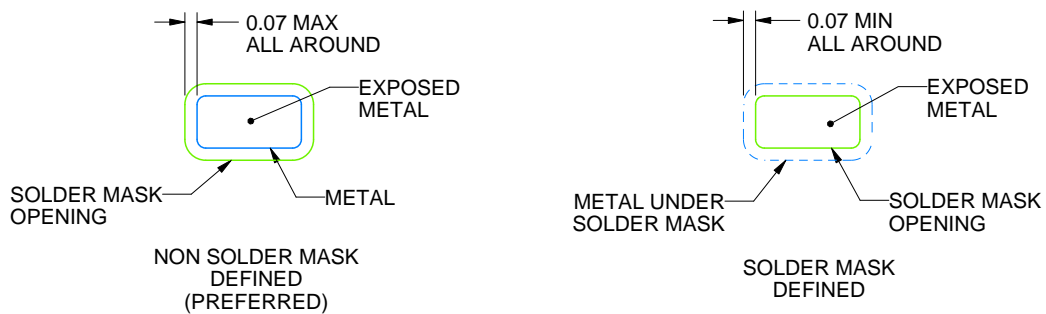

SOLDER MASK DETAILS

4218875/A 01/2018

NOTES: (continued)

4. This package is designed to be soldered to a thermal pad on the board. For more information, see Texas Instruments literature number SLUA271 (www.ti.com/lit/sluea271).
5. Vias are optional depending on application, refer to device data sheet. If any vias are implemented, refer to their locations shown on this view. It is recommended that vias under paste be filled, plugged or tented.

EXAMPLE STENCIL DESIGN

DRB0008A

VSON - 1 mm max height

PLASTIC SMALL OUTLINE - NO LEAD

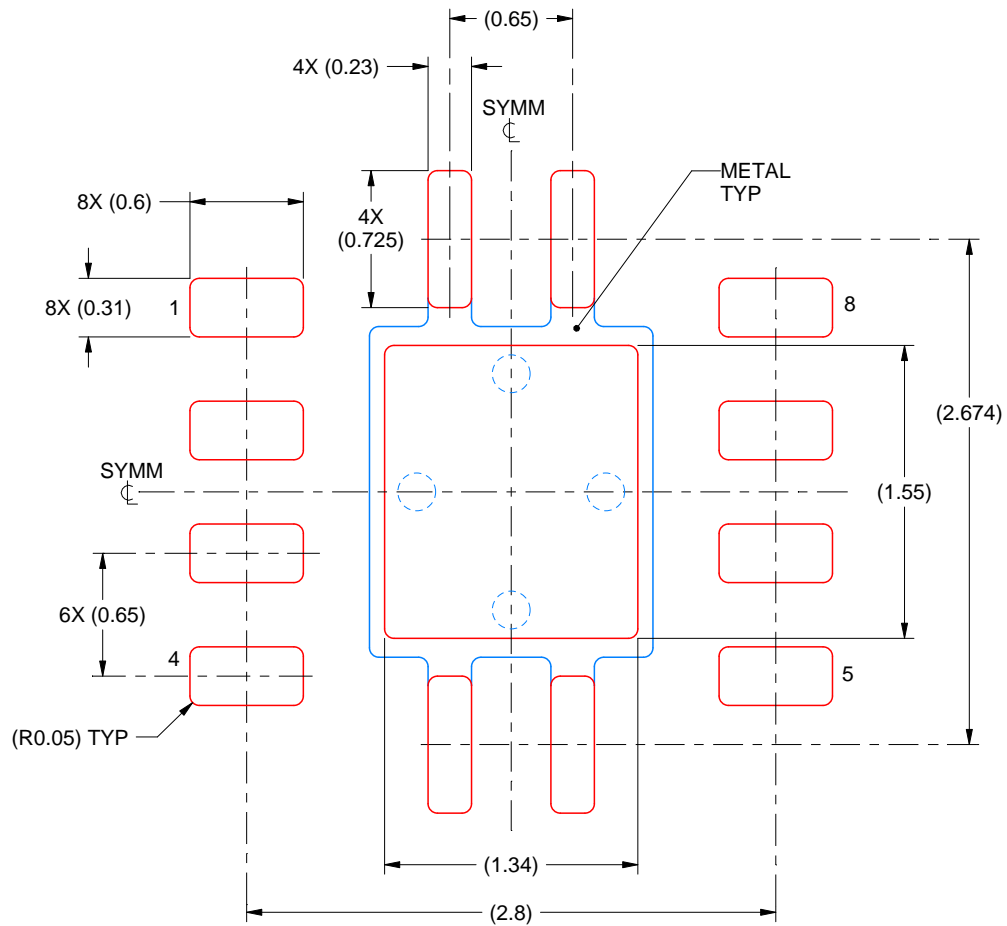

SOLDER PASTE EXAMPLE
BASED ON 0.125 mm THICK STENCIL

EXPOSED PAD
84% PRINTED SOLDER COVERAGE BY AREA
SCALE:25X

4218875/A 01/2018

NOTES: (continued)

6. Laser cutting apertures with trapezoidal walls and rounded corners may offer better paste release. IPC-7525 may have alternate design recommendations.

IMPORTANT NOTICE

Texas Instruments Incorporated (TI) reserves the right to make corrections, enhancements, improvements and other changes to its semiconductor products and services per JESD46, latest issue, and to discontinue any product or service per JESD48, latest issue. Buyers should obtain the latest relevant information before placing orders and should verify that such information is current and complete.

TI's published terms of sale for semiconductor products (<http://www.ti.com/sc/docs/stdterms.htm>) apply to the sale of packaged integrated circuit products that TI has qualified and released to market. Additional terms may apply to the use or sale of other types of TI products and services.

Reproduction of significant portions of TI information in TI data sheets is permissible only if reproduction is without alteration and is accompanied by all associated warranties, conditions, limitations, and notices. TI is not responsible or liable for such reproduced documentation. Information of third parties may be subject to additional restrictions. Resale of TI products or services with statements different from or beyond the parameters stated by TI for that product or service voids all express and any implied warranties for the associated TI product or service and is an unfair and deceptive business practice. TI is not responsible or liable for any such statements.

Buyers and others who are developing systems that incorporate TI products (collectively, "Designers") understand and agree that Designers remain responsible for using their independent analysis, evaluation and judgment in designing their applications and that Designers have full and exclusive responsibility to assure the safety of Designers' applications and compliance of their applications (and of all TI products used in or for Designers' applications) with all applicable regulations, laws and other applicable requirements. Designer represents that, with respect to their applications, Designer has all the necessary expertise to create and implement safeguards that (1) anticipate dangerous consequences of failures, (2) monitor failures and their consequences, and (3) lessen the likelihood of failures that might cause harm and take appropriate actions. Designer agrees that prior to using or distributing any applications that include TI products, Designer will thoroughly test such applications and the functionality of such TI products as used in such applications.

TI's provision of technical, application or other design advice, quality characterization, reliability data or other services or information, including, but not limited to, reference designs and materials relating to evaluation modules, (collectively, "TI Resources") are intended to assist designers who are developing applications that incorporate TI products; by downloading, accessing or using TI Resources in any way, Designer (individually or, if Designer is acting on behalf of a company, Designer's company) agrees to use any particular TI Resource solely for this purpose and subject to the terms of this Notice.

TI's provision of TI Resources does not expand or otherwise alter TI's applicable published warranties or warranty disclaimers for TI products, and no additional obligations or liabilities arise from TI providing such TI Resources. TI reserves the right to make corrections, enhancements, improvements and other changes to its TI Resources. TI has not conducted any testing other than that specifically described in the published documentation for a particular TI Resource.

Designer is authorized to use, copy and modify any individual TI Resource only in connection with the development of applications that include the TI product(s) identified in such TI Resource. NO OTHER LICENSE, EXPRESS OR IMPLIED, BY ESTOPPEL OR OTHERWISE TO ANY OTHER TI INTELLECTUAL PROPERTY RIGHT, AND NO LICENSE TO ANY TECHNOLOGY OR INTELLECTUAL PROPERTY RIGHT OF TI OR ANY THIRD PARTY IS GRANTED HEREIN, including but not limited to any patent right, copyright, mask work right, or other intellectual property right relating to any combination, machine, or process in which TI products or services are used. Information regarding or referencing third-party products or services does not constitute a license to use such products or services, or a warranty or endorsement thereof. Use of TI Resources may require a license from a third party under the patents or other intellectual property of the third party, or a license from TI under the patents or other intellectual property of TI.

TI RESOURCES ARE PROVIDED "AS IS" AND WITH ALL FAULTS. TI DISCLAIMS ALL OTHER WARRANTIES OR REPRESENTATIONS, EXPRESS OR IMPLIED, REGARDING RESOURCES OR USE THEREOF, INCLUDING BUT NOT LIMITED TO ACCURACY OR COMPLETENESS, TITLE, ANY EPIDEMIC FAILURE WARRANTY AND ANY IMPLIED WARRANTIES OF MERCHANTABILITY, FITNESS FOR A PARTICULAR PURPOSE, AND NON-INFRINGEMENT OF ANY THIRD PARTY INTELLECTUAL PROPERTY RIGHTS. TI SHALL NOT BE LIABLE FOR AND SHALL NOT DEFEND OR INDEMNIFY DESIGNER AGAINST ANY CLAIM, INCLUDING BUT NOT LIMITED TO ANY INFRINGEMENT CLAIM THAT RELATES TO OR IS BASED ON ANY COMBINATION OF PRODUCTS EVEN IF DESCRIBED IN TI RESOURCES OR OTHERWISE. IN NO EVENT SHALL TI BE LIABLE FOR ANY ACTUAL, DIRECT, SPECIAL, COLLATERAL, INDIRECT, PUNITIVE, INCIDENTAL, CONSEQUENTIAL OR EXEMPLARY DAMAGES IN CONNECTION WITH OR ARISING OUT OF TI RESOURCES OR USE THEREOF, AND REGARDLESS OF WHETHER TI HAS BEEN ADVISED OF THE POSSIBILITY OF SUCH DAMAGES.

Unless TI has explicitly designated an individual product as meeting the requirements of a particular industry standard (e.g., ISO/TS 16949 and ISO 26262), TI is not responsible for any failure to meet such industry standard requirements.

Where TI specifically promotes products as facilitating functional safety or as compliant with industry functional safety standards, such products are intended to help enable customers to design and create their own applications that meet applicable functional safety standards and requirements. Using products in an application does not by itself establish any safety features in the application. Designers must ensure compliance with safety-related requirements and standards applicable to their applications. Designer may not use any TI products in life-critical medical equipment unless authorized officers of the parties have executed a special contract specifically governing such use. Life-critical medical equipment is medical equipment where failure of such equipment would cause serious bodily injury or death (e.g., life support, pacemakers, defibrillators, heart pumps, neurostimulators, and implantables). Such equipment includes, without limitation, all medical devices identified by the U.S. Food and Drug Administration as Class III devices and equivalent classifications outside the U.S.

TI may expressly designate certain products as completing a particular qualification (e.g., Q100, Military Grade, or Enhanced Product). Designers agree that it has the necessary expertise to select the product with the appropriate qualification designation for their applications and that proper product selection is at Designers' own risk. Designers are solely responsible for compliance with all legal and regulatory requirements in connection with such selection.

Designer will fully indemnify TI and its representatives against any damages, costs, losses, and/or liabilities arising out of Designer's non-compliance with the terms and provisions of this Notice.

Looking for pricing, stock, or lifecycle information?

Click below to explore more details on WIN SOURCE:

 [View TPS7A8101DRBT](#) on WIN SOURCE

 [Texas Instruments](#) Information

Optimize Your Supply Chain with WIN SOURCE Solutions

-  Global Sourcing Solution
-  Obsolete Management
-  Cost Control Management
-  Shortage Management
-  Alternative Solution
-  Excess Inventory Management