



**THE DATASHEET OF
ULQ2001D1013TR**



Seven Darlington array

Features

- Seven Darlington per package
- Extended temperature range: -40 to 105 °C
- Output current 500 mA per driver (600 mA peak)
- Output voltage 50 V
- Automotive Grade product in SO16 package
- Integrated suppression diodes for inductive loads
- Outputs can be paralleled for higher current
- TTL/CMOS/PMOS/DTL compatible inputs
- Inputs pinned opposite outputs to simplify layout

Description

The ULQ2001, ULQ2003 and ULQ2004 are high voltage, high current Darlington arrays each containing seven open collector Darlington pairs with common emitters. Each channel rated at 500 mA and can withstand peak currents of 600 mA. Suppression diodes are included for inductive load driving and the inputs are pinned opposite the outputs to simplify board layout. The versions interface to all common logic families. These versatile devices are useful for driving a wide range of loads including solenoids, relays DC

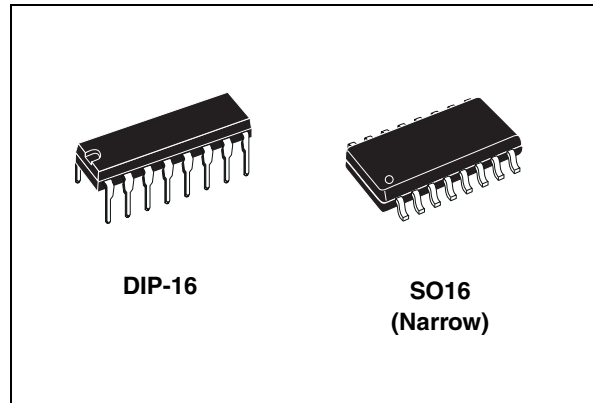

motors, LED displays filament lamps, thermal print-heads and high power buffers. The ULQ2001A/2003A and 2004A are supplied in 16 pin plastic DIP packages with a copper lead-frame to reduce thermal resistance. They are available also in small outline package (SO16) as ULQ2003D1/2004D1. The ULQ2003 is available as Automotive Grade in SO16 package. The commercial part numbers is shown in the order codes. This device is qualified according to the specification AEC-Q100 of the Automotive market, in the temperature range -40 °C to 125 °C and the statistical tests PAT, SYL, SBL are performed.

Table 1. Device summary

Part numbers	Order codes	Description	Packages
ULQ2001	ULQ2001A	General purpose, DTL, TTL, PMOS, CMOS	DIP-16
ULQ2003	ULQ2003A	5 V TTL, CMOS	DIP-16
ULQ2004	ULQ2004A	6–15 V CMOS, PMOS	DIP-16
ULQ2003	ULQ2003D1013TR		SO16 in tape and reel
ULQ2003	ULQ2003D1013TRY ⁽¹⁾		SO16 in tape and reel
ULQ2004	ULQ2004D1013TR		SO16 in tape and reel

1. Automotive Grade products.

Contents

1	Diagram	3
2	Pin configuration	4
3	Maximum ratings	5
4	Electrical characteristics	6
5	Test circuits	8
6	Package mechanical data	10
7	Revision history	13

1 Diagram

Figure 1. Schematic diagram

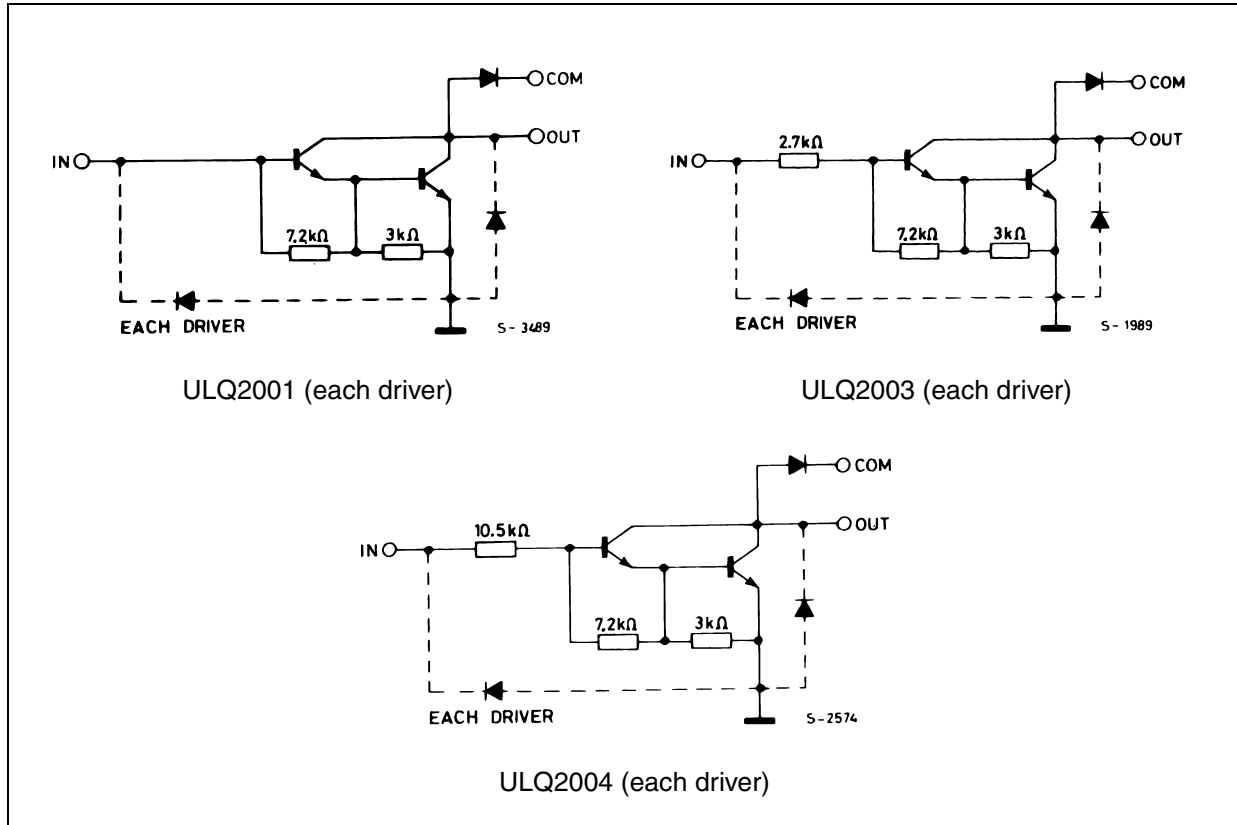

2 Pin configuration

Figure 2. Pin connections (top view)

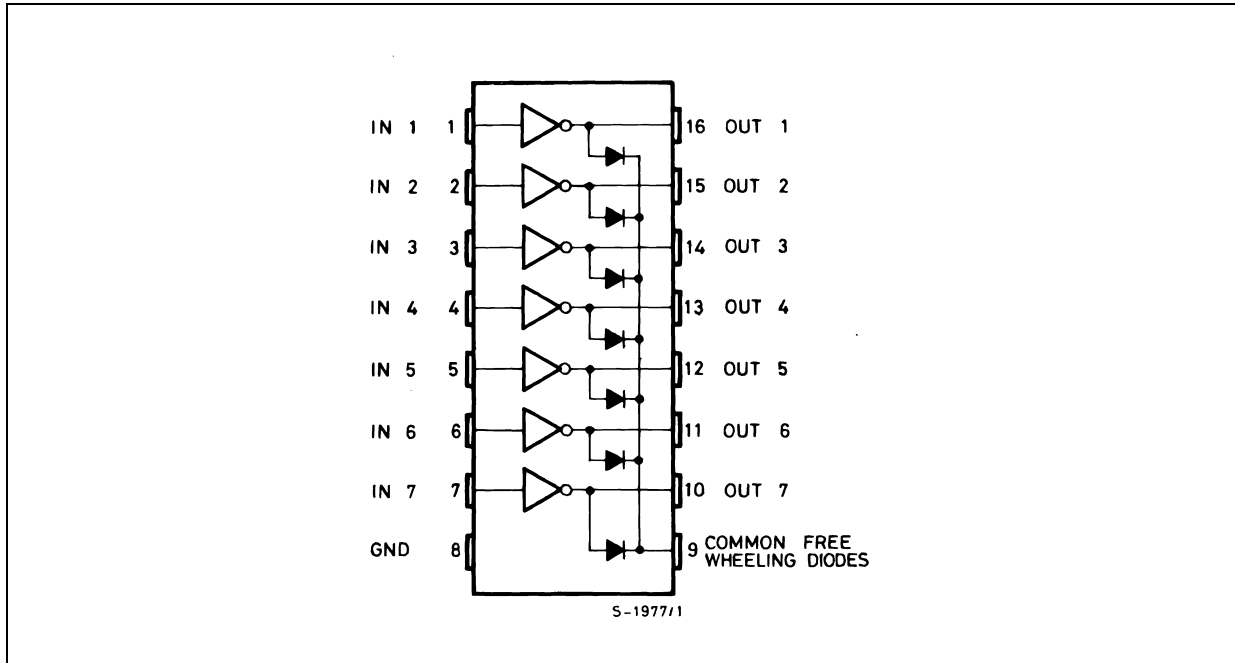

3 Maximum ratings

Table 2. Absolute maximum ratings

Symbol	Parameter	Value	Unit
V_O	Output voltage	50	V
V_{IN}	Input voltage (for ULQ2003A/D1 - 2004A/D1)	30	V
I_C	Continuous collector current	500	mA
I_B	Continuous base current	25	mA
T_A	Operating ambient temperature range	-40 to 105	°C
T_{STG}	Storage temperature range	-55 to 150	°C
T_J	Junction temperature	150	°C

Table 3. Thermal data

Symbol	Parameter	DIP-16	SO16	Unit
R_{thJA}	Thermal resistance junction-ambient, max.	70	120	°C/W

4 Electrical characteristics

$T_J = -40$ to 105 °C for DIP16 unless otherwise specified,
 $T_J = -25$ to 105 °C for SO16 unless otherwise specified.

Table 4. Electrical characteristics

Symbol	Parameter	Test conditions	Min.	Typ.	Max.	Unit
I_{CEX}	Output leakage current	$V_{CE} = 50V$, (Figure 3)			50	μA
		$T_J = 105^\circ C$, $V_{CE} = 50V$ (Figure 3)			100	
		$T_J = 105^\circ C$ for ULQ2004, $V_{CE} = 50V$, $V_I = 1V$ (Figure 4)			500	
$V_{CE(SAT)}$	Collector-emitter saturation voltage (Figure 5)	$I_C = 100mA$, $I_B = 250\mu A$		0.9	1.1	V
		$I_C = 200mA$, $I_B = 350\mu A$		1.1	1.3	
		$I_C = 350mA$, $I_B = 500\mu A$		1.3	1.6	
$I_{I(ON)}$	Input current (Figure 6)	for ULQ2003, $V_I = 3.85V$		0.93	1.35	mA
		for ULQ2004, $V_I = 5V$		0.35	0.5	
		for ULQ2004, $V_I = 12V$		1	1.45	
$I_{I(OFF)}$	Input current (Figure 7)	$T_J = 105^\circ C$, $I_C = 500\mu A$	50	65		μA
$V_{I(ON)}$	Input voltage (Figure 8)	for ULQ2003			2.4	V
		$V_{CE} = 2V$, $I_C = 200mA$			2.7	
		$V_{CE} = 2V$, $I_C = 250mA$			3	
		$V_{CE} = 2V$, $I_C = 300mA$			3	
		for ULQ2004			5	
		$V_{CE} = 2V$, $I_C = 125mA$			6	
		$V_{CE} = 2V$, $I_C = 200mA$			7	
$V_{CE} = 2V$, $I_C = 275mA$			8			
$V_{CE} = 2V$, $I_C = 350mA$			8			
h_{FE}	DC forward current gain (Figure 5)	for ULQ2001, $V_{CE} = 2V$, $I_C = 350mA$	1000			
C_I	Input capacitance			15	25 ⁽¹⁾	pF
t_{PLH}	Turn-on delay time	$0.5 V_I$ to $0.5 V_O$		0.25	1 ⁽¹⁾	μs
t_{PHL}	Turn-off delay time	$0.5 V_I$ to $0.5 V_O$		0.25	1 ⁽¹⁾	μs
I_R	Clamp diode leakage current (Figure 9)	$V_R = 50V$			50	μA
		$T_J = 105^\circ C$, $V_R = 50V$			100	
V_F	Clamp diode forward voltage (Figure 10)	$I_F = 350mA$		1.7	2	V

1. Guaranteed by design.

T_J = -40 to 125 °C for SO16 unless otherwise specified.

Table 5. Electrical characteristics for ULQ2003D1013TRY (Automotive Grade)

Symbol	Parameter	Test conditions	Min.	Typ.	Max.	Unit
I _{CEX}	Output leakage current (Figure 3)	V _{CE} = 50V			50	μA
V _{CE(SAT)}	Collector-emitter saturation voltage (Figure 5)	I _C = 100mA, I _B = 250μA		0.9	1.1	V
		I _C = 200mA, I _B = 350μA		1.1	1.3	
		I _C = 350mA, I _B = 500μA		1.3	1.6	
I _{I(ON)}	Input current (Figure 6)	V _I = 3.85V		0.93	1.35	mA
I _{I(OFF)}	Input current (Figure 7)	I _C = 500μA	50	65		μA
V _{I(ON)}	Input voltage (Figure 8)	V _{CE} = 2V, I _C = 200mA V _{CE} = 2V, I _C = 250mA V _{CE} = 2V, I _C = 300mA			2.4 2.7 3	V
C _I	Input capacitance			15	25	pF
t _{PLH}	Turn-on delay time	0.5 V _I to 0.5V _O		0.25	1	μs
t _{PHL}	Turn-off delay time	0.5 V _I to 0.5V _O		0.25	1	μs
I _R	Clamp diode leakage current (Figure 9)	V _R = 50V			50	μA
V _F	Clamp diode forward voltage (Figure 10)	I _F = 350mA		1.7	2	V

5 Test circuits

Figure 3. Output leakage current

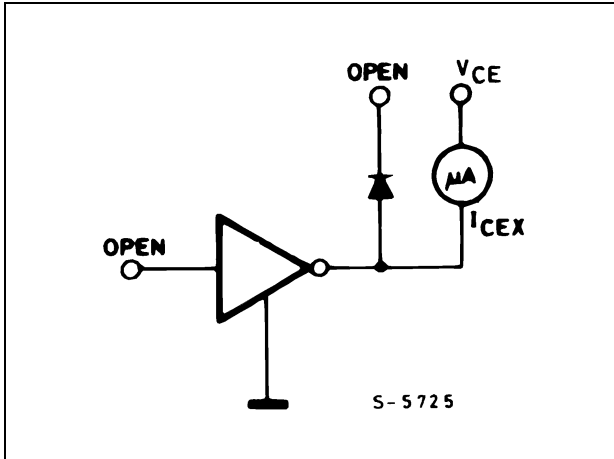

Figure 4. Output leakage current (for ULN2002 only)

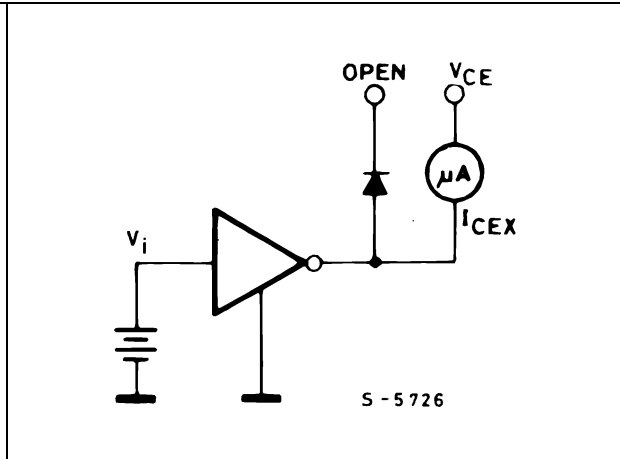

Figure 5. Collector-emitter saturation voltage Figure 6. Input current (ON)

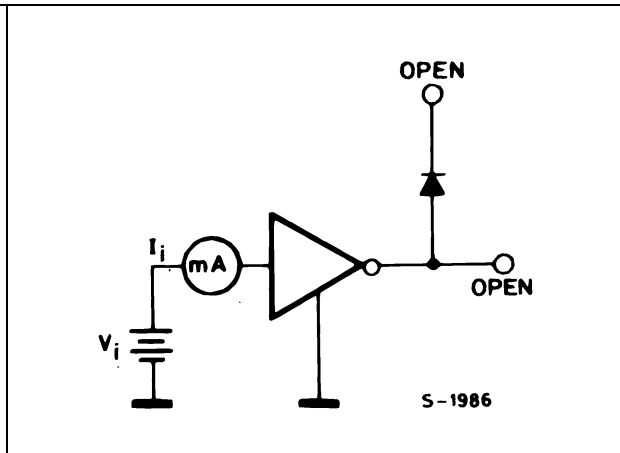
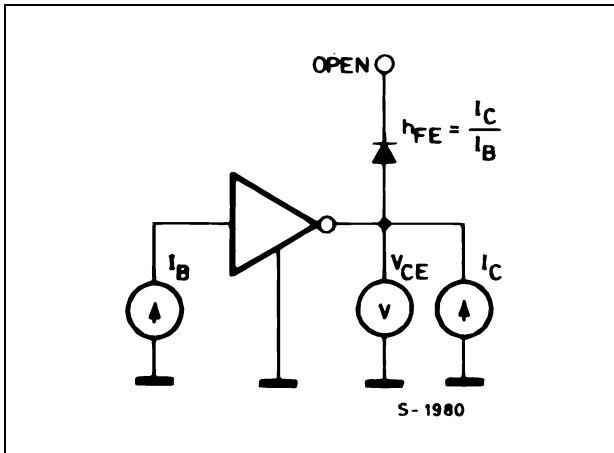

Figure 7. Input current (OFF)

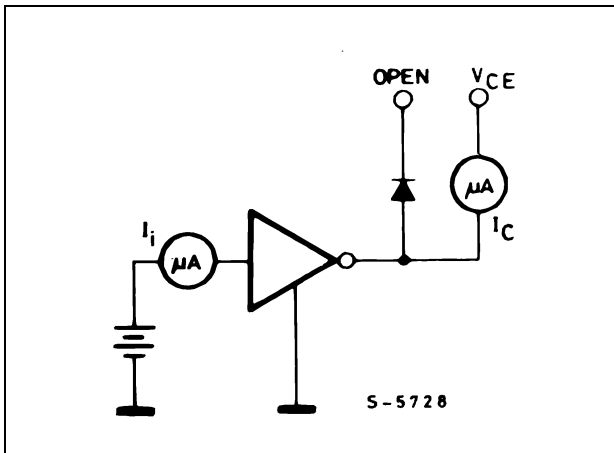

Figure 8. Input voltage

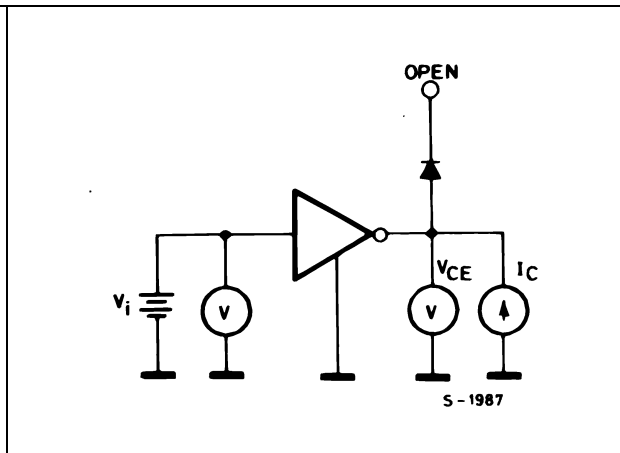

Figure 9. Clamp diode leakage current

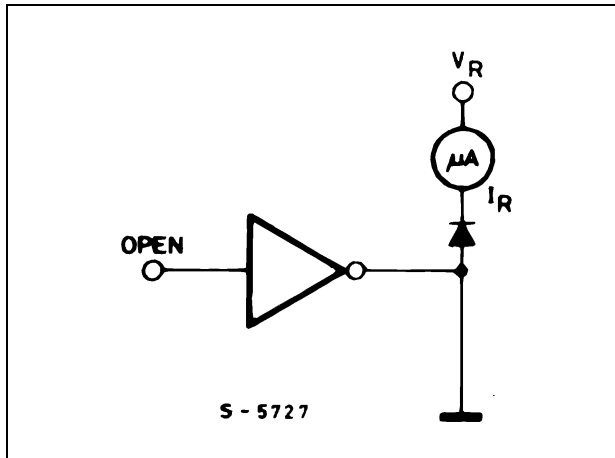
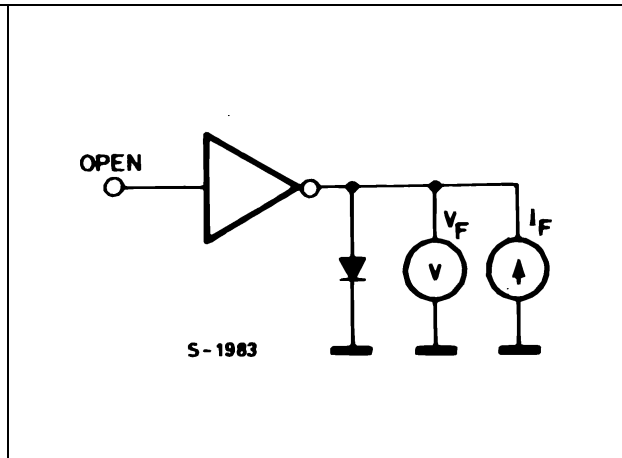

Figure 10. Clamp diode forward voltage



6 Package mechanical data

In order to meet environmental requirements, ST offers these devices in different grades of ECOPACK[®] packages, depending on their level of environmental compliance. ECOPACK[®] specifications, grade definitions and product status are available at: www.st.com. ECOPACK[®] is an ST trademark.

Plastic DIP-16 (0.25) mechanical data

Dim.	mm.			inch.		
	Min.	Typ.	Max.	Min.	Typ.	Max.
a1	0.51			0.020		
B	0.77		1.65	0.030		0.065
b		0.5			0.020	
b1		0.25			0.010	
D			20			0.787
E		8.5			0.335	
e		2.54			0.100	
e3		17.78			0.700	
F			7.1			0.280
I			5.1			0.201
L		3.3			0.130	
Z			1.27			0.050

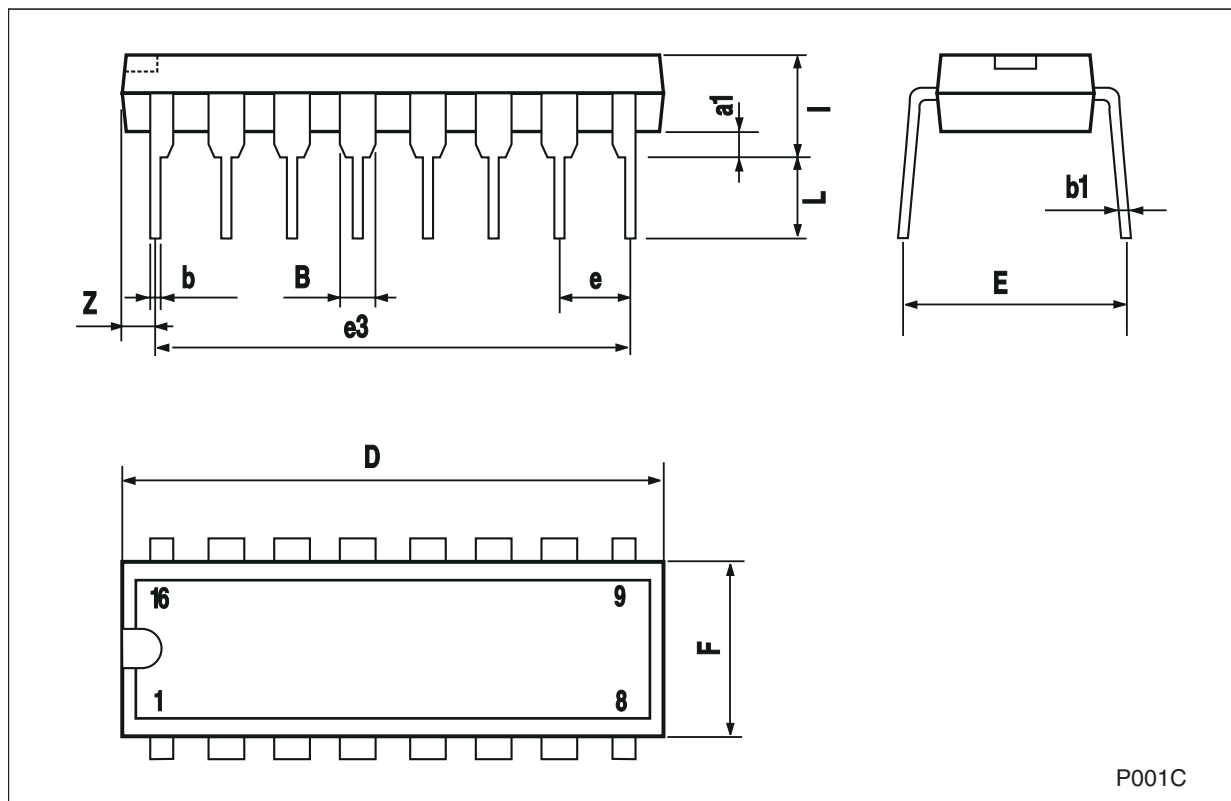

DIM.	mm			inch		
	MIN.	TYP.	MAX.	MIN.	TYP.	MAX.
A			1.75			0.069
a1	0.1		0.25	0.004		0.009
a2			1.6			0.063
b	0.35		0.46	0.014		0.018
b1	0.19		0.25	0.007		0.010
C		0.5			0.020	
c1			45°	(typ.)		
D ⁽¹⁾	9.8		10	0.386		0.394
E	5.8		6.2	0.228		0.244
e		1.27			0.050	
e3		8.89			0.350	
F ⁽¹⁾	3.8		4.0	0.150		0.157
G	4.60		5.30	0.181		0.208
L	0.4		1.27	0.150		0.050
M			0.62			0.024
S	8 ° (max.)					
(1) "D" and "F" do not include mold flash or protrusions - Mold flash or protrusions shall not exceed 0.15mm (.006inc.)						

OUTLINE AND MECHANICAL DATA

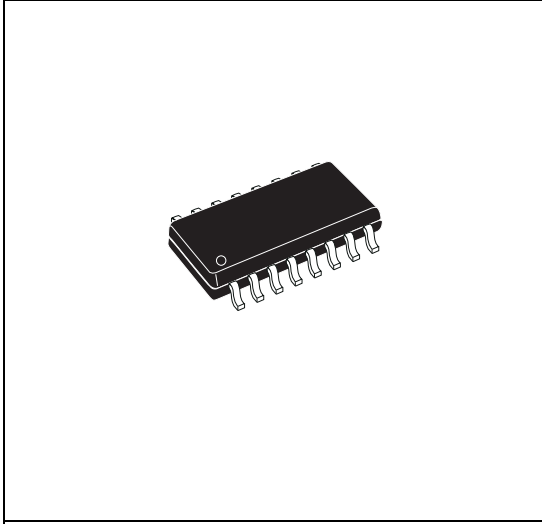

SO16 (Narrow)

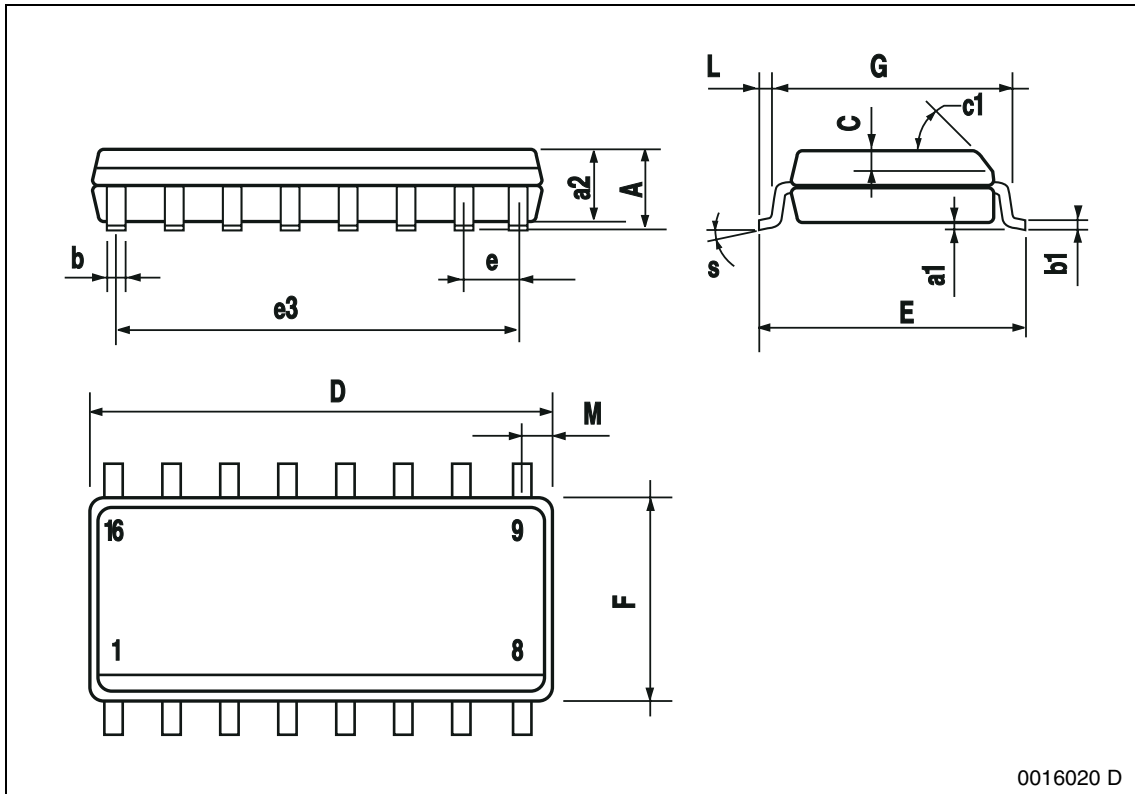

0016020 D

7 Revision history

Table 6. Document revision history

Date	Revision	Changes
05-Dec-2006	2	Order codes updated.
23-May-2007	3	Order codes updated.
17-Apr-2008	4	Added new order codes for Automotive grade products see Table 1 on page 1 .
25-Aug-2008	5	Modified: Table 4 on page 6 and Table 5 on page 7 .
11-Feb-2011	6	Modified: $T_J = -25$ to 105 °C Table 4 on page 6 .

Please Read Carefully:

Information in this document is provided solely in connection with ST products. STMicroelectronics NV and its subsidiaries ("ST") reserve the right to make changes, corrections, modifications or improvements, to this document, and the products and services described herein at any time, without notice.

All ST products are sold pursuant to ST's terms and conditions of sale.

Purchasers are solely responsible for the choice, selection and use of the ST products and services described herein, and ST assumes no liability whatsoever relating to the choice, selection or use of the ST products and services described herein.

No license, express or implied, by estoppel or otherwise, to any intellectual property rights is granted under this document. If any part of this document refers to any third party products or services it shall not be deemed a license grant by ST for the use of such third party products or services, or any intellectual property contained therein or considered as a warranty covering the use in any manner whatsoever of such third party products or services or any intellectual property contained therein.

UNLESS OTHERWISE SET FORTH IN ST'S TERMS AND CONDITIONS OF SALE ST DISCLAIMS ANY EXPRESS OR IMPLIED WARRANTY WITH RESPECT TO THE USE AND/OR SALE OF ST PRODUCTS INCLUDING WITHOUT LIMITATION IMPLIED WARRANTIES OF MERCHANTABILITY, FITNESS FOR A PARTICULAR PURPOSE (AND THEIR EQUIVALENTS UNDER THE LAWS OF ANY JURISDICTION), OR INFRINGEMENT OF ANY PATENT, COPYRIGHT OR OTHER INTELLECTUAL PROPERTY RIGHT.

UNLESS EXPRESSLY APPROVED IN WRITING BY AN AUTHORIZED ST REPRESENTATIVE, ST PRODUCTS ARE NOT RECOMMENDED, AUTHORIZED OR WARRANTED FOR USE IN MILITARY, AIR CRAFT, SPACE, LIFE SAVING, OR LIFE SUSTAINING APPLICATIONS, NOR IN PRODUCTS OR SYSTEMS WHERE FAILURE OR MALFUNCTION MAY RESULT IN PERSONAL INJURY, DEATH, OR SEVERE PROPERTY OR ENVIRONMENTAL DAMAGE. ST PRODUCTS WHICH ARE NOT SPECIFIED AS "AUTOMOTIVE GRADE" MAY ONLY BE USED IN AUTOMOTIVE APPLICATIONS AT USER'S OWN RISK.

Resale of ST products with provisions different from the statements and/or technical features set forth in this document shall immediately void any warranty granted by ST for the ST product or service described herein and shall not create or extend in any manner whatsoever, any liability of ST.

ST and the ST logo are trademarks or registered trademarks of ST in various countries.

Information in this document supersedes and replaces all information previously supplied.

The ST logo is a registered trademark of STMicroelectronics. All other names are the property of their respective owners.

© 2011 STMicroelectronics - All rights reserved

STMicroelectronics group of companies

Australia - Belgium - Brazil - Canada - China - Czech Republic - Finland - France - Germany - Hong Kong - India - Israel - Italy - Japan - Malaysia - Malta - Morocco - Philippines - Singapore - Spain - Sweden - Switzerland - United Kingdom - United States of America

www.st.com

Looking for pricing, stock, or lifecycle information?

Click below to explore more details on WIN SOURCE:

- ⊖ [View ULQ2001D1013TR on WIN SOURCE](#)
- ⊖ [STMicroelectronics Information](#)

Optimize Your Supply Chain with WIN SOURCE Solutions

- ✓ Global Sourcing Solution
- ✓ Obsolete Management
- ✓ Cost Control Management
- ✓ Shortage Management
- ✓ Alternative Solution
- ✓ Excess Inventory Management