



**THE DATASHEET OF  
MMZ1608R601ATD25**



## Chip beads

For general signal line

MMZ series (for automotive)



AEC-Q200

## MMZ1608 type



## FEATURES

- Noise reduction solution for general signal line.
- Various frequency characteristics with 8 materials of different features for countermeasures against everything from general signals to high-speed signals.
- Operating temperature range: -55 to +125°C
- Compliant with AEC-Q200

## APPLICATION

- Various ECUs, powertrains, body controls, and car multimedia (telematics).

## PART NUMBER CONSTRUCTION

MMZ	1608	B	121	C	T	DH5
Series name	LxWxT dimensions 1.6x0.8x0.6 mm 1.6x0.8x0.8 mm	Material name	Impedance ( $\Omega$ ) at 100MHz	Characteristic type	Packaging style	Internal code

## CHARACTERISTICS SPECIFICATION TABLE

Impedance [100MHz] ( $\Omega$ )	DC resistance ( $\Omega$ )max.	Rated current (mA)max.	Thickness T (mm)	Part No.	
120	$\pm 25\%$	0.15	600	0.6	<a href="#">MMZ1608B121CTDH5</a>
220	$\pm 25\%$	0.25	500	0.6	<a href="#">MMZ1608B221CTDH5</a>
300	$\pm 25\%$	0.25	500	0.6	<a href="#">MMZ1608B301CTDH5</a>
470	$\pm 25\%$	0.30	500	0.6	<a href="#">MMZ1608B471CTDH5</a>
600	$\pm 25\%$	0.40	500	0.6	<a href="#">MMZ1608B601CTDH5</a>
1000	$\pm 25\%$	0.60	300	0.8	<a href="#">MMZ1608B102CTD25</a>
15	$\pm 25\%$	0.05	1500	0.8	<a href="#">MMZ1608R150ATD25</a>
30	$\pm 25\%$	0.05	1500	0.8	<a href="#">MMZ1608R300ATD25</a>
60	$\pm 25\%$	0.10	800	0.8	<a href="#">MMZ1608R600ATD25</a>
120	$\pm 25\%$	0.18	500	0.8	<a href="#">MMZ1608R121ATD25</a>
300	$\pm 25\%$	0.25	500	0.8	<a href="#">MMZ1608R301ATD25</a>
470	$\pm 25\%$	0.30	500	0.8	<a href="#">MMZ1608R471ATD25</a>
600	$\pm 25\%$	0.40	500	0.8	<a href="#">MMZ1608R601ATD25</a>
1000	$\pm 25\%$	0.50	400	0.8	<a href="#">MMZ1608R102ATD25</a>

## Measurement equipment

Measurement item	Product No.	Manufacturer
Impedance	E4991A+16192A	Keysight Technologies
DC resistance	Type-7556	Yokogawa

\* Equivalent measurement equipment may be used.

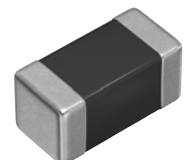

## MMZ1608 type

## CHARACTERISTICS SPECIFICATION TABLE

Impedance [100MHz] ( $\Omega$ )		DC resistance ( $\Omega$ )max.	Rated current (mA)max.	Thickness T (mm)	Part No.
Tolerance					
40	±25%	0.10	600	0.8	<a href="#">MMZ1608S400ATD25</a>
80	±25%	0.15	500	0.8	<a href="#">MMZ1608S800ATD25</a>
120	±25%	0.15	500	0.8	<a href="#">MMZ1608S121ATD25</a>
180	±25%	0.20	500	0.8	<a href="#">MMZ1608S181ATD25</a>
220	±25%	0.20	500	0.8	<a href="#">MMZ1608S221ATD25</a>
300	±25%	0.30	500	0.8	<a href="#">MMZ1608S301ATD25</a>
470	±25%	0.30	500	0.8	<a href="#">MMZ1608S471ATD25</a>
600	±25%	0.35	500	0.8	<a href="#">MMZ1608S601ATD25</a>
1000	±25%	0.50	400	0.8	<a href="#">MMZ1608S102ATD25</a>
2000	±25%	0.90	200	0.8	<a href="#">MMZ1608S202ATD25</a>
15	±25%	0.05	1500	0.8	<a href="#">MMZ1608Y150BTD25</a>
30	±25%	0.05	1500	0.8	<a href="#">MMZ1608Y300BTD25</a>
60	±25%	0.15	500	0.8	<a href="#">MMZ1608Y600BTD25</a>
120	±25%	0.20	500	0.8	<a href="#">MMZ1608Y121BTD25</a>
220	±25%	0.30	500	0.8	<a href="#">MMZ1608Y221BTD25</a>
300	±25%	0.30	500	0.8	<a href="#">MMZ1608Y301BTD25</a>
470	±25%	0.35	500	0.8	<a href="#">MMZ1608Y471BTD25</a>
600	±25%	0.40	500	0.8	<a href="#">MMZ1608Y601BTD25</a>
750	±25%	0.45	500	0.8	<a href="#">MMZ1608Y751BTD25</a>
1000	±25%	0.50	400	0.8	<a href="#">MMZ1608Y102BTD25</a>
1500	±25%	0.60	300	0.8	<a href="#">MMZ1608Y152BTD25</a>
1800	±25%	0.80	200	0.8	<a href="#">MMZ1608A182BTD25</a>
2200	±25%	0.80	200	0.8	<a href="#">MMZ1608A222BTD25</a>
2500	±25%	0.80	200	0.8	<a href="#">MMZ1608A252BTD25</a>
120	±25%	0.30	500	0.8	<a href="#">MMZ1608Q121BTD25</a>
220	±25%	0.40	500	0.8	<a href="#">MMZ1608Q221BTD25</a>
330	±25%	0.50	400	0.8	<a href="#">MMZ1608Q331BTD25</a>
470	±25%	0.70	300	0.8	<a href="#">MMZ1608Q471BTD25</a>
600	±25%	0.80	200	0.8	<a href="#">MMZ1608Q601BTD25</a>
1000	±25%	1.00	200	0.8	<a href="#">MMZ1608Q102BTD25</a>
5	±2 $\Omega$	0.05	700	0.8	<a href="#">MMZ1608D050CTDH5</a>
10	±5 $\Omega$	0.10	500	0.6	<a href="#">MMZ1608D100CTDH5</a>
22	±25%	0.20	500	0.6	<a href="#">MMZ1608D220CTDH5</a>
50	±25%	0.25	500	0.6	<a href="#">MMZ1608D500CTDH5</a>
80	±25%	0.30	500	0.6	<a href="#">MMZ1608D800CTDH5</a>
80	±25%	0.30	500	0.8	<a href="#">MMZ1608D800BTD25</a>
120	±25%	0.30	400	0.6	<a href="#">MMZ1608D121CTDH5</a>
120	±25%	0.30	400	0.8	<a href="#">MMZ1608D121BTD25</a>
240	±25%	0.60	300	0.8	<a href="#">MMZ1608D241CTD25</a>
300	±25%	0.70	300	0.8	<a href="#">MMZ1608D301BTD25</a>
3typ.		0.05	700	0.8	<a href="#">MMZ1608F030BTD25</a>
47	±25%	0.40	500	0.8	<a href="#">MMZ1608F470BTD25</a>
75	±25%	0.55	300	0.8	<a href="#">MMZ1608F750BTD25</a>
120	±25%	0.75	200	0.8	<a href="#">MMZ1608F121BTD25</a>

## Measurement equipment

Measurement item	Product No.	Manufacturer
Impedance	E4991A+16192A	Keysight Technologies
DC resistance	Type-7556	Yokogawa

\* Equivalent measurement equipment may be used.

# MMZ1608 type

## Z VS. FREQUENCY CHARACTERISTICS (BY SERIES)

**MMZ1608B series**



**MMZ1608R series**



**MMZ1608S series**



**MMZ1608Y series**



**MMZ1608A series**



**MMZ1608Q series**



**MMZ1608D series**



**MMZ1608F series**

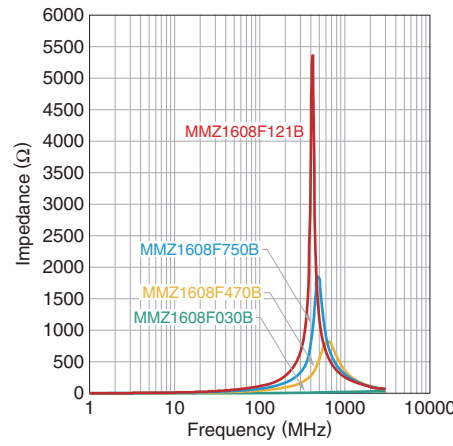

⚠ Please be sure to request delivery specifications that provide further details on the features and specifications of the products for proper and safe use. Please note that the contents may change without any prior notice due to reasons such as upgrading.

# MMZ1608 type

## Z, X, R VS. FREQUENCY CHARACTERISTICS

MMZ1608B121CTDH5



MMZ1608B221CTDH5

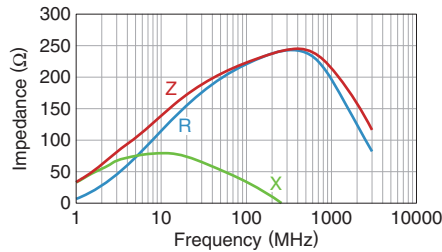

MMZ1608B301CTDH5



MMZ1608B471CTDH5



MMZ1608B601CTDH5

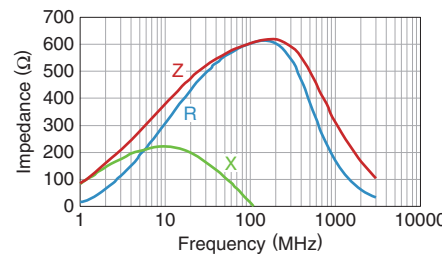

MMZ1608B102CTD25



MMZ1608R150ATD25



MMZ1608R300ATD25



MMZ1608R600ATD25



MMZ1608R121ATD25



MMZ1608R301ATD25

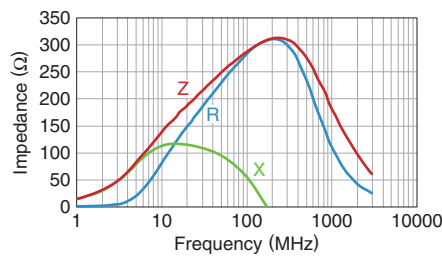

MMZ1608R471ATD25



MMZ1608R601ATD25

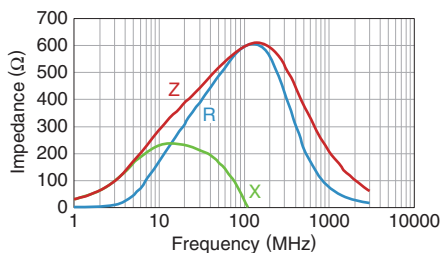

MMZ1608R102ATD25

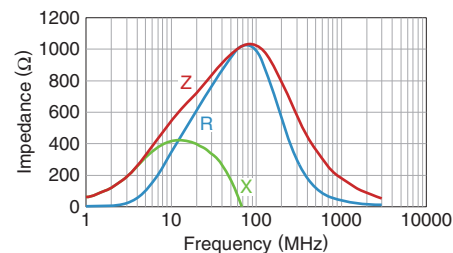

MMZ1608S400ATD25

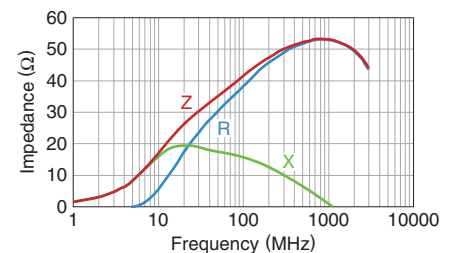

# MMZ1608 type

## Z, X, R VS. FREQUENCY CHARACTERISTICS

MMZ1608S800ATD25

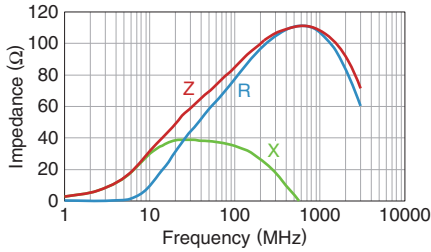

MMZ1608S121ATD25

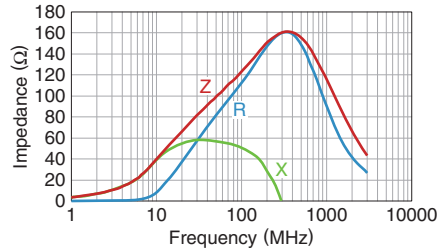

MMZ1608S181ATD25

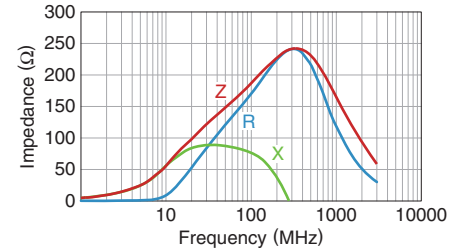

MMZ1608S221ATD25

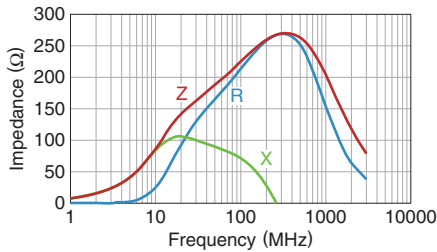

MMZ1608S301ATD25

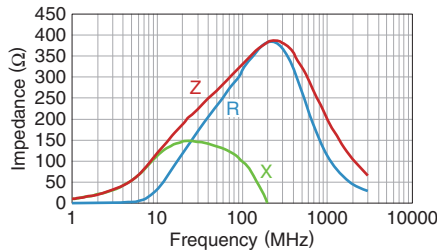

MMZ1608S471ATD25

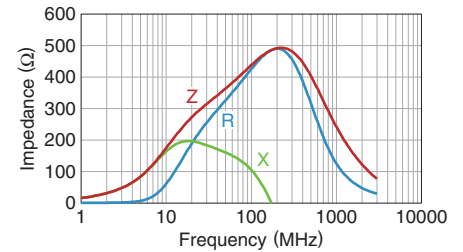

MMZ1608S601ATD25

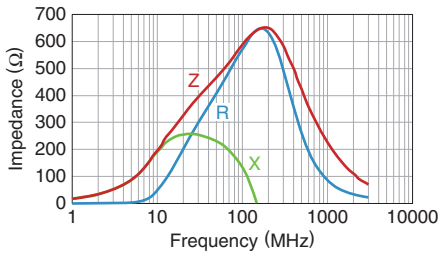

MMZ1608S102ATD25

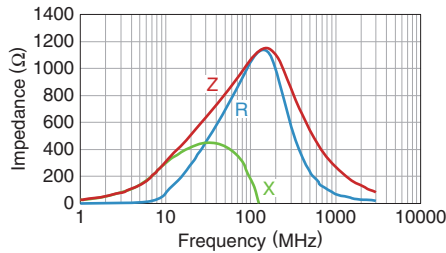

MMZ1608S202ATD25

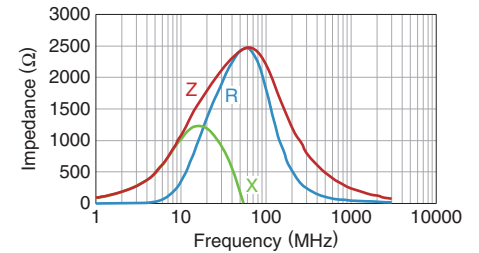

MMZ1608Y150BTD25

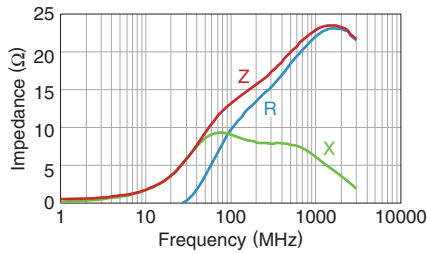

MMZ1608Y300BTD25

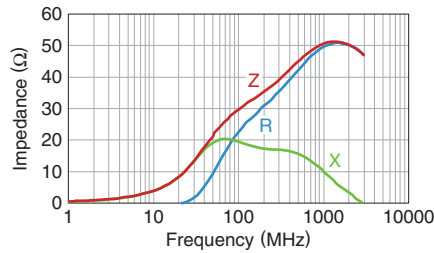

MMZ1608Y600BTD25

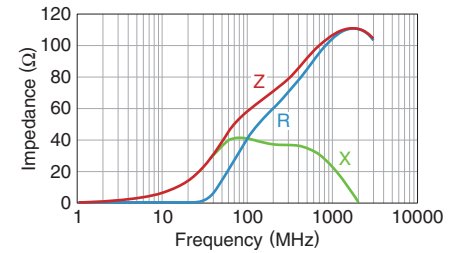

MMZ1608Y121BTD25

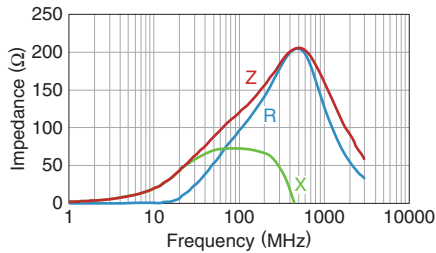

MMZ1608Y221BTD25

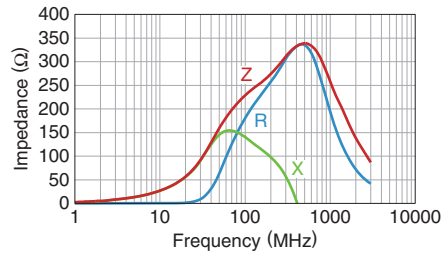

MMZ1608Y301BTD25

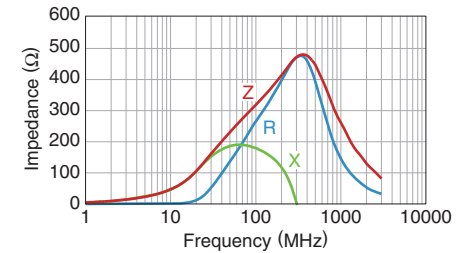

# MMZ1608 type

## Z, X, R VS. FREQUENCY CHARACTERISTICS

**MMZ1608Y471BTD25**

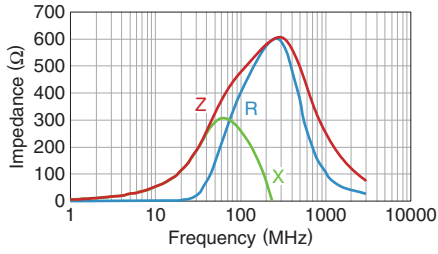

**MMZ1608Y601BTD25**

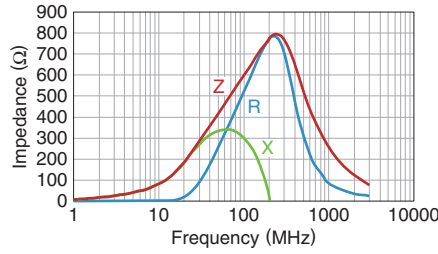

**MMZ1608Y751BTD25**

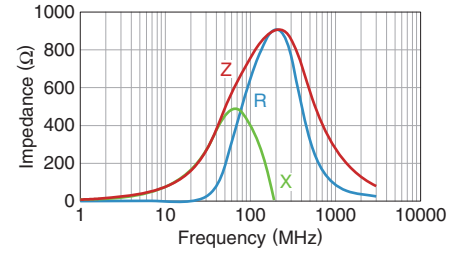

**MMZ1608Y102BTD25**

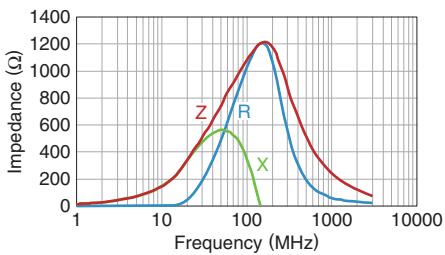

**MMZ1608Y152BTD25**



**MMZ1608A182BTD25**

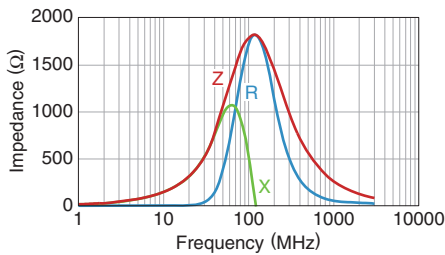

**MMZ1608A222BTD25**

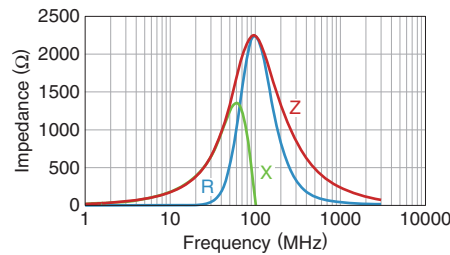

**MMZ1608A252BTD25**

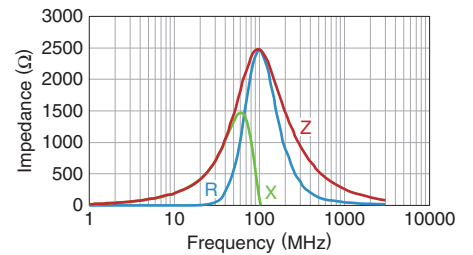

**MMZ1608Q121BTD25**

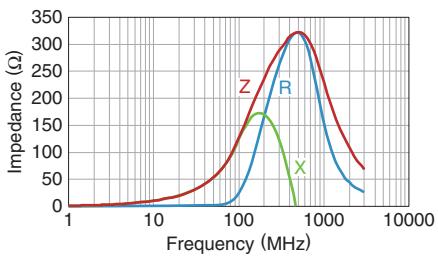

**MMZ1608Q221BTD25**

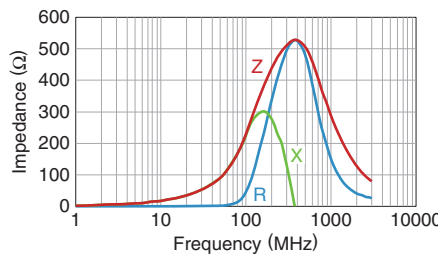

**MMZ1608Q331BTD25**

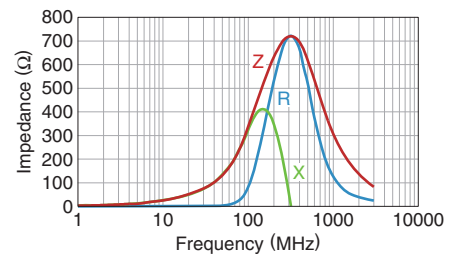

**MMZ1608Q471BTD25**

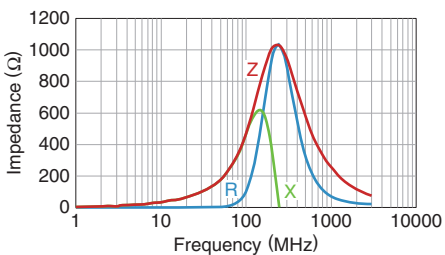

**MMZ1608Q601BTD25**

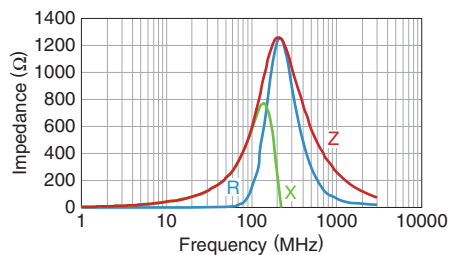

**MMZ1608Q102BTD25**

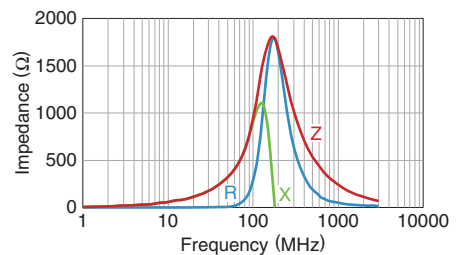

⚠ Please be sure to request delivery specifications that provide further details on the features and specifications of the products for proper and safe use. (6/9)  
Please note that the contents may change without any prior notice due to reasons such as upgrading.

# MMZ1608 type

## Z, X, R VS. FREQUENCY CHARACTERISTICS

MMZ1608D050CTD25

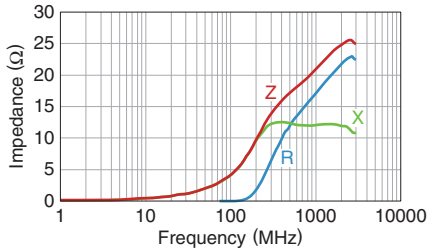

MMZ1608D100CTDH5



MMZ1608D220CTDH5

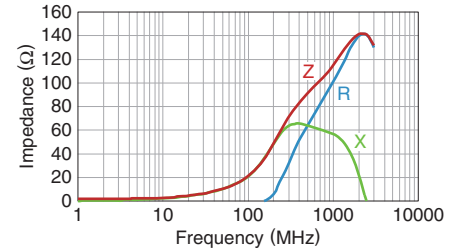

MMZ1608D500CTDH5

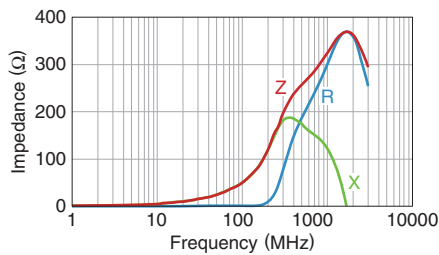

MMZ1608D800CTDH5

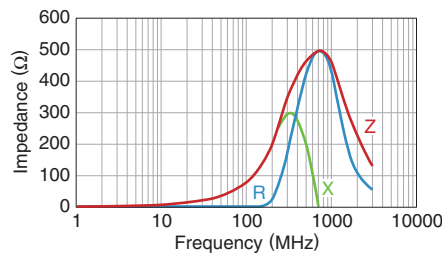

MMZ1608D800BTD25

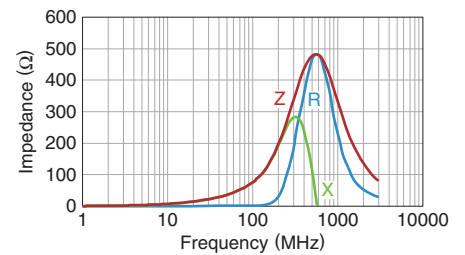

MMZ1608D121CTDH5

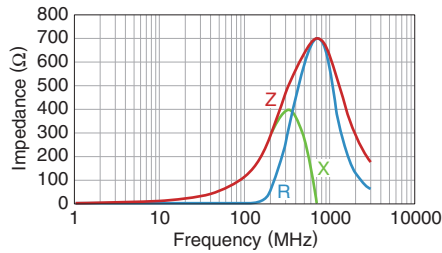

MMZ1608D121BTD25

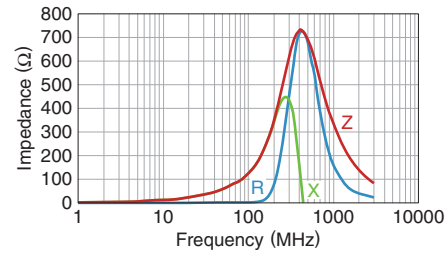

MMZ1608D241CTD25

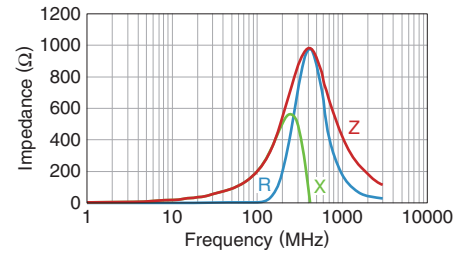

MMZ1608D301BTD25

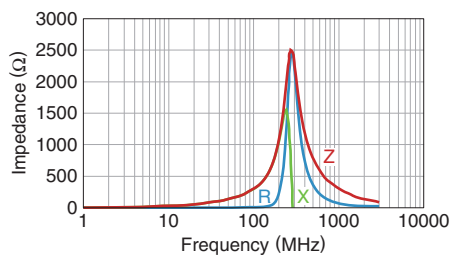

MMZ1608F030BTD25

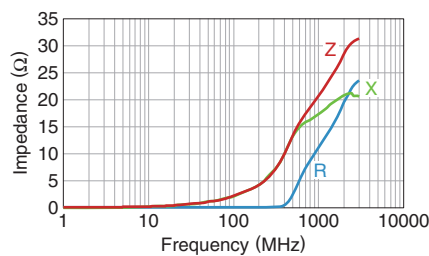

MMZ1608F470BTD25

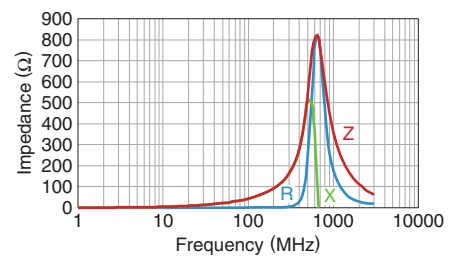

MMZ1608F750BTD25



MMZ1608F121BTD25

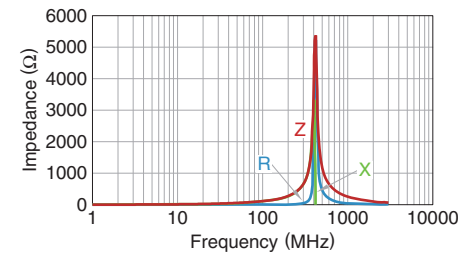

# MMZ1608 type

## SHAPE & DIMENSIONS

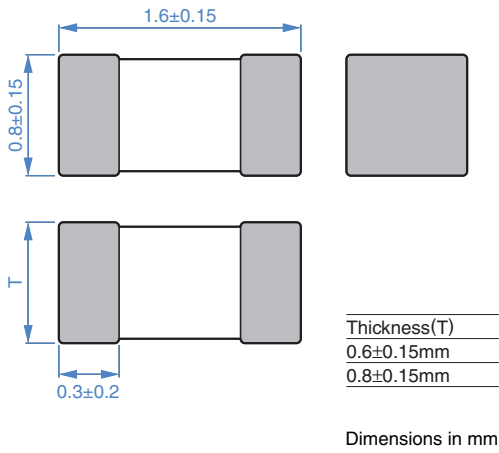

## PACKAGING STYLE

### REEL DIMENSIONS

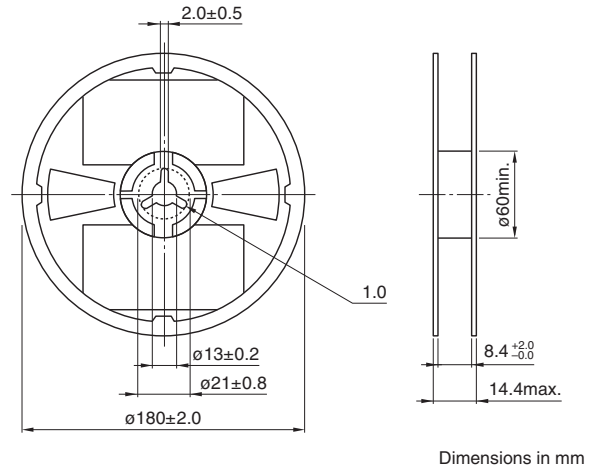

## RECOMMENDED LAND PATTERN

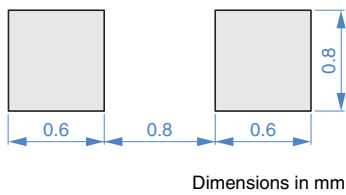

### TAPE DIMENSIONS

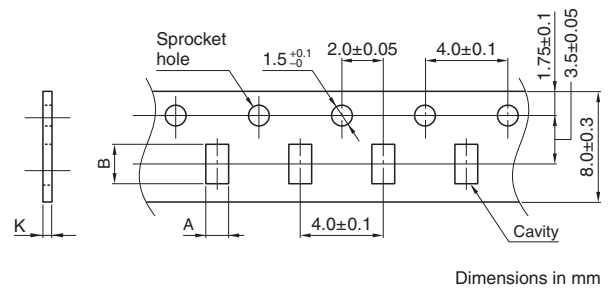

## RECOMMENDED REFLOW PROFILE

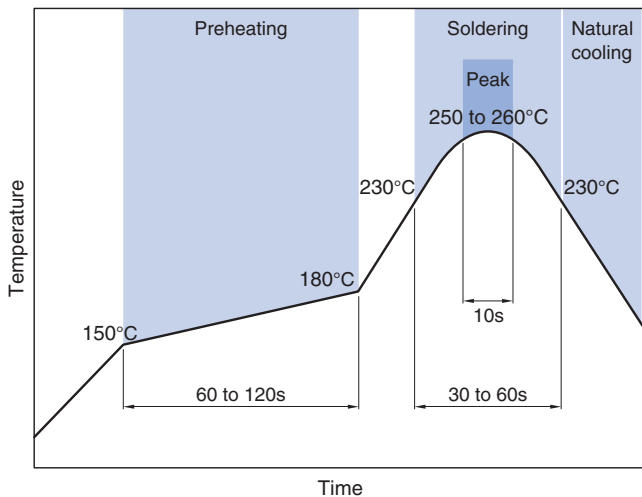

Type	A	B	K
MMZ1608	1.1±0.2	1.9±0.2	1.1max.

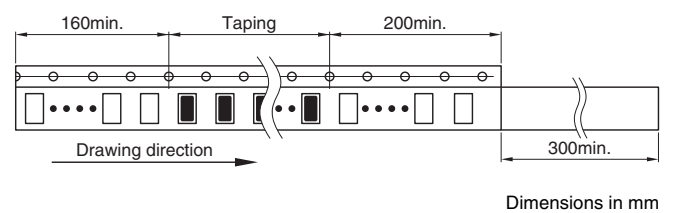

### PACKAGE QUANTITY

Package quantity	4,000 pcs/reel
------------------	----------------

## TEMPERATURE RANGE, INDIVIDUAL WEIGHT

Type	Operating temperature range	Storage temperature range*	Individual weight
t=0.6mm	-55 to +125°C	-55 to +125°C	3 mg
t=0.8mm	-55 to +125°C	-55 to +125°C	4 mg

\* The storage temperature range is for after the assembly.

## REMINDERS FOR USING THESE PRODUCTS

Before using these products, be sure to request the delivery specifications.

### SAFETY REMINDERS

Please pay sufficient attention to the warnings for safe designing when using this products.

#### REMINDERS

- The storage period is within 12 months. Be sure to follow the storage conditions (temperature: 5 to 40°C, humidity: 10 to 75% RH or less).  
If the storage period elapses, the soldering of the terminal electrodes may deteriorate.
- Do not use or store in locations where there are conditions such as gas corrosion (salt, acid, alkali, etc.).
- Before soldering, be sure to preheat components.  
The preheating temperature should be set so that the temperature difference between the solder temperature and chip temperature does not exceed 150°C.
- Soldering corrections after mounting should be within the range of the conditions determined in the specifications.  
If overheated, a short circuit, performance deterioration, or lifespan shortening may occur.
- When embedding a printed circuit board where a chip is mounted to a set, be sure that residual stress is not given to the chip due to the overall distortion of the printed circuit board and partial distortion such as at screw tightening portions.
- Self heating (temperature increase) occurs when the power is turned ON, so the tolerance should be sufficient for the set thermal design.
- Carefully lay out the coil for the circuit board design of the non-magnetic shield type.  
A malfunction may occur due to magnetic interference.
- Use a wrist band to discharge static electricity in your body through the grounding wire.
- Do not expose the products to magnets or magnetic fields.
- Do not use for a purpose outside of the contents regulated in the delivery specifications.
- The products listed on this catalog are intended for use in general electronic equipment (AV equipment, telecommunications equipment, home appliances, amusement equipment, computer equipment, personal equipment, office equipment, measurement equipment, industrial robots) under a normal operation and use condition.  
The products are not designed or warranted to meet the requirements of the applications listed below, whose performance and/or quality require a more stringent level of safety or reliability, or whose failure, malfunction or trouble could cause serious damage to society, person or property.  
If you intend to use the products in the applications listed below or if you have special requirements exceeding the range or conditions set forth in the each catalog, please contact us.

- (1) Aerospace/aviation equipment
- (2) Transportation equipment (electric trains, ships, etc.)
- (3) Medical equipment
- (4) Power-generation control equipment
- (5) Atomic energy-related equipment
- (6) Seabed equipment
- (7) Transportation control equipment

- (8) Public information-processing equipment
- (9) Military equipment
- (10) Electric heating apparatus, burning equipment
- (11) Disaster prevention/crime prevention equipment
- (12) Safety equipment
- (13) Other applications that are not considered general-purpose applications

When designing your equipment even for general-purpose applications, you are kindly requested to take into consideration securing protection circuit/device or providing backup circuits in your equipment.

## Looking for pricing, stock, or lifecycle information?

Click below to explore more details on WIN SOURCE:

- ⊖ [View MMZ1608R601ATD25 on WIN SOURCE](#)
- ⊖ [TDK Corporation Information](#)

## Optimize Your Supply Chain with WIN SOURCE Solutions

- ✓ Global Sourcing Solution
- ✓ Obsolete Management
- ✓ Cost Control Management
- ✓ Shortage Management
- ✓ Alternative Solution
- ✓ Excess Inventory Management