



**THE DATASHEET OF  
TPS22963CZPR**



# TPS2296xC 5.5-V, 3-A, 13-mΩ On-Resistance Load Switch With Reverse Current Protection and Controlled Turn-On

## 1 Features

- Integrated N-Channel Load Switch
- Input Voltage Range: 1 V to 5.5 V
- Internal Pass-FET  $R_{\text{DS(ON)}} = 8 \text{ m}\Omega$  (Typ)
- Ultra-Low ON-Resistance
  - $R_{\text{ON}} = 13 \text{ m}\Omega$  (Typ) at  $V_{\text{IN}} = 5 \text{ V}$
  - $R_{\text{ON}} = 14 \text{ m}\Omega$  (Typ) at  $V_{\text{IN}} = 3.3 \text{ V}$
  - $R_{\text{ON}} = 18 \text{ m}\Omega$  (Typ) at  $V_{\text{IN}} = 1.8 \text{ V}$
- 3A Maximum Continuous Switch Current
- Reverse Current Protection (When Disabled)
- Low Shutdown Current (760 nA)
- Low Threshold 1.3-V GPIO Control Input
- Controlled Slew-Rate to Avoid Inrush Current
- Quick Output Discharge (TPS22964 only)
- Six Terminal Wafer-Chip-Scale Package (Nominal Dimensions Shown - See Addendum for Details)
  - 0.9 mm x 1.4 mm, 0.5 mm Pitch, 0.5 mm Height (YZP)
- ESD Performance Tested Per JESD 22
  - 2-kV Human-Body Model (A114-B, Class II)
  - 500-V Charged-Device Model (C101)

## 2 Applications

- Smartphones
- Notebook Computer and Ultrabook™
- Tablet PC Computer
- Solid State Drives (SSD)
- DTV/IP Set Top Box
- POS Terminals and Media Gateways

## 4 Simplified Schematic

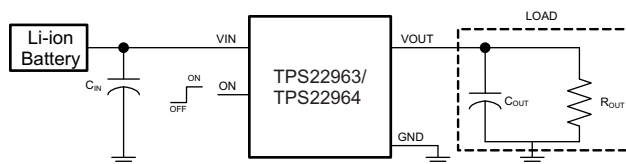

## 3 Description

The TPS22963/64 is a small, ultra-low  $R_{\text{ON}}$  load switch with controlled turn on. The device contains a low  $R_{\text{DS(ON)}}$  N-Channel MOSFET that can operate over an input voltage range of 1 V to 5.5 V and switch currents of up to 3 A. An integrated charge pump biases the NMOS switch in order to achieve a low switch ON-Resistance. The switch is controlled by an on/off input (ON), which is capable of interfacing directly with low-voltage GPIO control signals. The rise time of the TPS22963/64 device is internally controlled in order to avoid inrush current.

The TPS22963/64 provides reverse current protection. When the power switch is disabled, the device will not allow the flow of current towards the input side of the switch. The reverse current protection feature is active only when the device is disabled so as to allow for intentional reverse current (when the switch is enabled) for some applications.

The TPS22963/64 is available in a small, space-saving 6-pin WCSP package and is characterized for operation over the free air temperature range of  $-40^{\circ}\text{C}$  to  $85^{\circ}\text{C}$ .

### Device Information<sup>(1)</sup>

PART NUMBER	PACKAGE	BODY SIZE (NOM)
TPS2296xC	DSBGA (6)	1.40 mm x 0.90 mm

(1) For all available packages, see the orderable addendum at the end of the datasheet.



## Table of Contents

<b>1</b>	<b>Features</b> .....	<b>1</b>	<b>10</b>	<b>Detailed Description</b> .....	<b>14</b>
<b>2</b>	<b>Applications</b> .....	<b>1</b>	10.1	Overview .....	14
<b>3</b>	<b>Description</b> .....	<b>1</b>	10.2	Functional Block Diagram .....	14
<b>4</b>	<b>Simplified Schematic</b> .....	<b>1</b>	10.3	Feature Description .....	15
<b>5</b>	<b>Revision History</b> .....	<b>2</b>	10.4	Device Functional Modes .....	15
<b>6</b>	<b>Device Comparison Table</b> .....	<b>3</b>	<b>11</b>	<b>Application and Implementation</b> .....	<b>15</b>
<b>7</b>	<b>Pin Configuration and Functions</b> .....	<b>3</b>	11.1	Application Information .....	15
<b>8</b>	<b>Specifications</b> .....	<b>4</b>	11.2	Typical Application .....	17
8.1	Absolute Maximum Ratings .....	4	<b>12</b>	<b>Power Supply Recommendations</b> .....	<b>19</b>
8.2	ESD Ratings .....	4	<b>13</b>	<b>Layout</b> .....	<b>19</b>
8.3	Recommended Operating Conditions .....	4	13.1	Layout Guidelines .....	19
8.4	Thermal Information .....	4	13.2	Layout Example .....	19
8.5	Electrical Characteristics .....	5	<b>14</b>	<b>Device and Documentation Support</b> .....	<b>20</b>
8.6	Switching Characteristics .....	6	14.1	Related Links .....	20
8.7	Typical Electrical Characteristics .....	7	14.2	Trademarks .....	20
8.8	Typical Switching Characteristics .....	9	14.3	Electrostatic Discharge Caution .....	20
8.9	Typical AC Scope Captures at $T_A = 25^\circ\text{C}$ .....	10	14.4	Glossary .....	20
<b>9</b>	<b>Parametric Measurement Information</b> .....	<b>13</b>	<b>15</b>	<b>Mechanical, Packaging, and Orderable Information</b> .....	<b>20</b>

## 5 Revision History

### Changes from Original (June 2013) to Revision A

Page

- Added *Pin Configuration and Functions* section, *ESD Ratings* table, *Feature Description* section, *Device Functional Modes*, *Application and Implementation* section, *Power Supply Recommendations* section, *Layout* section, *Device and Documentation Support* section, and *Mechanical, Packaging, and Orderable Information* section ..... **1**

## 6 Device Comparison Table

	$R_{ON}$ (Typ) at 3.3 V	Rise Time (Typ) at 3.3 V <sup>(1)</sup>	Quick Output Discharge (QOD) <sup>(2)</sup>	Maximum Output Current	Enable
TPS22963C	14 m $\Omega$	715 $\mu$ s	No	3 A	Active High
TPS22964C	14 m $\Omega$	715 $\mu$ s	Yes	3 A	Active High

- (1) Additional rise time options are possible. Contact factory for more information.  
 (2) This feature discharges the output of the switch to ground through a 273  $\Omega$  resistor, preventing the output from floating (only in TPS22964C).

## 7 Pin Configuration and Functions

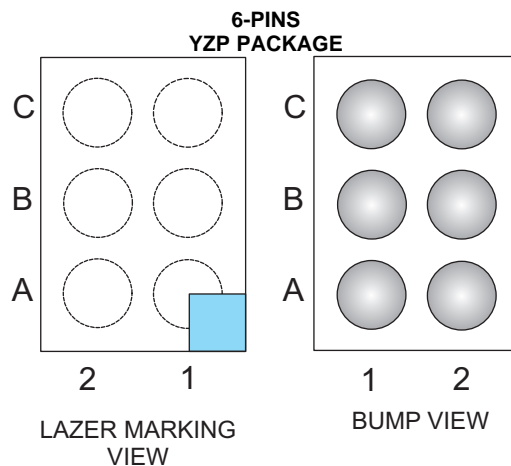

**Pin Assignments (YZP Package)**

<b>C</b>	GND	ON
<b>B</b>	VOUT	VIN
<b>A</b>	VOUT	VIN
	1	2

**Pin Functions**

PIN		I/O	DESCRIPTION
TPS22963/64	NAME		
C1	GND	-	Ground
C2	ON	I	Switch control input, active high. Do not leave floating
A1, B1	VOUT	O	Switch output
A2, B2	VIN	I	Switch input. Use a bypass capacitor to ground (ceramic)

## 8 Specifications

### 8.1 Absolute Maximum Ratings

over operating free-air temperature range (unless otherwise noted)

		MIN	MAX	UNIT
$V_{IN}$	Input voltage range	-0.3	6	V
$V_{OUT}$	Output voltage range	-0.3	6	V
$V_{ON}$	ON pin voltage range	-0.3	6	V
$I_{MAX}$	Maximum continuous switch current		3	A
$I_{PLS}$	Maximum pulsed switch current, 100 $\mu$ s pulse, 2% duty cycle, $T_A = -40^\circ\text{C}$ to $85^\circ\text{C}$		4	A
$T_A$	Operating free air temperature range	-40	85	$^\circ\text{C}$
$T_J$	Maximum junction temperature		125	$^\circ\text{C}$
$T_{stg}$	Storage temperature range	-65	150	$^\circ\text{C}$

### 8.2 ESD Ratings

		VALUE	UNIT
$V_{(ESD)}$	Electrostatic discharge	Human-body model (HBM), per ANSI/ESDA/JEDEC JS-001 <sup>(1)</sup>	$\pm 2000$
		Charged-device model (CDM), per JEDEC specification JESD22-C101 <sup>(2)</sup>	$\pm 500$

- (1) JEDEC document JEP155 states that 500-V HBM allows safe manufacturing with a standard ESD control process. Manufacturing with less than 500-V HBM is possible with the necessary precautions.
- (2) JEDEC document JEP157 states that 250-V CDM allows safe manufacturing with a standard ESD control process. Manufacturing with less than 250-V CDM is possible with the necessary precautions.

### 8.3 Recommended Operating Conditions

over operating free-air temperature range (unless otherwise noted)

		MIN	TYP	MAX	UNIT
$V_{IN}$	Input voltage range	1		5.5	V
$V_{OUT}$	Output voltage range	0		5.5	V
$V_{IH, ON}$	High-level ON voltage	$V_{IN} = 2.5\text{ V to }5.5\text{ V}$	1.3	5.5	V
		$V_{IN} = 1\text{ V to }2.49\text{ V}$	1.1	5.5	
$V_{IL, ON}$	Low-level ON voltage	$V_{IN} = 2.5\text{ V to }5.5\text{ V}$	0	0.6	V
		$V_{IN} = 1\text{ V to }2.49\text{ V}$	0	0.4	
$C_{IN}$	Input capacitor		1 <sup>(1)</sup>		$\mu\text{F}$

- (1) Refer to the application section

### 8.4 Thermal Information

THERMAL METRIC <sup>(1)</sup>		TPS2296xC	UNIT
		YZP	
		6 PINS	
$R_{\theta JA}$	Junction-to-ambient thermal resistance	132.0	$^\circ\text{C/W}$
$R_{\theta Jctop}$	Junction-to-case (top) thermal resistance	1.4	
$R_{\theta JB}$	Junction-to-board thermal resistance	22.8	
$\Psi_{JT}$	Junction-to-top characterization parameter	5.7	
$\Psi_{JB}$	Junction-to-board characterization parameter	22.6	

- (1) For more information about traditional and new thermal metrics, see the *IC Package Thermal Metrics* application report, [SPRA953](http://www.ti.com/lit/an/spra953).

## 8.5 Electrical Characteristics

 $V_{IN} = 1\text{ V to }5.5\text{ V}$ ,  $T_A = -40^\circ\text{C to }85^\circ\text{C}$  (unless otherwise noted)

PARAMETER		TEST CONDITIONS	$T_A$	MIN	TYP	MAX	UNIT
$I_{Q, VIN}$	Quiescent current	$I_{OUT} = 0$ , $V_{ON} = V_{IN} = 5\text{ V}$	Full		66.5	96	$\mu\text{A}$
		$I_{OUT} = 0$ , $V_{ON} = V_{IN} = 4.5\text{ V}$	Full		57	82	
		$I_{OUT} = 0$ , $V_{ON} = V_{IN} = 3.3\text{ V}$	Full		38	60	
		$I_{OUT} = 0$ , $V_{ON} = V_{IN} = 2.5\text{ V}$	Full		33.3	55	
		$I_{OUT} = 0$ , $V_{ON} = V_{IN} = 1.8\text{ V}$	Full		28.3	45	
		$I_{OUT} = 0$ , $V_{ON} = V_{IN} = 1.2\text{ V}$	Full		22.8	36	
		$I_{OUT} = 0$ , $V_{ON} = V_{IN} = 1.1\text{ V}$	Full		21.6	34	
		$I_{OUT} = 0$ , $V_{ON} = V_{IN} = 1\text{ V}$	Full		20.3	33	
$I_{SD, VIN}$	Shut down current	$V_{ON} = 0$ , $V_{IN} = 5\text{ V}$ , $V_{OUT} = 0\text{ V}$	Full		0.76	2	$\mu\text{A}$
		$V_{ON} = 0$ , $V_{IN} = 1\text{ V}$ , $V_{OUT} = 0\text{ V}$	Full		0.07	0.8	
$R_{ON}$	On-resistance	$V_{IN} = 5\text{ V}$ , $I_{OUT} = -200\text{ mA}$	$25^\circ\text{C}$		13.3	21	$\text{m}\Omega$
			Full			26	
		$V_{IN} = 4.5\text{ V}$ , $I_{OUT} = -200\text{ mA}$	$25^\circ\text{C}$		13.3	21	$\text{m}\Omega$
			Full			26	
		$V_{IN} = 3.3\text{ V}$ , $I_{OUT} = -200\text{ mA}$	$25^\circ\text{C}$		13.8	22	$\text{m}\Omega$
			Full			27	
		$V_{IN} = 2.5\text{ V}$ , $I_{OUT} = -200\text{ mA}$	$25^\circ\text{C}$		15.4	24	$\text{m}\Omega$
			Full			29	
		$V_{IN} = 1.8\text{ V}$ , $I_{OUT} = -200\text{ mA}$	$25^\circ\text{C}$		18.2	28	$\text{m}\Omega$
			Full			33	
		$V_{IN} = 1.2\text{ V}$ , $I_{OUT} = -200\text{ mA}$	$25^\circ\text{C}$		25.6	37	$\text{m}\Omega$
			Full			44	
		$V_{IN} = 1.1\text{ V}$ , $I_{OUT} = -200\text{ mA}$	$25^\circ\text{C}$		28.7	41	$\text{m}\Omega$
			Full			50	
		$V_{IN} = 1\text{ V}$ , $I_{OUT} = -200\text{ mA}$	$25^\circ\text{C}$		33.8	48	$\text{m}\Omega$
			Full			60	
$V_{HYS, ON}$	ON pin hysteresis	$V_{IN} = 5\text{ V}$	Full		115	$\text{mV}$	
		$V_{IN} = 4.5\text{ V}$	Full		105		
		$V_{IN} = 3.3\text{ V}$	Full		80		
		$V_{IN} = 2.5\text{ V}$	Full		65		
		$V_{IN} = 1.8\text{ V}$	Full		50		
		$V_{IN} = 1.2\text{ V}$	Full		35		
		$V_{IN} = 1.1\text{ V}$	Full		30		
		$V_{IN} = 1\text{ V}$	Full		30		
$I_{ON}$	ON pin leakage current	$V_{ON} = 1.1\text{ V to }5.5\text{ V}$	Full			150	nA
$I_{RC, VIN}$	Reverse current when disabled	$V_{IN} = V_{ON} = 0\text{ V}$ , $V_{OUT} = 5\text{ V}$	$25^\circ\text{C}$		-0.02		$\mu\text{A}$
			$85^\circ\text{C}$		-2.1		
$R_{PD}^{(1)}$	Output pulldown resistance	$V_{ON} = 0\text{ V}$ , $I_{OUT} = 2\text{ mA}$	Full		273	325	$\Omega$

(1) Available in TPS22964 only.

## 8.6 Switching Characteristics

PARAMETER	TEST CONDITION	TPS22963/64	UNIT
		TYP	
<b><math>V_{IN} = 5.0\text{ V}</math>, <math>T_A = 25^\circ\text{C}</math> (unless otherwise noted)</b>			
$t_{ON}$ Turn-ON time	$R_{OUT} = 10\ \Omega$ , $C_{IN} = 1\ \mu\text{F}$ , $C_{OUT} = 0.1\ \mu\text{F}$	928	$\mu\text{s}$
$t_{OFF}$ Turn-OFF time	$R_{OUT} = 10\ \Omega$ , $C_{IN} = 1\ \mu\text{F}$ , $C_{OUT} = 0.1\ \mu\text{F}$	2.5	
$t_R$ VOUT rise time	$R_{OUT} = 10\ \Omega$ , $C_{IN} = 1\ \mu\text{F}$ , $C_{OUT} = 0.1\ \mu\text{F}$	890	
$t_F$ VOUT fall time	$R_{OUT} = 10\ \Omega$ , $C_{IN} = 1\ \mu\text{F}$ , $C_{OUT} = 0.1\ \mu\text{F}$	2.1	
$t_D$ Delay time	$R_{OUT} = 10\ \Omega$ , $C_{IN} = 1\ \mu\text{F}$ , $C_{OUT} = 0.1\ \mu\text{F}$	561	
<b><math>V_{IN} = 4.5\text{ V}</math>, <math>T_A = 25^\circ\text{C}</math> (unless otherwise noted)</b>			
$t_{ON}$ Turn-ON time	$R_{OUT} = 10\ \Omega$ , $C_{IN} = 1\ \mu\text{F}$ , $C_{OUT} = 0.1\ \mu\text{F}$	905	$\mu\text{s}$
$t_{OFF}$ Turn-OFF time	$R_{OUT} = 10\ \Omega$ , $C_{IN} = 1\ \mu\text{F}$ , $C_{OUT} = 0.1\ \mu\text{F}$	2.6	
$t_R$ VOUT rise time	$R_{OUT} = 10\ \Omega$ , $C_{IN} = 1\ \mu\text{F}$ , $C_{OUT} = 0.1\ \mu\text{F}$	859	
$t_F$ VOUT fall time	$R_{OUT} = 10\ \Omega$ , $C_{IN} = 1\ \mu\text{F}$ , $C_{OUT} = 0.1\ \mu\text{F}$	2.1	
$t_D$ Delay time	$R_{OUT} = 10\ \Omega$ , $C_{IN} = 1\ \mu\text{F}$ , $C_{OUT} = 0.1\ \mu\text{F}$	560	
<b><math>V_{IN} = 3.3\text{ V}</math>, <math>T_A = 25^\circ\text{C}</math> (unless otherwise noted)</b>			
$t_{ON}$ Turn-ON time	$R_{OUT} = 10\ \Omega$ , $C_{IN} = 1\ \mu\text{F}$ , $C_{OUT} = 0.1\ \mu\text{F}$	836	$\mu\text{s}$
$t_{OFF}$ Turn-OFF time	$R_{OUT} = 10\ \Omega$ , $C_{IN} = 1\ \mu\text{F}$ , $C_{OUT} = 0.1\ \mu\text{F}$	2.8	
$t_R$ VOUT rise time	$R_{OUT} = 10\ \Omega$ , $C_{IN} = 1\ \mu\text{F}$ , $C_{OUT} = 0.1\ \mu\text{F}$	715	
$t_F$ VOUT fall time	$R_{OUT} = 10\ \Omega$ , $C_{IN} = 1\ \mu\text{F}$ , $C_{OUT} = 0.1\ \mu\text{F}$	2	
$t_D$ Delay time	$R_{OUT} = 10\ \Omega$ , $C_{IN} = 1\ \mu\text{F}$ , $C_{OUT} = 0.1\ \mu\text{F}$	553	
<b><math>V_{IN} = 1.8\text{ V}</math>, <math>T_A = 25^\circ\text{C}</math> (unless otherwise noted)</b>			
$t_{ON}$ Turn-ON time	$R_{OUT} = 10\ \Omega$ , $C_{IN} = 1\ \mu\text{F}$ , $C_{OUT} = 0.1\ \mu\text{F}$	822	$\mu\text{s}$
$t_{OFF}$ Turn-OFF time	$R_{OUT} = 10\ \Omega$ , $C_{IN} = 1\ \mu\text{F}$ , $C_{OUT} = 0.1\ \mu\text{F}$	2.8	
$t_R$ VOUT rise time	$R_{OUT} = 10\ \Omega$ , $C_{IN} = 1\ \mu\text{F}$ , $C_{OUT} = 0.1\ \mu\text{F}$	651	
$t_F$ VOUT fall time	$R_{OUT} = 10\ \Omega$ , $C_{IN} = 1\ \mu\text{F}$ , $C_{OUT} = 0.1\ \mu\text{F}$	2	
$t_D$ Delay time	$R_{OUT} = 10\ \Omega$ , $C_{IN} = 1\ \mu\text{F}$ , $C_{OUT} = 0.1\ \mu\text{F}$	558	
<b><math>V_{IN} = 1.2\text{ V}</math>, <math>T_A = 25^\circ\text{C}</math> (unless otherwise noted)</b>			
$t_{ON}$ Turn-ON time	$R_{OUT} = 10\ \Omega$ , $C_{IN} = 1\ \mu\text{F}$ , $C_{OUT} = 0.1\ \mu\text{F}$	852	$\mu\text{s}$
$t_{OFF}$ Turn-OFF time	$R_{OUT} = 10\ \Omega$ , $C_{IN} = 1\ \mu\text{F}$ , $C_{OUT} = 0.1\ \mu\text{F}$	3.2	
$t_R$ VOUT rise time	$R_{OUT} = 10\ \Omega$ , $C_{IN} = 1\ \mu\text{F}$ , $C_{OUT} = 0.1\ \mu\text{F}$	535	
$t_F$ VOUT fall time	$R_{OUT} = 10\ \Omega$ , $C_{IN} = 1\ \mu\text{F}$ , $C_{OUT} = 0.1\ \mu\text{F}$	1.8	
$t_D$ Delay time	$R_{OUT} = 10\ \Omega$ , $C_{IN} = 1\ \mu\text{F}$ , $C_{OUT} = 0.1\ \mu\text{F}$	594	
<b><math>V_{IN} = 1.1\text{ V}</math>, <math>T_A = 25^\circ\text{C}</math> (unless otherwise noted)</b>			
$t_{ON}$ Turn-ON time	$R_{OUT} = 10\ \Omega$ , $C_{IN} = 1\ \mu\text{F}$ , $C_{OUT} = 0.1\ \mu\text{F}$	861	$\mu\text{s}$
$t_{OFF}$ Turn-OFF time	$R_{OUT} = 10\ \Omega$ , $C_{IN} = 1\ \mu\text{F}$ , $C_{OUT} = 0.1\ \mu\text{F}$	3.5	
$t_R$ VOUT rise time	$R_{OUT} = 10\ \Omega$ , $C_{IN} = 1\ \mu\text{F}$ , $C_{OUT} = 0.1\ \mu\text{F}$	518	
$t_F$ VOUT fall time	$R_{OUT} = 10\ \Omega$ , $C_{IN} = 1\ \mu\text{F}$ , $C_{OUT} = 0.1\ \mu\text{F}$	1.9	
$t_D$ Delay time	$R_{OUT} = 10\ \Omega$ , $C_{IN} = 1\ \mu\text{F}$ , $C_{OUT} = 0.1\ \mu\text{F}$	604	

### 8.7 Typical Electrical Characteristics

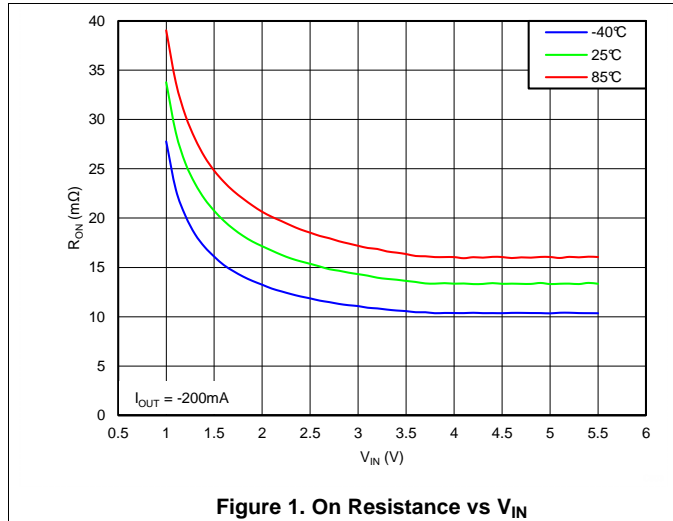

Figure 1. On Resistance vs  $V_{IN}$

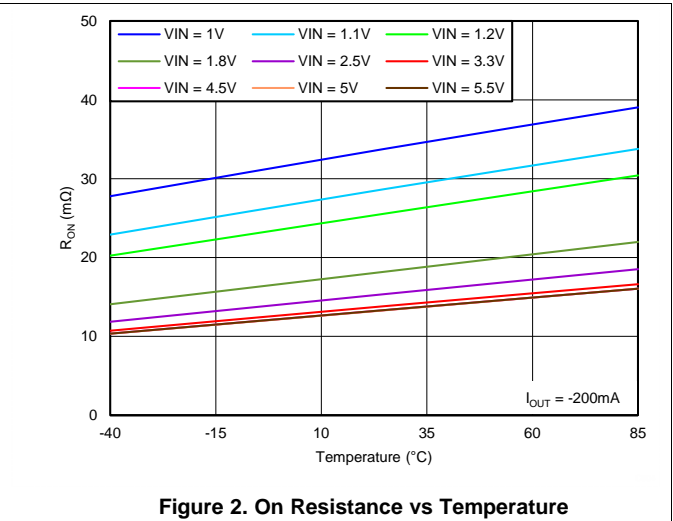

Figure 2. On Resistance vs Temperature

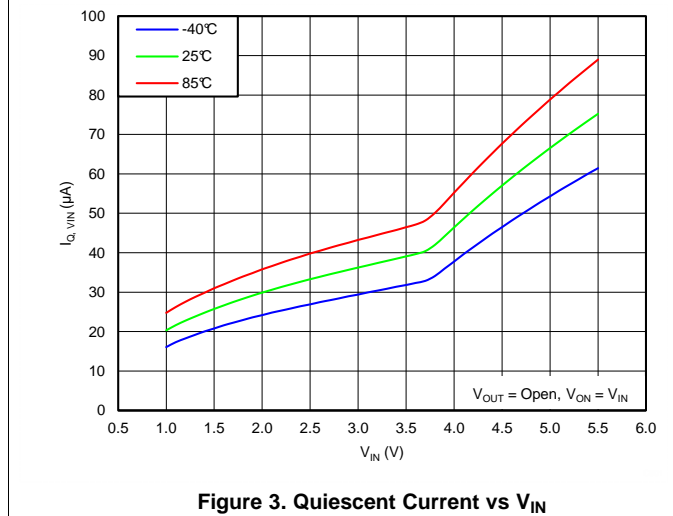

Figure 3. Quiescent Current vs  $V_{IN}$

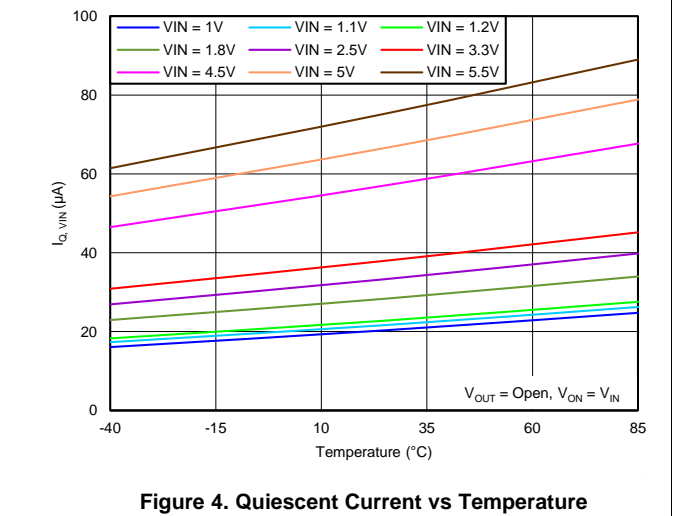

Figure 4. Quiescent Current vs Temperature

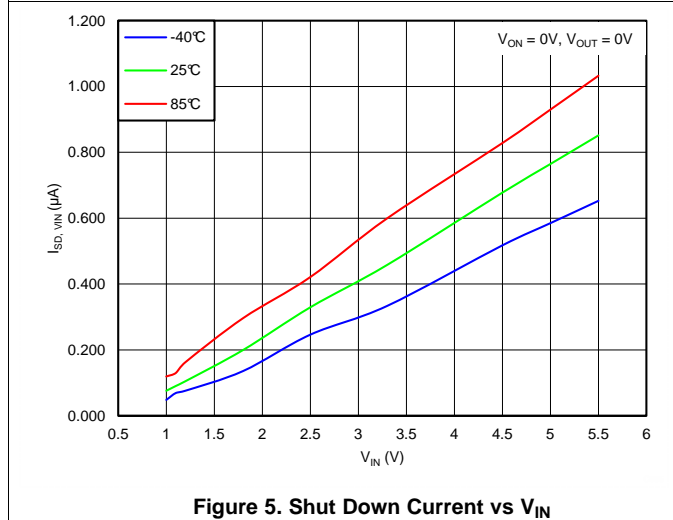

Figure 5. Shut Down Current vs  $V_{IN}$

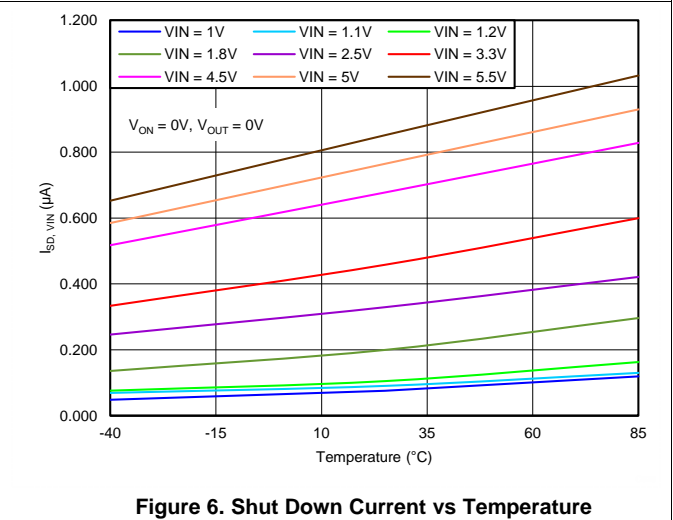

Figure 6. Shut Down Current vs Temperature

Typical Electrical Characteristics (continued)

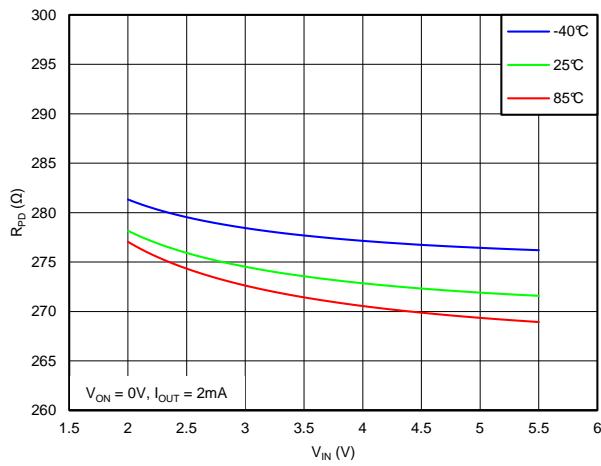

Figure 7. Output Pulldown Resistance vs  $V_{IN}$

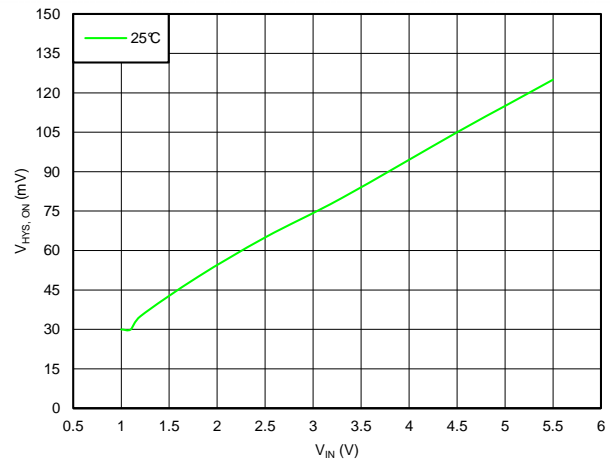

Figure 8. On Pin Hysteresis vs  $V_{IN}$

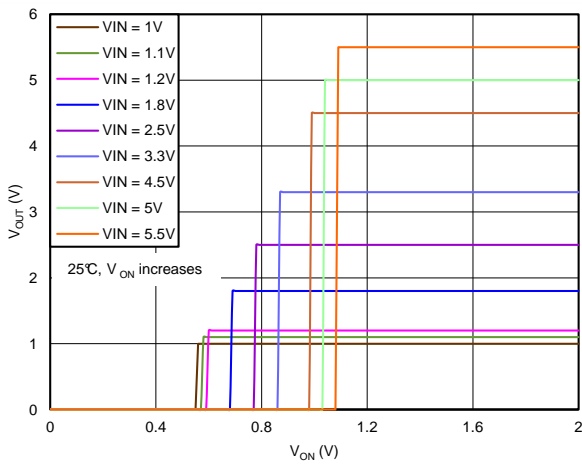

Figure 9. Output Voltage vs  $V_{ON}$  Rising

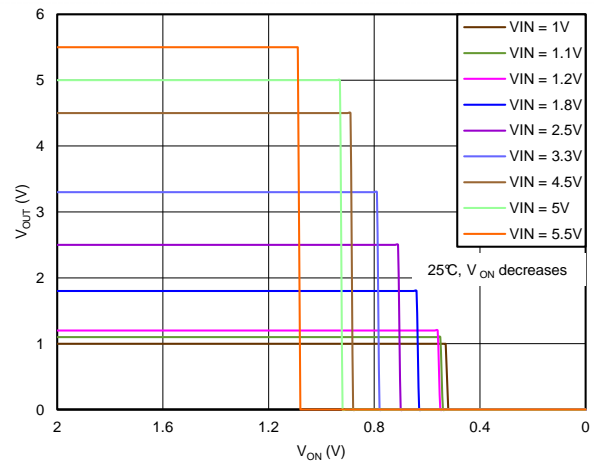

Figure 10. Output Voltage vs  $V_{ON}$  Falling

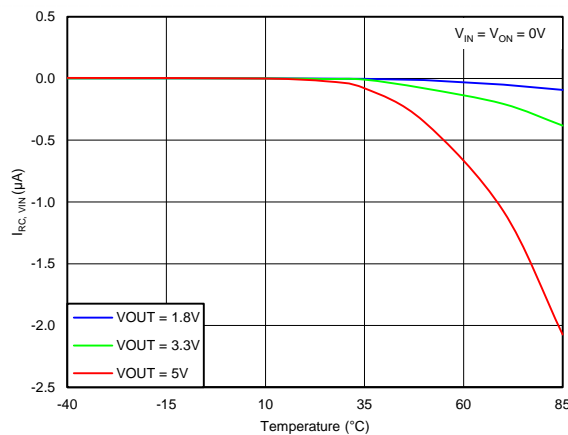

Figure 11. Reverse Current When Disabled vs Temperature

### 8.8 Typical Switching Characteristics

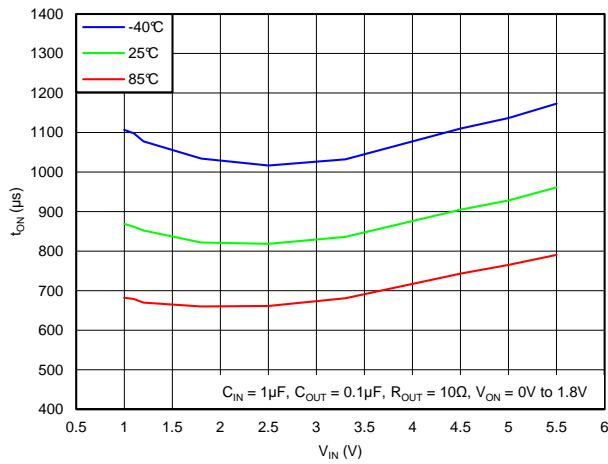

Figure 12. Turn-On Time vs VIN

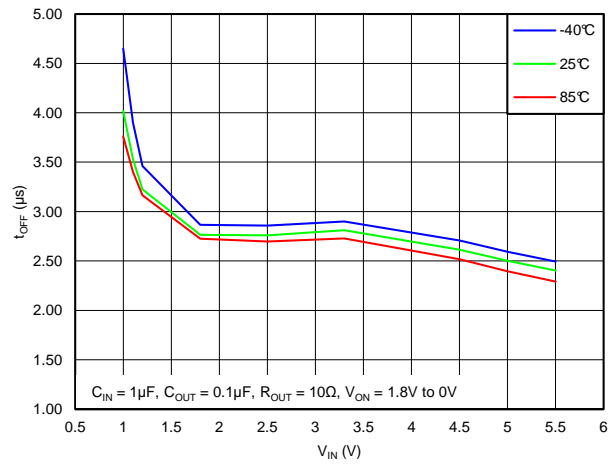

Figure 13. Turn-Off Time vs VIN

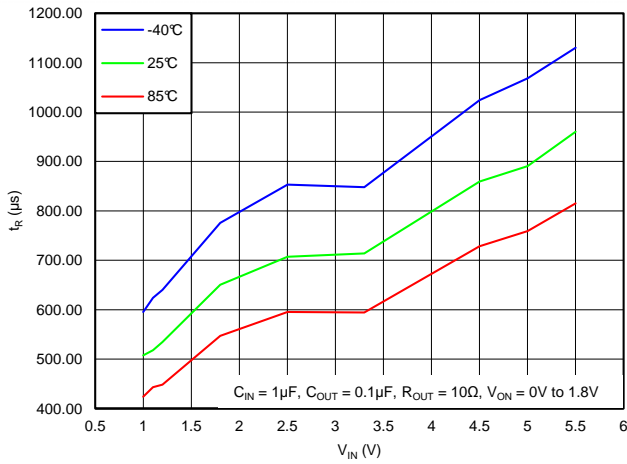

Figure 14. VOUT Rise Time vs VIN

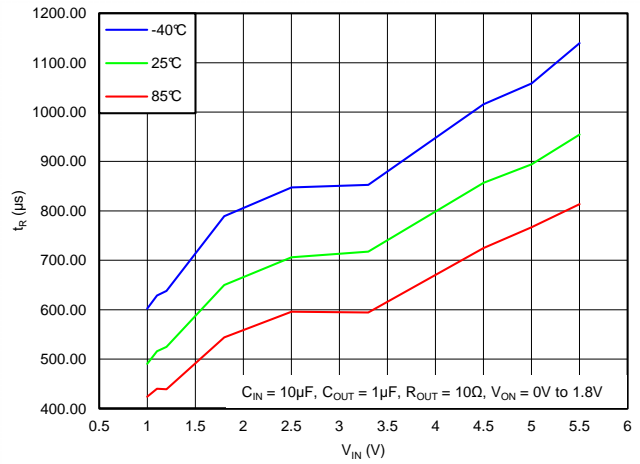

Figure 15. VOUT Rise Time vs VIN

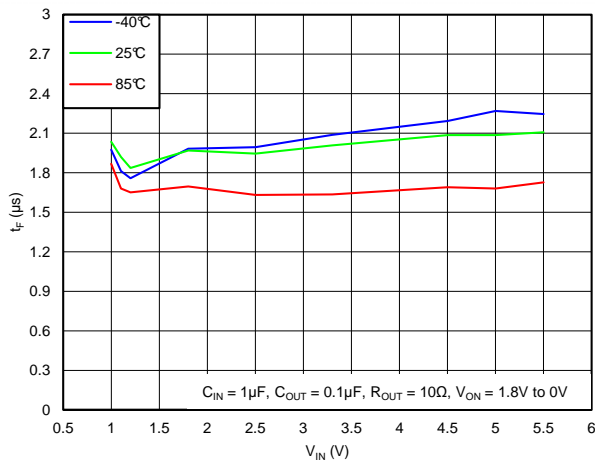

Figure 16. VOUT Fall Time vs VIN

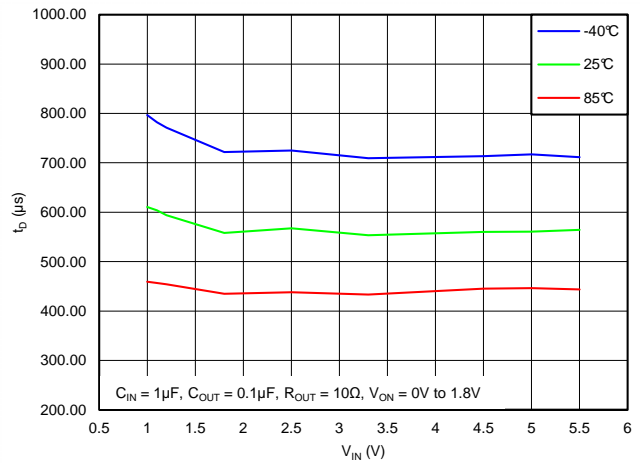

Figure 17. Delay Time vs VIN

### 8.9 Typical AC Scope Captures at $T_A = 25^\circ\text{C}$

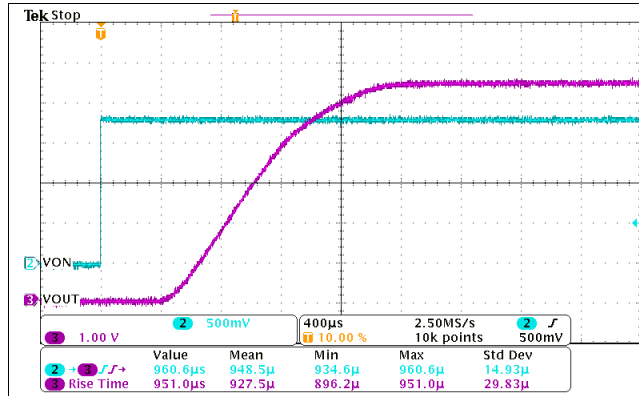

Figure 18. Turn-On Response Time ( $V_{IN} = 5.5\text{ V}$ ,  $C_{IN} = 1\ \mu\text{F}$ ,  $C_{OUT} = 0.1\ \mu\text{F}$ ,  $R_{OUT} = 10\ \Omega$ )

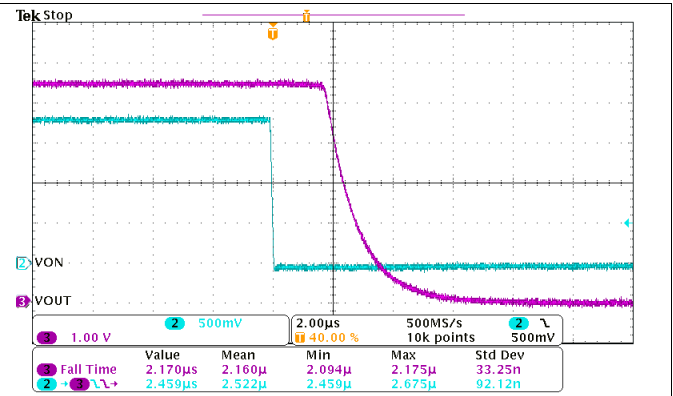

Figure 19. Turn-Off Response Time ( $V_{IN} = 5.5\text{ V}$ ,  $C_{IN} = 1\ \mu\text{F}$ ,  $C_{OUT} = 0.1\ \mu\text{F}$ ,  $R_{OUT} = 10\ \Omega$ )

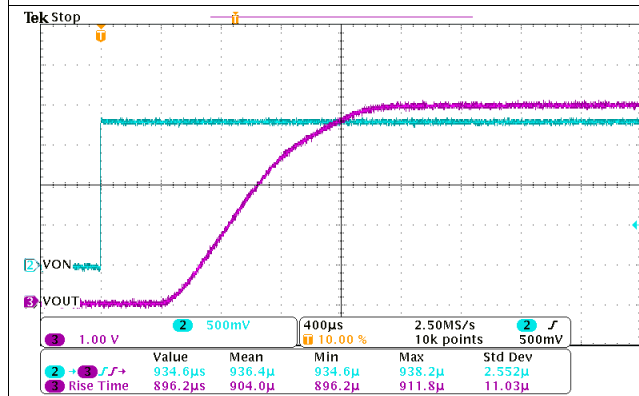

Figure 20. Turn-On Response Time ( $V_{IN} = 5\text{ V}$ ,  $C_{IN} = 1\ \mu\text{F}$ ,  $C_{OUT} = 0.1\ \mu\text{F}$ ,  $R_{OUT} = 10\ \Omega$ )

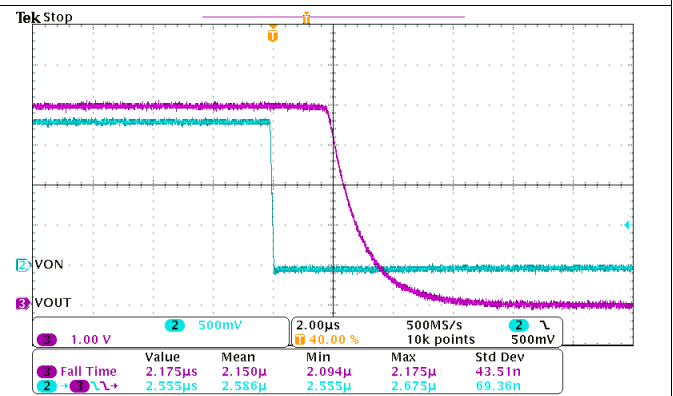

Figure 21. Turn-Off Response Time ( $V_{IN} = 5\text{ V}$ ,  $C_{IN} = 1\ \mu\text{F}$ ,  $C_{OUT} = 0.1\ \mu\text{F}$ ,  $R_{OUT} = 10\ \Omega$ )

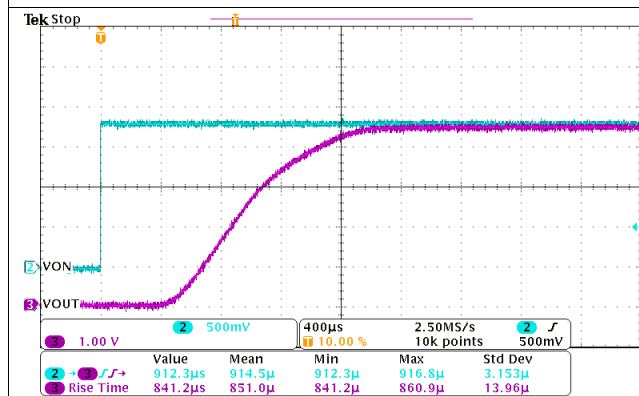

Figure 22. Turn-On Response Time ( $V_{IN} = 4.5\text{ V}$ ,  $C_{IN} = 1\ \mu\text{F}$ ,  $C_{OUT} = 0.1\ \mu\text{F}$ ,  $R_{OUT} = 10\ \Omega$ )

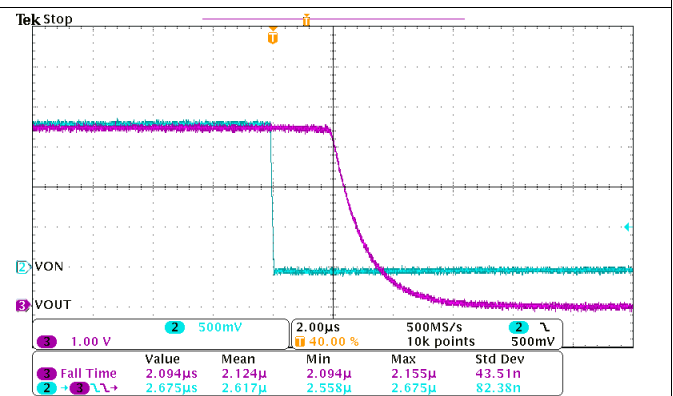

Figure 23. Turn-Off Response Time ( $V_{IN} = 4.5\text{ V}$ ,  $C_{IN} = 1\ \mu\text{F}$ ,  $C_{OUT} = 0.1\ \mu\text{F}$ ,  $R_{OUT} = 10\ \Omega$ )

Typical AC Scope Captures at  $T_A = 25^\circ\text{C}$  (continued)

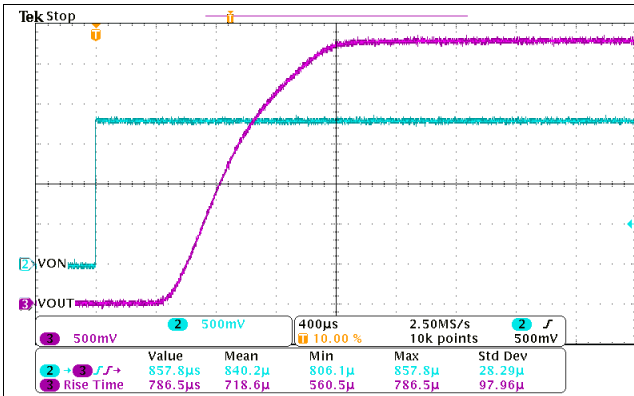

Figure 24. Turn-On Response Time ( $V_{IN} = 3.3\text{ V}$ ,  $C_{IN} = 1\ \mu\text{F}$ ,  $C_{OUT} = 0.1\ \mu\text{F}$ ,  $R_{OUT} = 10\ \Omega$ )

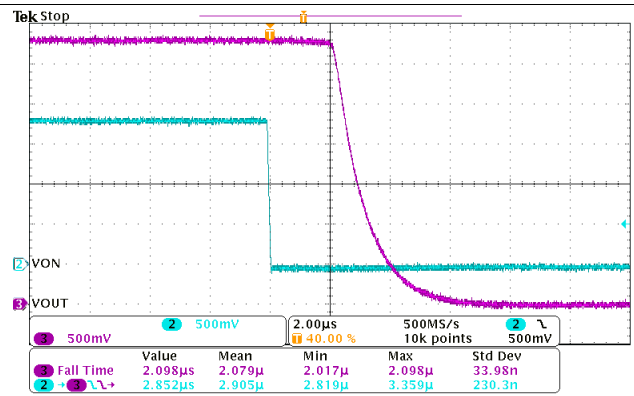

Figure 25. Turn-Off Response Time ( $V_{IN} = 3.3\text{ V}$ ,  $C_{IN} = 1\ \mu\text{F}$ ,  $C_{OUT} = 0.1\ \mu\text{F}$ ,  $R_{OUT} = 10\ \Omega$ )

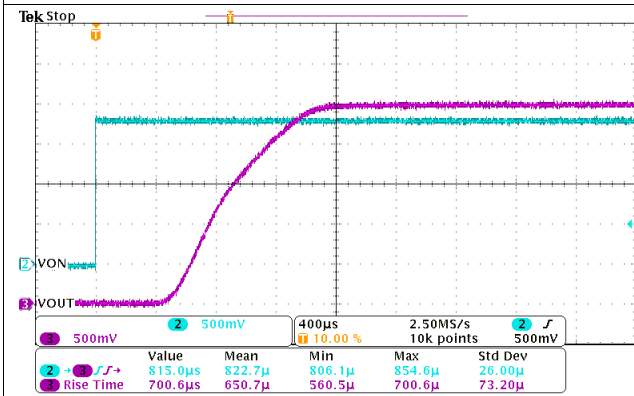

Figure 26. Turn-On Response Time ( $V_{IN} = 2.5\text{ V}$ ,  $C_{IN} = 1\ \mu\text{F}$ ,  $C_{OUT} = 0.1\ \mu\text{F}$ ,  $R_{OUT} = 10\ \Omega$ )

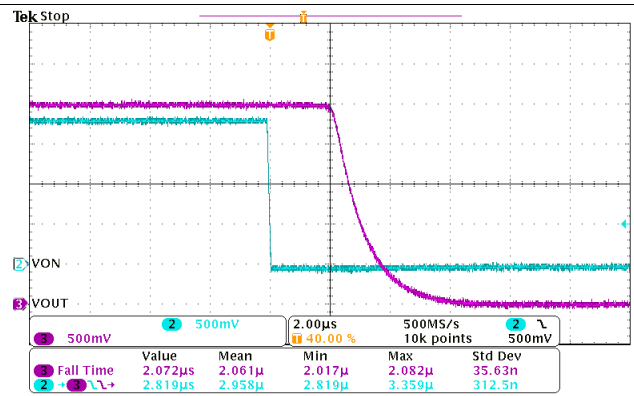

Figure 27. Turn-Off Response Time ( $V_{IN} = 2.5\text{ V}$ ,  $C_{IN} = 1\ \mu\text{F}$ ,  $C_{OUT} = 0.1\ \mu\text{F}$ ,  $R_{OUT} = 10\ \Omega$ )

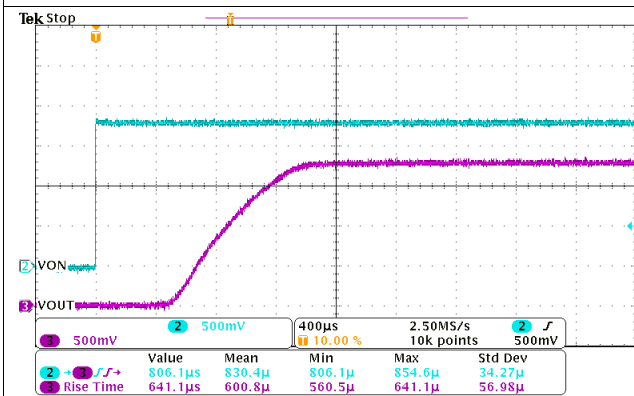

Figure 28. Turn-On Response Time ( $V_{IN} = 1.8\text{ V}$ ,  $C_{IN} = 1\ \mu\text{F}$ ,  $C_{OUT} = 0.1\ \mu\text{F}$ ,  $R_{OUT} = 10\ \Omega$ )

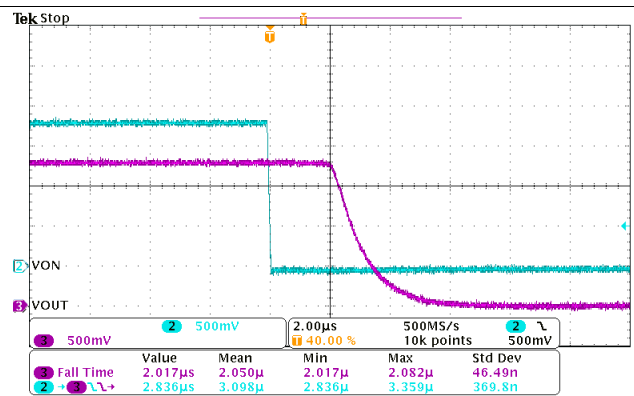

Figure 29. Turn-Off Response Time ( $V_{IN} = 1.8\text{ V}$ ,  $C_{IN} = 1\ \mu\text{F}$ ,  $C_{OUT} = 0.1\ \mu\text{F}$ ,  $R_{OUT} = 10\ \Omega$ )

Typical AC Scope Captures at  $T_A = 25^\circ\text{C}$  (continued)

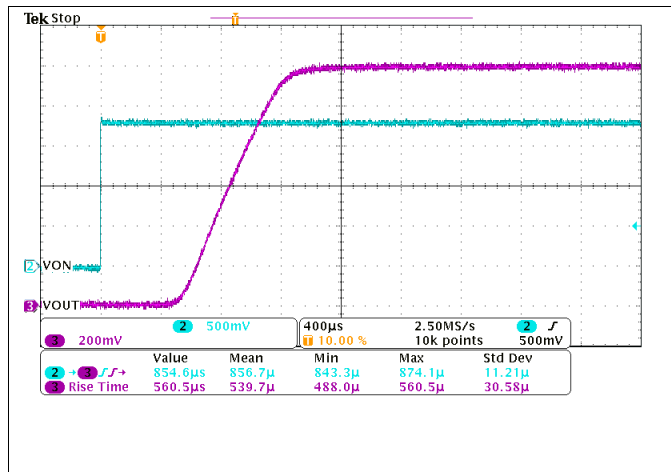

Figure 30. Turn-On Response Time ( $V_{IN} = 1.2\text{ V}$ ,  $C_{IN} = 1\ \mu\text{F}$ ,  $C_{OUT} = 0.1\ \mu\text{F}$ ,  $R_{OUT} = 10\ \Omega$ )

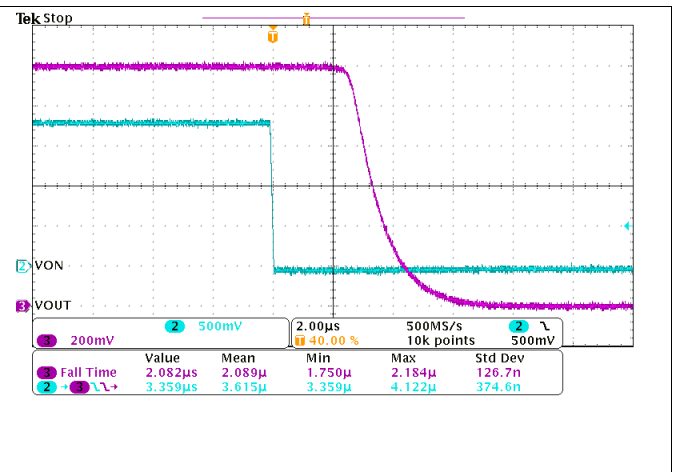

Figure 31. Turn-Off Response Time ( $V_{IN} = 1.2\text{ V}$ ,  $C_{IN} = 1\ \mu\text{F}$ ,  $C_{OUT} = 0.1\ \mu\text{F}$ ,  $R_{OUT} = 10\ \Omega$ )

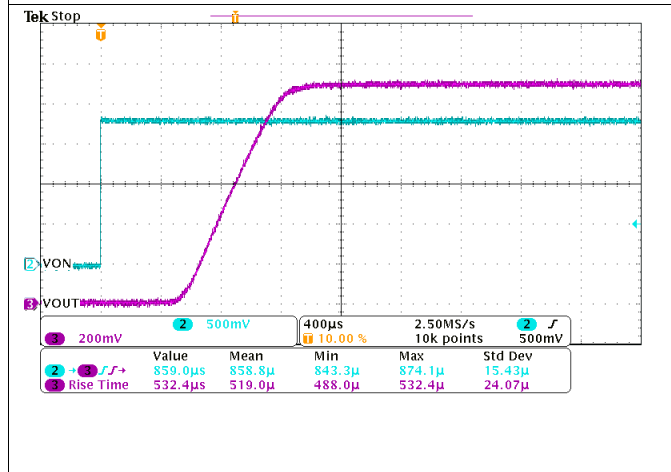

Figure 32. Turn-On Response Time ( $V_{IN} = 1.1\text{ V}$ ,  $C_{IN} = 1\ \mu\text{F}$ ,  $C_{OUT} = 0.1\ \mu\text{F}$ ,  $R_{OUT} = 10\ \Omega$ )

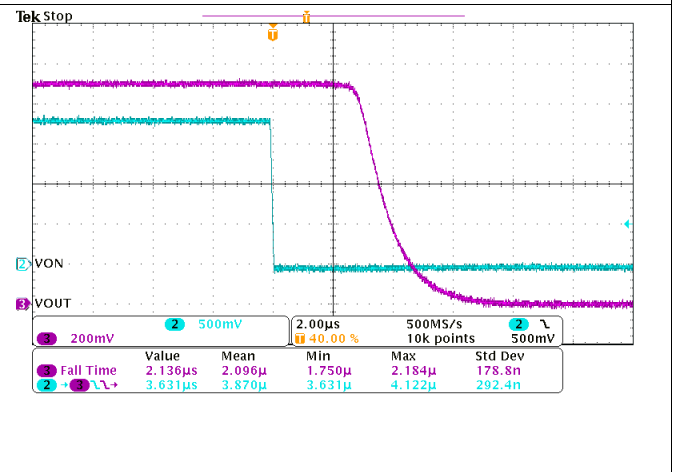

Figure 33. Turn-Off Response Time ( $V_{IN} = 1.1\text{ V}$ ,  $C_{IN} = 1\ \mu\text{F}$ ,  $C_{OUT} = 0.1\ \mu\text{F}$ ,  $R_{OUT} = 10\ \Omega$ )

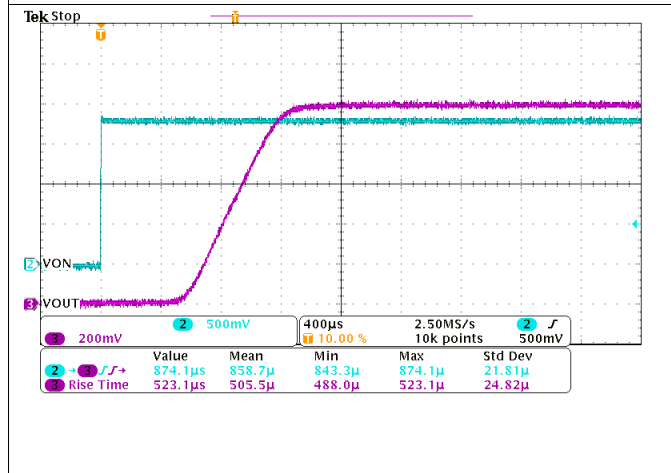

Figure 34. Turn-On Response Time ( $V_{IN} = 1\text{ V}$ ,  $C_{IN} = 1\ \mu\text{F}$ ,  $C_{OUT} = 0.1\ \mu\text{F}$ ,  $R_{OUT} = 10\ \Omega$ )

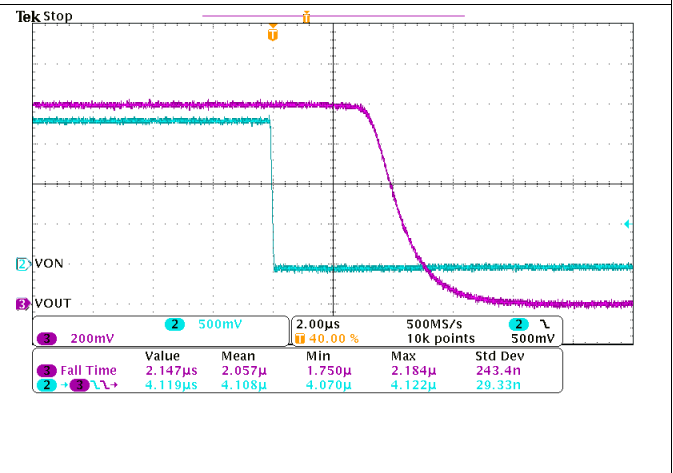

Figure 35. Turn-Off Response Time ( $V_{IN} = 1\text{ V}$ ,  $C_{IN} = 1\ \mu\text{F}$ ,  $C_{OUT} = 0.1\ \mu\text{F}$ ,  $R_{OUT} = 10\ \Omega$ )

## 9 Parametric Measurement Information

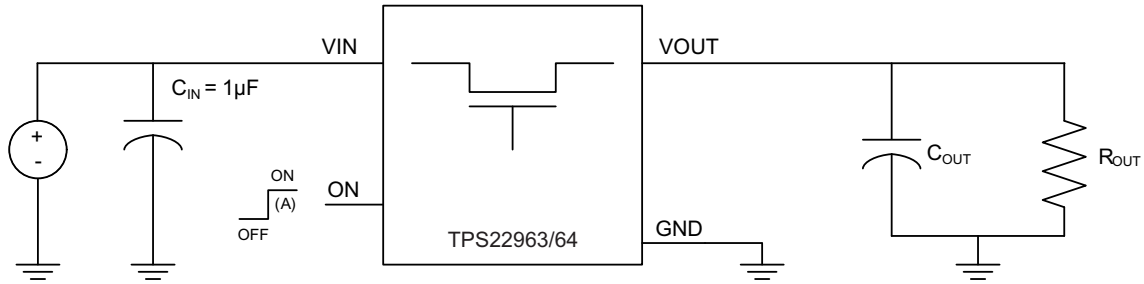
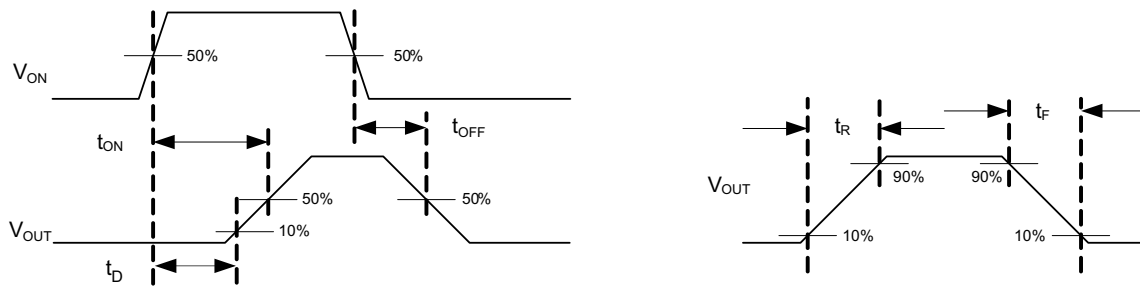

Figure 36. Test Circuit



A. Rise and fall times of the control signal are 100 ns.

Figure 37. Timing Waveforms

## 10 Detailed Description

### 10.1 Overview

The TPS22963/64 is a single channel, 3-A load switch in a small, space saving CSP-6 package. These devices implement an N-channel MOSFET to provide an ultra-low On-resistance for a low voltage drop across the device. A controlled rise time is used in applications to limit the inrush current.

### 10.2 Functional Block Diagram

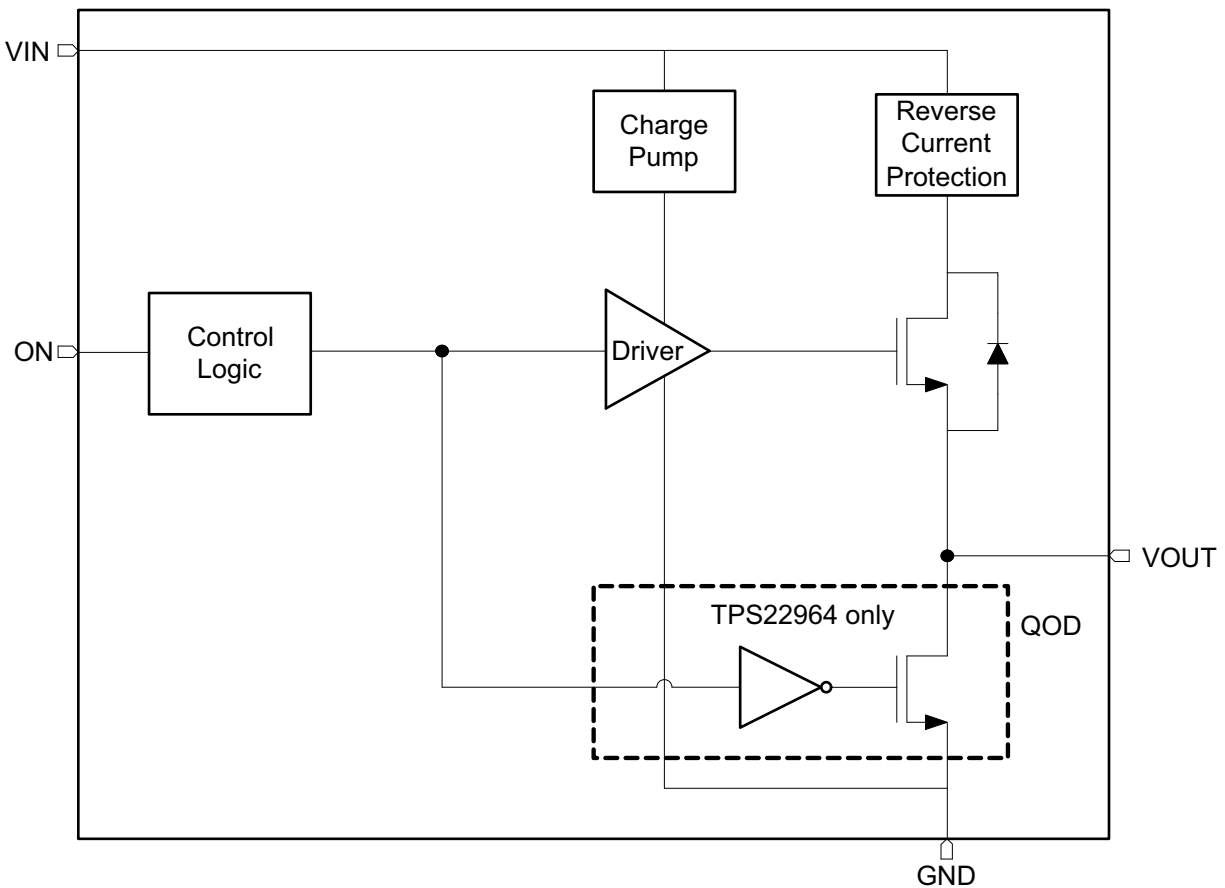

## 10.3 Feature Description

### 10.3.1 On/Off Control

The ON pin controls the state of the switch. It is an active “High” pin and has a low threshold making it capable of interfacing with low voltage GPIO control signals. It can be used with any microcontroller with 1.2 V, 1.8 V, 2.5 V, 3.3 V or 5.5 V GPIOs. Applying  $V_{IH}$  on the ON pin will put the switch in the ON-state and  $V_{IL}$  will put the switch in the OFF-state.

### 10.3.2 Quick Output Discharge

The TPS22964 includes the Quick Output Discharge (QOD) feature. When the switch is disabled, a discharge resistance with a typical value of 273Ω is connected between the output and ground. This resistance pulls down the output and prevents it from floating when the device is disabled.

## 10.4 Device Functional Modes

**Table 1. Function Table**

ON	VIN to VOUT	OUTPUT DISCHARGE <sup>(1) (2)</sup>
L	OFF	ACTIVE
H	ON	DISABLED

- (1) This feature discharges the output of the switch to ground through a 273 Ω resistor, preventing the output from floating.
- (2) This feature is in the TPS22964 device only (not in the TPS22963).

## 11 Application and Implementation

### NOTE

Information in the following applications sections is not part of the TI component specification, and TI does not warrant its accuracy or completeness. TI's customers are responsible for determining suitability of components for their purposes. Customers should validate and test their design implementation to confirm system functionality.

### 11.1 Application Information

#### 11.1.1 Input Capacitor

It is recommended to place a capacitor ( $C_{IN}$ ) between VIN and GND pins of TPS22963/64. This capacitor helps to limit the voltage drop on the input voltage supply when the switch turns ON into a discharged load capacitor. A 1-μF ceramic capacitor that is placed close to the IC pins is usually sufficient. Higher values of  $C_{IN}$  can be used to further reduce the voltage drop in high current applications.

#### 11.1.2 Output Capacitor

It is recommended to place a capacitor ( $C_{OUT}$ ) between VOUT and GND pins of TPS22963/64. This capacitor acts as a low pass filter along with the switch ON-resistance to remove any voltage glitches coming from the input voltage source. It is generally recommended to have  $C_{IN}$  greater than  $C_{OUT}$  so that once the switch is turned ON,  $C_{OUT}$  can charge up to  $V_{IN}$  without  $V_{IN}$  dropping significantly. A 0.1-μF ceramic capacitor that is placed close to the IC pins is usually sufficient.

## Application Information (continued)

### 11.1.3 Standby Power Reduction

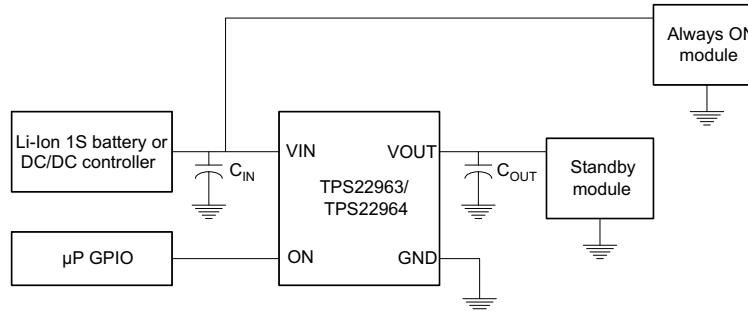

**Figure 38. Standby Power Reduction**

Any end equipment that is being powered from the battery has a need to reduce current consumption in order to keep the battery charged for a longer time. TPS22963/64 helps to accomplish this by turning off the supply to the modules that are in standby state and hence significantly reduces the leakage current overhead of the standby modules.

### 11.1.4 Reverse Current Protection

The reverse current protection feature prevents the current to flow from VOUT to VIN when TPS22963/64 is disabled. This feature is particularly useful when the output of TPS22963/64 needs to be driven by another voltage source after TPS22963/64 is disabled (for example in a power multiplexer application). In order for this feature to work, TPS22963/64 has to be disabled and either of the following conditions shall be met:  $V_{IN} > 1\text{ V}$  or  $V_{OUT} > 1\text{ V}$ .

Figure 39 demonstrates the ideal behavior of reverse current protection circuit in TPS22963/64. After the device is disabled via the ON pin and VOUT is forced to an external voltage  $V_{FORCE}$ , a very small amount of current given by  $I_{RC,VIN}$  will flow from VOUT to VIN. This will prevent any extra current loading on the voltage source supplying the  $V_{FORCE}$  voltage.

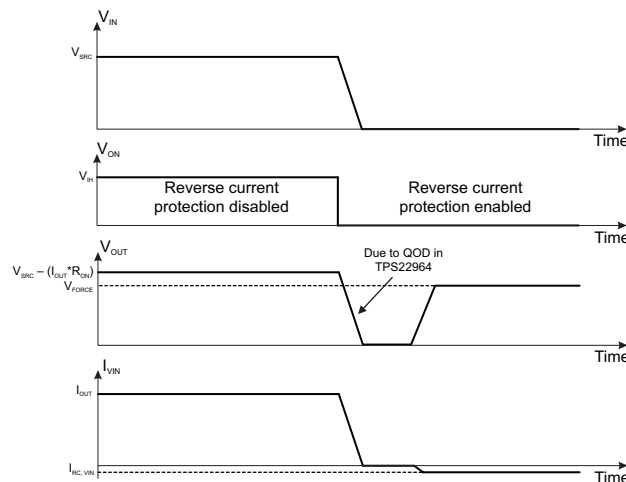

$I_{VIN}$  = Current through VIN pin.

$V_{SRC}$  = Input voltage applied to the device.

$V_{FORCE}$  = External voltage source forced at VOUT pin of the device.

$I_{OUT}$  = Output load current.

**Figure 39. Reverse Current Protection**

## Application Information (continued)

### 11.1.5 Power Supply Sequencing Without a GPIO Input

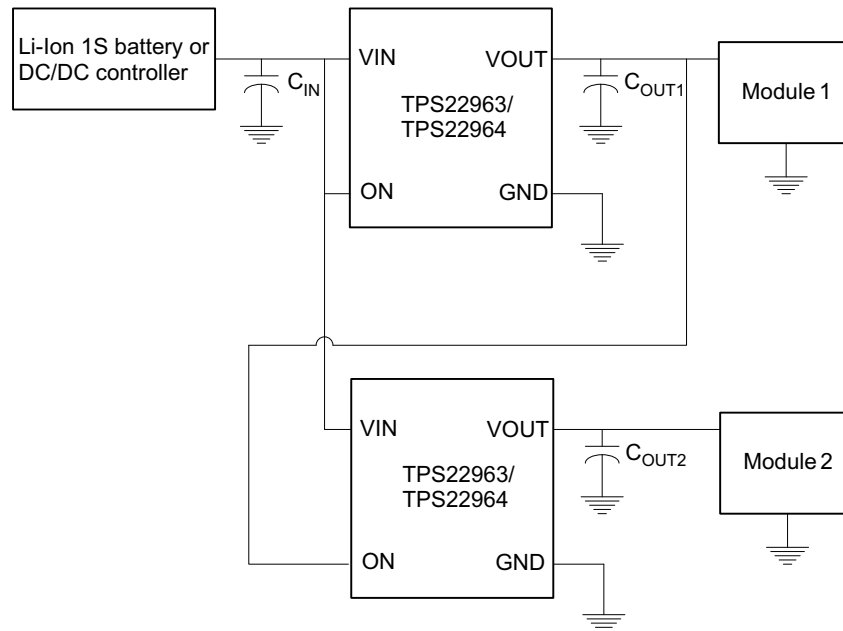

Figure 40. Power Supply Sequencing Without a GPIO Input

In many end equipments, there is a need to power up various modules in a pre-determined manner. TPS22963/64 can solve the problem of power sequencing without adding any complexity to the overall system. Figure 40 shows the configuration required for powering up two modules in a fixed sequence. The output of the first load switch is tied to the enable of the second load switch, so when Module 1 is powered the second load switch is enabled and Module 2 is powered.

## 11.2 Typical Application

TPS22963/64 is an ultra-low ON-resistance, 3-A integrated load switch that is capable of interfacing directly with 1S battery in portable consumer devices such as smartphones, tablets etc. Its wide input voltage range (1 V to 5.5 V) makes it suitable to be used for lower voltage rails as well inside different end equipments to accomplish power sequencing, inrush current control and reducing leakage current in sub-systems that are in standby mode. Figure 41 shows the typical application circuit of TPS22963/64.

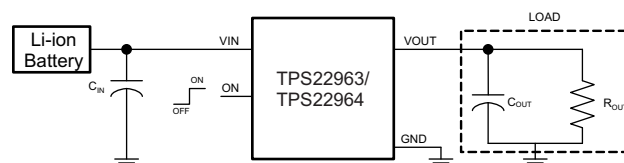

Figure 41. Typical Application Circuit

### 11.2.1 Design Requirements

DESIGN PARAMETER	EXAMPLE VALUE
$V_{IN}$	3.3 V
$C_L$	4.7 $\mu$ F
Maximum Acceptable Inrush Current	30 mA

## 11.2.2 Detailed Design Procedure

### 11.2.2.1 Managing Inrush Current

When the switch is enabled, the output capacitors must be charged up from 0 V to the set value (3.3 V in this example). This charge arrives in the form of inrush current. Inrush current can be calculated using the following equation:

$$I_{\text{INRUSH}} = C_L \times \frac{dV_{\text{OUT}}}{dt}$$

where

- C = output capacitance
- dV = output voltage
- dt = rise time

(1)

The TPS22963/64 offers a controlled rise time for minimizing inrush current. This device can be selected based upon the minimum acceptable rise time which can be calculated using the design requirements and the inrush current equation. An output capacitance of 4.7 μF will be used since the amount of inrush current increases with output capacitance:

$$30 \text{ mA} = 4.7 \text{ } \mu\text{F} \times 3.3 \text{ V} / dt \tag{2}$$

$$dt = 517 \text{ } \mu\text{s} \tag{3}$$

To ensure an inrush current of less than 30 mA, a device with a rise time greater than 517 μs must be used. The TPS22963/64 has a typical rise time of 715 μs at 3.3 V which meets the above design requirements.

### 11.2.3 Application Curves

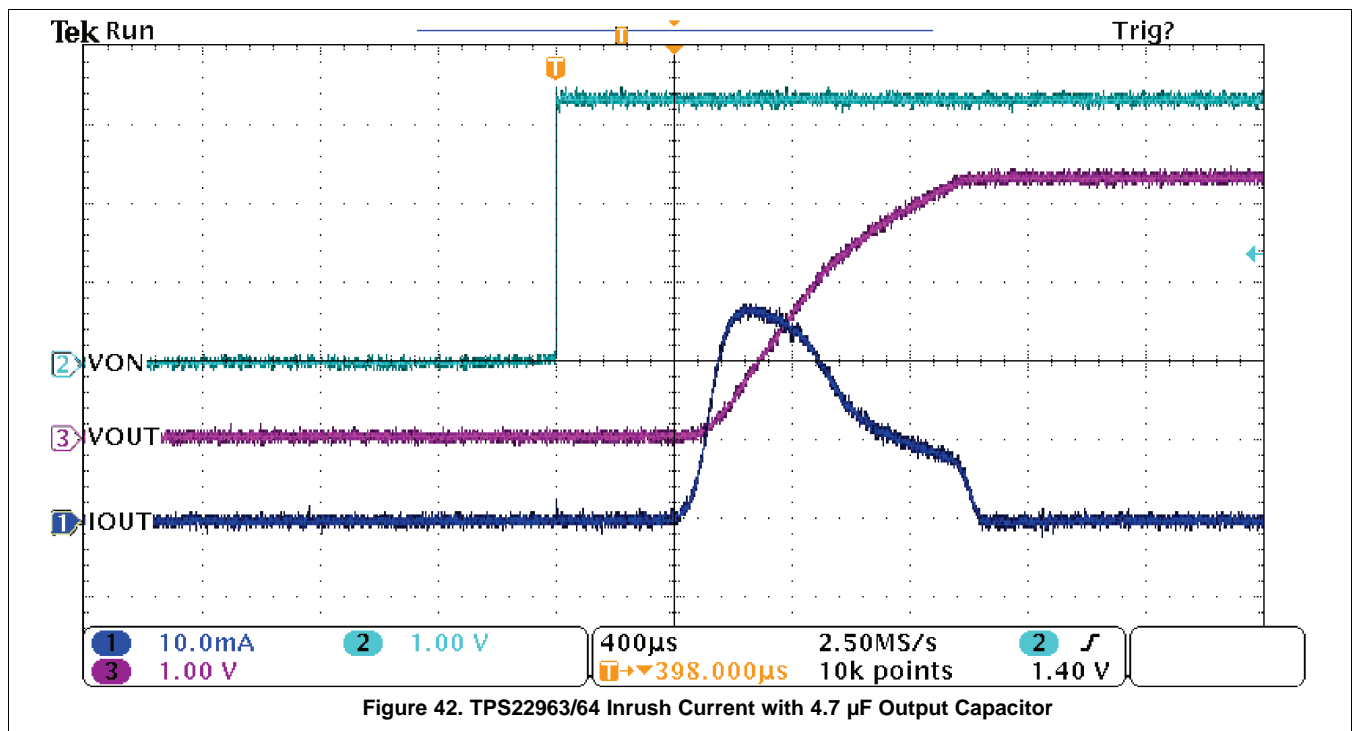

Figure 42. TPS22963/64 Inrush Current with 4.7 μF Output Capacitor

## 12 Power Supply Recommendations

The device is designed to operate with a VIN range of 1 V to 5.5 V. This supply must be well regulated and placed as close to the device terminal as possible with the recommended 1 µF bypass capacitor. If the supply is located more than a few inches from the device terminals, additional bulk capacitance may be required in addition to the ceramic bypass capacitors. If additional bulk capacitance is required, an electrolytic, tantalum, or ceramic capacitor of 10 µF may be sufficient.

## 13 Layout

### 13.1 Layout Guidelines

For best performance, all traces should be as short as possible. To be most effective, the input and output capacitors should be placed close to the device to minimize the effects that parasitic trace inductances may have on normal operation. Using wide traces for VIN, VOUT and GND will help minimize the parasitic electrical effects.

For higher reliability, the maximum IC junction temperature,  $T_{J(max)}$ , should be restricted to 125°C under normal operating conditions. Junction temperature is directly proportional to power dissipation in the device and the two are related by Equation 4.

$$T_J = T_A + \Theta_{JA} \times P_D$$

where

- $T_J$  = Junction temperature of the device
- $T_A$  = Ambient temperature
- $P_D$  = Power dissipation inside the device
- $\Theta_{JA}$  = Junction to ambient thermal resistance. See Thermal Information section of the datasheet. This parameter is highly dependent on board layout.

(4)

### 13.2 Layout Example

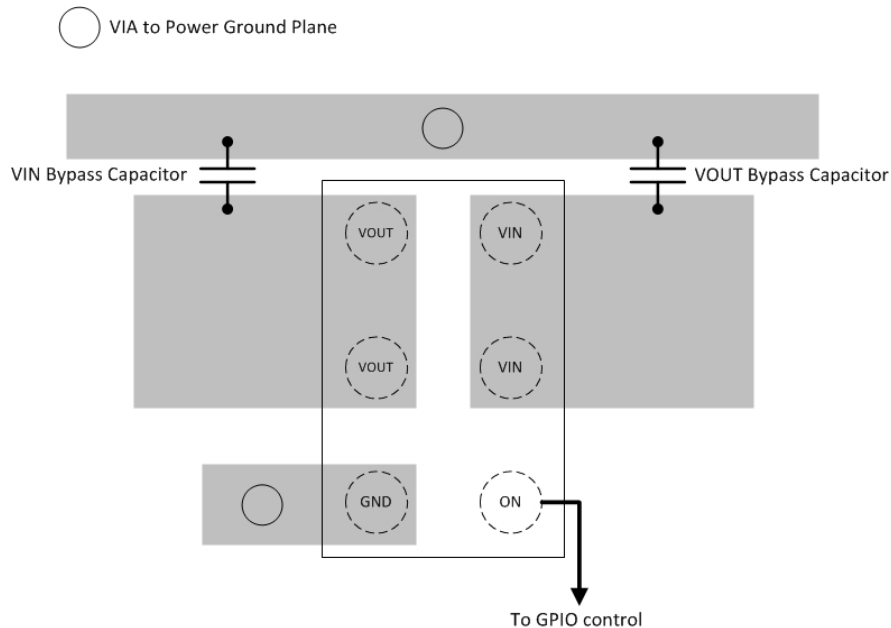

Figure 43. Layout Example

## 14 Device and Documentation Support

### 14.1 Related Links

The table below lists quick access links. Categories include technical documents, support and community resources, tools and software, and quick access to sample or buy.

**Table 2. Related Links**

PARTS	PRODUCT FOLDER	SAMPLE & BUY	TECHNICAL DOCUMENTS	TOOLS & SOFTWARE	SUPPORT & COMMUNITY
TPS22963C	<a href="#">Click here</a>	<a href="#">Click here</a>	<a href="#">Click here</a>	<a href="#">Click here</a>	<a href="#">Click here</a>
TPS22964C	<a href="#">Click here</a>	<a href="#">Click here</a>	<a href="#">Click here</a>	<a href="#">Click here</a>	<a href="#">Click here</a>

### 14.2 Trademarks

Ultrabook is a trademark of Intel Corporation in the U.S. and/or other countries. All other trademarks are the property of their respective owners.

### 14.3 Electrostatic Discharge Caution



These devices have limited built-in ESD protection. The leads should be shorted together or the device placed in conductive foam during storage or handling to prevent electrostatic damage to the MOS gates.

### 14.4 Glossary

[SLYZ022](#) — *TI Glossary*.

This glossary lists and explains terms, acronyms, and definitions.

## 15 Mechanical, Packaging, and Orderable Information

The following pages include mechanical, packaging, and orderable information. This information is the most current data available for the designated devices. This data is subject to change without notice and revision of this document. For browser-based versions of this data sheet, refer to the left-hand navigation.

**PACKAGING INFORMATION**

Orderable Device	Status (1)	Package Type	Package Drawing	Pins	Package Qty	Eco Plan (2)	Lead finish/ Ball material (6)	MSL Peak Temp (3)	Op Temp (°C)	Device Marking (4/5)	Samples
TPS22963CYZPR	ACTIVE	DSBGA	YZP	6	3000	RoHS & Green	SNAGCU	Level-1-260C-UNLIM	-40 to 85	BD	<a href="#">Samples</a>
TPS22963CYZPT	ACTIVE	DSBGA	YZP	6	250	RoHS & Green	SNAGCU	Level-1-260C-UNLIM	-40 to 85	BD	<a href="#">Samples</a>
TPS22964C2YZPR	ACTIVE	DSBGA	YZP	6	6000	RoHS & Green	SNAGCU	Level-1-260C-UNLIM	-40 to 85	DK	<a href="#">Samples</a>
TPS22964CYZPR	ACTIVE	DSBGA	YZP	6	3000	RoHS & Green	SNAGCU	Level-1-260C-UNLIM	-40 to 85	DK	<a href="#">Samples</a>
TPS22964CYZPT	ACTIVE	DSBGA	YZP	6	250	RoHS & Green	SNAGCU	Level-1-260C-UNLIM	-40 to 85	DK	<a href="#">Samples</a>

(1) The marketing status values are defined as follows:

**ACTIVE:** Product device recommended for new designs.

**LIFEBUY:** TI has announced that the device will be discontinued, and a lifetime-buy period is in effect.

**NRND:** Not recommended for new designs. Device is in production to support existing customers, but TI does not recommend using this part in a new design.

**PREVIEW:** Device has been announced but is not in production. Samples may or may not be available.

**OBSELETE:** TI has discontinued the production of the device.

(2) **RoHS:** TI defines "RoHS" to mean semiconductor products that are compliant with the current EU RoHS requirements for all 10 RoHS substances, including the requirement that RoHS substance do not exceed 0.1% by weight in homogeneous materials. Where designed to be soldered at high temperatures, "RoHS" products are suitable for use in specified lead-free processes. TI may reference these types of products as "Pb-Free".

**RoHS Exempt:** TI defines "RoHS Exempt" to mean products that contain lead but are compliant with EU RoHS pursuant to a specific EU RoHS exemption.

**Green:** TI defines "Green" to mean the content of Chlorine (Cl) and Bromine (Br) based flame retardants meet JS709B low halogen requirements of <=1000ppm threshold. Antimony trioxide based flame retardants must also meet the <=1000ppm threshold requirement.

(3) MSL, Peak Temp. - The Moisture Sensitivity Level rating according to the JEDEC industry standard classifications, and peak solder temperature.

(4) There may be additional marking, which relates to the logo, the lot trace code information, or the environmental category on the device.

(5) Multiple Device Markings will be inside parentheses. Only one Device Marking contained in parentheses and separated by a "~" will appear on a device. If a line is indented then it is a continuation of the previous line and the two combined represent the entire Device Marking for that device.

(6) Lead finish/Ball material - Orderable Devices may have multiple material finish options. Finish options are separated by a vertical ruled line. Lead finish/Ball material values may wrap to two lines if the finish value exceeds the maximum column width.

**Important Information and Disclaimer:** The information provided on this page represents TI's knowledge and belief as of the date that it is provided. TI bases its knowledge and belief on information provided by third parties, and makes no representation or warranty as to the accuracy of such information. Efforts are underway to better integrate information from third parties. TI has taken and continues to take reasonable steps to provide representative and accurate information but may not have conducted destructive testing or chemical analysis on incoming materials and chemicals. TI and TI suppliers consider certain information to be proprietary, and thus CAS numbers and other limited information may not be available for release.

In no event shall TI's liability arising out of such information exceed the total purchase price of the TI part(s) at issue in this document sold by TI to Customer on an annual basis.

**TAPE AND REEL INFORMATION**

**QUADRANT ASSIGNMENTS FOR PIN 1 ORIENTATION IN TAPE**

\*All dimensions are nominal

Device	Package Type	Package Drawing	Pins	SPQ	Reel Diameter (mm)	Reel Width W1 (mm)	A0 (mm)	B0 (mm)	K0 (mm)	P1 (mm)	W (mm)	Pin1 Quadrant
TPS22963CYZPR	DSBGA	YZP	6	3000	180.0	8.4	1.04	1.54	0.56	4.0	8.0	Q1
TPS22963CYZPT	DSBGA	YZP	6	250	180.0	8.4	1.04	1.54	0.56	4.0	8.0	Q1
TPS22964C2YZPR	DSBGA	YZP	6	6000	180.0	8.4	1.04	1.57	0.6	2.0	8.0	Q1
TPS22964CYZPR	DSBGA	YZP	6	3000	180.0	8.4	1.04	1.54	0.56	4.0	8.0	Q1
TPS22964CYZPR	DSBGA	YZP	6	3000	180.0	8.4	1.04	1.57	0.6	4.0	8.0	Q1
TPS22964CYZPT	DSBGA	YZP	6	250	180.0	8.4	1.04	1.57	0.6	4.0	8.0	Q1
TPS22964CYZPT	DSBGA	YZP	6	250	180.0	8.4	1.04	1.54	0.56	4.0	8.0	Q1

**TAPE AND REEL BOX DIMENSIONS**

\*All dimensions are nominal

Device	Package Type	Package Drawing	Pins	SPQ	Length (mm)	Width (mm)	Height (mm)
TPS22963CZPR	DSBGA	YZP	6	3000	182.0	182.0	20.0
TPS22963CZPT	DSBGA	YZP	6	250	182.0	182.0	20.0
TPS22964C2YZPR	DSBGA	YZP	6	6000	182.0	182.0	20.0
TPS22964CZPR	DSBGA	YZP	6	3000	182.0	182.0	20.0
TPS22964CZPT	DSBGA	YZP	6	250	182.0	182.0	20.0
TPS22964CZPT	DSBGA	YZP	6	250	182.0	182.0	20.0

YZP0006



PACKAGE OUTLINE

DSBGA - 0.5 mm max height

DIE SIZE BALL GRID ARRAY

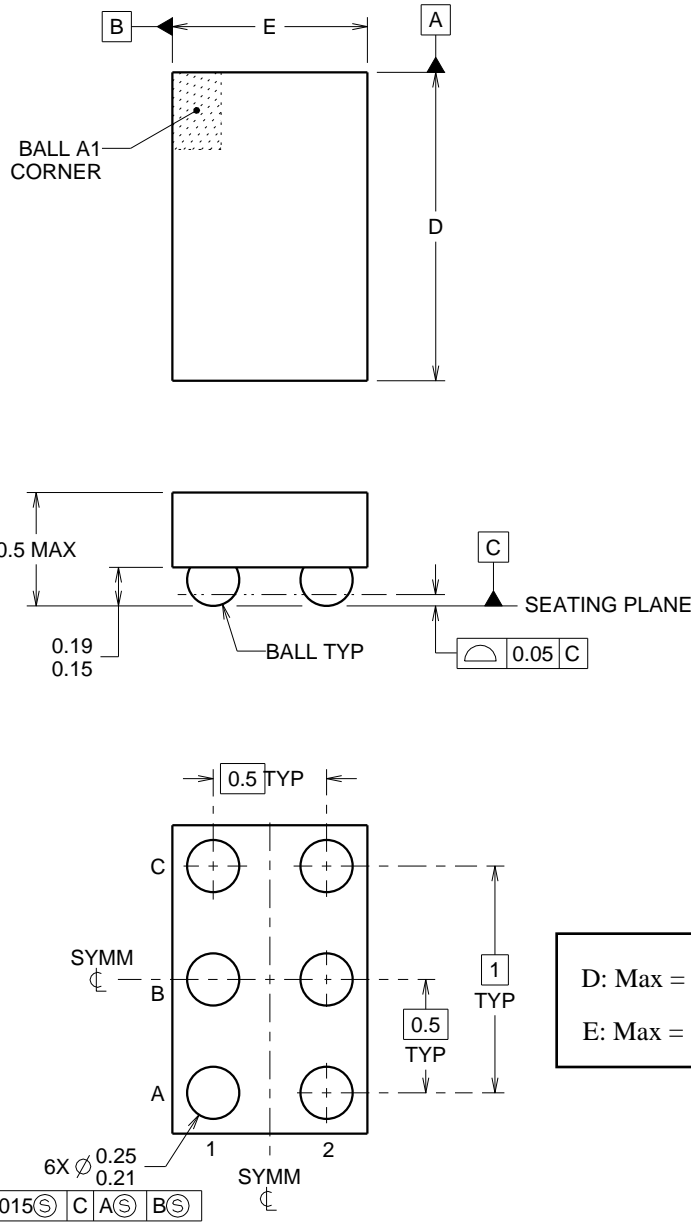

4219524/A 06/2014

NOTES:

NanoFree Is a trademark of Texas Instruments.

1. All linear dimensions are in millimeters. Any dimensions in parenthesis are for reference only. Dimensioning and tolerancing per ASME Y14.5M.
2. This drawing is subject to change without notice.
3. NanoFree™ package configuration.

# EXAMPLE BOARD LAYOUT

YZP0006

DSBGA - 0.5 mm max height

DIE SIZE BALL GRID ARRAY



LAND PATTERN EXAMPLE  
SCALE:40X

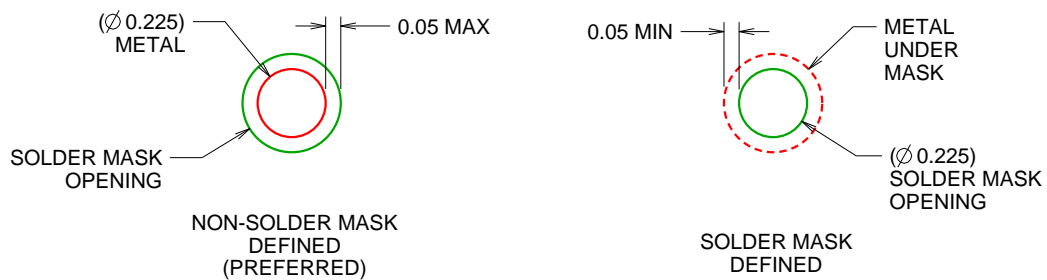

SOLDER MASK DETAILS  
NOT TO SCALE

4219524/A 06/2014

NOTES: (continued)

- Final dimensions may vary due to manufacturing tolerance considerations and also routing constraints. For more information, see Texas Instruments literature number SBVA017 ([www.ti.com/lit/sbva017](http://www.ti.com/lit/sbva017)).

# EXAMPLE STENCIL DESIGN

YZP0006

DSBGA - 0.5 mm max height

DIE SIZE BALL GRID ARRAY

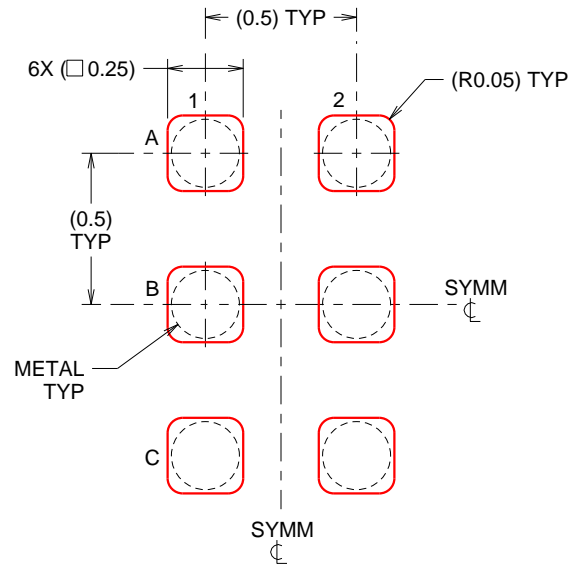

SOLDER PASTE EXAMPLE  
BASED ON 0.1 mm THICK STENCIL  
SCALE:40X

4219524/A 06/2014

NOTES: (continued)

5. Laser cutting apertures with trapezoidal walls and rounded corners may offer better paste release.

## IMPORTANT NOTICE AND DISCLAIMER

TI PROVIDES TECHNICAL AND RELIABILITY DATA (INCLUDING DATA SHEETS), DESIGN RESOURCES (INCLUDING REFERENCE DESIGNS), APPLICATION OR OTHER DESIGN ADVICE, WEB TOOLS, SAFETY INFORMATION, AND OTHER RESOURCES "AS IS" AND WITH ALL FAULTS, AND DISCLAIMS ALL WARRANTIES, EXPRESS AND IMPLIED, INCLUDING WITHOUT LIMITATION ANY IMPLIED WARRANTIES OF MERCHANTABILITY, FITNESS FOR A PARTICULAR PURPOSE OR NON-INFRINGEMENT OF THIRD PARTY INTELLECTUAL PROPERTY RIGHTS.

These resources are intended for skilled developers designing with TI products. You are solely responsible for (1) selecting the appropriate TI products for your application, (2) designing, validating and testing your application, and (3) ensuring your application meets applicable standards, and any other safety, security, regulatory or other requirements.

These resources are subject to change without notice. TI grants you permission to use these resources only for development of an application that uses the TI products described in the resource. Other reproduction and display of these resources is prohibited. No license is granted to any other TI intellectual property right or to any third party intellectual property right. TI disclaims responsibility for, and you will fully indemnify TI and its representatives against, any claims, damages, costs, losses, and liabilities arising out of your use of these resources.

TI's products are provided subject to [TI's Terms of Sale](#) or other applicable terms available either on [ti.com](https://www.ti.com) or provided in conjunction with such TI products. TI's provision of these resources does not expand or otherwise alter TI's applicable warranties or warranty disclaimers for TI products.

TI objects to and rejects any additional or different terms you may have proposed.

Mailing Address: Texas Instruments, Post Office Box 655303, Dallas, Texas 75265  
Copyright © 2023, Texas Instruments Incorporated

## Looking for pricing, stock, or lifecycle information?

Click below to explore more details on WIN SOURCE:

 [View TPS22963CZPR on WIN SOURCE](#)

 [Texas Instruments](#) Information

## Optimize Your Supply Chain with WIN SOURCE Solutions

-  Global Sourcing Solution
-  Obsolete Management
-  Cost Control Management
-  Shortage Management
-  Alternative Solution
-  Excess Inventory Management