



**THE DATASHEET OF
JMK212BJ226KG-T**



To: DIGIKEY

PRODUCT SPECIFICATION

P/N: 212TYPE
Type: Multilayer Ceramic Capacitors
Issue date: 12.Jun.2012

Applicable products to RoHS restriction

Document No.

MLCEE120G2

Specifications
High Value Multilayer Ceramic Capacitor
(High dielectric type)

1. Scope

This specification covers multilayer chip type ceramic capacitor (Pb-Free) for use in electronic appliances and electric communication equipment.

2. Part Numbering System

Part number is indicated as follows:

(Example) : $\frac{J}{\textcircled{1}}$ MK $\frac{212}{\textcircled{2}}$ $\frac{A}{\textcircled{3}}$ $\frac{BJ}{\textcircled{4}}$ Capacitance $\frac{226}{\textcircled{5}}$ $\frac{K}{\textcircled{6}}$ $\frac{-T}{\textcircled{7}}$

① Rated voltage(DC)

Code	Voltage
J	6.3V

② Size (mm)

Code	Size
212	2.0×1.25

③ Control Code: Per Table1

※Space for all standard specs.

④ Temperature Characteristic

Characteristic	Capacitance change rate	Temperature range	Reference temperature
BJ (X5R)	± 15% (EIA)	-55~+85℃	25℃

⑤ Tolerance

Code	Tolerance
K	± 10%
M	± 20%

⑥ Thickness code (Ni based electrodes)

Type	Code	Thickness rank (mm)
212	G	1.25

⑦ Packaging

Code	Packaging
-T	Taping

High Value Multilayer Ceramic Chip Capacitor

3. Test Conditions

Standard test conditions shall be temperature of 5 to 35°C, relative humidity of 45 to 85% and air pressure of 86 to 106kPa. Test shall be conducted at temperature of 25±3°C, relative humidity of 60 to 70% and air pressure of 86 to 106kPa if test result is suspectable.

Unless otherwise specified, all tests shall be conducted under standard test conditions.

4. Construction, Dimensions and Performance

Details of construction, dimensions and performance shall be specified in the following pages.

5. Packaging

Packaging shall be made to avoid damages of capacitors during transportation or storage. And it shall be marked with part number, quantity, lot number and manufacturer's name on its appropriate position.

6. Manufacturing site

TAIYO YUDEN CO., LTD. (JAPAN)

TAIYO YUDEN (SARAWAK) SDN, BHD. (MALAYSIA)

KOREA KYONG NAM TAIYO YUDEN CO., LTD. (KOREA)

TAIYO YUDEN (GUANG DONG) CO., LTD. (CHINA)

TAIYO YUDEN (PHILIPPINES) INC. (PHILIPPINES)

7. Precautions

• Please refer to precautions in our general catalog prior to product usage.

If you need further information, please contact us.

• CAUTION: Contents of this specification cannot be assured with Sn-Zn lead-free solder usage.

8. Storage conditions

• To maintain the solderability of terminal electrodes and to keep the packaging material in good condition, care must be taken to control temperature and humidity in the storage area. Humidity should especially be kept as low as possible.

• Recommended conditions

Ambient temperature: 30°C and below

Humidity: 70% RH and below

The ambient temperature must be kept below 40°C. Even under ideal storage conditions, capacitor electrode solderability decreases with time. Therefore ceramic chip capacitors should be used within 6 months from the time of delivery. If exceeding the above period, please check solderability before using the capacitors.

• The packaging material should be kept where no chlorine or sulfur exists in the air.

High Value Multilayer Ceramic Chip Capacitor

9. RoHS compliance

- This product conform to RoHS.
- "RoHS compliance" means that the product does not contain lead, cadmium, mercury, hexavalent chromium, PBB or PBDE referring to EU Directive 2002/95/EC, except other non-restricted substances or impurities which cannot be technically removed at refining process.

10. Others

Resin-coating:

- Coating/molding capacitors with resin may have negative effects on the capacitor functions.
- When capacitors are coated/molded with resin, please check effects on the capacitors by analyzing them in actual applications prior to use.

No.	Item	Specified Value	Remarks												
1	Operating Temperature Range	Capable of continuous operation under these conditions.	-55~+85°C												
2	Shape and Dimensions	Per Fig.1													
3	Heat Treatment		Initial value shall be measured after test sample is heat-treated at 150 +0/-10°C for an hour and kept at room temperature for 24 ± 2hours.												
4	Voltage Treatment		Initial value shall be measured after test sample is voltage-treated for an hour at temperature and voltage which are specified as test conditions, and kept at room temperature for 24 ± 2hours.												
5	Dielectric Withstanding Voltage (between terminals)	No abnormality	Conforming to EIA RS-198-D (1991). 250% of DC rated voltage shall be applied for 1 to 5 seconds. Charging and discharging current shall be 50mA or less.												
6	Insulation Resistance	Per Table2	Conforming to EIA RS-198-D (1991). Voltage for the measurement shall be rated voltage and voltage applying time shall be 1 minute ± 5 seconds. Charging and discharging current shall be 50mA or less.												
7	Capacitance	Per Table1	Conforming to EIA RS-198-D (1991). Heat treatment specified in No.3 of the specification shall be conducted prior to measurement. Measuring frequency and voltage shall conform to the table shown below. <table border="1" data-bbox="858 1167 1412 1341"> <thead> <tr> <th>No.</th> <th>Measuring Frequency</th> <th>Measuring Voltage</th> </tr> </thead> <tbody> <tr> <td>1</td> <td>120Hz ± 10Hz</td> <td>0.5 ± 0.1Vrms</td> </tr> <tr> <td>2</td> <td>1kHz ± 10%</td> <td>1.0 ± 0.2Vrms</td> </tr> <tr> <td>3</td> <td>1kHz ± 10%</td> <td>0.5 ± 0.1Vrms</td> </tr> </tbody> </table>	No.	Measuring Frequency	Measuring Voltage	1	120Hz ± 10Hz	0.5 ± 0.1Vrms	2	1kHz ± 10%	1.0 ± 0.2Vrms	3	1kHz ± 10%	0.5 ± 0.1Vrms
No.	Measuring Frequency	Measuring Voltage													
1	120Hz ± 10Hz	0.5 ± 0.1Vrms													
2	1kHz ± 10%	1.0 ± 0.2Vrms													
3	1kHz ± 10%	0.5 ± 0.1Vrms													
8	Dissipation Factor (DF)	Per Table1	Conforming to EIA RS-198-D (1991). Heat treatment specified in No.3 of the specification shall be conducted prior to measurement. Measuring frequency and voltage shall conform to the table shown below. <table border="1" data-bbox="858 1547 1412 1722"> <thead> <tr> <th>No.</th> <th>Measuring Frequency</th> <th>Measuring Voltage</th> </tr> </thead> <tbody> <tr> <td>1</td> <td>120Hz ± 10Hz</td> <td>0.5 ± 0.1Vrms</td> </tr> <tr> <td>2</td> <td>1kHz ± 10%</td> <td>1.0 ± 0.2Vrms</td> </tr> <tr> <td>3</td> <td>1kHz ± 10%</td> <td>0.5 ± 0.1Vrms</td> </tr> </tbody> </table>	No.	Measuring Frequency	Measuring Voltage	1	120Hz ± 10Hz	0.5 ± 0.1Vrms	2	1kHz ± 10%	1.0 ± 0.2Vrms	3	1kHz ± 10%	0.5 ± 0.1Vrms
No.	Measuring Frequency	Measuring Voltage													
1	120Hz ± 10Hz	0.5 ± 0.1Vrms													
2	1kHz ± 10%	1.0 ± 0.2Vrms													
3	1kHz ± 10%	0.5 ± 0.1Vrms													

No.	Item	Specified Value	Remarks
9	Temperature Characteristic	Per P1④Temperature Characteristic	Conforming to EIA RS-198-D (1991). Heat treatment specified in No.3 of the specification shall be conducted prior to measurement. Maximum capacitance deviation in both (+) and (-) sides in range of lowest temperature to highest temperature for capacitor shall be indicated in ratio of variation in reference to capacitance value at reference temperature.
10	Adhesive Force of Terminal Electrodes	Terminal electrodes shall be no exfoliation or a sign of exfoliation.	Test sample shall be soldered to test board shown in Fig.2 and a force of 5N{0.51kgf} shall be applied in arrow direction for 30±5 seconds.
11	Vibration	Initial performance shall be satisfied.	Conforming to EIA RS-198-D (1991). Test sample shall be soldered to board shown in Fig.2. Heat treatment specified in No.3 of the specification shall be conducted prior to test. Test conditions: Frequency range: 10~55Hz Overall amplitude: 1.5mm Sweeping method: 10~55~10Hz for 1 min. Each two hours in X,Y,Z direction: 6 hours in total

No.	Item	Specified Value	Remarks															
12	Resistance to Soldering Heat	Appearance	No abnormality															
		Capacitance Change	Per Table2															
		Dissipation Factor	Per Table2															
		Insulation Resistance	Initial value shall be satisfied.															
		Dielectric Withstanding Voltage (between terminals)	No abnormality															
			<p>Conforming to EIA RS-198-D (1991). Used solder shall be [JIS Z 3282 H60A or H63A]. Test sample shall be completely submerged in molten solder of $270 \pm 5^\circ\text{C}$ for 3 ± 0.5 seconds. Preheating as shown in the table below shall be continuously conducted before submersion and test sample shall be kept at normal temperature after test.</p> <table border="1"> <thead> <tr> <th>Sequence</th> <th>Temperature ($^\circ\text{C}$)</th> <th>Time (min)</th> </tr> </thead> <tbody> <tr> <td>1</td> <td>80~100</td> <td>2~5</td> </tr> <tr> <td>2</td> <td>150~200</td> <td>2~5</td> </tr> </tbody> </table> <p>Heat treatment specified in No.3 of the specification shall be conducted prior to test. Measurement shall be conducted after test sample is kept at room temperature for 24 ± 2 hours.</p>	Sequence	Temperature ($^\circ\text{C}$)	Time (min)	1	80~100	2~5	2	150~200	2~5						
Sequence	Temperature ($^\circ\text{C}$)	Time (min)																
1	80~100	2~5																
2	150~200	2~5																
13	Solderability	More than 95% of terminal electrode shall be covered with fresh solder.	<p>【Eutectic】 Used solder shall be [JIS Z 3282 H60A or H63A]. Test sample shall be completely submerged in molten solder of $230 \pm 5^\circ\text{C}$ for 4 ± 1 seconds.</p>															
			<p>【Pb free】 Used solder shall be [Sn/3.0Ag/0.5Cu]. Test sample shall be completely submerged in molten solder of $245 \pm 3^\circ\text{C}$ for 4 ± 1 seconds.</p>															
14	Thermal Shock	Appearance	No abnormality															
		Capacitance Change	Per Table2															
		Dissipation Factor	Per Table2															
		Insulation Resistance	Initial value shall be satisfied.															
		Dielectric Withstanding Voltage (between terminals)	No abnormality															
			<p>Conforming to EIA RS-198-D (1991). Test sample shall be soldered to board shown in Fig.2. Heat treatment specified in No.3 of the specification shall be conducted prior to test. Test sample shall be kept for specified time at each of temperature in steps 1 to 4 shown below in sequence.</p> <table border="1"> <thead> <tr> <th>Step</th> <th>Temperature ($^\circ\text{C}$)</th> <th>Time (min)</th> </tr> </thead> <tbody> <tr> <td>1</td> <td>Lowest operating temperature</td> <td>30 ± 3</td> </tr> <tr> <td>2</td> <td>Normal temperature</td> <td>2~3</td> </tr> <tr> <td>3</td> <td>Highest operating temperature</td> <td>30 ± 3</td> </tr> <tr> <td>4</td> <td>Normal temperature</td> <td>2~3</td> </tr> </tbody> </table> <p>Temperature cycle shall be repeated five times in this method, and measurement shall be conducted after test sample is kept for 24 ± 2 hours.</p>	Step	Temperature ($^\circ\text{C}$)	Time (min)	1	Lowest operating temperature	30 ± 3	2	Normal temperature	2~3	3	Highest operating temperature	30 ± 3	4	Normal temperature	2~3
Step	Temperature ($^\circ\text{C}$)	Time (min)																
1	Lowest operating temperature	30 ± 3																
2	Normal temperature	2~3																
3	Highest operating temperature	30 ± 3																
4	Normal temperature	2~3																

No.	Item	Specified Value	Remarks	
15	Humidity (Steady State)	Appearance	No abnormality	Conforming to EIA RS-198-D (1991). Test sample shall be at $40 \pm 2^\circ\text{C}$ with relative humidity of 90 to 95% for 500 +24/-0 hours. Heat treatment specified in No.3 of the specification shall be conducted prior to test. Measurement shall be conducted after test sample is kept for 24 ± 2 hours.
		Capacitance Change	Per Table2	
		Dissipation Factor	Per Table2	
		Insulation Resistance	Per Table2	
16	High Temperature Loading	Appearance	No abnormality	Conforming to EIA RS-198-D (1991). Test sample shall be put in thermostatic oven with maximum temperature and DC voltage shall be continuously applied for 1000 +48/-0 hours Applied DC voltage is described in table2. Charging and discharging current shall be 50mA or less. Voltage treatment specified in No.4 of the specification shall be conducted prior to test. Measurement shall be conducted after test sample is kept for 24 ± 2 hours.
		Capacitance Change	Per Table2	
		Dissipation Factor	Per Table2	
		Insulation Resistance	Per Table2	
17	Humidity Loading	Appearance	No abnormality	Conforming to EIA RS-198-D (1991). Test sample shall be put in thermostatic oven with $40 \pm 2^\circ\text{C}$ and relative humidity 90 to 95% and DC rated voltage shall be continuously applied for 500 +24/-0 hours. Charging and discharging current shall be 50mA or less. Voltage treatment specified in No.4 of the specification shall be conducted prior to test. Measurement shall be conducted after test sample is kept for 24 ± 2 hours.
		Capacitance Change	Per Table2	
		Dissipation Factor	Per Table2	
		Insulation Resistance	Per Table2	
18	Bending Strength	Appearance	No abnormality	Test sample shall be soldered to test board as shown in Fig.3. Soldering shall be conducted with care of avoiding an abnormality such as heat shock. Deflection test is such that force to cause deflection as much as 1.0mm is applied for 10 seconds in method shown in Fig.4. Measurement shall be conducted with deflection of 1.0mm.
		Capacitance Change	Within $\pm 12.5\%$	

[part number1] [part number2] Table 1 Nominal Capacitance Range and Tolerance

part number2※1	part number1※1	Temperature characteristics (JIS/EIA)	Capacitance (μF)	DF(%max.)	Measuring condition※2	P/N1.Spec Control Code ※3	P/N2.Control Code ※3	Thickness(mm) t	Soldering method	
									Wave	Reflow
JMK212ABJ226KG		X5R	22.0	10.0	1	-	A	1.25+0.15/-0.05	x	o
	JMK212 BJ226KG	X5R	22.0	10.0	1	-		1.25±0.15	x	o

【Note】 ※1 : □ is for Tolerance code K or M.

※2 : Per P4-7,8

※3 : part number1: " -" Per Table 3, part number2: Blanks are for space

[part number1] [part number2] Table 2 Insulation Resistance /Specification for Capacitance Change and Dissipation Factor Change

Ordering code	Insulation Resistance (MΩ · μF)min ※1	Resistance to Soldering Heat/ Thermal Shock		Humidity (Steady state)			High Temperature Loading				Humidity Loading		
		Capacitance change rate(%)	DF (%max.)	Capacitance change rate(%)	DF (%max.)	IR after test (MΩ · μF min.)※2	Capacitance change rate(%)	DF (%max.)	Applied voltage (%) ※4	IR after test (MΩ · μF min.) ※2	Capacitance change rate(%)	DF (%max.)	IR after test (MΩ · μF min.)※3
JMK212ABJ226KG	100	±15.0	10.0	±30.0	20.0	10	±30.0	20.0	150	10	±30.0	20.0	5
JMK212 BJ226KG	100	±15.0	10.0	±30.0	20.0	10	±30.0	20.0	150	10	±30.0	20.0	5

Fig.1 Shape

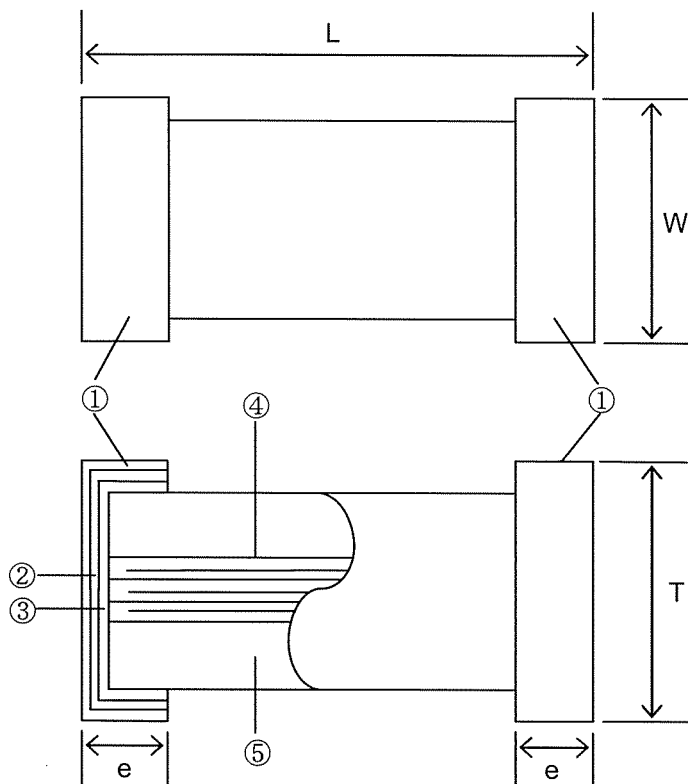

Ni Based Electrodes

No.	Name	Material
①	Terminal Electrodes (Surface)	Sn Plating
②	Terminal Electrodes	Ni Plating
		Cu Plating
③	External Electrodes	Ni
④	Internal Electrodes	Ni
⑤	Dielectric	Barium titanate

Table 3 Dimensions

[part number1] ※No spec control code for dimensions is shown in part numbers.

Type	L		W		T	e
	Spec Control Code※	Dimensions	Spec Control Code※	Dimensions	Dimensions	Dimensions
212	—	2.0±0.15	—	1.25±0.15	Per Table1	0.5±0.25

[Unit: mm]

[part number2]

※Dimensions below are applicable to all products except low-profile products.

Only LW dimensions are applicable to low-profile products.

Type	L		W		T		e
	Control Code	Dimensions	Control Code	Dimensions	Control Code	Dimensions	Dimensions
212	A	2.0+0.15/-0.05	A	1.25+0.15/-0.05	A	Per Table1	0.5±0.25

[Unit: mm]

Fig.2 Board / Test Jig of Adhesive Force of Terminal Electrodes, Vibration and Thermal Shock

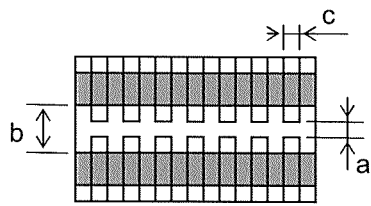

Size (L×W)	a	b	c
2.0×1.25	1.2	4.0	1.65

[Unit: mm]

Material: Glass epoxy board [JIS C 6484]

- Copper foil (Thickness: 0.035mm)
- Solder resist

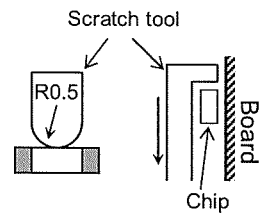

Cross Section

Remarks: Uniform soldering shall be conducted with solder (H60A or H63A in JIS Z 3282) by using an iron or soldering oven.

Soldering shall be conducted with care of avoiding abnormality such as heat shock.

Fig.3 Test Board

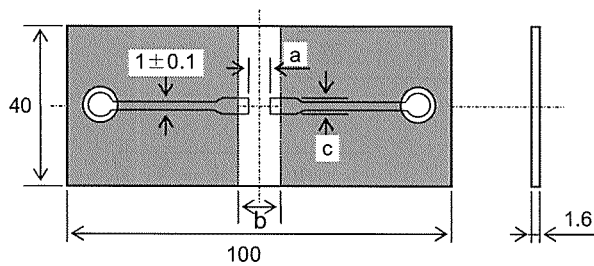

Material: Glass epoxy board [JIS C 6484]

- Copper foil (Thickness: 0.035mm)
- Solder resist

Size (L×W)	a	b	c
2.0×1.25	1.2	4.0	1.65

[Unit: mm]

Fig.4

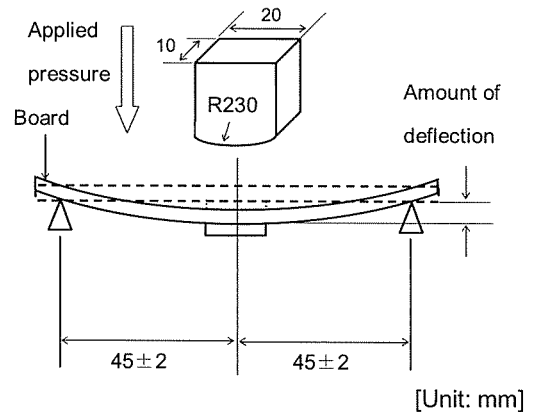

Apply pressure at the rate of 0.5mm/sec. until amount of deflection reaches 1.0mm.

Tape Packaging 107 · 212 · 316 · 325 Type

Ⓞ In case of taping packing, paper tapes shall be used for 107 type product and product with 0.85mm thickness, embossed tapes shall be used for product with thickness rank of 1.15mm, 1.25mm, 1.5mm, 1.6mm, 1.9mm, 2.5mm and 325 Type with 0.85mm rank thickness.

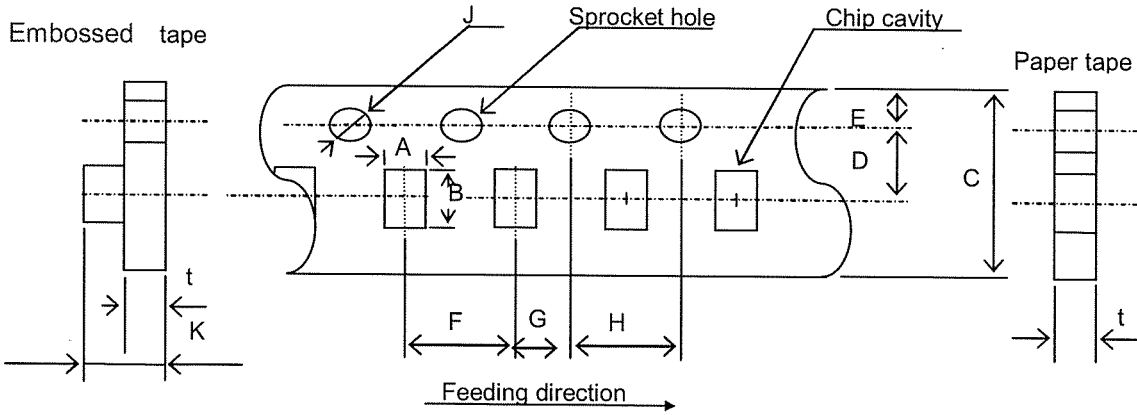

Dimensions※1

[Unit: mm]

Type	A	B
107	1.0 ± 0.2	1.8 ± 0.2
	1.1 ± 0.2 ※2	1.9 ± 0.2 ※2
212	1.65 ± 0.2	2.4 ± 0.2

Type	A	B
316	2.0 ± 0.2	3.6 ± 0.2
325	2.8 ± 0.2	3.6 ± 0.2

Dimensions

[Unit: mm]

Type	C	D	E	F	G	H	J	K※1	t※1
107~ 325	8.0 ± 0.3	3.5 ± 0.05	1.75 ± 0.1	4.0 ± 0.1	2.0 ± 0.05	4.0 ± 0.1	$\phi 1.5$ $+0.1/-0$	- (Paper tape)	1.1 max (Paper tape)
									1.2 max (Paper tape) ※2
								3.4 max	0.6 max

※1 A, B, K, t : Sufficient clearance.

※2 LMK107BBJ475MKLT, LMK107BBJ106MALT, AMK107BBJ226MA-T
LMK107 BJJ475MKLTD, LMK107 BJJ106MALTD, AMK107 BJJ226MA-T

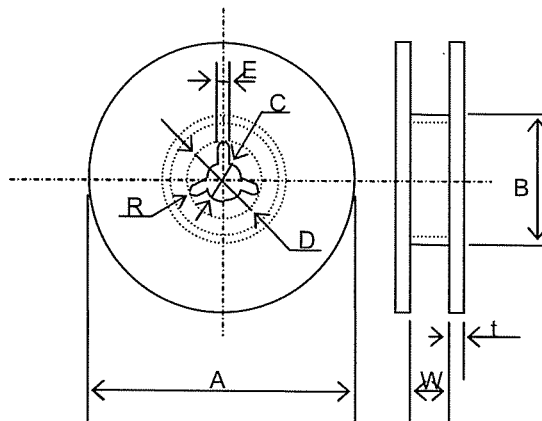

Dimensions of Reel [Unit: mm]

Type	A	B	C	D	E	W	t	R
107~325	$\phi 178 \pm 2.0$	$\phi 50$ min	$\phi 13.0 \pm 0.2$	$\phi 21.0 \pm 0.8$	2.0 ± 0.5	10.0 ± 1.5	2.5max.	1.0

Tape Packaging 107,212,316,325 TYPE

- Taping shall be right-sided wound. When the end is pulled out, sprocket hole will be at the right-hand side.
- The "t" dimension axis and "W" dimension axis of the following components inserted in chip cavity shall be randomly perpendicular to tape face.

107(0603) type with 0.8mm rank thickness, 212(0805) type with 1.25mm rank thickness,
316(1206) type with 1.6mm rank thickness, 325(1210) type with 2.5mm rank thickness

- For packaging chips by taping, blank spaces are provided on taping as shown in the figure.

- Leader part 400mm min.
- Leader part (Blank part) 100mm min.
- Trailer (Blank part) 160mm min.

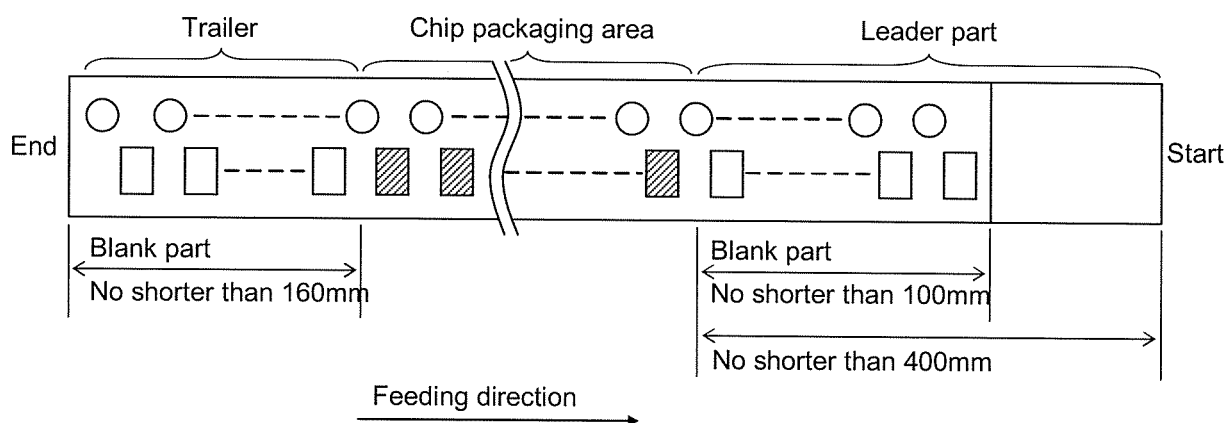

- Neither top/bottom tapes of paper tape nor top tape of embossed tape shall cover sprocket holes.
- There shall no seam on paper tape and embossed tape.
- Tensile strength of the tape shall be 5N(0.51kgf) or over.
- Number of the chip missing at Chip packaging area shall be 1 piece maximum per reel.
- Standard number of chips contained in a reel shall be per Table shown below.
- Label indicating part No., quantity and control No. shall be attached to the outside of reel.
- Peeling strength of top tape shall be 0.1 to 0.7N (10.2 to 71.4gf) when top tape is peeled from carrier tape at an angle of 0 to 20 degrees.

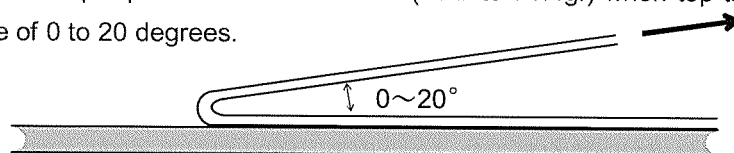

Quantity of taping package

Type	Thickness (rank) Unit: mm	Quantity (pcs/reel)	Carrier tape
107	0.45(K)	4,000	paper
	0.80(A)		
212	0.45(K)	3,000	embossed(plastic)
	0.85(D)		
316	1.25(G)	4,000	paper
	0.85(D)		
	1.60(L)		
316	1.15(F)	3,000	embossed(plastic)
	1.25(G)		
	1.60(L)	2,000	

Type	Thickness (rank) Unit: mm	Quantity (pcs/reel)	Carrier tape
325	0.85(D)	2,000	embossed(plastic)
	1.15(F)		
	1.50(H)		
	1.90(N)		
	1.9+0.1/-0.2(Y)		
	2.50(M)※	500or1000	

※For 325 type/2.50(M) thickness products, "-T" means 500 pcs per reel and "-P" means 1000 pcs per reel.

Tape Packaging 107,212,316,325TYPE

[Packaging Mode]

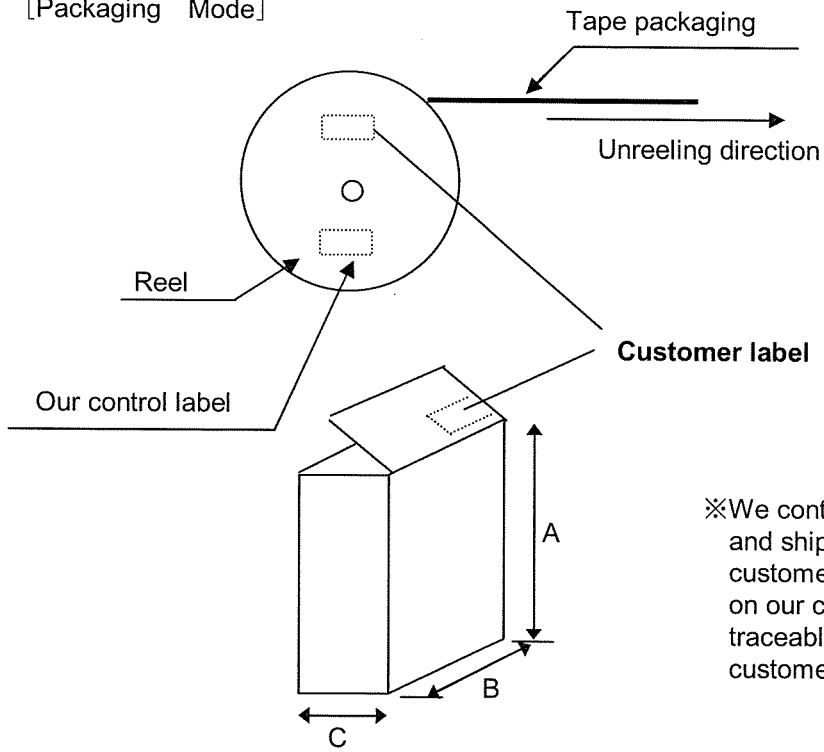

Customer Label contents

1. Manufacturer Name
2. Customer Parts No.
3. Our parts no.
4. Quantity
5. Control No.
(Shipping lot number) ※
6. Manufacturing site
MADE IN ○○○

※We control our products by control number, and shipping lot numbering is not marked on customer label. Shipping lot number is marked on our control label. Shipping lot number is traceable from our control number marked on customer label

[107,212,316,325]

Code	A	B	C	Reel
Size	190	185	70	5 reels max.
			140	10 reels max.

Material: Paper

[Unit: mm]

(The size is only for reference.)

Packaging unit: Maximum 5 reels or 10 reels in a box

· To attach labels means that all products are passed.

Shipping Lot No.

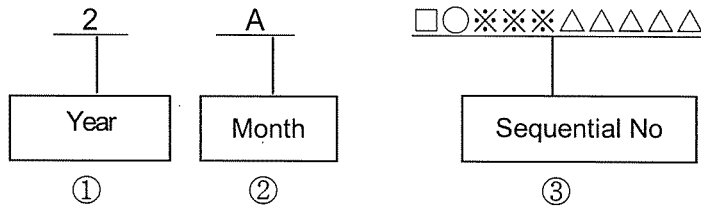

- ① First digit of manufactured year Example: 2012year → 2
- ② Manufactured month and its symbol are described in below table.
- ③ Sequential number is consist of alphabet, numeric and space.

Month	1	2	3	4	5	6	7	8	9	10	11	12
code	A	B	C	D	E	F	G	H	J	K	L	M

Recommended Soldering Profiles for Lead-free Solder Paste

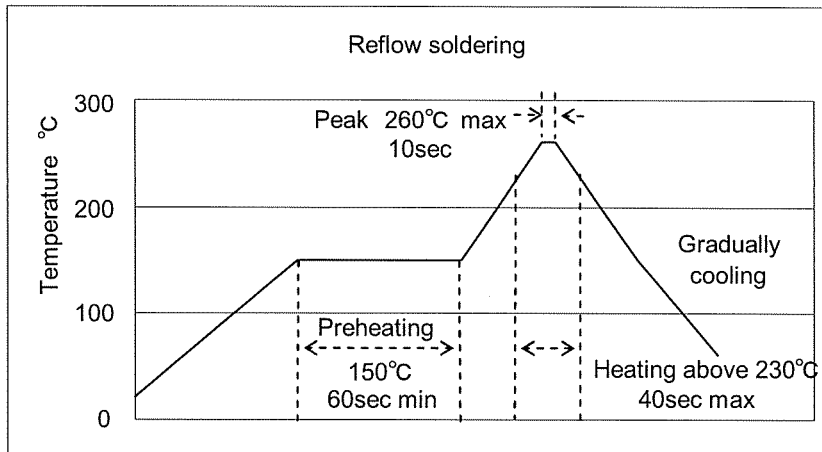

- ※Ceramic chip components should be preheated to within **100 to 130°C** from the soldering temperature.
- ※Assured to be reflow soldering for **2 times**.

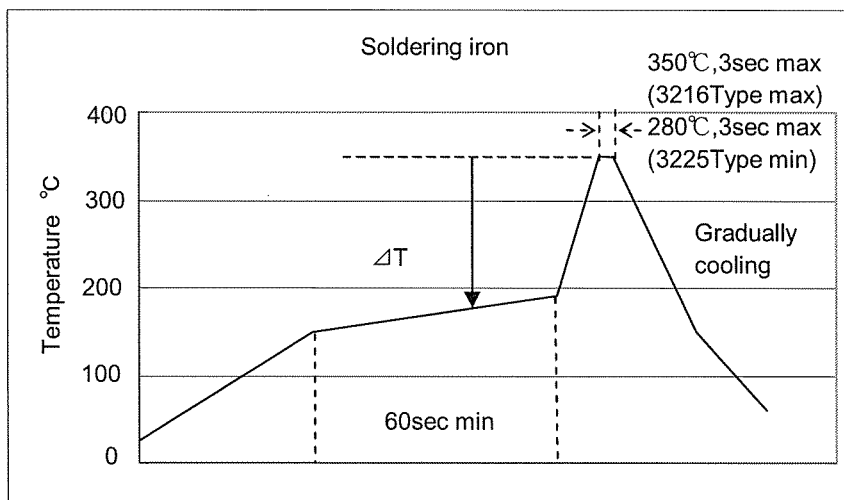

- ※ $\Delta T \leq 150^\circ\text{C}$ (3216 Type max) , $\Delta T \leq 130^\circ\text{C}$ (3225 Type min)
- ※Preheating control: Boards and components should be preheated sufficiently with temperature over 150°C, and soldering should be conducted by soldering iron while temperature of boards and components keep sufficient temperature.
- ※The soldering iron should not directly touch the components.
- ※Assured to be soldering iron for **1 time**.
- ※It is recommended to use 20W soldering iron and the tip is 1 ϕ or less.

Temperature in usage of Pb-free solder (Sn-3Ag-0.5Cu)

Case size	Soldering iron tip temp.	Preheating temp.
3216 type max.	$\leq 350^\circ\text{C}$	$\geq 150^\circ\text{C}$
3225 type min.	$\leq 280^\circ\text{C}$	$\geq 150^\circ\text{C}$

Note: The above profiles are the maximum allowable soldering condition, therefore these profiles are not always recommended.

Operating conditions for guarantee of this product are as shown in the specification.

Please note that Taiyo Yuden Co., Ltd. shall not be responsible for a failure and/or abnormality which are caused by use under the conditions other than aforesaid operating conditions.

■ All electronic components listed in this specification are developed, designed and intended for use in general electronics equipment.(for AV, office automation, household, office supply, information service, telecommunications, (such as mobile phone or PC) etc.). Before incorporating the components or devices into any equipment in the field such as transportation, (automotive control, train control, ship control), transportation signal, disaster prevention, medical, public information network(telephone exchange, base station) etc. which may have direct influence to harm or injure a human body, please contact Taiyo Yuden Co., Ltd. for more detail in advance.

Do not incorporate the products into any equipment in fields such as aerospace, aviation, nuclear control, submarine system, military, etc. where higher safety and reliability are especially required. In addition, even electronic components or functional modules that are used for the general electronic equipment, if the equipment or the electric circuit require high safety or reliability function or performances, a sufficient reliability evaluation check for safety shall be performed before commercial shipment and moreover, due consideration to install a protective circuit is strongly recommended at customer's design stage.

■ Please conduct validation and verification of products in actual condition of mounting and operating environment before commercial shipment of the equipment.

■ The contents of this specification are applicable to the products which are purchased from our sales offices or distributors (so called TAIYO YUDEN's official sales channel).

It is only applicable to the products purchased from any of TAIYO YUDEN's official sales channel.



■ Please note that Taiyo Yuden Co., Ltd. shall have no responsibility for any controversies or disputes that may occur in connection with a third party's intellectual property rights and other related rights arising from your usage of products in this specification. Taiyo Yuden Co., Ltd. grants no license for such rights.

■ Caution for export

Certain items in this specification may require specific procedures for export according to Foreign Exchange and Foreign Trade Control Law of Japan, U.S. Export Administration Regulations, and other applicable regulations. Should you have any question or inquiry on this matter, please contact our sales staff.

Looking for pricing, stock, or lifecycle information?

Click below to explore more details on WIN SOURCE:

-  [View JMK212BJ226KG-T on WIN SOURCE](#)
-  [Taiyo Yuden Information](#)

Optimize Your Supply Chain with WIN SOURCE Solutions

-  Global Sourcing Solution
-  Obsolete Management
-  Cost Control Management
-  Shortage Management
-  Alternative Solution
-  Excess Inventory Management