



**THE DATASHEET OF
ADP3301ARZ-5-REEL**



ADP3301

FEATURES

- High Accuracy (Over Line and Load Regulations at +25°C): $\pm 0.8\%$
- Ultralow Dropout Voltage: 100 mV Typical @ 100 mA
- Requires Only $C_O = 0.47 \mu\text{F}$ for Stability
- anyCAP™* = Stable with All Types of Capacitors
- Current and Thermal Limiting
- Low Noise
- Dropout Detector
- Low Shutdown Current: $1 \mu\text{A}$
- Several Fixed Voltage Options
- 3.0 V to 12 V Supply Range
- 20°C to +85°C Ambient Temperature Range
- Thermally Enhanced SO-8 Package
- Excellent Line and Load Regulations

APPLICATIONS

- Cellular Telephones
- Notebook, Palmtop Computers
- Battery Powered Systems
- Portable Instruments
- Post Regulator for Switching Supplies
- Bar Code Scanners

GENERAL DESCRIPTION

The ADP3301 is a member of the ADP330x family of precision low dropout anyCAP™* voltage regulators. The ADP3301 stands out from the conventional LDOs with a novel architecture, an enhanced process and a new package. Its patented design includes a noninverting wideband driver and a stage that permits the use of an internal "pole splitting" capacitor to stabilize the feedback loop with a single output capacitor as small as $0.47 \mu\text{F}$. This device is stable with any type of capacitor regardless of its ESR (Equivalent Serial Resistance) value, including ceramic types (MLCC) for space restricted applications. The ADP3301 achieves exceptional accuracy of $\pm 0.8\%$ at room temperature and $\pm 1.4\%$ overall accuracy over temperature, line and load regulations. The dropout voltage of the ADP3301 is only 100 mV (typical) at 100 mA.

In addition to the new architecture and process, ADI's new proprietary thermally enhanced package (Thermal Coastline) can handle 1 W of power dissipation without external heat sink or large copper surface on the PC board. This keeps PC board real estate to a minimum and makes the ADP3301 very attractive for use in portable equipment.

*anyCAP is a trademark of Analog Devices Inc.

REV. A

Information furnished by Analog Devices is believed to be accurate and reliable. However, no responsibility is assumed by Analog Devices for its use, nor for any infringements of patents or other rights of third parties which may result from its use. No license is granted by implication or otherwise under any patent or patent rights of Analog Devices.

FUNCTIONAL BLOCK DIAGRAM

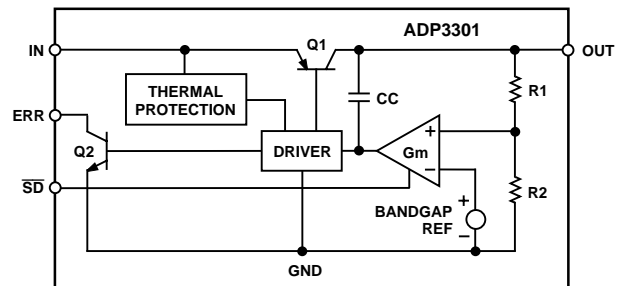

The ADP3301 operates with a wide input voltage range from 3 V to 12 V and delivers a load current in excess of 100 mA. It features an error flag that signals when the device is about to lose regulation or when the short circuit or thermal overload protection is activated. Other features include shutdown and optional noise reduction capabilities. The ADP330x anyCAP™* LDO family offers a wide range of output voltages and output current levels from 50 mA to 200 mA:

- ADP3300 (50 mA, SOT-23)
- ADP3303 (200 mA)

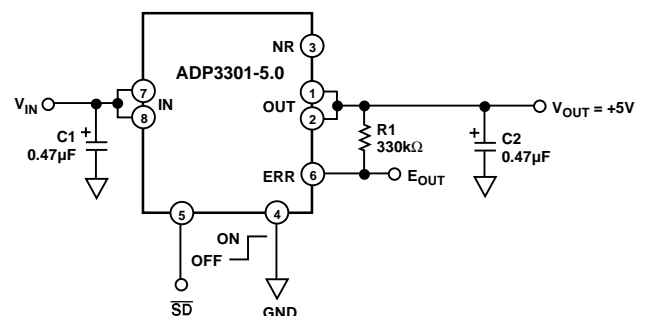

Figure 1. Typical Application Circuit

ADP3301–xx–SPECIFICATIONS

ELECTRICAL CHARACTERISTICS (@ $T_A = -20^\circ\text{C}$ to $+85^\circ\text{C}$, $V_{IN} = 7\text{ V}$, $C_{IN} = 0.47\ \mu\text{F}$, $C_{OUT} = 0.47\ \mu\text{F}$, unless otherwise noted)¹

Parameter	Symbol	Conditions	Min	Typ	Max	Units
OUTPUT VOLTAGE ACCURACY	V_{OUT}	$V_{IN} = \text{Nom } V_{OUT} + 0.3\text{ V to } 12\text{ V}$ $I_L = 0.1\text{ mA to } 100\text{ mA}$ $T_A = +25^\circ\text{C}$	-0.8		+0.8	%
		$V_{IN} = \text{Nom } V_{OUT} + 0.3\text{ V to } 12\text{ V}$ $I_L = 0.1\text{ mA to } 100\text{ mA}$	-1.4		+1.4	%
LINE REGULATION	$\frac{\Delta V_O}{\Delta V_{IN}}$	$V_{IN} = \text{Nom } V_{OUT} + 0.3\text{ V to } 12\text{ V}$ $T_A = +25^\circ\text{C}$		0.024		mV/V
LOAD REGULATION	$\frac{\Delta V_O}{\Delta I_L}$	$I_L = 0.1\text{ mA to } 100\text{ mA}$ $T_A = +25^\circ\text{C}$		0.014		mV/mA
GROUND CURRENT	I_{GND}	$I_L = 100\text{ mA}$		0.85	2	mA
		$I_L = 0.1\text{ mA}$		0.18	0.3	mA
GROUND CURRENT IN DROPOUT	I_{GND}	$V_{IN} = 2.5\text{ V}$ $I_L = 0.1\text{ mA}$		0.6	1.2	mA
DROPOUT VOLTAGE	V_{DROP}	$V_{OUT} = 98\%$ of V_O Nominal $I_L = 100\text{ mA}$		0.1	0.2	V
		$I_L = 10\text{ mA}$		0.02	0.07	V
		$I_L = 1\text{ mA}$		0.003	0.03	V
SHUTDOWN THRESHOLD	V_{THSD}	ON	2.0	0.9		V
		OFF		0.9	0.3	V
SHUTDOWN PIN INPUT CURRENT	I_{SDIN}	$0 < V_{SD} < 5\text{ V}$			1	μA
		$5 \leq V_{SD} \leq 12\text{ V @ } V_{IN} = 12\text{ V}$			22	μA
GROUND CURRENT IN SHUTDOWN MODE	I_Q	$V_{SD} = 0$, $V_{IN} = 12\text{ V}$ $T_A = +25^\circ\text{C}$			1	μA
		$V_{SD} = 0$, $V_{IN} = 12\text{ V}$ $T_A = +85^\circ\text{C}$			5	μA
OUTPUT CURRENT IN SHUTDOWN MODE	I_{OSD}	$T_A = +25^\circ\text{C @ } V_{IN} = 12\text{ V}$			2	μA
		$T_A = +85^\circ\text{C @ } V_{IN} = 12\text{ V}$			4	μA
ERROR PIN OUTPUT LEAKAGE	I_{EL}	$V_{EO} = 5\text{ V}$			13	μA
ERROR PIN OUTPUT "LOW" VOLTAGE	V_{EOL}	$I_{SINK} = 400\ \mu\text{A}$		0.13	0.3	V
PEAK LOAD CURRENT	I_{LDPK}	$V_{IN} = \text{Nom } V_{OUT} + 1\text{ V}$		200		mA
THERMAL REGULATION	$\frac{\Delta V_O}{V_O}$	$V_{IN} = 12\text{ V}$, $I_L = 100\text{ mA}$ $T = 10\text{ ms}$		0.015		%/W
OUTPUT NOISE @ 5 V OUTPUT	V_{NOISE}	$f = 10\text{ Hz-}100\text{ kHz}$ $C_{NR} = 0$		100		$\mu\text{V rms}$
		$C_{NR} = 10\text{ nF}$, $C_L = 10\ \mu\text{F}$		30		$\mu\text{V rms}$

NOTES

¹Ambient temperature of $+85^\circ\text{C}$ corresponds to a typical junction temperature of $+125^\circ\text{C}$ under typical full load test conditions.

Specifications subject to change without notice.

ABSOLUTE MAXIMUM RATINGS*

Input Supply Voltage	-0.3 V to +16 V
Shutdown Input Voltage	-0.3 V to +16 V
Error Flag Output Voltage	-0.3 V to +16 V
Noise Bypass Pin Voltage	-0.3 V to +5 V
Power Dissipation	Internally Limited
Operating Ambient Temperature Range	-55°C to +125°C
Operating Junction Temperature Range	-55°C to +125°C
θ_{JA}	96°C/W
θ_{JC}	55°C/W
Storage Temperature Range	-65°C to +150°C
Lead Temperature Range (Soldering 10 sec)	+300°C
Vapor Phase (60 sec)	+215°C
Infrared (15 sec)	+220°C

*This is a stress rating only; functional operation of the device at these or any other conditions above those indicated in the operation section of this specification is not implied. Exposure to absolute maximum rating conditions for extended periods may affect device reliability.

PIN FUNCTION DESCRIPTIONS

Pin	Mnemonic	Function
1 & 2	OUT	Output of the Regulator, fixed 2.7, 3.0, 3.2, 3.3 or 5 volts output voltage. Bypass to ground with a 0.47 μ F or larger capacitor. Pins 1 and 2 must be connected together for proper operation.
3	NR	Noise Reduction Pin. Used for further reduction of the output noise. (See text for details.) No connection if not used.
4	GND	Ground Pin.
5	\overline{SD}	Active Low Shutdown Pin. Connect to ground to disable the regulator output. When shutdown is not used, this pin should be connected to the input pin.
6	ERR	Open Collector Output which goes low to indicate that the output is about to go out of regulation.
7 & 8	IN	Regulator Input. Pins 7 and 8 must be connected together for proper operation.

Other Members of anyCAP™* Family¹

Model	Output Current	Package Option ²	Comments
ADP3300	50 mA	SOT-23	High Accuracy
ADP3303	200 mA	SO-8	High Accuracy

NOTES

¹See individual data sheets for detailed ordering information.

²SO = Small Outline, SOT = Surface Mount.

PIN CONFIGURATION

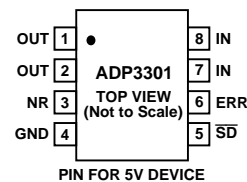

CAUTION

ESD (electrostatic discharge) sensitive device. Electrostatic charges as high as 4000 V readily accumulate on the human body and test equipment and can discharge without detection. Although the ADP3301 features proprietary ESD protection circuitry, permanent damage may occur on devices subjected to high energy electrostatic discharges. Therefore, proper ESD precautions are recommended to avoid performance degradation or loss of functionality.



ADP3301–Typical Performance Characteristics

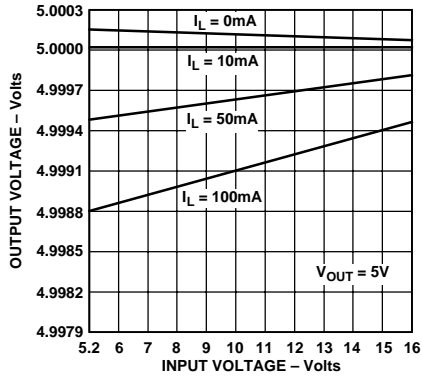

Figure 2. Line Regulation: Output Voltage vs. Input Voltage

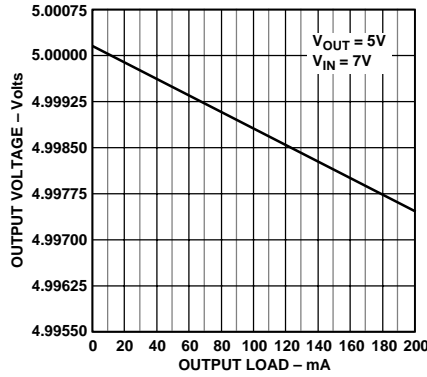

Figure 3. Output Voltage vs. Load Current Up to 200 mA

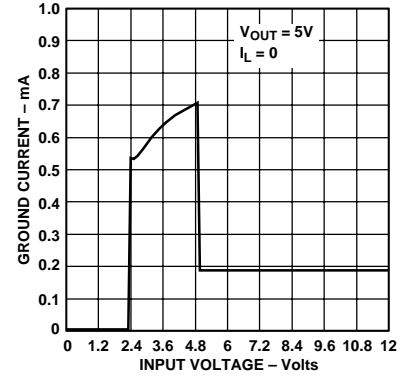

Figure 4. Quiescent Current vs. Supply Voltage

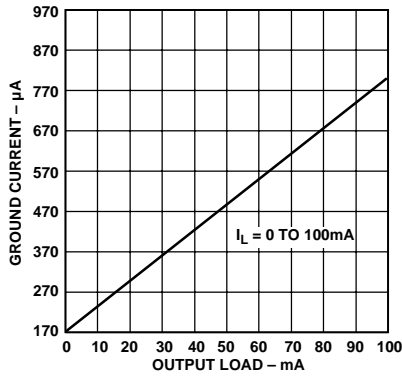

Figure 5. Quiescent Current vs. Load Current

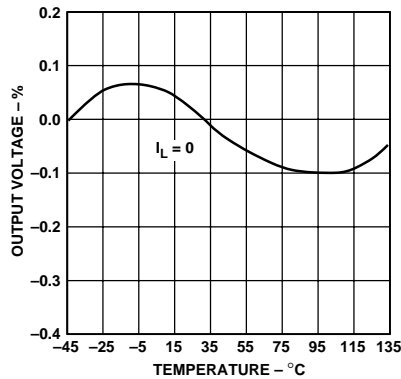

Figure 6. Output Voltage Variation % vs. Temperature

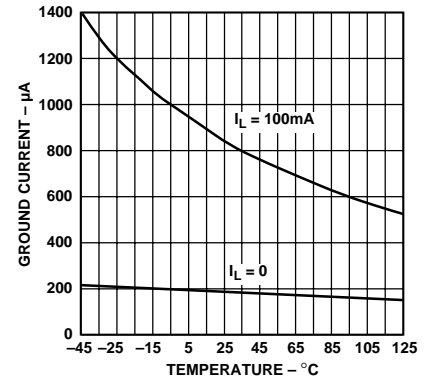

Figure 7. Quiescent Current vs. Temperature

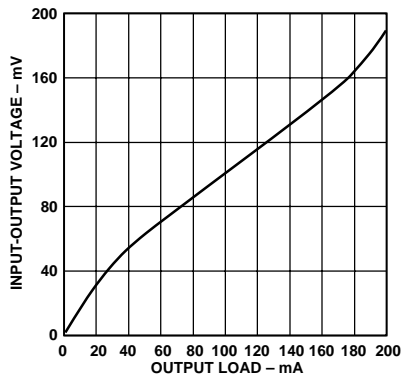

Figure 8. Dropout Voltage vs. Output Current

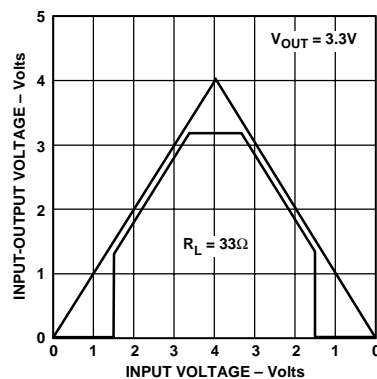

Figure 9. Power-Up/Power-Down

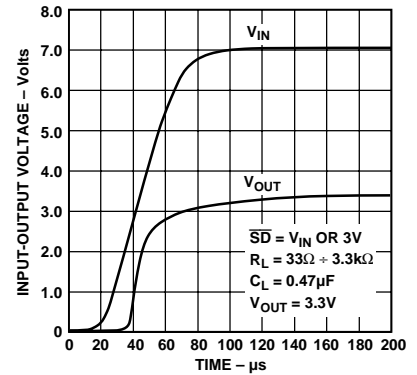

Figure 10. Power-Up Overshoot

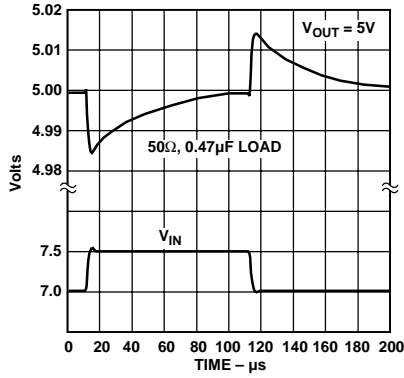

Figure 11. Line Transient Response

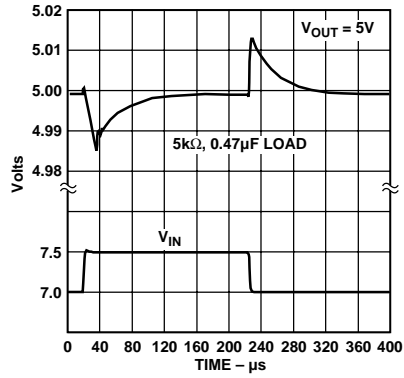

Figure 12. Line Transient Response

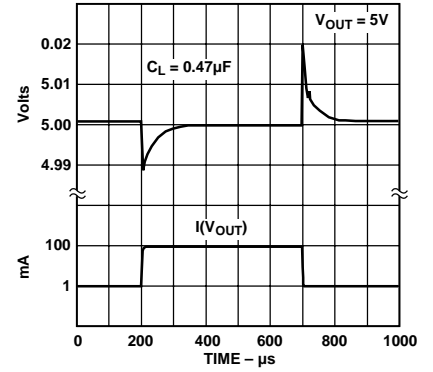

Figure 13. Load Transient for 1 mA to 100 mA Pulse

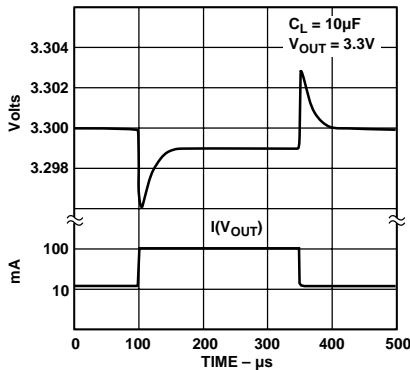

Figure 14. Load Transient for 10 mA to 100 mA Pulse

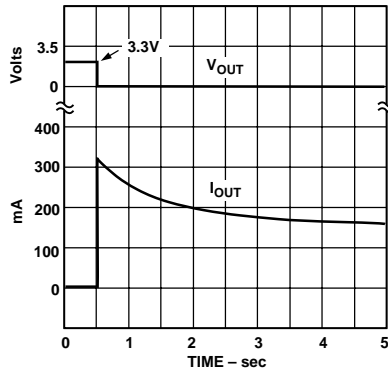

Figure 15. Short Circuit Current

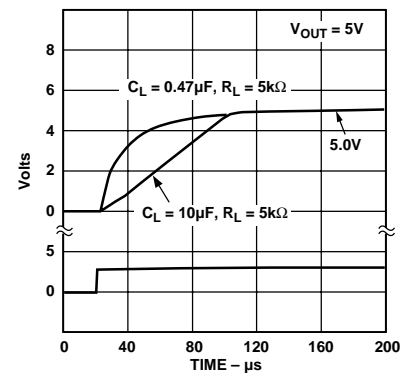

Figure 16. Turn-On

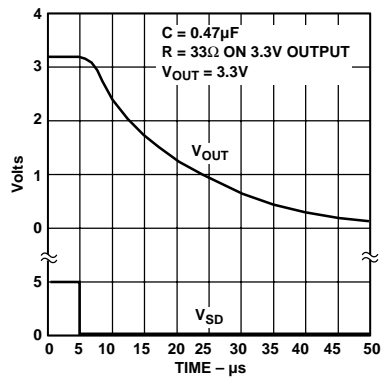

Figure 17. Turn-Off

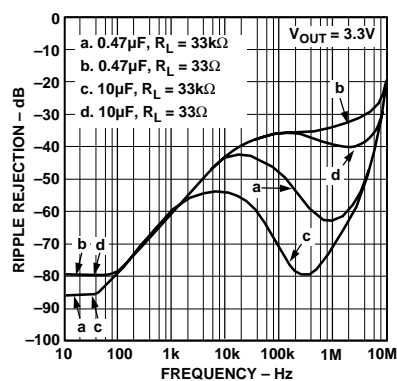

Figure 18. Power Supply Ripple Rejection

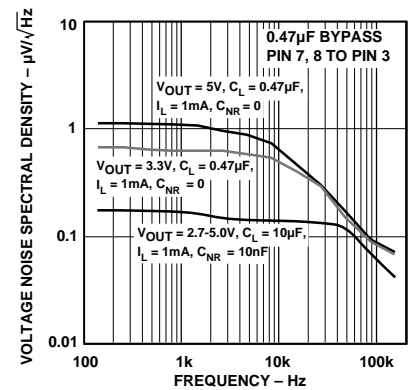

Figure 19. Output Noise Density

ADP3301

APPLICATION INFORMATION

anyCAP™*

The ADP3301 is very easy to use. The only external component required for stability is a small 0.47 μF bypass capacitor on the output. Unlike the conventional LDO designs, the ADP3301 is stable with virtually any type of capacitors (anyCAP™*) independent of the capacitor's ESR (Effective Series Resistance) value. In a typical application, if the shutdown feature is not used, the shutdown pin (Pin 5) should be tied to the input pin. Pins 7 and 8 must be tied together, as well as Pins 1 and 2, for proper operation.

Capacitor Selection

Output Capacitors: as with any micropower device, output transient response is a function of the output capacitance. The ADP3301 is stable with a wide range of capacitor values, types and ESR (anyCAP™*). A capacitor as low as 0.47 μF is all that is needed for stability. However, larger capacitors can be used if high output current surges are anticipated. The ADP3301 is stable with extremely low ESR capacitors ($\text{ESR} \approx 0$), such as multilayer ceramic capacitors (MLCC) or OSCON.

Input Bypass Capacitor: an input bypass capacitor is not required; however, for applications where the input source is high impedance or far from the input pins, a bypass capacitor is recommended. Connecting a 0.47 μF capacitor from the input pins (Pins 7 and 8) to ground reduces the circuit's sensitivity to PC board layout. If a bigger output capacitor is used, the input capacitor should be 1 μF minimum.

Low ESR capacitors offer better performance on a noisy supply; however, for less demanding requirements a standard tantalum or aluminum electrolytic capacitor is adequate.

Noise Reduction

A noise reduction capacitor (C_{NR}) can be used to further reduce the noise by 6 dB–10 dB (Figure 20). Low leakage capacitors in the 10 nF–100 nF range provide the best performance. Since the noise reduction pin (NR) is internally connected to a high impedance node, any connection to this node should be carefully done to avoid noise pickup from external sources. The pad connected to this pin should be as small as possible. Long PC board traces are not recommended.

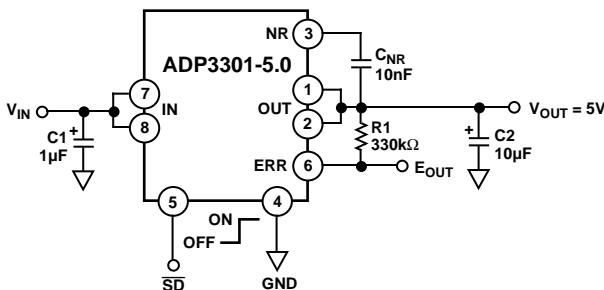

Figure 20. Noise Reduction Circuit

Thermal Overload Protection

The ADP3301 is protected against damage due to excessive power dissipation by its thermal overload protection circuit, which limits the die temperature to a maximum of 165°C. Under extreme conditions (i.e., high ambient temperature and high power dissipation) where die temperature starts to rise above 165°C, the output current is reduced until die temperature has dropped to a safe level. Output current is restored when the die temperature is reduced.

Current and thermal limit protections are intended to protect the device against accidental overload conditions. For normal operation, device power dissipation should be externally limited so that junction temperatures will not exceed 125°C.

Calculating Junction Temperature

Device power dissipation is calculated as follows :

$$PD = (V_{IN} - V_{OUT}) I_{LOAD} + (V_{IN}) I_{GND}$$

Where I_{LOAD} and I_{GND} are load current and ground current, V_{IN} and V_{OUT} are input and output voltages respectively.

Assuming $I_{LOAD} = 100 \text{ mA}$, $I_{GND} = 2 \text{ mA}$, $V_{IN} = 9 \text{ V}$ and $V_{OUT} = 5.0 \text{ V}$, device power dissipation is:

$$PD = (9 \text{ V} - 5 \text{ V}) 100 \text{ mA} + (9 \text{ V}) 2 \text{ mA} = 418 \text{ mW}$$

The proprietary package used in ADP3301 has a thermal resistance of 96°C/W, significantly lower than a standard 8-pin SOIC package at 170°C/W.

Junction temperature above ambient temperature will be approximately equal to :

$$0.418 \text{ W} \times 96^\circ\text{C/W} = 40.1^\circ\text{C}$$

To limit the maximum junction temperature to 125°C, maximum ambient temperature must be lower than:

$$T_{A(MAX)} = 125^\circ\text{C} - 40.1^\circ\text{C} = 84.9^\circ\text{C}$$

Printed Circuit Board Layout Consideration

All surface mount packages rely on the traces of the PC board to conduct heat away from the package.

In standard packages the dominant component of the heat resistance path is the plastic between the die attach pad and the individual leads. In typical thermally enhanced packages, one or more of the leads are fused to the die attach pad, significantly decreasing this component. However, to make the improvement meaningful, a significant copper area on the PCB has to be attached to these fused pins.

The ADP3301's patented thermal coastline lead frame design uniformly minimizes the value of the dominant portion of the thermal resistance. It ensures that heat is conducted away by all pins of the package. This yields a very low 96°C/W thermal resistance for an SO-8 package, without any special board layout requirements, relying on the normal traces connected to the leads. The thermal resistance can be decreased by approximately an additional 10% by attaching a few square cm of copper area to the V_{IN} pin of the ADP3301 package.

It is not recommended to use solder mask or silkscreen on the PCB traces adjacent to the ADP3301's pins since it will increase the junction to ambient thermal resistance of the package.

Shutdown Mode

Applying a TTL high signal to the shutdown pin, or tying it to the input pin, will turn the output ON. Pulling the shutdown pin low, or tying it to ground, will turn the output OFF. In shutdown mode, quiescent current is reduced to less than 1 μ A.

Error Flag Dropout Detector

The ADP3301 will maintain its output voltage over a wide range of load, input voltage and temperature conditions. If, for example, regulation is lost by reducing the supply voltage below the combined regulated output and dropout voltages, the ERR output will be activated. The ERR output is an open collector, which will be driven low.

Once set, the ERRor flag's hysteresis will keep the output low until a small margin of operating range is restored either by raising the supply voltage or reducing the load.

APPLICATION CIRCUITS

Crossover Switch

The circuit in Figure 21 shows that two ADP3301s can be used to form a mixed supply voltage system. The output switches between two different levels selected by an external digital input. Output voltages can be any combination of voltages from the Ordering Guide.

Higher Output Current

The ADP3301 can source up to 100 mA without any heatsink or pass transistor. If higher current is needed, an appropriate pass transistor can be used, as in Figure 22, to increase the output current to 1 A.

Step-Up/Step-Down Post Regulator

The circuit in Figure 23 provides a high precision, low dropout regulated output voltage. It significantly reduces the ripple from a switching regulator. The ADP3000 used in this circuit is a switching regulator in the step-up configuration.

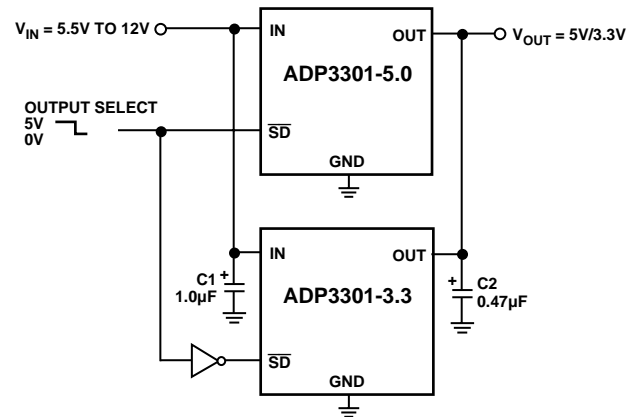
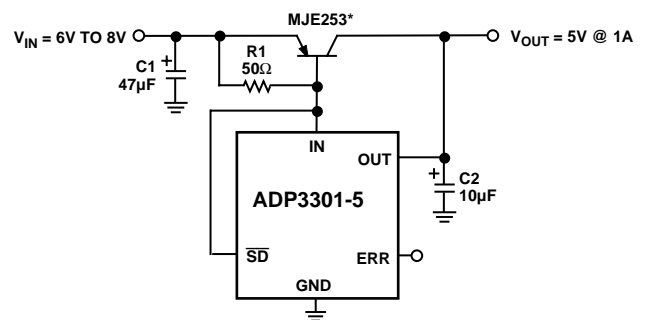

Figure 21. Crossover Switch



*AAVID531002 HEAT SINK IS USED

Figure 22. High Output Current Linear Regulator

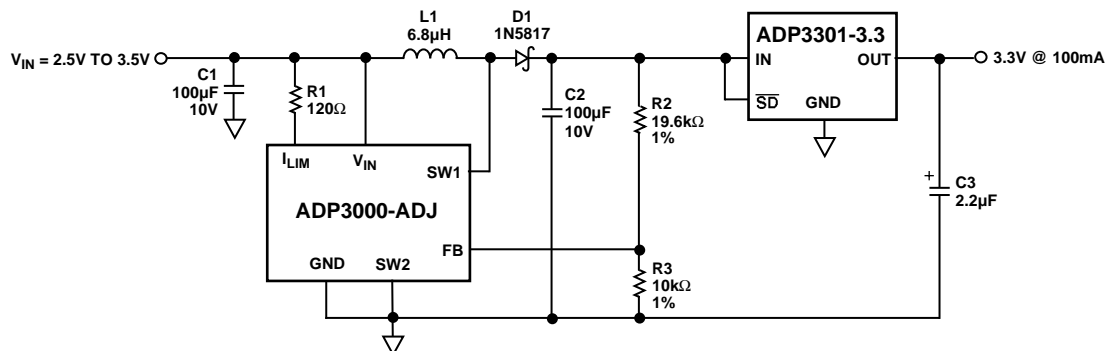
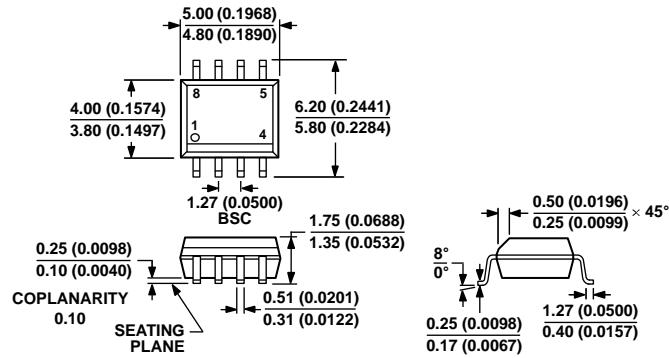

Figure 23. Step-Up/Step-Down Post Regulator

ADP3301

OUTLINE DIMENSIONS



COMPLIANT TO JEDEC STANDARDS MS-012-AA
 CONTROLLING DIMENSIONS ARE IN MILLIMETERS; INCH DIMENSIONS
 (IN PARENTHESES) ARE ROUNDED-OFF MILLIMETER EQUIVALENTS FOR
 REFERENCE ONLY AND ARE NOT APPROPRIATE FOR USE IN DESIGN.

012407-A

Figure 24. 8-Lead Standard Small Outline Package [SOIC_N]
 Narrow Body
 (R-8)

Dimensions shown in millimeters and (inches)

ORDERING GUIDE

Model ¹	Temperature Range	Output Voltage (V)	Package Option	Package Description
ADP3301AR-5-REEL	-40°C to +85°C	5	R-8	8-Lead SOIC_N
ADP3301ARZ-2.7	-40°C to +85°C	2.7	R-8	8-Lead SOIC_N
ADP3301ARZ-3	-40°C to +85°C	3	R-8	8-Lead SOIC_N
ADP3301ARZ-3-REEL	-40°C to +85°C	3	R-8	8-Lead SOIC_N
ADP3301ARZ-3.2	-40°C to +85°C	3.2	R-8	8-Lead SOIC_N
ADP3301ARZ-3.3	-40°C to +85°C	3.3	R-8	8-Lead SOIC_N
ADP3301ARZ-3.3-RL	-40°C to +85°C	3.3	R-8	8-Lead SOIC_N
ADP3301ARZ-5	-40°C to +85°C	5	R-8	8-Lead SOIC_N
ADP3301ARZ-5-REEL	-40°C to +85°C	5	R-8	8-Lead SOIC_N

¹ Z = RoHS Compliant Part.

REVISION HISTORY



2/14—Rev. 0 to Rev. A

Removed ADP3302, ADP3304, ADP3306 (Throughout) 1
 Updated Outline Dimensions..... 9
 Changes to Ordering Guide..... 9

2/97—Revision 0: Initial Version

Looking for pricing, stock, or lifecycle information?

Click below to explore more details on WIN SOURCE:

-  View [ADP3301ARZ-5-REEL](#) on WIN SOURCE
-  [Analog Devices Inc.](#) Information

Optimize Your Supply Chain with WIN SOURCE Solutions

-  Global Sourcing Solution
-  Obsolete Management
-  Cost Control Management
-  Shortage Management
-  Alternative Solution
-  Excess Inventory Management