

SL5500

SL5501

SL5504

SL5511

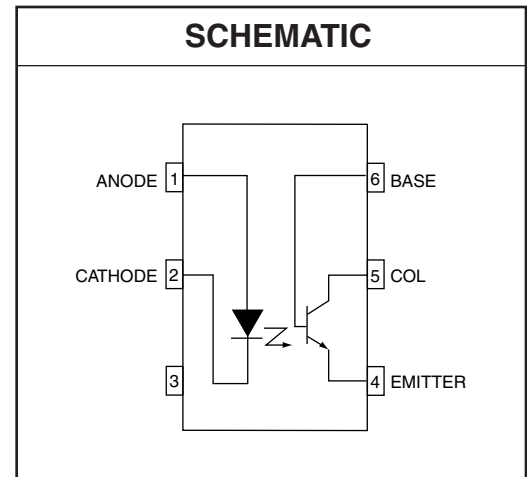
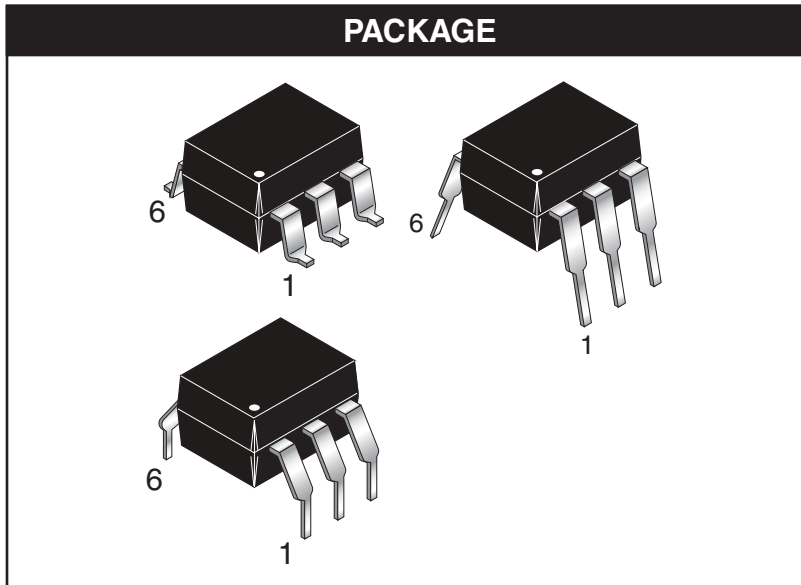

DESCRIPTION

The SL5500, SL5501, SL5504 and SL5511 are optically coupled isolators each consisting of an infrared emitting GaAs diode and a silicon NPN phototransistor with accessible base. These devices are housed in 6-pin dual-in-line packages (DIP).

FEATURES

- High output/input DC current transfer ratio
- Low saturation voltage
- High isolation voltage of 5.3 kV RMS
- UL recognized (File # E90700)
- VDE recognized (File # 94766)
- Ordering option '300' (e.g. SL5500.300)

APPLICATIONS

- Power supply regulators
- Digital logic inputs
- Microprocessor inputs
- Appliance sensor systems
- Industrial controls

SL5500

SL5501

SL5504

SL5511

Parameters		Symbol	Value	Units
TOTAL DEVICE				
Storage Temperature		T_{STG}	-55 to +150	°C
Operating Temperature		T_{OPR}	-55 to +100	°C
Lead Solder Temperature		T_{SOL}	260 for 10 sec	°C
Total Power Dissipation at $T_A = 25^\circ\text{C}$ Ambient Derate Linearly from 25°C		P_D	260	mW
			3.3	mW/°C
EMITTER				
Continuous Reverse Voltage		V_R	3	V
Continuous Forward Current		I_F	100	mA
Forward Current - Peak (10 μs pulse, $\delta = 0.01$)		$I_F(\text{pk})$	3.0	A
Total Power Dissipation $T_A = 25^\circ\text{C}$ Ambient Derate Linearly from 25°C		P_D	150	mW
			2.0	mW/°C
DETECTOR				
Collector to Emitter Voltage (open base)	SL5500, SL5501, SL5511	V_{CEO}	30	V
	SL5504		80	
Collector to Base Voltage (open emitter)	SL5500, SL5501, SL5511	V_{CBO}	70	V
	SL5504		120	
Emitter to Collector Voltage (open base)		V_{ECO}	7	V
Emitter to Base Voltage (open collector)		V_{EBO}	7	V
DC Collector Current		I_C	100	mA
Detector Power Dissipation @ $T_A = 25^\circ\text{C}$ Ambient Derate Linearly from 25°C		P_D	150	mW
			2.0	mW/°C

SL5500

SL5501

SL5504

SL5511

ELECTRICAL CHARACTERISTICS ($T_A = 25^\circ\text{C}$ Unless otherwise specified.)

INDIVIDUAL COMPONENT CHARACTERISTICS

Parameters	Test Conditions	Symbol	Device	Min	Typ*	Max	Units
EMITTER							
Input Forward Voltage	$I_F = 20\text{ mA}, T_A = 25\text{ to }70^\circ\text{C}$	V_F	All		1.23	1.3	V
	$I_F = 2\text{ mA}$				1.10	1.2	V
Reverse Current	$V_R = 3\text{ V}, T_A = 25\text{ to }70^\circ\text{C}$	I_R	All		0.001	10	μA
DETECTOR							
Leakage Current Collector to Emitter	$V_{CE} = 10\text{ V}$	I_{CEO}	All		1	50	nA
	$V_{CE} = 30\text{ V}$				0.005	10	μA
	$V_{CE} = 10\text{ V}, T_A = 70^\circ\text{C}$					500	nA
	$V_{CB} = 30\text{ V}$	I_{CBO}			0.001	50	μA
Breakdown Voltage							
Collector to Emitter	$I_C = 10\ \mu\text{A}, I_F = 0$	BV_{CEO}	SL5500, SL5501, SL5511	30	100		V
			SL5504	80	110		
Collector to Base	$I_C = 10\ \mu\text{A}, I_F = 0$	BV_{CBO}	SL5500, SL5501, SL5511	30	120		V
			SL5504	120	150		
Emitter to Collector	$I_E = 10\ \mu\text{A}, I_F = 0$	BV_{ECO}	All	7	10		V
Emitter to Base	$I_E = 10\ \mu\text{A}, I_F = 0$	BV_{EBO}	All	7	10		V

ISOLATION CHARACTERISTICS

Characteristic	Test Conditions	Symbol	Min	Typ*	Max	Units
Input-Output Isolation Voltage (note 1)	$f = 60\text{ Hz}, T = 1\text{ min.}$	V_{ISO}	5300			$V_{AC(RMS)}$
Isolation Resistance	$V_{I-O} = \pm 500\text{ VDC}$	R_{ISO}	1	10		$T\Omega$
Isolation Capacitance	$f = 1\text{ MHz}, V = 0\text{ V}$	C_{ISO}		0.6	1.3	pF

*Typical values at $T_A = 25^\circ\text{C}$

SL5500

SL5501

SL5504

SL5511

TRANSFER CHARACTERISTICS (TA = 25°C Unless otherwise specified.)

DC Characteristics	Test Conditions	Symbol	Device	Min	Typ	Max	Units
Output/Input Current Transfer Ratio	$I_F = 10 \text{ mA}, V_{CE} = 0.4 \text{ V}$	CTR	SL5500	50		300	%
	$I_F = 10 \text{ mA}, V_{CE} = 0.4 \text{ V}, T_A = 70^\circ\text{C}$		SL5500	40		300	
	$I_F = 10 \text{ mA}, V_{CE} = 0.4 \text{ V}, T_A = 25^\circ\text{C to } 70^\circ\text{C}$		SL5501, SL5504	25		400	
	$I_F = 2 \text{ mA}, V_{CE} = 5 \text{ V}$		SL5500	40			
	$I_F = 2 \text{ mA}, V_{CE} = 5 \text{ V}, T_A = 70^\circ\text{C}$		SL5500	30			
	$I_F = 2 \text{ mA}, V_{CE} = 5 \text{ V}, T_A = 25^\circ\text{C to } 70^\circ\text{C}$		SL5501, SL5504	15			
	$I_F = 2 \text{ mA}, V_{CE} = 5 \text{ V}, T_A = 25^\circ\text{C to } 70^\circ\text{C}$		SL5511	25			
	$I_F = 0.5 \text{ mA}, V_{CE} = 0.4 \text{ V}, T_A = 25^\circ\text{C to } 70^\circ\text{C}$		SL5511	20			
Collector-Emitter Saturation Voltage	$I_F = 50 \text{ mA}, I_C = 10 \text{ mA}$	$V_{CE(SAT)}$	SL5500			0.4	V
	$I_F = 20 \text{ mA}, I_C = 2 \text{ mA}$		SL5501, SL5504, SL5511			0.4	
AC Characteristics	Test Conditions	Symbol	Device	Min	Typ	Max	Units
Turn-On Time	$R_L = 1 \text{ k}\Omega, I_F = 16 \text{ mA}, V_{CC} = 5 \text{ V}$	t_{on}	SL5500, SL5501, SL5511			20	μs
			SL5504			50	
Turn-Off Time	See Fig. 1 and Fig. 2	t_{off}	SL5500, SL5501, SL5511			50	μs
			SL5504			150	

Note

1. Device considered a two-terminal device: pins 1, 2 and 3 shorted together and pins 4, 5 and 6 shorted together.

SL5500

SL5501

SL5504

SL5511

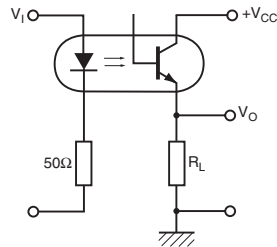

Fig. 1 Switching Circuit

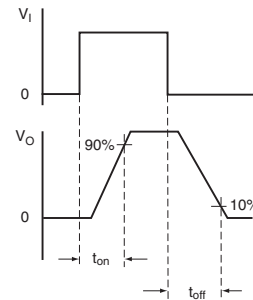

Fig. 2 Waveforms

Fig. 3 LED Forward Voltage vs. Forward Current

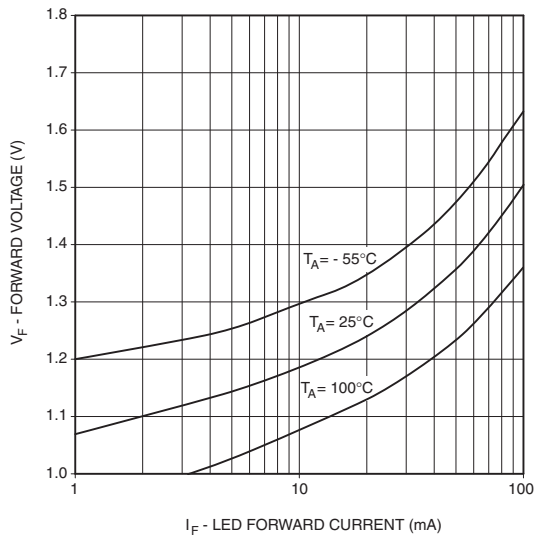

Fig. 4 Normalized CTR vs. Forward Current

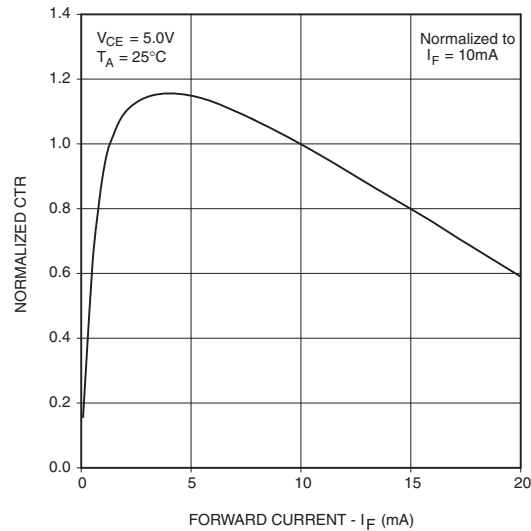

Fig. 5 Normalized CTR vs. Ambient Temperature

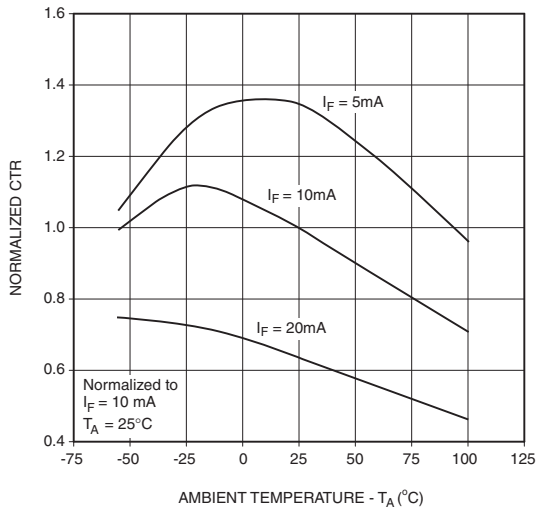
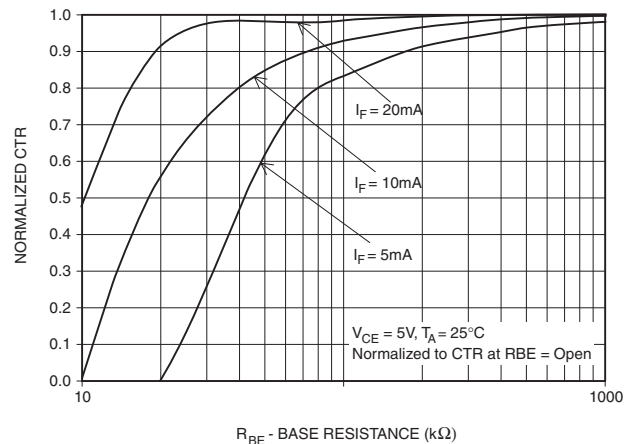

Fig. 7 CTR vs. R_{BE} (Unsaturated)



SL5500

SL5501

SL5504

SL5511

Fig. 7 CTR vs. R_{BE} (Saturated)

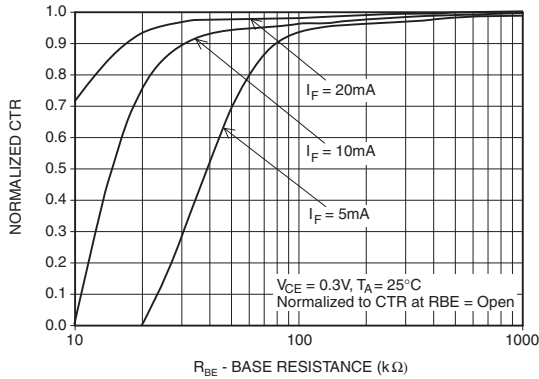

Fig. 8 Normalized t_{off} vs. R_{BE}

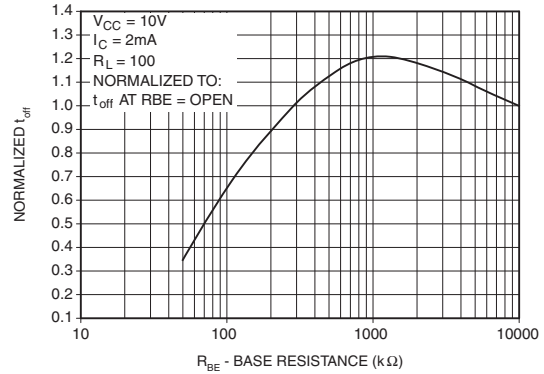

Fig. 9 Normalized t_{on} vs. R_{BE}

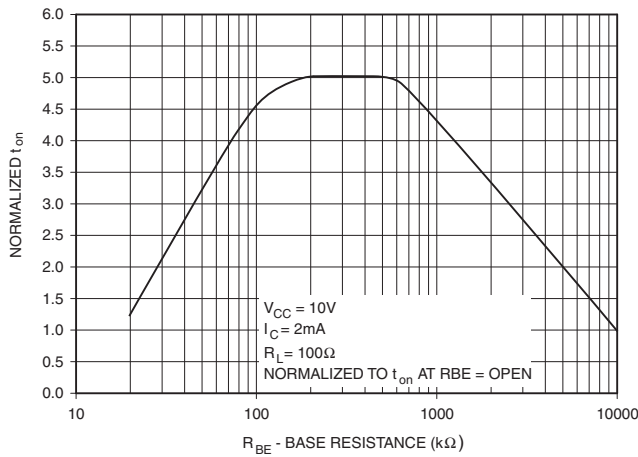

Fig. 10 Switching Speed vs. Load Resistor

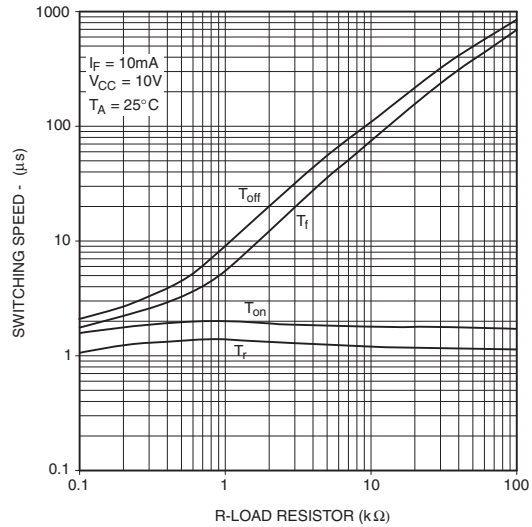

Fig. 11 Collector Emitter Saturation Voltage vs. Collector Current

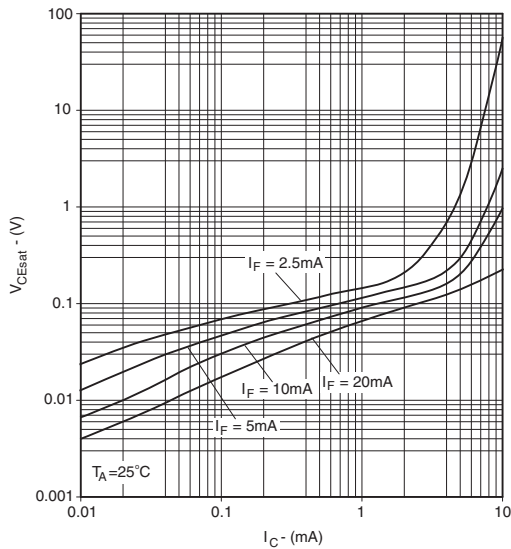
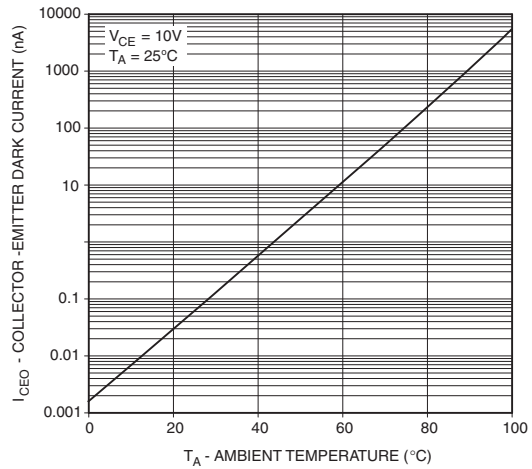

Fig. 12 Dark Current vs. Ambient Temperature



SL5500

SL5501

SL5504

SL5511

ORDERING INFORMATION

Option	Order Entry Identifier	Description
S	.S	Surface Mount Lead Bend
SD	.SD	Surface Mount; Tape and Reel
W	.W	0.4" Lead Spacing
300	.300	VDE 0884
300W	.300W	VDE 0884, 0.4" Lead Spacing
3S	.3S	VDE 0884, Surface Mount
3SD	.3SD	VDE 0884, Surface Mount, Tape and Reel

MARKING INFORMATION

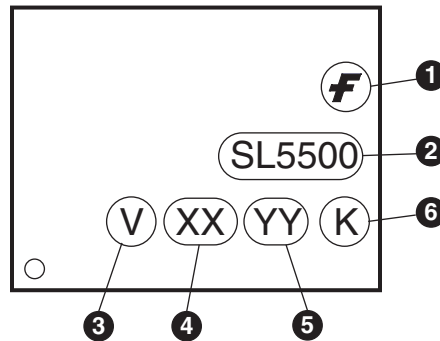

Definitions	
1	Fairchild logo
2	Device number
3	VDE mark (Note: Only appears on parts ordered with VDE option – See order entry table)
4	Two digit year code, e.g., '03'
5	Two digit work week ranging from '01' to '53'
6	Assembly package code

SL5500

SL5501

SL5504

SL5511

Carrier Tape Specifications (“D” Taping Orientation)

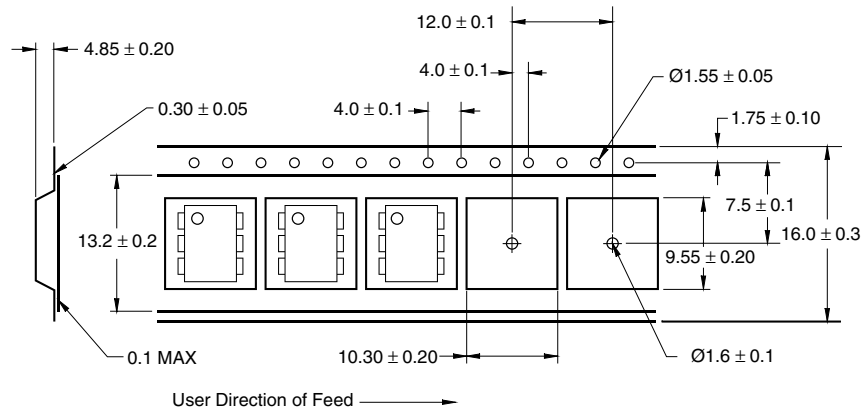

NOTE

All dimensions are in inches (millimeters)

Reflow Profile (Black Package, No Suffix)

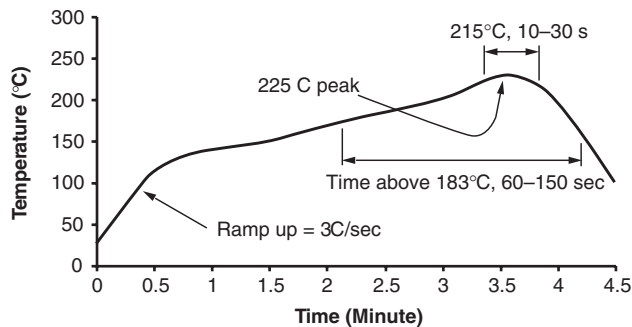

- Peak reflow temperature: 225°C (package surface temperature)
- Time of temperature higher than 183°C for 60–150 seconds
- One time soldering reflow is recommended

SL5500

SL5501

SL5504

SL5511

DISCLAIMER

FAIRCHILD SEMICONDUCTOR RESERVES THE RIGHT TO MAKE CHANGES WITHOUT FURTHER NOTICE TO ANY PRODUCTS HEREIN TO IMPROVE RELIABILITY, FUNCTION OR DESIGN. FAIRCHILD DOES NOT ASSUME ANY LIABILITY ARISING OUT OF THE APPLICATION OR USE OF ANY PRODUCT OR CIRCUIT DESCRIBED HEREIN; NEITHER DOES IT CONVEY ANY LICENSE UNDER ITS PATENT RIGHTS, NOR THE RIGHTS OF OTHERS.

LIFE SUPPORT POLICY

FAIRCHILD'S PRODUCTS ARE NOT AUTHORIZED FOR USE AS CRITICAL COMPONENTS IN LIFE SUPPORT DEVICES OR SYSTEMS WITHOUT THE EXPRESS WRITTEN APPROVAL OF THE PRESIDENT OF FAIRCHILD SEMICONDUCTOR CORPORATION. As used herein:

1. Life support devices or systems are devices or systems which, (a) are intended for surgical implant into the body, or (b) support or sustain life, and (c) whose failure to perform when properly used in accordance with instructions for use provided in the labeling, can be reasonably expected to result in a significant injury of the user.
2. A critical component in any component of a life support device or system whose failure to perform can be reasonably expected to cause the failure of the life support device or system, or to affect its safety or effectiveness.

Looking for pricing, stock, or lifecycle information?

Click below to explore more details on WIN SOURCE:

- ⊖ [View SL5500W on WIN SOURCE](#)
- ⊖ [Fairchild/ON Semiconductor Information](#)

Optimize Your Supply Chain with WIN SOURCE Solutions

- ✓ Global Sourcing Solution
- ✓ Obsolete Management
- ✓ Cost Control Management
- ✓ Shortage Management
- ✓ Alternative Solution
- ✓ Excess Inventory Management