



**THE DATASHEET OF
ADP3339AKCZ-3-RL7**



FEATURES

**High accuracy over line and load: $\pm 0.9\%$ at 25°C ,
 $\pm 1.5\%$ over temperature**
Ultralow dropout voltage: 230 mV (typical) at 1.5 A
Requires only $C_{OUT} = 1.0 \mu\text{F}$ for stability
anyCAP = stable with any type of capacitor (including MLCC)
Current and thermal limiting
Low noise
2.8 V to 6 V input voltage range
 -40°C to $+85^\circ\text{C}$ ambient temperature range
SOT-223 package

APPLICATIONS

Notebooks, palmtop computers
SCSI terminators
Battery-powered systems
PCMCIA regulators
Bar code scanners
Camcorders, cameras

GENERAL DESCRIPTION

The ADP3339 is a member of the ADP33xx family of precision, low dropout, anyCAP[®] voltage regulators. The ADP3339 operates with an input voltage range of 2.8 V to 6 V and delivers a load current up to 1.5 A. The ADP3339 stands out from the conventional LDOs with a novel architecture and an enhanced process that enables it to offer performance advantages and higher output current than its competition. Its patented design requires only a $1.0 \mu\text{F}$ output capacitor for stability. This device is insensitive to output capacitor equivalent series resistance

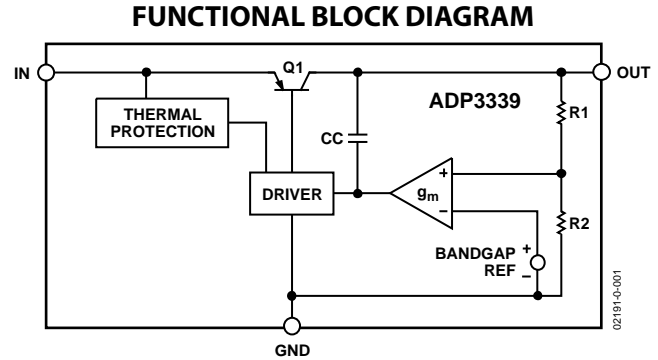

Figure 1.

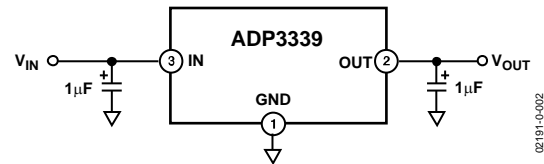

Figure 2. Typical Application Circuit

(ESR), and is stable with any good quality capacitor, including ceramic (MLCC) types for space-restricted applications. The ADP3339 achieves exceptional accuracy of $\pm 0.9\%$ at room temperature and $\pm 1.5\%$ over temperature, line, and load variations. The dropout voltage of the ADP3339 is only 230 mV (typical) at 1.5 A. The device also includes a safety current limit and thermal overload protection. The ADP3339 has ultralow quiescent current: $130 \mu\text{A}$ (typical) in light load situations.

Rev. C

Information furnished by Analog Devices is believed to be accurate and reliable. However, no responsibility is assumed by Analog Devices for its use, nor for any infringements of patents or other rights of third parties that may result from its use. Specifications subject to change without notice. No license is granted by implication or otherwise under any patent or patent rights of Analog Devices. Trademarks and registered trademarks are the property of their respective owners.

TABLE OF CONTENTS

Features	1	Theory of Operation	9
Applications	1	Applications Information	10
Functional Block Diagram	1	Capacitor Selection	10
General Description	1	Output Current Limit	10
Revision History	2	Thermal Overload Protection	10
Specifications	3	Calculating Power Dissipation	10
Absolute Maximum Ratings	4	Printed Circuit Board Layout Considerations	10
ESD Caution	4	Outline Dimensions	11
Pin Configuration and Function Descriptions	5	Ordering Guide	11
Typical Performance Characteristics	6		

REVISION HISTORY

8/11—Rev. B to Rev. C

Changes to Ordering Guide	11
---------------------------------	----

4/11—Rev. A to Rev. B

Change to Features Section	1
Changed I_L to I_{LOAD} Throughout	3
Updated Outline Dimensions	11
Changes to Ordering Guide	11

6/04—Rev. 0 to Rev. A

Updated Format	Universal
Changes to Table 1	3
Changes to Thermal Overload Protection Section	10
Updated Outline Dimensions	12
Changes to Ordering Guide	12

10/01—Revision 0: Initial Version

SPECIFICATIONS

$V_{IN} = 6.0\text{ V}$, $C_{IN} = C_{OUT} = 1\ \mu\text{F}$, $T_J = -40^\circ\text{C}$ to $+125^\circ\text{C}$, unless otherwise noted.

Table 1.

Parameter ^{1,2}	Symbol	Conditions	Min	Typ	Max	Unit
OUTPUT						
Voltage Accuracy ³	V_{OUT}	$V_{IN} = V_{OUTNOM} + 0.5\text{ V}$ to 6 V , $I_{LOAD} = 0.1\text{ mA}$ to 1.5 A , $T_J = 25^\circ\text{C}$	-0.9		+0.9	%
		$V_{IN} = V_{OUTNOM} + 0.5\text{ V}$ to 6 V , $I_{LOAD} = 0.1\text{ mA}$ to 1.5 A , $T_J = -40^\circ\text{C}$ to $+125^\circ\text{C}$	-1.5		+1.5	%
		$V_{IN} = V_{OUTNOM} + 0.5\text{ V}$ to 6 V , $I_{LOAD} = 100\text{ mA}$ to 1.5 A , $T_J = 150^\circ\text{C}$	-1.9		+1.9	%
Line Regulation ³		$V_{IN} = V_{OUTNOM} + 0.5\text{ V}$ to 6 V , $T_J = 25^\circ\text{C}$		0.04		mV/V
Load Regulation		$I_{LOAD} = 0.1\text{ mA}$ to 1.5 A , $T_J = 25^\circ\text{C}$		0.004		mV/mA
Dropout Voltage	V_{DROP}	$V_{OUT} = 98\%$ of V_{OUTNOM}				
		$I_{LOAD} = 1.5\text{ A}$		230	480	mV
		$I_{LOAD} = 1\text{ A}$		180	380	mV
		$I_{LOAD} = 500\text{ mA}$		150	300	mV
		$I_{LOAD} = 100\text{ mA}$		100		mV
Peak Load Current	I_{LDPK}	$V_{IN} = V_{OUTNOM} + 1\text{ V}$		2.0		A
Output Noise	V_{NOISE}	$f = 10\text{ Hz}$ to 100 kHz , $C_L = 10\ \mu\text{F}$, $I_{LOAD} = 1.5\text{ A}$		95		$\mu\text{V rms}$
GROUND CURRENT						
In Regulation	I_{GND}	$I_{LOAD} = 1.5\text{ A}$		13	40	mA
		$I_{LOAD} = 1\text{ A}$		9	25	mA
		$I_{LOAD} = 500\text{ mA}$		5	15	mA
		$I_{LOAD} = 100\text{ mA}$		1	3	mA
		$I_{LOAD} = 0.1\text{ mA}$		130	200	μA
In Dropout	I_{GND}	$V_{IN} = V_{OUTNOM} - 100\text{ mV}$, $I_{LOAD} = 0.1\text{ mA}$		100	300	μA

¹ All limits at temperature extremes are guaranteed via correlation using standard statistical quality control (SQC) methods.

² Application stable with no load.

³ $V_{IN} = 2.8\text{ V}$ for models with $V_{OUTNOM} \leq 2.3\text{ V}$.

ABSOLUTE MAXIMUM RATINGS

Unless otherwise specified, all voltages are referenced to GND.

Table 2.

Parameter	Rating
Input Supply Voltage	-0.3 V to +8.5 V
Power Dissipation	Internally limited
Operating Ambient Temperature Range	-40°C to +85°C
Operating Junction Temperature Range	-40°C to +150°C
θ_{JA} , 4-Layer Board	62.3°C/W
θ_{JC}	26.8°C/W
Storage Temperature Range	-65°C to +150°C
Lead Temperature (Soldering 10 sec)	300°C
Vapor Phase (60 sec)	215°C
Infrared (15 sec)	220°C

Stresses above those listed under Absolute Maximum Ratings may cause permanent damage to the device. This is a stress rating only; functional operation of the device at these or any other conditions above those listed in the operational sections of this specification is not implied. Exposure to absolute maximum rating conditions for extended periods may affect device reliability. Only one absolute maximum rating may be applied at any one time.

ESD CAUTION



ESD (electrostatic discharge) sensitive device. Charged devices and circuit boards can discharge without detection. Although this product features patented or proprietary protection circuitry, damage may occur on devices subjected to high energy ESD. Therefore, proper ESD precautions should be taken to avoid performance degradation or loss of functionality.

PIN CONFIGURATION AND FUNCTION DESCRIPTIONS

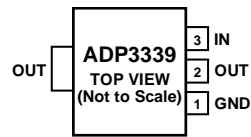

NOTES

1. PIN 2 AND OUT TAB ARE INTERNALLY CONNECTED.

02191-Q-003

Figure 3. 3-Lead SOT-223 Pin Configuration

Table 3. Pin Function Descriptions

Pin No.	Mnemonic	Description
1	GND	Ground Pin.
2	OUT	Output of the Regulator. Bypass to ground with a 1 μ F or larger capacitor.
3	IN	Regulator Input. Bypass to ground with a 1 μ F or larger capacitor.

TYPICAL PERFORMANCE CHARACTERISTICS

T_A = 25°C, unless otherwise noted.

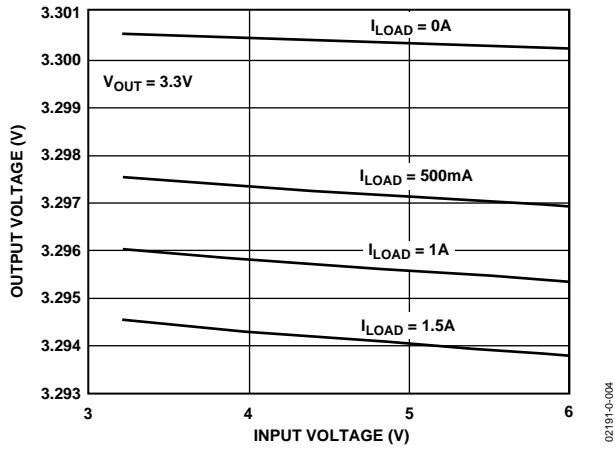

Figure 4. Output Voltage vs. Input Voltage

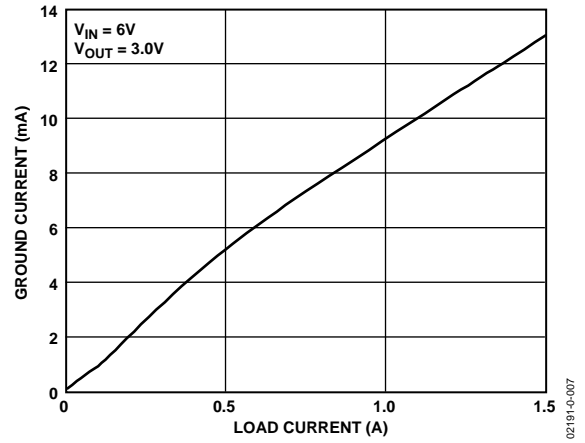

Figure 7. Ground Current vs. Load Current

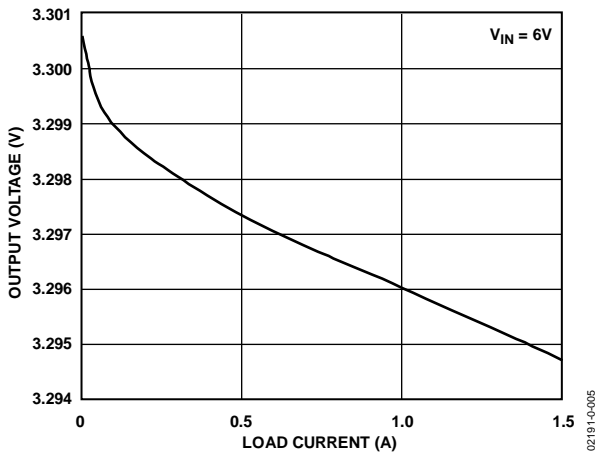

Figure 5. Output Voltage vs. Load Current

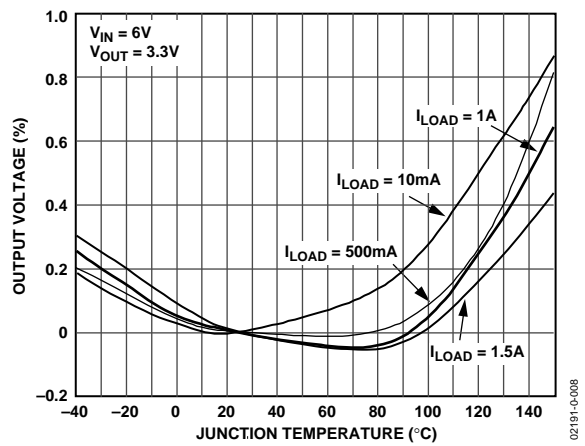

Figure 8. Output Voltage Variation Percentage vs. Junction Temperature

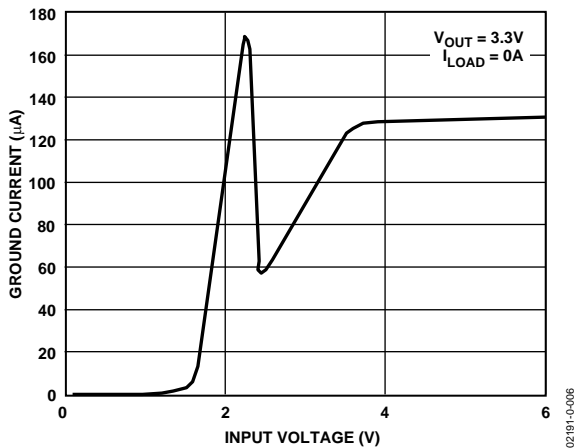

Figure 6. Ground Current vs. Supply Voltage

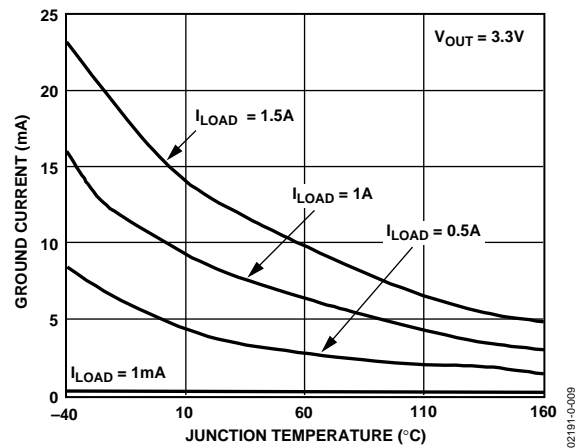

Figure 9. Ground Current vs. Junction Temperature

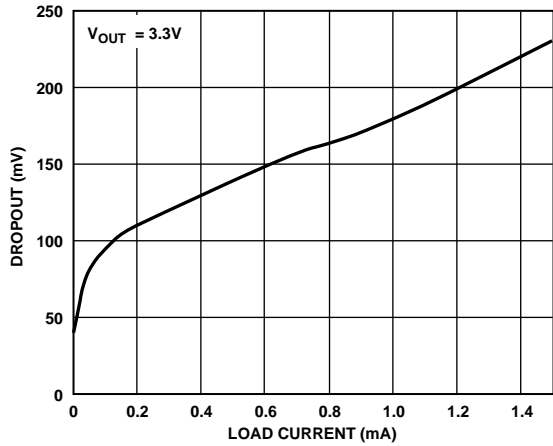

Figure 10. Dropout Voltage vs. Load Current

02191-0-010

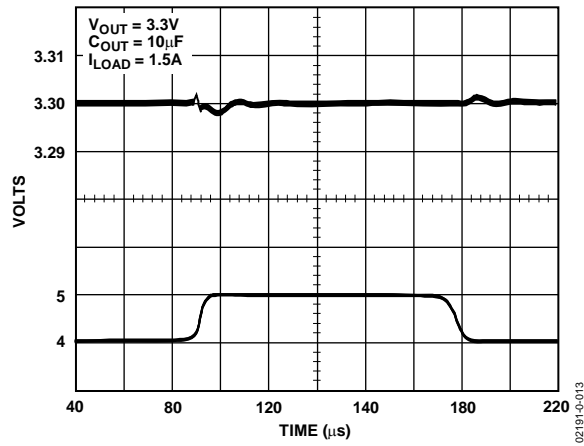

Figure 13. Line Transient Response

02191-0-013

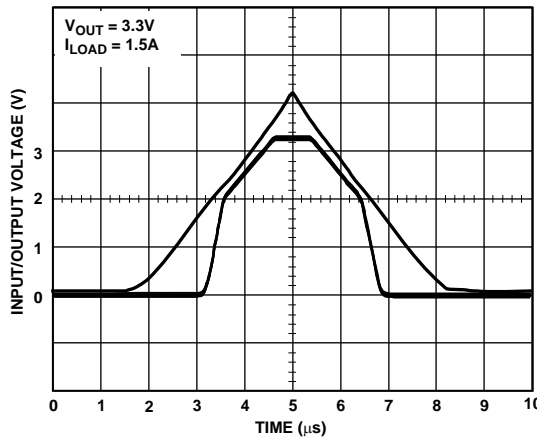

Figure 11. Power-Up/Power-Down

02191-0-011

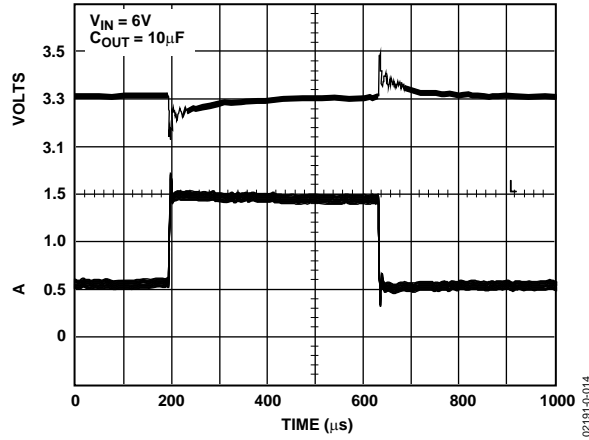

Figure 14. Load Transient Response

02191-0-014

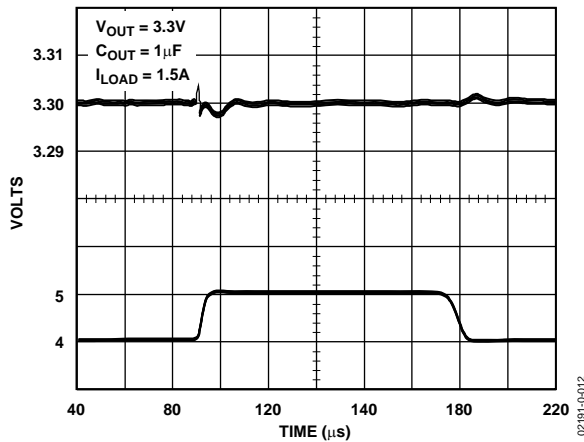

Figure 12. Line Transient Response

02191-0-012

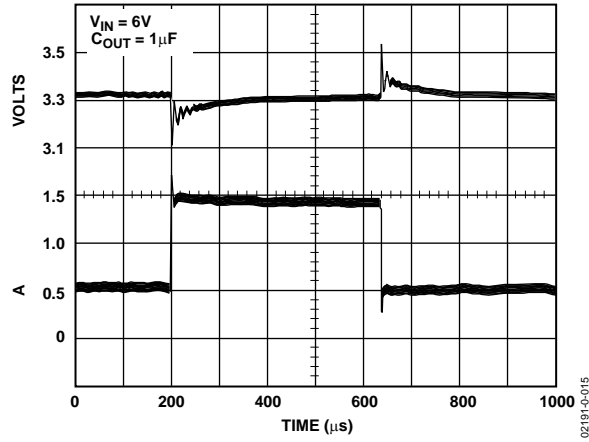

Figure 15. Load Transient Response

02191-0-015

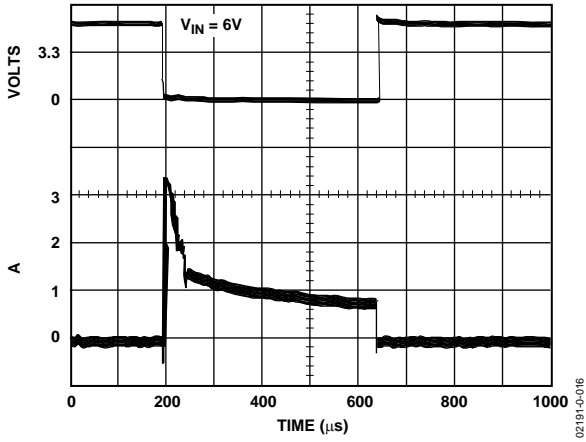

Figure 16. Short-Circuit Current

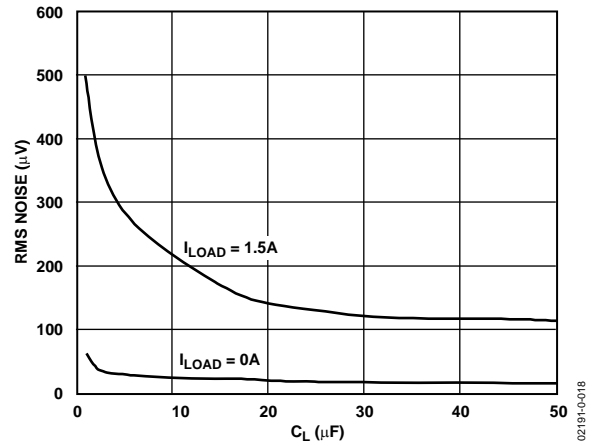

Figure 18. RMS Noise vs. C_L (10 Hz to 100 kHz)

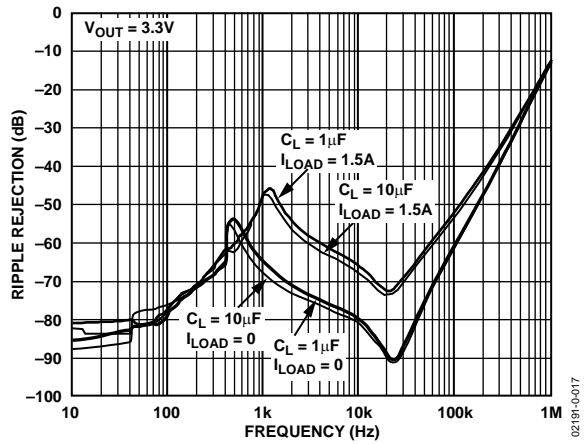

Figure 17. Power Supply Ripple Rejection

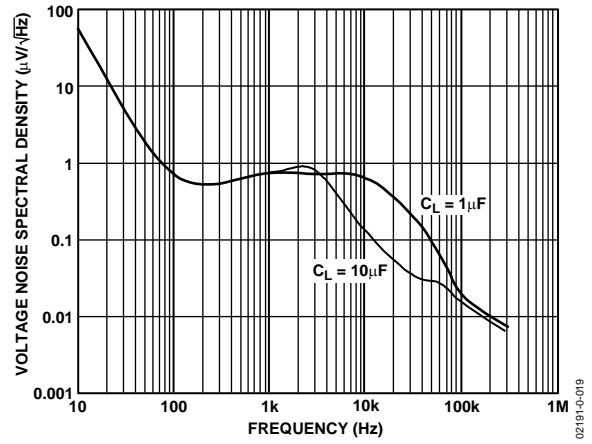

Figure 19. Output Noise Density

THEORY OF OPERATION

The ADP3339 anyCAP LDO uses a single control loop for regulation and reference functions. The output voltage is sensed by a resistive voltage divider, consisting of R1 and R2, which is varied to provide the available output voltage option. Feedback is taken from this network by way of a series diode (D1) and a second resistor divider (R3 and R4) to the input of an amplifier.

A very high gain error amplifier is used to control this loop. The amplifier is constructed in such a way that equilibrium produces a large, temperature-proportional input offset voltage that is repeatable and very well controlled. The temperature-proportional offset voltage is combined with the complementary diode voltage to form a virtual band gap voltage that is implicit in the network, although it never appears explicitly in the circuit. Ultimately, this patented design makes it possible to control the loop with only one amplifier. This technique also improves the noise characteristics of the amplifier by providing more flexibility on the trade-off of noise sources that leads to a low noise design.

The R1/R2 divider is chosen in the same ratio as the band gap voltage to the output voltage. Although the R1/R2 resistor divider is loaded by Diode D1 and a second divider consisting of R3 and R4, the values can be chosen to produce a temperature-stable output. This unique arrangement specifically corrects for the loading of the divider, thus avoiding the error resulting from base current loading in conventional circuits.

The patented amplifier controls a new and unique noninverting driver that drives the pass transistor, Q1. The use of this special noninverting driver enables the frequency compensation to include the load capacitor in a pole-splitting arrangement to achieve reduced sensitivity to the value, type, and ESR of the load capacitance.

Most LDOs place very strict requirements on the range of ESR values for the output capacitor because they are difficult to stabilize due to the uncertainty of load capacitance and resistance. Moreover, the ESR value required to keep conventional LDOs stable changes depending on load and temperature. These ESR limitations make designing with LDOs more difficult because of their unclear specifications and extreme variations over temperature.

With the ADP3339 anyCAP LDO, this is no longer true. The ADP3339 can be used with virtually any good quality capacitor, with no constraint on the minimum ESR. This innovative design allows the circuit to be stable with just a small 1 μ F capacitor on the output. Additional advantages of the pole-splitting scheme include superior line noise rejection and very high regulator gain, which lead to excellent line and load regulation. An impressive $\pm 1.5\%$ accuracy is guaranteed over line, load, and temperature.

Additional features of the circuit include current limit and thermal shutdown.

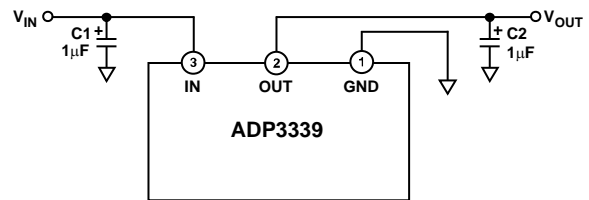

Figure 20. Typical Application Circuit

02191-0-021

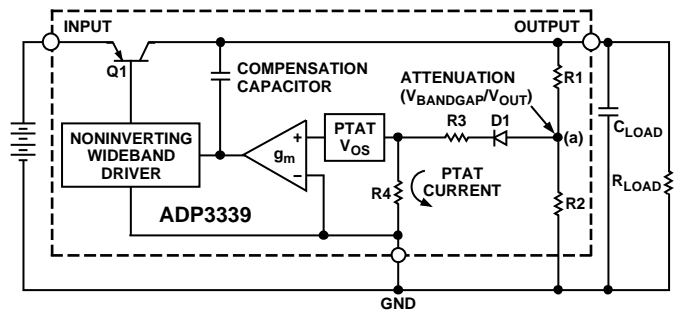

Figure 21. Functional Block Diagram

02191-0-020

APPLICATIONS INFORMATION

CAPACITOR SELECTION

Output Capacitor

The stability and transient response of the LDO is a function of the output capacitor. The ADP3339 is stable with a wide range of capacitor values, types, and ESR (anyCAP). A capacitor as low as 1 μF is all that is needed for stability. A higher capacitance may be necessary if high output current surges are anticipated, or if the output capacitor cannot be located near the output and ground pins. The ADP3339 is stable with extremely low ESR capacitors (ESR ≈ 0) such as multilayer ceramic capacitors (MLCC) or OSCON. Note that the effective capacitance of some capacitor types falls below the minimum over temperature or with dc voltage.

Input Capacitor

An input bypass capacitor is not strictly required but is recommended in any application involving long input wires or high source impedance. Connecting a 1 μF capacitor from the input to ground reduces the circuit's sensitivity to PC board layout and input transients. If a larger output capacitor is necessary, a larger value input capacitor is also recommended.

OUTPUT CURRENT LIMIT

The ADP3339 is short-circuit protected by limiting the pass transistor's base drive current. The maximum output current is limited to about 3 A. See Figure 16.

THERMAL OVERLOAD PROTECTION

The ADP3339 is protected against damage due to excessive power dissipation by its thermal overload protection circuit. Thermal protection limits the die temperature to a maximum of 160°C. Under extreme conditions (that is, high ambient temperature and power dissipation) where the die temperature starts to rise above 160°C, the output current is reduced until the die temperature has dropped to a safe level.

Current and thermal limit protections are intended to protect the device against accidental overload conditions. For normal operation, the device's power dissipation should be externally limited so that the junction temperature does not exceed 150°C.

CALCULATING POWER DISSIPATION

Device power dissipation is calculated as follows:

$$P_D = (V_{IN} - V_{OUT}) \times I_{LOAD} + (V_{IN} \times I_{GND})$$

where I_{LOAD} and I_{GND} are the load current and ground current, and V_{IN} and V_{OUT} are the input and output voltages, respectively.

Assuming worst-case operating conditions are $I_{LOAD} = 1.5 \text{ A}$, $I_{GND} = 14 \text{ mA}$, $V_{IN} = 3.3 \text{ V}$, and $V_{OUT} = 2.5 \text{ V}$, the device power dissipation is

$$P_D = (3.3 \text{ V} - 2.5 \text{ V}) \times 1500 \text{ mA} + (3.3 \text{ V} \times 14 \text{ mA}) = 1246 \text{ mW}$$

Therefore, for a junction temperature of 125°C and a maximum ambient temperature of 85°C, the required thermal resistance from junction to ambient is

$$\theta_{JA} = \frac{125^\circ\text{C} - 85^\circ\text{C}}{1.246 \text{ W}} = 32.1^\circ\text{C/W}$$

PRINTED CIRCUIT BOARD LAYOUT CONSIDERATIONS

The thermal resistance, θ_{JA} , of SOT-223 is determined by the sum of the junction-to-case and the case-to-ambient thermal resistances. The junction-to-case thermal resistance, θ_{JC} , is determined by the package design and specified at 26.8°C/W. However, the case-to-ambient thermal resistance is determined by the printed circuit board design.

As shown in Figure 22, the amount of copper onto which the ADP3339 is mounted affects thermal performance. When mounted onto the minimal pads of 2 oz. copper (see Figure 22a), θ_{JA} is 126.6°C/W. Adding a small copper pad under the ADP3339 (see Figure 22b) reduces the θ_{JA} to 102.9°C/W. Increasing the copper pad to 1 square inch (see Figure 22c) reduces the θ_{JA} even further, to 52.8°C/W.

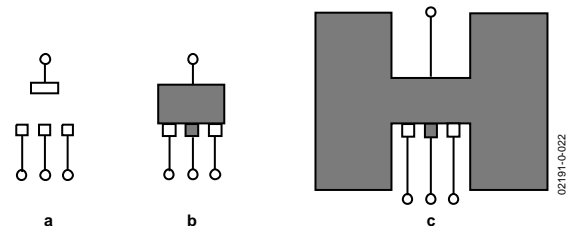
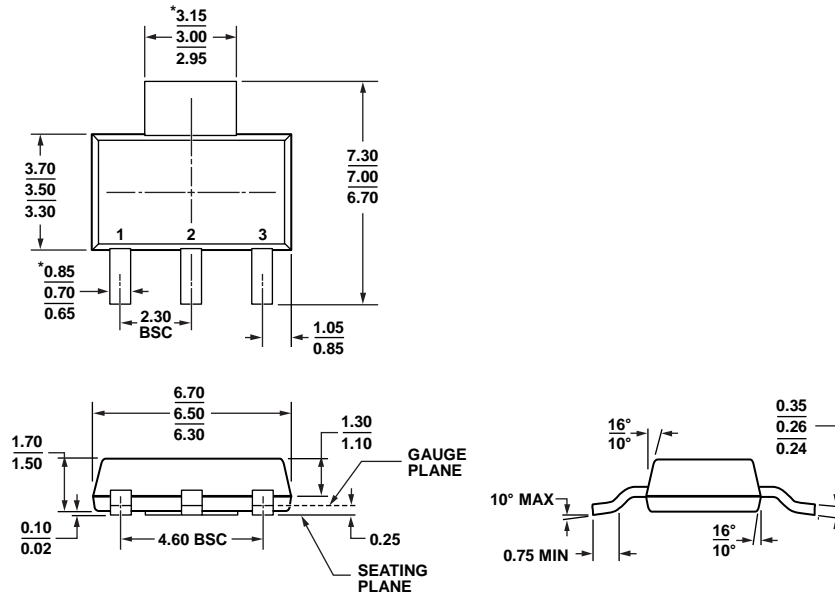

Figure 22. PCB Layouts

Use the following general guidelines when designing printed circuit boards:

1. Keep the output capacitor as close to the output and ground pins as possible.
2. Keep the input capacitor as close to the input and ground pins as possible.
3. PC board traces with larger cross sectional areas remove more heat from the ADP3339. For optimum heat transfer, use thick copper and use wide traces.
4. The thermal resistance can be decreased by adding a copper pad under the ADP3339, as shown in Figure 22b.
5. If possible, use the adjacent area to add more copper around the ADP3339. Connecting the copper area to the output of the ADP3339, as shown in Figure 22c, is best, but thermal performance is improved even if it is connected to other pins.
6. Use additional copper layers or planes to reduce the thermal resistance. Again, connecting the other layers to the output of the ADP3339 is best, but is not necessary. When connecting the output pad to other layers, use multiple vias.

OUTLINE DIMENSIONS



*COMPLIANT TO JEDEC STANDARDS TO-261-AA WITH THE EXCEPTION TO LEAD WIDTH.

Figure 23. 3-Lead Small Outline Transistor Package [SOT-223] (KC-3)
Dimensions shown in millimeters

103107-A

ORDERING GUIDE

Model ¹	Temperature Range	Output Voltage (V)	Package Description	Package Option ²	Branding
ADP3339AKC-1.5-RL	-40°C to +85°C	1.5	3-Lead SOT-223	KC-3	
ADP3339AKCZ-1.5-RL	-40°C to +85°C	1.5	3-Lead SOT-223	KC-3	L1C
ADP3339AKCZ-1.5-R7	-40°C to +85°C	1.5	3-Lead SOT-223	KC-3	L1C
ADP3339AKCZ-1.8-RL	-40°C to +85°C	1.8	3-Lead SOT-223	KC-3	L19
ADP3339AKCZ-1.8-R7	-40°C to +85°C	1.8	3-Lead SOT-223	KC-3	L19
ADP3339AKCZ-2.5-RL	-40°C to +85°C	2.5	3-Lead SOT-223	KC-3	L1D
ADP3339AKCZ-2.5-R7	-40°C to +85°C	2.5	3-Lead SOT-223	KC-3	L1D
ADP3339AKC-2.85-RL	-40°C to +85°C	2.85	3-Lead SOT-223	KC-3	
ADP3339AKCZ-3-R7	-40°C to +85°C	3.0	3-Lead SOT-223	KC-3	L3F
ADP3339AKC-3.3-RL	-40°C to +85°C	3.3	3-Lead SOT-223	KC-3	L1A
ADP3339AKCZ-3.3-RL	-40°C to +85°C	3.3	3-Lead SOT-223	KC-3	L1A
ADP3339AKCZ-3.3-R7	-40°C to +85°C	3.3	3-Lead SOT-223	KC-3	L1A
ADP3339AKCZ-5-R7	-40°C to +85°C	5	3-Lead SOT-223	KC-3	L3G

¹ Z = RoHS Compliant Part.

² This package option is halide free.

NOTES

Looking for pricing, stock, or lifecycle information?

Click below to explore more details on WIN SOURCE:

- ⊖ [View ADP3339AKCZ-3-RL7 on WIN SOURCE](#)
- ⊖ [Analog Devices Inc. Information](#)

Optimize Your Supply Chain with WIN SOURCE Solutions

- ✓ Global Sourcing Solution
- ✓ Obsolete Management
- ✓ Cost Control Management
- ✓ Shortage Management
- ✓ Alternative Solution
- ✓ Excess Inventory Management