



THE DATASHEET OF
3.0SMCJ14A-13



3.0SMCJ5.0A /14A /20A /22A /24A /28A /30A /58A

3000W SURFACE MOUNT TRANSIENT VOLTAGE SUPPRESSOR

Features

- 3000W Peak Pulse Power Dissipation
- Glass Passivated Die Construction
- Excellent Clamping Capability
- Fast Response Time
- **Lead-Free Finish; RoHS Compliant (Notes 1 & 2)**
- **Halogen and Antimony Free. "Green" Device (Note 3)**

Mechanical Data

- Case: SMC
- Case Material: Molded Plastic. UL Flammability Classification Rating 94V-0
- Moisture Sensitivity: Level 1 per J-STD-020
- Terminals: Solderable per MIL-STD-202, Method 208 (B3)
- Lead-Free Plating (Matte Tin Finish)
- Polarity Indicator: Cathode Band
- Weight: 0.21 grams (Approximate)

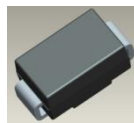

Top View

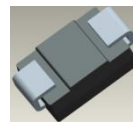

Bottom View

Ordering Information (Note 4)

Part Number	Case	Packaging
3.0SMCJ5.0A-13	SMC	3000/Tape & Reel
3.0SMCJ14A-13	SMC	3000/Tape & Reel
3.0SMCJ20A-13	SMC	3000/Tape & Reel
3.0SMCJ22A-13	SMC	3000/Tape & Reel
3.0SMCJ24A-13	SMC	3000/Tape & Reel
3.0SMCJ28A-13	SMC	3000/Tape & Reel
3.0SMCJ30A-13	SMC	3000/Tape & Reel
3.0SMCJ58A-13	SMC	3000/Tape & Reel

- Notes:
1. EU Directive 2002/95/EC (RoHS) & 2011/65/EU (RoHS 2) compliant. All applicable RoHS exemptions applied.
 2. See http://www.diodes.com/quality/lead_free.html for more information about Diodes Incorporated's definitions of Halogen- and Antimony-free, "Green" and Lead-free.
 3. Halogen- and Antimony-free "Green" products are defined as those which contain <900ppm bromine, <900ppm chlorine (<1500ppm total Br + Cl) and <1000ppm antimony compounds.
 4. For packaging details, go to our website at <http://www.diodes.com/products/packages.html>.

Marking Information



xxx = Product Type Marking Code,
See Electrical Characteristics Table
DII = Manufacturers' Code Marking
YWW = Date Code Marking
Y = Last Digit of Year (ex: 4 for 2014)
WW = Week Code (01 - 53)

Maximum Ratings (@T_A = +25°C, unless otherwise specified.)

Single phase, half wave, 60Hz, resistive or inductive load.
For capacitive load, derate current by 20%.

Characteristic	Symbol	Value	Unit
Peak Pulse Power Dissipation (Note 5)	PPK	3000	W
Peak Forward Surge Current, 8.3ms Single Half Sine Wave Superimposed on Rated Load (Notes 6 & 7)	I _{FSM}	300	A

Thermal Characteristics

Characteristic	Symbol	Value	Unit
Operating and Storage Temperature Range	T _J , T _{STG}	-55 to +175	°C

Electrical Characteristics (@T_A = +25°C unless otherwise specified.)

Part Number	Reverse Standoff Voltage	Breakdown Voltage V _{BR} @ I _T (Note 8)		Test Current	Max. Reverse Leakage @ V _{RWM}	Max Clamping Voltage @ I _{PP}	Max Peak Pulse Current I _{PP}	Typical Total Capacitance (Note 10)	Marking Code
		Min (V)	Max (V)						
See Notes 1 & 9	V _{RWM} (V)			I _T (mA)	I _R (μA)	V _C (V)	(A)	C _T (pF)	
3.0SMCJ5.0A	5.0	6.40	7.07	10	1000	9.2	326.1	8,000	HDE
3.0SMCJ14A	14.0	15.60	17.2	1.0	5.0	23.2	129.3	3,500	HEK
3.0SMCJ20A	20.0	22.20	24.5	1.0	5.0	32.4	92.6	3,300	HEV
3.0SMCJ22A	22.0	24.40	27.0	1.0	5.0	35.5	84.5	3,000	HEX
3.0SMCJ24A	24.0	26.70	29.5	1.0	5.0	38.9	77.1	3,000	HEZ
3.0SMCJ28A	28.0	31.10	34.4	1.0	5.0	45.4	66.1	1,800	HFG
3.0SMCJ30A	30.0	33.30	36.8	1.0	5.0	48.4	62.0	1,700	HFK
3.0SMCJ58A	58.0	64.40	71.2	1.0	5.0	93.6	32.1	1,500	HGG

- Notes:
- Non-repetitive current pulse, per Figure 4 and derated above T_A = +25°C per Figure 1.
 - Mounted on 8.00mm² (0.013mm thick) land areas.
 - Measured with 8.3ms single half sine-wave. Duty cycle = 4 pulses per minute maximum.
 - V_{BR} measured with I_T current pulse = 10 ~ 15 ms.
 - Additional voltages may be available upon request. Please contact the Diodes Incorporated sales department for assistance.
 - V_R = 0V, f = 1MHz

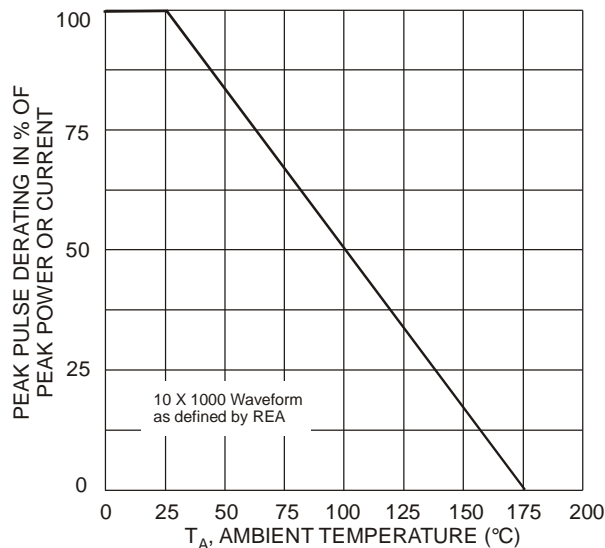

Fig. 1 Pulse Derating Curve

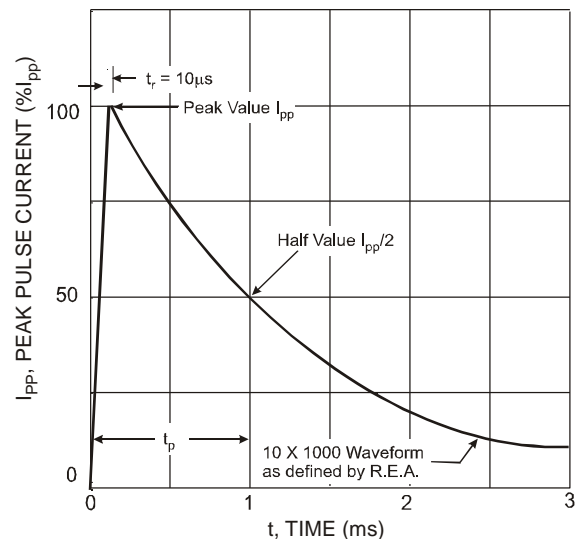
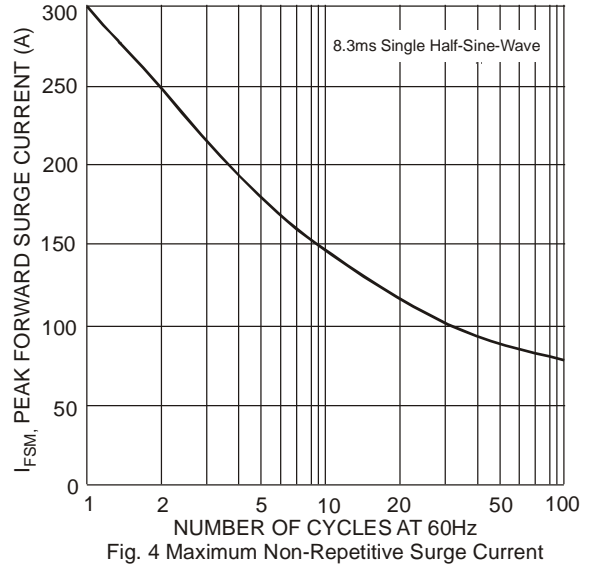
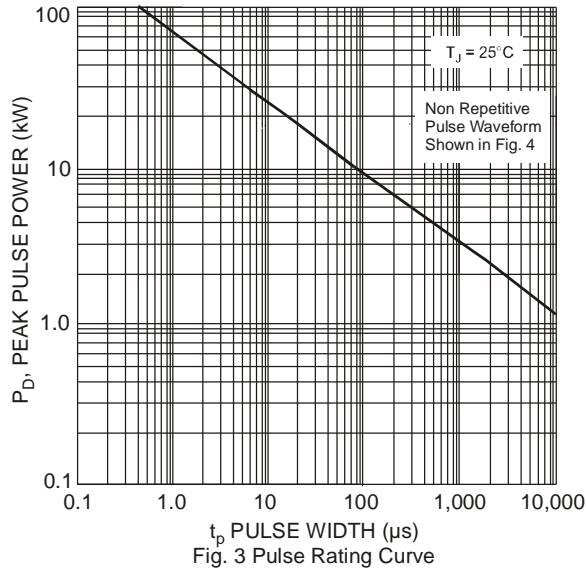
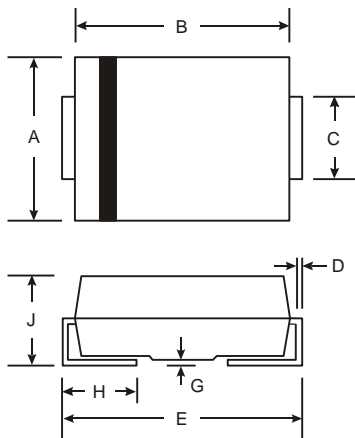

Fig. 2 Pulse Waveform



Package Outline Dimensions

Please see AP02002 at <http://www.diodes.com/datasheets/ap02002.pdf> for the latest version.



SMC		
Dim	Min	Max
A	5.59	6.22
B	6.60	7.11
C	2.75	3.18
D	0.15	0.31
E	7.75	8.13
G	0.10	0.20
H	0.76	1.52
J	2.00	2.50
All Dimensions in mm		

Suggested Pad Layout

Please see AP02001 at <http://www.diodes.com/datasheets/ap02001.pdf> for the latest version.

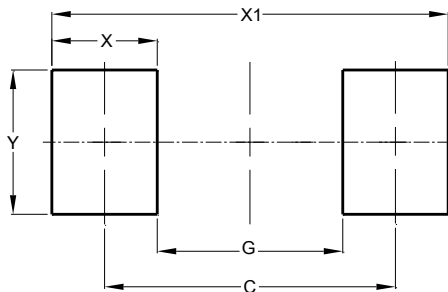

Dimensions	Value (in mm)
C	6.90
G	4.40
X	2.50
X1	9.40
Y	3.30

IMPORTANT NOTICE

DIODES INCORPORATED MAKES NO WARRANTY OF ANY KIND, EXPRESS OR IMPLIED, WITH REGARDS TO THIS DOCUMENT, INCLUDING, BUT NOT LIMITED TO, THE IMPLIED WARRANTIES OF MERCHANTABILITY AND FITNESS FOR A PARTICULAR PURPOSE (AND THEIR EQUIVALENTS UNDER THE LAWS OF ANY JURISDICTION).

Diodes Incorporated and its subsidiaries reserve the right to make modifications, enhancements, improvements, corrections or other changes without further notice to this document and any product described herein. Diodes Incorporated does not assume any liability arising out of the application or use of this document or any product described herein; neither does Diodes Incorporated convey any license under its patent or trademark rights, nor the rights of others. Any Customer or user of this document or products described herein in such applications shall assume all risks of such use and will agree to hold Diodes Incorporated and all the companies whose products are represented on Diodes Incorporated website, harmless against all damages.

Diodes Incorporated does not warrant or accept any liability whatsoever in respect of any products purchased through unauthorized sales channel. Should Customers purchase or use Diodes Incorporated products for any unintended or unauthorized application, Customers shall indemnify and hold Diodes Incorporated and its representatives harmless against all claims, damages, expenses, and attorney fees arising out of, directly or indirectly, any claim of personal injury or death associated with such unintended or unauthorized application.

Products described herein may be covered by one or more United States, international or foreign patents pending. Product names and markings noted herein may also be covered by one or more United States, international or foreign trademarks.

This document is written in English but may be translated into multiple languages for reference. Only the English version of this document is the final and determinative format released by Diodes Incorporated.

LIFE SUPPORT

Diodes Incorporated products are specifically not authorized for use as critical components in life support devices or systems without the express written approval of the Chief Executive Officer of Diodes Incorporated. As used herein:

A. Life support devices or systems are devices or systems which:

1. are intended to implant into the body, or
2. support or sustain life and whose failure to perform when properly used in accordance with instructions for use provided in the labeling can be reasonably expected to result in significant injury to the user.

B. A critical component is any component in a life support device or system whose failure to perform can be reasonably expected to cause the failure of the life support device or to affect its safety or effectiveness.

Customers represent that they have all necessary expertise in the safety and regulatory ramifications of their life support devices or systems, and acknowledge and agree that they are solely responsible for all legal, regulatory and safety-related requirements concerning their products and any use of Diodes Incorporated products in such safety-critical, life support devices or systems, notwithstanding any devices- or systems-related information or support that may be provided by Diodes Incorporated. Further, Customers must fully indemnify Diodes Incorporated and its representatives against any damages arising out of the use of Diodes Incorporated products in such safety-critical, life support devices or systems.

Copyright © 2014, Diodes Incorporated

www.diodes.com

Looking for pricing, stock, or lifecycle information?

Click below to explore more details on WIN SOURCE:

 [View 3.0SMCJ14A-13 on WIN SOURCE](#)

 [Diodes Incorporated](#) Information

Optimize Your Supply Chain with WIN SOURCE Solutions

-  Global Sourcing Solution
-  Obsolete Management
-  Cost Control Management
-  Shortage Management
-  Alternative Solution
-  Excess Inventory Management