



**THE DATASHEET OF  
P6SMB10AT3G**



# P6SMB6.8AT3G Series, SZP6SMB6.8AT3G Series

## 600 Watt Peak Power Zener Transient Voltage Suppressors

### Unidirectional\*

The SMB series is designed to protect voltage sensitive components from high voltage, high energy transients. They have excellent clamping capability, high surge capability, low zener impedance and fast response time. The SMB series is supplied in ON Semiconductor's exclusive, cost-effective, highly reliable SURMETIC® package and is ideally suited for use in communication systems, automotive, numerical controls, process controls, medical equipment, business machines, power supplies and many other industrial/consumer applications.

#### Specification Features:

- Working Peak Reverse Voltage Range – 5.8 to 171 V
- Standard Zener Breakdown Voltage Range – 6.8 to 200 V
- Peak Power – 600 W @ 1 ms
- ESD Rating of Class 3 (> 16 kV) per Human Body Model
- Maximum Clamp Voltage @ Peak Pulse Current
- Low Leakage < 5  $\mu$ A Above 10 V
- UL 497B for Isolated Loop Circuit Protection
- Response Time is Typically < 1 ns
- SZ Prefix for Automotive and Other Applications Requiring Unique Site and Control Change Requirements; AEC-Q101 Qualified and PPAP Capable
- These Devices are Pb-Free and are RoHS Compliant\*

#### Mechanical Characteristics:

**CASE:** Void-free, transfer-molded, thermosetting plastic

**FINISH:** All external surfaces are corrosion resistant and leads are readily solderable

**MAXIMUM CASE TEMPERATURE FOR SOLDERING PURPOSES:**  
260°C for 10 Seconds

**LEADS:** Modified L-Bend providing more contact area to bond pads

**POLARITY:** Cathode indicated by polarity band

**MOUNTING POSITION:** Any

\*Please see P6SMB11CAT3 to P6SMB91CAT3 for Bidirectional devices.

\*For additional information on our Pb-Free strategy and soldering details, please download the ON Semiconductor Soldering and Mounting Techniques Reference Manual, SOLDERRM/D.



ON Semiconductor®

[www.onsemi.com](http://www.onsemi.com)

**PLASTIC SURFACE MOUNT  
ZENER OVERVOLTAGE  
TRANSIENT SUPPRESSORS  
5.8–171 VOLTS  
600 WATT PEAK POWER**



**SMB  
CASE 403A  
PLASTIC**

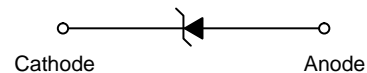

#### MARKING DIAGRAM

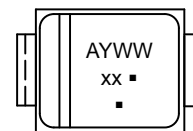

- A = Assembly Location
- Y = Year
- WW = Work Week
- xx = Device Code (Refer to page 3)
- = Pb-Free Package

(Note: Microdot may be in either location)

#### ORDERING INFORMATION

| Device         | Package          | Shipping†              |
|----------------|------------------|------------------------|
| P6SMBxxxAT3G   | SMB<br>(Pb-Free) | 2,500 /<br>Tape & Reel |
| SZP6SMBxxxAT3G | SMB<br>(Pb-Free) | 2,500 /<br>Tape & Reel |

†For information on tape and reel specifications, including part orientation and tape sizes, please refer to our Tape and Reel Packaging Specifications Brochure, BRD8011/D.

## P6SMB6.8AT3G Series, SZP6SMB6.8AT3G Series

### MAXIMUM RATINGS

| Rating  | Symbol          | Value       | Unit                      |
|---|-----------------|-------------|---------------------------|
| Peak Power Dissipation (Note 1) @ $T_L = 25^\circ\text{C}$ , Pulse Width = 1 ms                                       | $P_{PK}$        | 600         | W                         |
| DC Power Dissipation @ $T_L = 75^\circ\text{C}$ Measured Zero Lead Length (Note 2)<br>Derate Above $75^\circ\text{C}$ | $P_D$           | 3.0<br>40   | W<br>mW/ $^\circ\text{C}$ |
| Thermal Resistance from Junction-to-Lead  | $R_{\theta JL}$ | 25          | $^\circ\text{C}/\text{W}$ |
| DC Power Dissipation (Note 3) @ $T_A = 25^\circ\text{C}$<br>Derate Above $25^\circ\text{C}$                           | $P_D$           | 0.55<br>4.4 | W<br>mW/ $^\circ\text{C}$ |
| Thermal Resistance from Junction-to-Ambient   | $R_{\theta JA}$ | 226         | $^\circ\text{C}/\text{W}$ |
| Forward Surge Current (Note 4) @ $T_A = 25^\circ\text{C}$   | $I_{FSM}$       | 100         | A                         |
| Operating and Storage Temperature Range   | $T_J, T_{stg}$  | -65 to +150 | $^\circ\text{C}$          |

Stresses exceeding those listed in the Maximum Ratings table may damage the device. If any of these limits are exceeded, device functionality should not be assumed, damage may occur and reliability may be affected.

1. 10 X 1000  $\mu\text{s}$ , non-repetitive
2. 1" square copper pad, FR-4 board
3. FR-4 board, using ON Semiconductor minimum recommended footprint, as shown in 403A case outline dimensions spec.
4. 1/2 sine wave (or equivalent square wave), PW = 8.3 ms, duty cycle = 4 pulses per minute maximum.

### ELECTRICAL CHARACTERISTICS

( $T_A = 25^\circ\text{C}$  unless otherwise noted,  $V_F = 3.5\text{ V Max.}$  @  $I_F$   
(Note 4) = 30 A,  $V_F = 1.3\text{ V Max.}$  @  $I_F$  (Note 4) = 3 A) (Note 5)

| Symbol          | Parameter                                   |
|-----------------|---|
| $I_{PP}$        | Maximum Reverse Peak Pulse Current          |
| $V_C$           | Clamping Voltage @ $I_{PP}$                 |
| $V_{RWM}$       | Working Peak Reverse Voltage                |
| $I_R$           | Maximum Reverse Leakage Current @ $V_{RWM}$ |
| $V_{BR}$        | Breakdown Voltage @ $I_T$                   |
| $I_T$           | Test Current                                |
| $\Theta V_{BR}$ | Maximum Temperature Coefficient of $V_{BR}$ |
| $I_F$           | Forward Current                             |
| $V_F$           | Forward Voltage @ $I_F$                     |

5. 1/2 sine wave or equivalent, PW = 8.3 ms, non-repetitive duty cycle

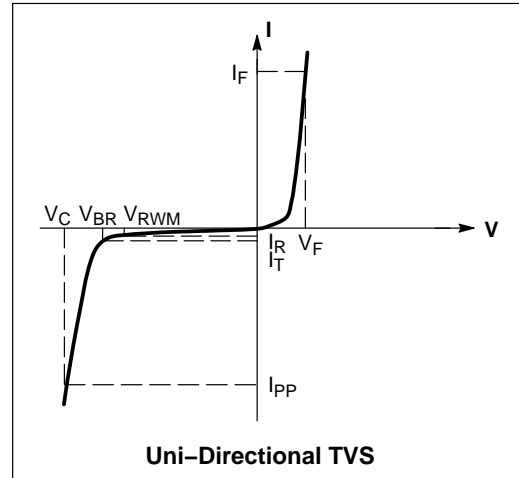

## P6SMB6.8AT3G Series, SZP6SMB6.8AT3G Series

### ELECTRICAL CHARACTERISTICS

| Device*      | Device Marking | V <sub>RWM</sub><br>(Note 6)<br>V | I <sub>R</sub> @<br>V <sub>RWM</sub><br>μA | Breakdown Voltage          |       |      |                  | V <sub>C</sub> @ I <sub>PP</sub> (Note 8) |                 | θV <sub>BR</sub><br>%/°C | C <sub>typ</sub><br>(Note 9)<br>pF |
|--------------|----------------|-----------------------------------|--|----------------------------|-------|------|------------------|---|-----------------|--------------------------|------------------------------------|
|              |                |                                   |  | V <sub>BR</sub> V (Note 7) |       |      | @ I <sub>T</sub> | V <sub>C</sub>                            | I <sub>PP</sub> |                          |                                    |
|              |                |                                   |  | Min                        | Nom   | Max  | mA               | V   | A               |                          |                                    |
| P6SMB6.8AT3G | 6V8A           | 5.8                               | 1000                                       | 6.45                       | 6.8   | 7.14 | 10               | 10.5                                      | 57              | 0.057                    | 2380                               |
| P6SMB7.5AT3G | 7V5A           | 6.4                               | 500  | 7.13                       | 7.51  | 7.88 | 10               | 11.3                                      | 53              | 0.061                    | 2180                               |
| P6SMB8.2AT3G | 8V2A           | 7.02                              | 200  | 7.79                       | 8.2   | 8.61 | 10               | 12.1                                      | 50              | 0.065                    | 2015                               |
| P6SMB9.1AT3G | 9V1A           | 7.78                              | 50   | 8.65                       | 9.1   | 9.55 | 1                | 13.4                                      | 45              | 0.068                    | 1835                               |
| P6SMB10AT3G  | 10A            | 8.55                              | 10   | 9.5                        | 10    | 10.5 | 1                | 14.5                                      | 41              | 0.073                    | 1690                               |
| P6SMB12AT3G  | 12A            | 10.2                              | 5  | 11.4                       | 12    | 12.6 | 1                | 16.7                                      | 36              | 0.078                    | 1435                               |
| P6SMB13AT3G  | 13A            | 11.1                              | 5  | 12.4                       | 13.05 | 13.7 | 1                | 18.2                                      | 33              | 0.081                    | 1335                               |
| P6SMB15AT3G  | 15A            | 12.8                              | 5  | 14.3                       | 15.05 | 15.8 | 1                | 21.2                                      | 28              | 0.084                    | 1175                               |
| P6SMB16AT3G  | 16A            | 13.6                              | 5  | 15.2                       | 16    | 16.8 | 1                | 22.5                                      | 27              | 0.086                    | 1110                               |
| P6SMB18AT3G  | 18A            | 15.3                              | 5  | 17.1                       | 18    | 18.9 | 1                | 25.2                                      | 24              | 0.088                    | 1000                               |
| P6SMB20AT3G  | 20A            | 17.1                              | 5  | 19                         | 20    | 21   | 1                | 27.7                                      | 22              | 0.09                     | 910                                |
| P6SMB22AT3G  | 22A            | 18.8                              | 5  | 20.9                       | 22    | 23.1 | 1                | 30.6                                      | 20              | 0.092                    | 835                                |
| P6SMB24AT3G  | 24A            | 20.5                              | 5  | 22.8                       | 24    | 25.2 | 1                | 33.2                                      | 18              | 0.094                    | 775                                |
| P6SMB27AT3G  | 27A            | 23.1                              | 5  | 25.7                       | 27.05 | 28.4 | 1                | 37.5                                      | 16              | 0.096                    | 700                                |
| P6SMB30AT3G  | 30A            | 25.6                              | 5  | 28.5                       | 30    | 31.5 | 1                | 41.4                                      | 14.4            | 0.097                    | 635                                |
| P6SMB33AT3G  | 33A            | 28.2                              | 5  | 31.4                       | 33.05 | 34.7 | 1                | 45.7                                      | 13.2            | 0.098                    | 585                                |
| P6SMB36AT3G  | 36A            | 30.8                              | 5  | 34.2                       | 36    | 37.8 | 1                | 49.9                                      | 12              | 0.099                    | 540                                |
| P6SMB39AT3G  | 39A            | 33.3                              | 5  | 37.1                       | 39.05 | 41   | 1                | 53.9                                      | 11.2            | 0.1                      | 500                                |
| P6SMB43AT3G  | 43A            | 36.8                              | 5  | 40.9                       | 43.05 | 45.2 | 1                | 59.3                                      | 10.1            | 0.101                    | 460                                |
| P6SMB47AT3G  | 47A            | 40.2                              | 5  | 44.7                       | 47.05 | 49.4 | 1                | 64.8                                      | 9.3             | 0.101                    | 425                                |
| P6SMB51AT3G  | 51A            | 43.6                              | 5  | 48.5                       | 51.05 | 53.6 | 1                | 70.1                                      | 8.6             | 0.102                    | 395                                |
| P6SMB56AT3G  | 56A            | 47.8                              | 5  | 53.2                       | 56    | 58.8 | 1                | 77  | 7.8             | 0.103                    | 365                                |
| P6SMB62AT3G  | 62A            | 53                                | 5  | 58.9                       | 62    | 65.1 | 1                | 85  | 7.1             | 0.104                    | 335                                |
| P6SMB68AT3G  | 68A            | 58.1                              | 5  | 64.6                       | 68    | 71.4 | 1                | 92  | 6.5             | 0.104                    | 305                                |
| P6SMB75AT3G  | 75A            | 64.1                              | 5  | 71.3                       | 75.05 | 78.8 | 1                | 103                                       | 5.8             | 0.105                    | 280                                |
| P6SMB91AT3G  | 91A            | 77.8                              | 5  | 86.5                       | 91    | 95.5 | 1                | 125                                       | 4.8             | 0.106                    | 235                                |
| P6SMB100AT3G | 100A           | 85.5                              | 5  | 95                         | 100   | 105  | 1                | 137                                       | 4.4             | 0.106                    | 215                                |
| P6SMB120AT3G | 120A           | 102                               | 5  | 114                        | 120   | 126  | 1                | 165                                       | 3.6             | 0.107                    | 185                                |
| P6SMB130AT3G | 130A           | 111                               | 5  | 124                        | 130.5 | 137  | 1                | 179                                       | 3.3             | 0.107                    | 170                                |
| P6SMB150AT3G | 150A           | 128                               | 5  | 143                        | 150.5 | 158  | 1                | 207                                       | 2.9             | 0.108                    | 150                                |
| P6SMB160AT3G | 160A           | 136                               | 5  | 152                        | 160   | 168  | 1                | 219                                       | 2.7             | 0.108                    | 140                                |
| P6SMB180AT3G | 180A           | 154                               | 5  | 171                        | 180   | 189  | 1                | 246                                       | 2.4             | 0.108                    | 130                                |
| P6SMB200AT3G | 200A           | 171                               | 5  | 190                        | 200   | 210  | 1                | 274                                       | 2.2             | 0.108                    | 115                                |

6. A transient suppressor is normally selected according to the working peak reverse voltage (V<sub>RWM</sub>), which should be equal to or greater than the DC or continuous peak operating voltage level.

7. V<sub>BR</sub> measured at pulse test current I<sub>T</sub> at an ambient temperature of 25°C.

8. Surge current waveform per Figure 2 and derate per Figure 3.

9. Bias Voltage = 0 V, F = 1 MHz, T<sub>J</sub> = 25°C

\* Include SZ-prefix devices where applicable.

# P6SMB6.8AT3G Series, SZP6SMB6.8AT3G Series



Figure 1. Pulse Rating Curve

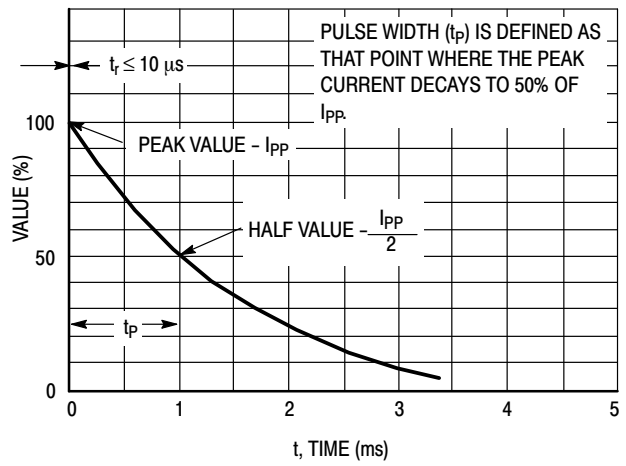

Figure 2. Pulse Waveform



Figure 3. Pulse Derating Curve



Figure 4. Typical Junction Capacitance vs. Bias Voltage

## TYPICAL PROTECTION CIRCUIT



APPLICATION NOTES

Response Time

In most applications, the transient suppressor device is placed in parallel with the equipment or component to be protected. In this situation, there is a time delay associated with the capacitance of the device and an overshoot condition associated with the inductance of the device and the inductance of the connection method. The capacitive effect is of minor importance in the parallel protection scheme because it only produces a time delay in the transition from the operating voltage to the clamp voltage as shown in Figure 5.

The inductive effects in the device are due to actual turn-on time (time required for the device to go from zero current to full current) and lead inductance. This inductive effect produces an overshoot in the voltage across the equipment or component being protected as shown in Figure 6. Minimizing this overshoot is very important in the application, since the main purpose for adding a transient suppressor is to clamp voltage spikes. The SMB series have a very good response time, typically < 1 ns and negligible inductance. However, external inductive effects could produce unacceptable overshoot. Proper circuit layout,

minimum lead lengths and placing the suppressor device as close as possible to the equipment or components to be protected will minimize this overshoot.

Some input impedance represented by  $Z_{in}$  is essential to prevent overstress of the protection device. This impedance should be as high as possible, without restricting the circuit operation.

Duty Cycle Derating

The data of Figure 1 applies for non-repetitive conditions and at a lead temperature of 25°C. If the duty cycle increases, the peak power must be reduced as indicated by the curves of Figure 7. Average power must be derated as the lead or ambient temperature rises above 25°C. The average power derating curve normally given on data sheets may be normalized and used for this purpose.

At first glance the derating curves of Figure 7 appear to be in error as the 10 ms pulse has a higher derating factor than the 10 μs pulse. However, when the derating factor for a given pulse of Figure 7 is multiplied by the peak power value of Figure 1 for the same pulse, the results follow the expected trend.

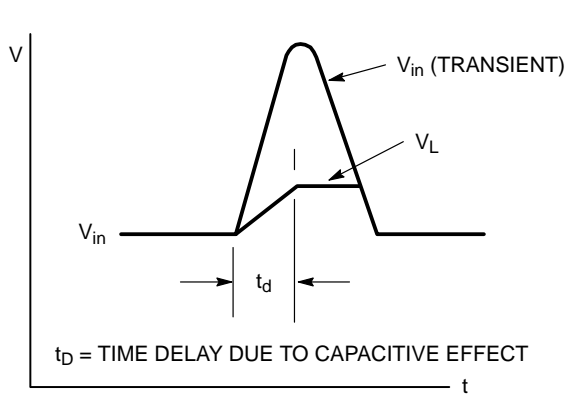

Figure 5.

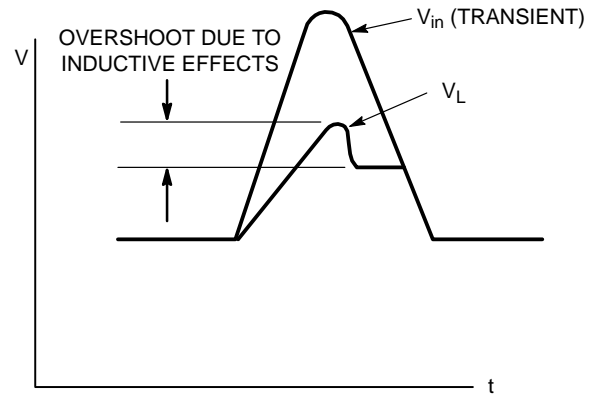

Figure 6.

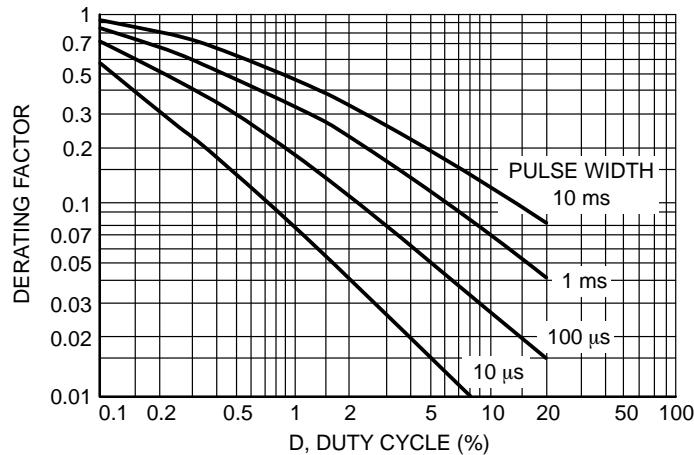

Figure 7. Typical Derating Factor for Duty Cycle

## P6SMB6.8AT3G Series, SZP6SMB6.8AT3G Series

### UL RECOGNITION

The entire series has *Underwriters Laboratory Recognition* for the classification of protectors (QVGQ2) under the UL standard for safety 497B and File #E210057. Many competitors only have one or two devices recognized or have recognition in a non-protective category. Some competitors have no recognition at all. With the UL497B recognition, our parts successfully passed several tests

including Strike Voltage Breakdown test, Endurance Conditioning, Temperature test, Dielectric Voltage-Withstand test, Discharge test and several more.

Whereas, some competitors have only passed a flammability test for the package material, we have been recognized for much more to be included in their Protector category.

# P6SMB6.8AT3G Series, SZP6SMB6.8AT3G Series

## PACKAGE DIMENSIONS

### SMB CASE 403A-03 ISSUE J

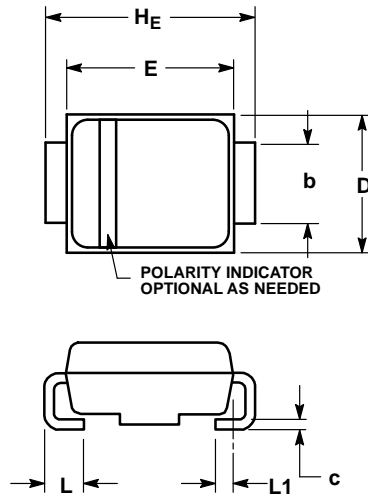

- NOTES:
1. DIMENSIONING AND TOLERANCING PER ANSI Y14.5M, 1982.
  2. CONTROLLING DIMENSION: INCH.
  3. DIMENSION b SHALL BE MEASURED WITHIN DIMENSION L1.

| DIM | MILLIMETERS |      |      | INCHES    |       |       |
|-----|-------------|------|------|-----------|-------|-------|
|     | MIN         | NOM  | MAX  | MIN       | NOM   | MAX   |
| A   | 1.95        | 2.30 | 2.47 | 0.077     | 0.091 | 0.097 |
| A1  | 0.05        | 0.10 | 0.20 | 0.002     | 0.004 | 0.008 |
| b   | 1.96        | 2.03 | 2.20 | 0.077     | 0.080 | 0.087 |
| c   | 0.15        | 0.23 | 0.31 | 0.006     | 0.009 | 0.012 |
| D   | 3.30        | 3.56 | 3.95 | 0.130     | 0.140 | 0.156 |
| E   | 4.06        | 4.32 | 4.60 | 0.160     | 0.170 | 0.181 |
| HE  | 5.21        | 5.44 | 5.60 | 0.205     | 0.214 | 0.220 |
| L   | 0.76        | 1.02 | 1.60 | 0.030     | 0.040 | 0.063 |
| L1  | 0.51 REF    |      |      | 0.020 REF |       |       |

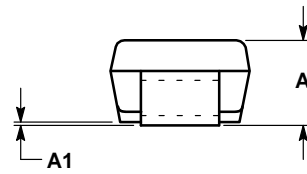

### SOLDERING FOOTPRINT\*

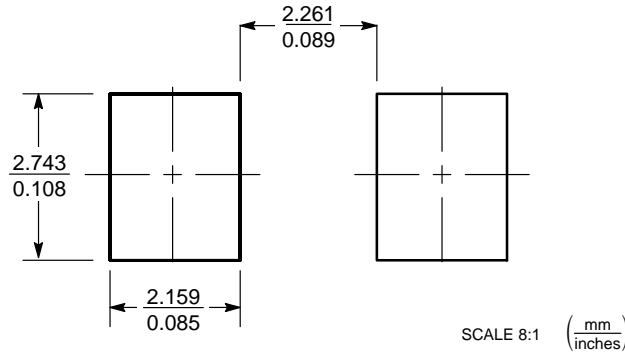

\*For additional information on our Pb-Free strategy and soldering details, please download the ON Semiconductor Soldering and Mounting Techniques Reference Manual, SOLDERRM/D.

SURMETIC is a registered trademark of Semiconductor Components Industries, LLC.

ON Semiconductor and are registered trademarks of Semiconductor Components Industries, LLC (SCILLC). SCILLC reserves the right to make changes without further notice to any products herein. SCILLC makes no warranty, representation or guarantee regarding the suitability of its products for any particular purpose, nor does SCILLC assume any liability arising out of the application or use of any product or circuit, and specifically disclaims any and all liability, including without limitation special, consequential or incidental damages. "Typical" parameters which may be provided in SCILLC data sheets and/or specifications can and do vary in different applications and actual performance may vary over time. All operating parameters, including "Typicals" must be validated for each customer application by customer's technical experts. SCILLC does not convey any license under its patent rights nor the rights of others. SCILLC products are not designed, intended, or authorized for use as components in systems intended for surgical implant into the body, or other applications intended to support or sustain life, or for any other application in which the failure of the SCILLC product could create a situation where personal injury or death may occur. Should Buyer purchase or use SCILLC products for any such unintended or unauthorized application, Buyer shall indemnify and hold SCILLC and its officers, employees, subsidiaries, affiliates, and distributors harmless against all claims, costs, damages, and expenses, and reasonable attorney fees arising out of, directly or indirectly, any claim of personal injury or death associated with such unintended or unauthorized use, even if such claim alleges that SCILLC was negligent regarding the design or manufacture of the part. SCILLC is an Equal Opportunity/Affirmative Action Employer. This literature is subject to all applicable copyright laws and is not for resale in any manner.

### PUBLICATION ORDERING INFORMATION



**LITERATURE FULFILLMENT:**  
Literature Distribution Center for ON Semiconductor  
P.O. Box 5163, Denver, Colorado 80217 USA  
**Phone:** 303-675-2175 or 800-344-3860 Toll Free USA/Canada  
**Fax:** 303-675-2176 or 800-344-3867 Toll Free USA/Canada  
**Email:** orderlit@onsemi.com

**N. American Technical Support:** 800-282-9855 Toll Free  
USA/Canada  
**Europe, Middle East and Africa Technical Support:**  
Phone: 421 33 790 2910  
**Japan Customer Focus Center**  
Phone: 81-3-5817-1050

**ON Semiconductor Website:** [www.onsemi.com](http://www.onsemi.com)  
**Order Literature:** <http://www.onsemi.com/orderlit>  
For additional information, please contact your local Sales Representative

## Looking for pricing, stock, or lifecycle information?

Click below to explore more details on WIN SOURCE:

-  [View P6SMB10AT3G on WIN SOURCE](#)
-  [Littelfuse Inc. Information](#)

## Optimize Your Supply Chain with WIN SOURCE Solutions

-  Global Sourcing Solution
-  Obsolete Management
-  Cost Control Management
-  Shortage Management
-  Alternative Solution
-  Excess Inventory Management