



**THE DATASHEET OF
ESD5V3U4RRSE6327HTSA1**



Ultra-Low Capacitance ESD Diode Array

- Rail-to-rail diodes with internal TVS diode
- ESD / transient protection of four I/O lines and one Vcc line exceeding:
 - IEC61000-4-2 (ESD): ± 15 kV (contact)
 - IEC61000-4-4 (EFT): 2.5 kV / 50 A (5/50 ns)
 - IEC61000-4-5 (surge): 3 A (8/20 μ s)
- Reverse working voltage data lines: 5.3 V max.
- Reverse working voltage Vcc: 6 V max.
- Very low capacitance: 0.4 pF typ.
- Very low reverse current < 10 nA typ.
- Very low clamping voltage:
 - 12 V typ. at positive transients
 - 4 V typ. at negative transients
- Pb-free (RoHS compliant) package

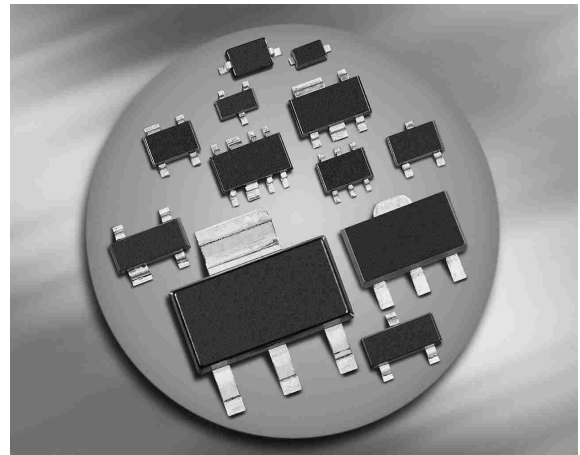

Applications

- USB 2.0 ports and future USB 3.0 ports
- Ethernet port: 10/100/1000 Mb/s
- IEEE 1394 FireWire ports
- Mobile communications e.g. high-speed SIM card protection
- Consumer products (STB, DVD, DSC, DVC...)
- Notebooks and desktop computers, peripherals



ESD5V3U4RRS

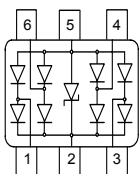

Type	Package	Configuration	Marking
ESD5V3U4RRS	SOT363	6 pins, uni-directional	E8s

Maximum Ratings at $T_A = 25^\circ\text{C}$, unless otherwise specified

Parameter	Symbol	Value	Unit
ESD contact discharge ¹⁾	V_{ESD}	15	kV
Peak pulse current ($t_p = 8 / 20 \mu\text{s}$) ²⁾	I_{pp}	3	A
Peak pulse power ($t_p = 8 / 20 \mu\text{s}$) ²⁾	P_{pk}	50	W
Operating temperature range	T_{op}	-55...125	°C
Storage temperature	T_{stg}	-65...150	

Electrical Characteristics at $T_A = 25^\circ\text{C}$, unless otherwise specified

Parameter	Symbol	Values			Unit
		min.	typ.	max.	

Characteristics ³⁾

Reverse working voltage I/O pin ⁴⁾ to pin 5 pin 2 to pin 5	V_{RWM}	-	-	5.3 6	V
Breakdown voltage $I_{\text{(BR)}} = 1 \text{ mA}$, any pin to pin 5	$V_{\text{(BR)}}$	6.3	-	-	
Reverse current $V_{\text{R}} = 5.3 \text{ V}$, any pin to pin 5	I_{R}	-	< 10	100	nA
Clamping voltage $I_{\text{PP}} = 1 \text{ A}$, $t_p = 8/20 \mu\text{s}$ ²⁾ , any pin to pin 5 $I_{\text{PP}} = 3 \text{ A}$, $t_p = 8/20 \mu\text{s}$ ²⁾ , any pin to pin 5	V_{CL}	-	10 12	13 15	V
Forward clamping voltage $I_{\text{PP}} = 1 \text{ A}$, $t_p = 8/20 \mu\text{s}$ ²⁾ , any pin to pin 5 $I_{\text{PP}} = 3 \text{ A}$, $t_p = 8/20 \mu\text{s}$ ²⁾ , any pin to pin 5	V_{FC}	-	2 4	4 6	
Line capacitance ⁵⁾⁴⁾ $V_{\text{R}} = 0 \text{ V}$, $f = 1 \text{ MHz}$, any I/O pin to pin 5	C_{T}	-	0.4	0.6	pF
Dynamic resistance ⁶⁾	R_{D}	-	-	-	-

¹⁾ V_{ESD} according to IEC61000-4-2

²⁾ I_{pp} according to IEC61000-4-5

³⁾ It is strongly recommended that pin 5 is connected to ground for proper functionality.

⁴⁾ I/O pins are pin 1, 3, 4, 6

⁵⁾ Total capacitance line to ground

⁶⁾ according to TLP tests

Power derating curve $P_{pk} = f(T_A)$

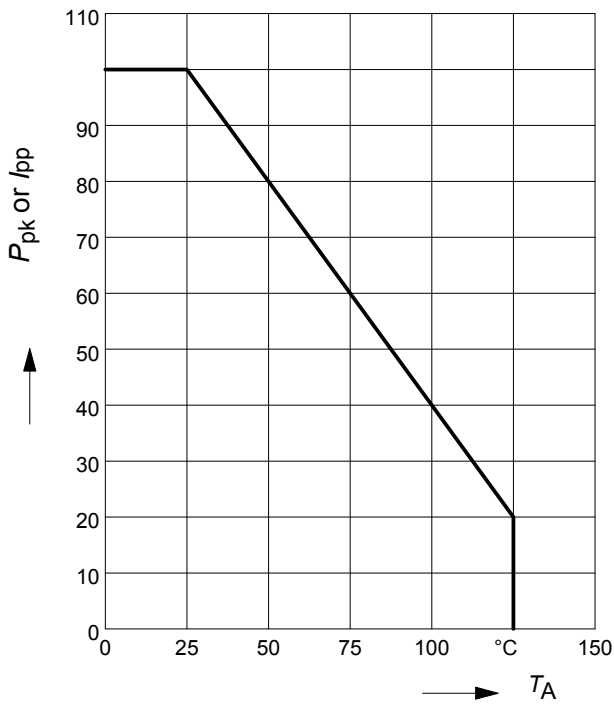

Clamping voltage, $V_{cl} = f(I_{pp})$

$t_p = 8 / 20 \mu s$

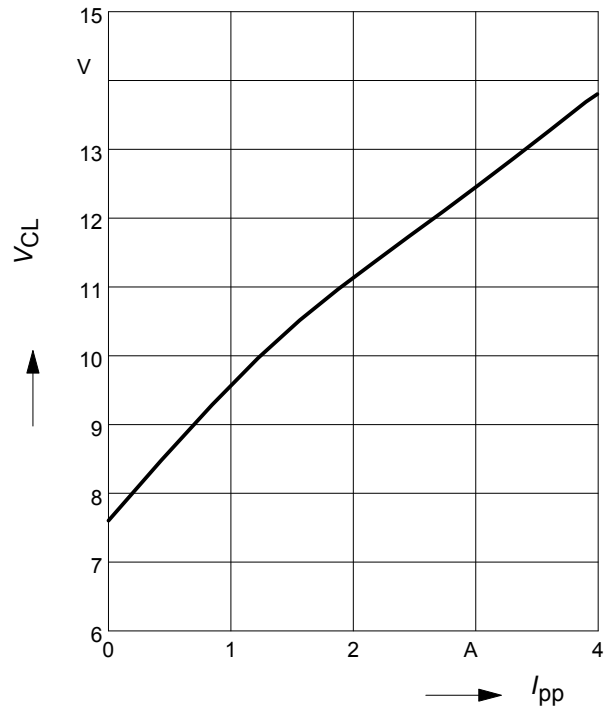

Forward clamping voltage $V_{FC} = f(I_{PP})$

$t_p = 8 / 20 \mu s$

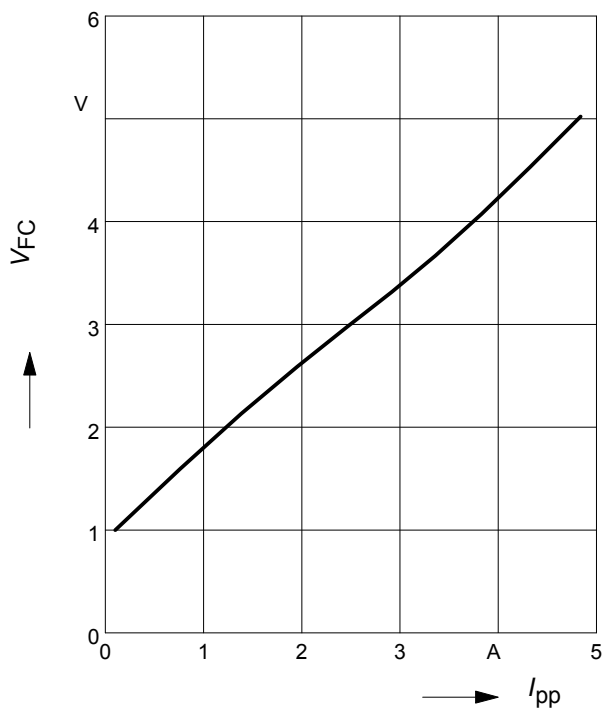

Reverse current $I_R = f(V_R)$

$T_A = \text{Parameter}$

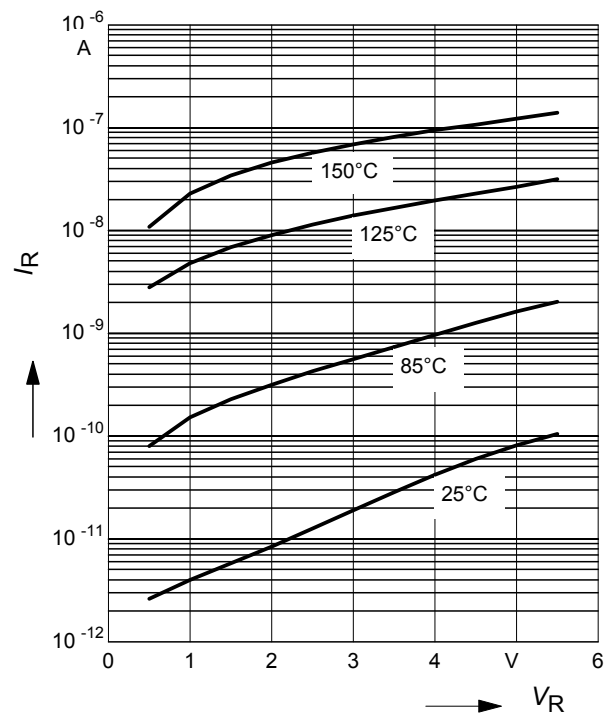

Diode capacitance $C_T = f(V_R)$

$f = 1\text{MHz}$

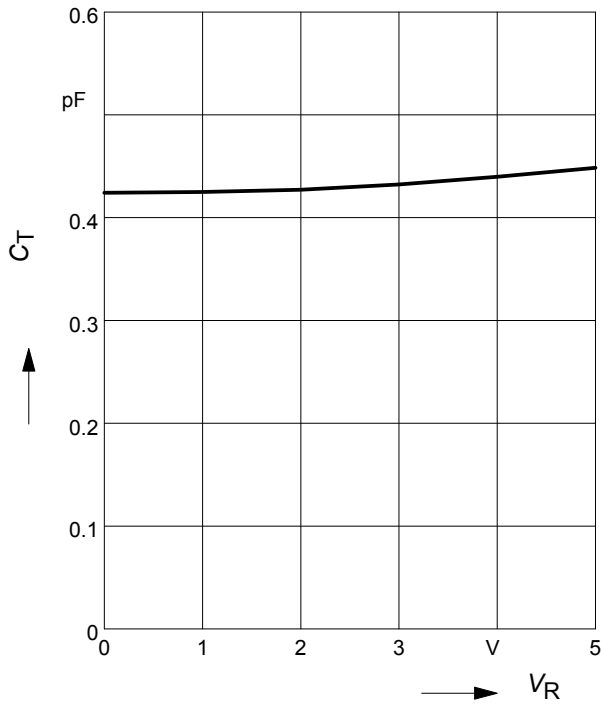

Application example ESD5V3U4RRS

4 data lines, uni-directional

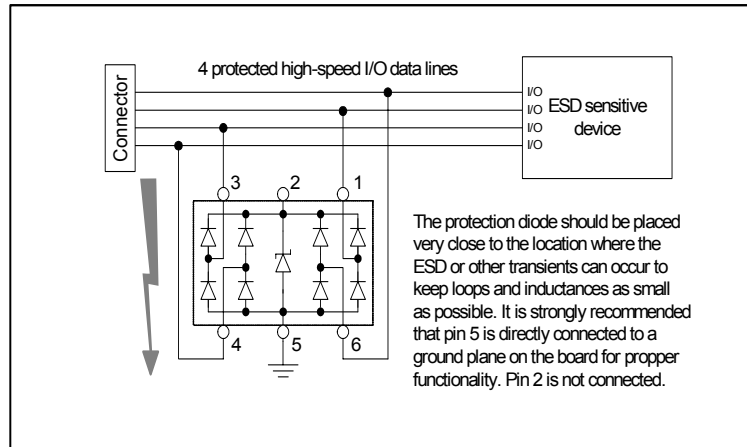

Application example ESD5V3U4RRS

4 data lines and 1 power supply line, uni-directional

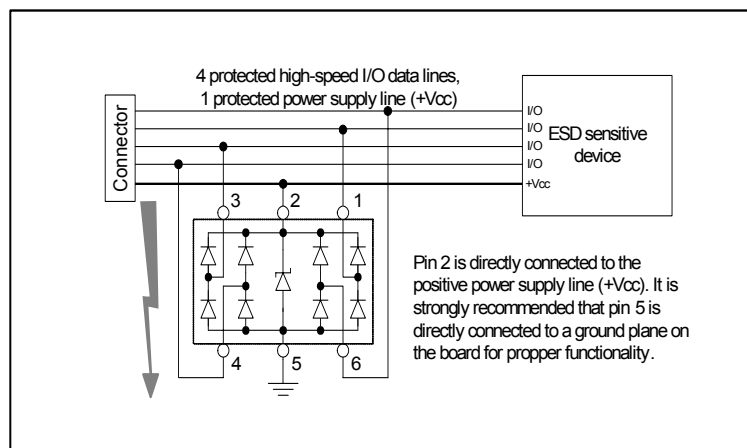

Package Outline

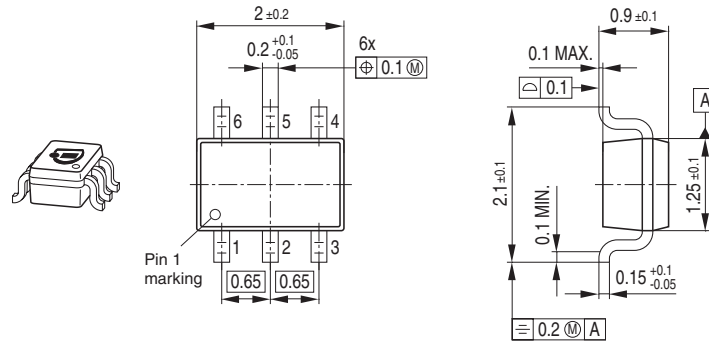

Foot Print

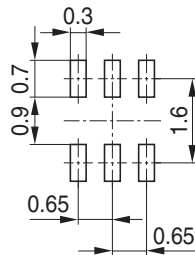

Marking Layout (Example)

Small variations in positioning of Date code, Type code and Manufacture are possible.

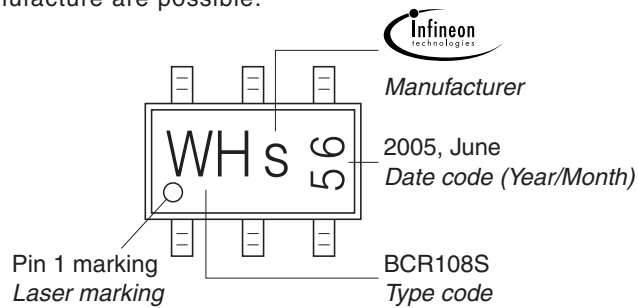

Standard Packing

Reel ø180 mm = 3.000 Pieces/Reel
 Reel ø330 mm = 10.000 Pieces/Reel

For symmetric types no defined Pin 1 orientation in reel.

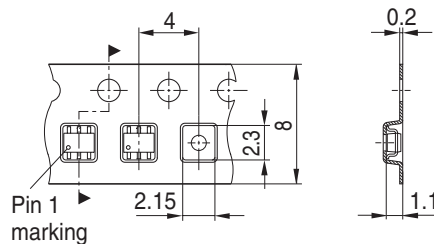

Edition 2009-11-16

**Published by
Infineon Technologies AG
81726 Munich, Germany**

**© 2009 Infineon Technologies AG
All Rights Reserved.**

Legal Disclaimer

The information given in this document shall in no event be regarded as a guarantee of conditions or characteristics. With respect to any examples or hints given herein, any typical values stated herein and/or any information regarding the application of the device, Infineon Technologies hereby disclaims any and all warranties and liabilities of any kind, including without limitation, warranties of non-infringement of intellectual property rights of any third party.

Information

For further information on technology, delivery terms and conditions and prices, please contact the nearest Infineon Technologies Office ([<www.infineon.com>](http://www.infineon.com)).



Warnings

Due to technical requirements, components may contain dangerous substances. For information on the types in question, please contact the nearest Infineon Technologies Office.

Infineon Technologies components may be used in life-support devices or systems only with the express written approval of Infineon Technologies, if a failure of such components can reasonably be expected to cause the failure of that life-support device or system or to affect the safety or effectiveness of that device or system. Life support devices or systems are intended to be implanted in the human body or to support and/or maintain and sustain and/or protect human life. If they fail, it is reasonable to assume that the health of the user or other persons may be endangered.

Looking for pricing, stock, or lifecycle information?

Click below to explore more details on WIN SOURCE:

-  [View ESD5V3U4RRSE6327HTSA1 on WIN SOURCE](#)
-  [Infineon Technologies Information](#)

Optimize Your Supply Chain with WIN SOURCE Solutions

-  Global Sourcing Solution
-  Obsolete Management
-  Cost Control Management
-  Shortage Management
-  Alternative Solution
-  Excess Inventory Management