



**THE DATASHEET OF  
ATF-52189-BLK**



# ATF-52189

## High Linearity Mode<sup>[1]</sup> Enhancement

### Pseudomorphic HEMT in SOT 89 Package



## Data Sheet

### Description

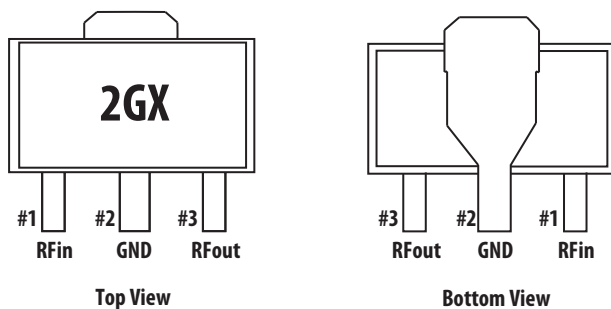
Avago Technologies's ATF-52189 is a single-voltage high linearity, low noise E-pHEMT FET packaged in a low cost surface mount SOT89 package. The device is ideal as a medium-power, high-linearity amplifier. Its operating frequency range is from 50 MHz to 6 GHz.

ATF-52189 is ideally suited for Cellular/PCS and WCDMA wireless infrastructure, WLAN, WLL and MMDS application, and general purpose discrete E-pHEMT amplifiers which require medium power and high linearity. All devices are 100% RF and DC tested.

#### Notes:

1. Enhancement mode technology employs a single positive  $V_{gs}$ , eliminating the need of negative gate voltage associated with conventional depletion mode devices.
2. Refer to reliability datasheet for detailed MTTF data
3. Conform to JEDEC reference outline MO229 for DRP-N
4. Linearity Figure of Merit (LFOM) is OIP3 divided by DC bias power

### Pin Connections and Package Marking



#### Notes:

Package marking provides orientation and identification:  
 "2G" = Device Code  
 "x" = Month code indicates the month of manufacture.

### Features

- Single voltage operation
- High Linearity and P1dB
- Low Noise Figure
- Excellent uniformity in product specifications
- SOT 89 standard package
- Point MTTF > 300 years<sup>[2]</sup>
- MSL-2 and lead-free
- Tape-and-Reel packaging option available

### Specifications

2 GHz, 4.5V, 280 mA (Typ.)

- 42 dBm Output IP3
- 27 dBm Output Power at 1dB gain compression
- 1.50 dB Noise Figure
- 16.0 dB Gain
- 55% PAE at P1dB
- LFOM<sup>[3]</sup> 12.5 dB

### Applications

- Front-end LNA Q2 and Q3, Driver or Pre-driver Amplifier for Cellular/PCS and WCDMA wireless infrastructure
- Driver Amplifier for WLAN, WLL/RLL and MMDS applications
- General purpose discrete E-pHEMT for other high linearity applications

## ATF-52189 Absolute Maximum Ratings<sup>[1]</sup>

Symbol	Parameter	Units	Absolute Maximum
$V_{ds}$	Drain–Source Voltage <sup>[2]</sup>	V	7
$V_{gs}$	Gate–Source Voltage <sup>[2]</sup>	V	-5 to 1.0
$V_{gd}$	Gate Drain Voltage <sup>[2]</sup>	V	-5 to 1.0
$I_{ds}$	Drain Current <sup>[2]</sup>	mA	500
$I_{gs}$	Gate Current	mA	46
$P_{diss}$	Total Power Dissipation <sup>[3]</sup>	W	1.5
$P_{in\ max.}$	RF Input Power	dBm	+27
$T_{ch}$	Channel Temperature	°C	150
$T_{stg}$	Storage Temperature	°C	-65 to 150

### Thermal Resistance<sup>[2,4]</sup>

$$\theta_{ch-b} = 52^{\circ}\text{C}/\text{W}$$

#### Notes:

1. Operation of this device above any one of these parameters may cause permanent damage.
2. Assuming DC quiescent conditions.
3. Board (package belly) temperature  $T_B$  is 25°C. Derate 19.25 mW/°C for  $T_B > 72^{\circ}\text{C}$ .
4. Channel-to-board thermal resistance measured using 150°C Liquid Crystal Measurement method.

## ATF-52189 Electrical Specifications

$T_A = 25^{\circ}\text{C}$ , DC bias for RF parameters is  $V_{ds} = 4.5\text{V}$  and  $I_{ds} = 200\text{ mA}$  unless otherwise specified.

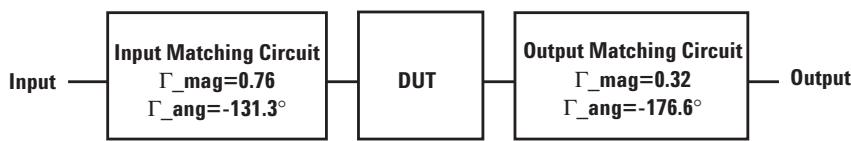
Symbol	Parameters and Test Conditions	Units	Min.	Typ.	Max.	
$V_{gs}$	Operational Gate Voltage	$V_{ds} = 4.5\text{V}, I_{ds} = 200\text{ mA}$	V	—	0.62	—
$V_{th}$	Threshold Voltage	$V_{ds} = 4.5\text{V}, I_{ds} = 16\text{ mA}$	V	—	0.28	—
$I_{ds}$	Drain to Source Current	$V_{ds} = 4.5\text{V}, V_{gs} = 0\text{V}$	μA	—	14.8	—
$G_m$	Transconductance	$V_{ds} = 4.5\text{V}, G_m = \Delta I_{ds} / \Delta V_{gs};$ $\Delta V_{gs} = V_{gs1} - V_{gs2}$ $V_{gs1} = 0.55\text{V}, V_{gs2} = 0.5\text{V}$	mmho	—	1300	—
$I_{gss}$	Gate Leakage Current	$V_{ds} = 0\text{V}, V_{gs} = -4\text{V}$	μA	-20.0	0.49	—
NF	Noise Figure	$f = 2\text{ GHz}$ $f = 900\text{ MHz}$	dB dB	— —	1.50 1.25	— —
G	Gain <sup>[1]</sup>	$f = 2\text{ GHz}$ $f = 900\text{ MHz}$	dB dB	14.8 —	16.0 16.5	17.8 —
OIP3	Output 3 <sup>rd</sup> Order Intercept Point <sup>[1]</sup>	$f = 2\text{ GHz}$ $f = 900\text{ MHz}$	dBm dBm	38.5 —	42.0 42.0	— —
P1dB	Output 1dB Compressed <sup>[1]</sup>	$f = 2\text{ GHz}$ $f = 900\text{ MHz}$	dBm dBm	25.5 —	27.0 27.2	— —
PAE	Power Added Efficiency	$f = 2\text{ GHz}$ $f = 900\text{ MHz}$	% %	40.0 —	55.0 50.0	— —
NF	Noise Figure	$f=900\text{ MHz}$ $f=2.0\text{ GHz}$ $f=2.4\text{ GHz}$	dB dB dB	— — —	1.25 1.50 1.60	— — —
G	Gain <sup>[1]</sup>	$f=900\text{ MHz}$ $f=2.0\text{ GHz}$ $f=2.4\text{ GHz}$	dB dB dB	— 14.8 —	16.5 16.0 13.5	— 17.8 —
OIP3	Output 3rd Order Intercept Point <sup>[1]</sup>	$f=900\text{ MHz}$ $f=2.0\text{ GHz}$ $f=2.4\text{ GHz}$	dBm dBm dBm	— 38.5 —	42.0 42.0 41.0	— — —
P1dB	Output 1dB Compressed <sup>[1]</sup>	$f=900\text{ MHz}$ $f=2.0\text{ GHz}$ $f=2.4\text{ GHz}$	dBm dBm dBm	— 25.5 —	27.2 27.0 26.0	— — —

continued on next page

Symbol	Parameters and Test Conditions	Units	Min.	Typ.	Max.
PAE	Power Added Efficiency	f=900 MHz	—	50.0	—
		f=2.0 GHz	40.0	55.0	—
		f=2.4 GHz	—	52.0	—
ACLR	Adjacent Channel Leakage Power Ratio <sup>[1,2]</sup>	Offset BW = 5 MHz	—	-58.0	—
		Offset BW = 10 MHz	—	-66.0	—

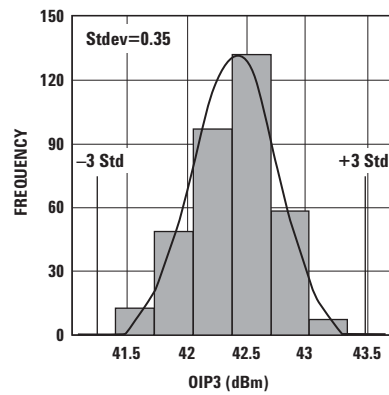
**Notes:**

- Measurements at 2 GHz obtained using production test board described in Figure 1.
- ACLR test spec is based on 3GPP TS 25.141 V5.3.1 (2002-06)
  - Test Model 1
  - Active Channels: PCCPCH + SCH + CPICH + PICH + SCCPCH + 64 DPCH (SF=128)
  - Freq = 2140 MHz
  - Pin = -8 dBm
  - Channel Integrate Bandwidth = 3.84 MHz

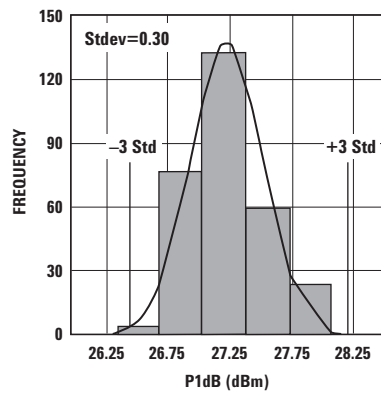


**Figure 1. Block diagram of the 2 GHz production test board used for NF, Gain, OIP3, P1dB, PAE and ACLR measurements. This circuit achieves a trade-off between optimal OIP3, P1dB and VSWR. Circuit losses have been de-embedded from actual measurements.**

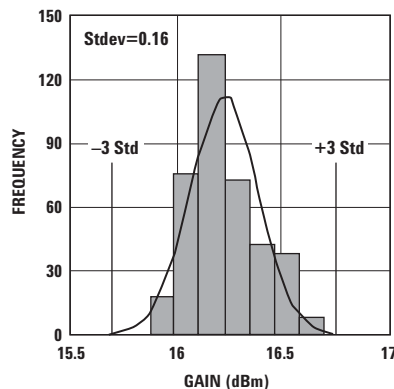
**Product Consistency Distribution Charts<sup>[1,2]</sup>**



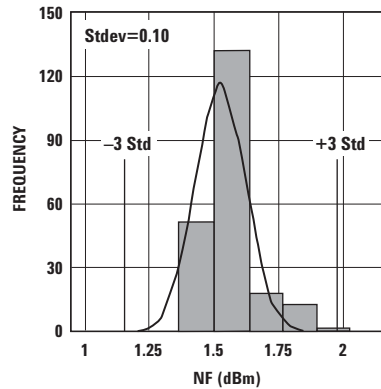
**Figure 2. OIP3 @ 2 GHz, 4.5V/200 mA. LSL = 38.5 dBm, Nominal = 42.4 dBm.**



**Figure 3. P1dB @ 2 GHz, 4.5V, 200 mA. LSL = 25.5 dBm, Nominal = 27.1 dBm.**



**Figure 4. Gain @ 2 GHz, 4.5V, 200 mA. LSL = 14.8 dBm, Nominal = 16.1 dBm, USL = 17.8 dB.**



**Figure 5. NF @ 2 GHz, 4.5V, 200 mA. Nominal = 1.5 dBm.**

**Notes:**

- Distribution data sample size is 500 samples taken from 3 different wafers. Future wafers allocated to this product may have nominal values anywhere between the upper and lower limits.
- Measurements are made on production test board, which represents a trade-off between optimal OIP3, P1dB and VSWR. Circuit losses have been de-embedded from actual measurements.

### Gamma Load and Source at Optimum OIP3 and P1dB Tuning Conditions

The device's optimum OIP3 and P1dB measurements were determined using a Maury Load Pull System at 4.5V, 200 mA quiescent bias.

#### Typical Gammas at Optimum OIP3<sup>[1]</sup>

Freq (GHz)	Gamma Source		Gamma Load		OIP3 (dBm)	Gain (dB)	P1dB (dBm)	PAE (%)
	Mag	Ang (deg)	Mag	Ang (deg)				
0.9	0.7511	-132.82	0.6444	-157.38	42.0	16.5	27.2	49.7
2.0	0.7577	-131.31	0.3236	-176.55	42.0	15.7	26.8	54.9
2.4	0.7625	-128.49	0.2665	-148.09	41.0	13.6	26.5	49.5
3.9	0.7432	-94.91	0.4125	-98.27	40.0	10.8	27.3	49.1

#### Typical Gammas at Optimum P1dB<sup>[1]</sup>

Freq (GHz)	Gamma Source		Gamma Load		OIP3 (dBm)	Gain (dB)	P1dB (dBm)	PAE (%)
	Mag	Ang (deg)	Mag	Ang (deg)				
0.9	0.7786	139.82	0.5494	-177.76	38.6	17.3	28.4	58.3
2.0	0.7052	-168.54	0.6981	-165.37	37.5	14.8	29.0	48.6
2.4	0.7117	-161.45	0.6624	-159.44	37.3	12.0	29.3	48.2
3.9	0.3379	-100.92	0.6151	-126.28	37.0	9.1	28.0	46.2

**Note:**

1. Typical describes additional product performance information that is not covered by the product warranty.

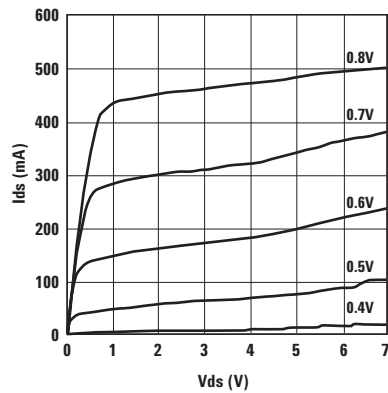


Figure 6. Typical IV Curve.

**ATF-52189 Typical Performance Curves (at 25°C unless specified otherwise)  
Tuned for Optimal OIP3 at  $V_d = 4.5V$ ,  $I_{ds} = 200\text{ mA}$ .**

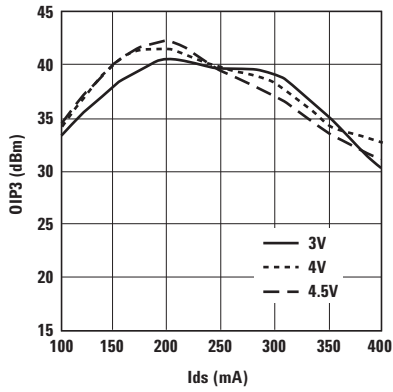


Figure 7. OIP3 vs.  $I_{ds}$  and  $V_{ds}$  at 900 MHz.

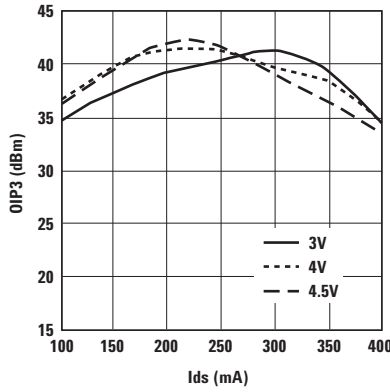


Figure 8. OIP3 vs.  $I_{ds}$  and  $V_{ds}$  at 2 GHz.

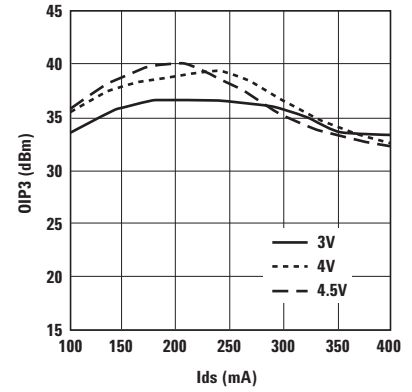


Figure 9. OIP3 vs.  $I_{ds}$  and  $V_{ds}$  at 3.9 GHz.

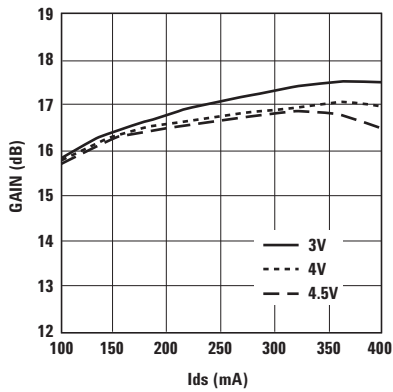


Figure 10. Small Signal Gain vs.  $I_{ds}$  and  $V_{ds}$  at 900 MHz.

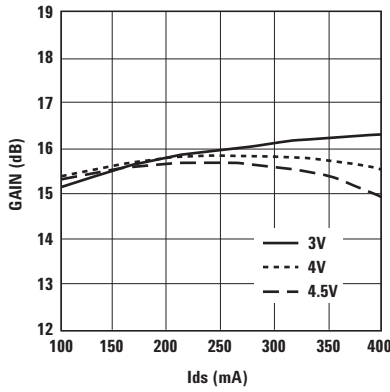


Figure 11. Small Signal Gain vs.  $I_{ds}$  and  $V_{ds}$  at 2 GHz.

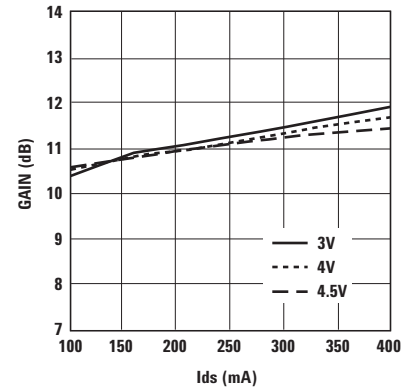


Figure 12. Small Signal Gain vs.  $I_{ds}$  and  $V_{ds}$  at 3.9 GHz.

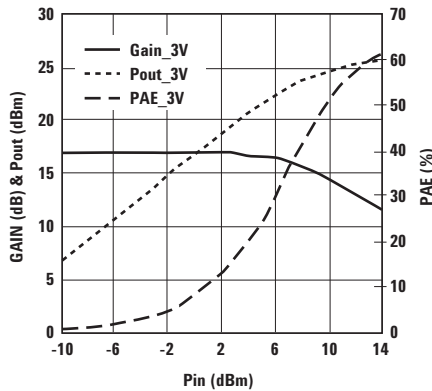


Figure 13. Small Signal Gain/Pout/PAE vs.  $P_{in}$  at  $V_{ds} = 3V$  and Frequency = 900 MHz.

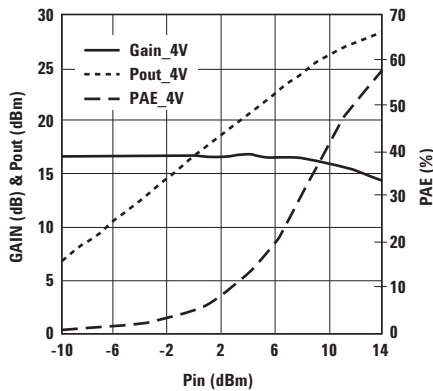


Figure 14. Small Signal Gain/Pout/PAE vs.  $P_{in}$  at  $V_{ds} = 4V$  and Frequency = 900 MHz.

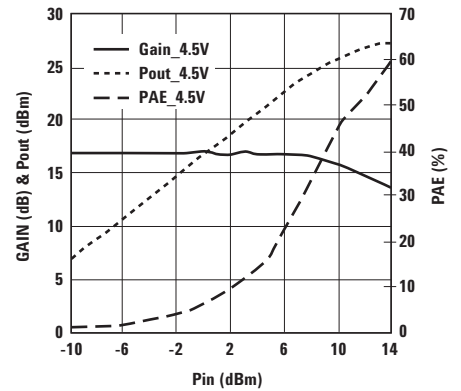
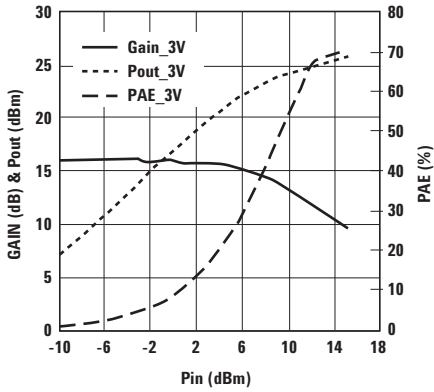


Figure 15. Small Signal Gain/Pout/PAE vs.  $P_{in}$  at  $V_{ds} = 4.5V$  and Frequency = 900 MHz.

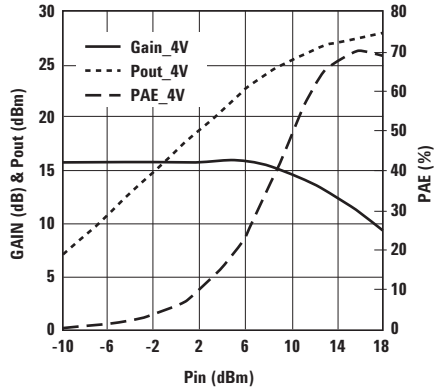
**Note:**

Bias current for the above charts are quiescent conditions. Actual level may increase depending on amount of RF drive.

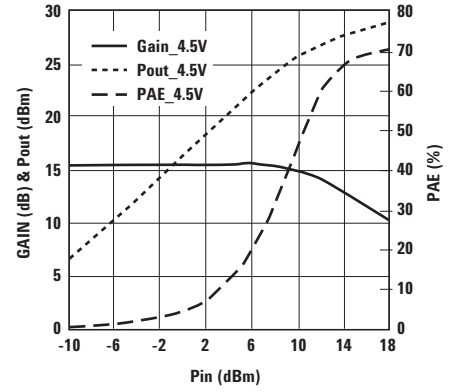
**ATF-52189 Typical Performance Curves (at 25°C unless specified otherwise), continued**  
**Tuned for Optimal OIP3 at Vd = 4.5V, Ids = 200 mA.**



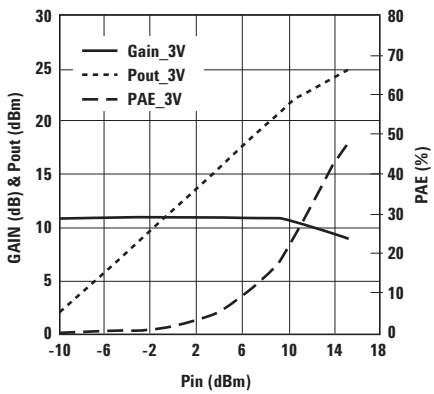
**Figure 16. Small Signal Gain/Pout/PAE vs. Pin at Vds = 3V and Frequency = 2 GHz.**



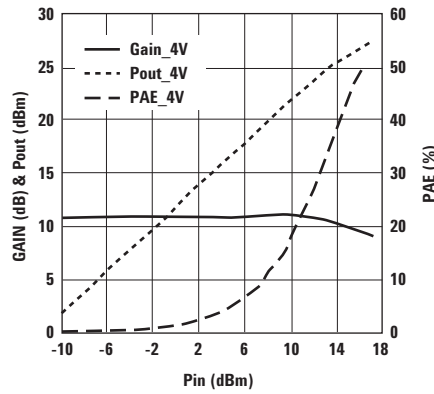
**Figure 17. Small Signal Gain/Pout/PAE vs. Pin at Vds = 4V and Frequency = 2 GHz.**



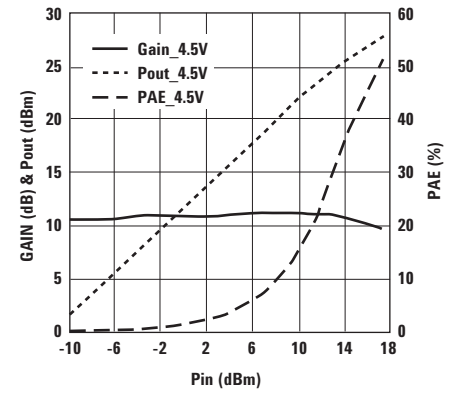
**Figure 18. Small Signal Gain/Pout/PAE vs. Pin at Vds = 4.5V and Frequency = 2 GHz.**



**Figure 19. Small Signal Gain/Pout/PAE vs. Pin at Vds = 3V and Frequency = 3.9 GHz.**



**Figure 20. Small Signal Gain/Pout/PAE vs. Pin at Vds = 4V and Frequency = 3.9 GHz.**

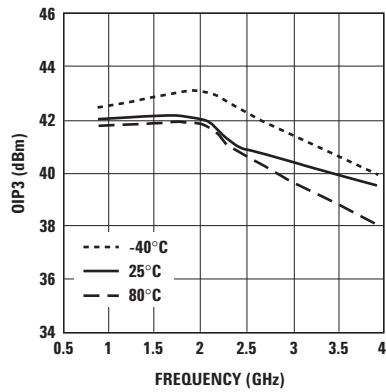


**Figure 21. Small Signal Gain/Pout/PAE vs. Pin at Vds = 4.5V and Frequency = 3.9 GHz.**

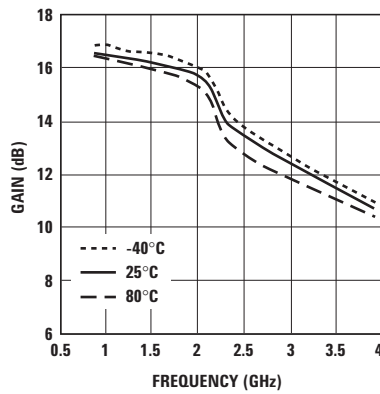
**Note:**

Bias current for the above charts are quiescent conditions. Actual level may increase depending on amount of RF drive.

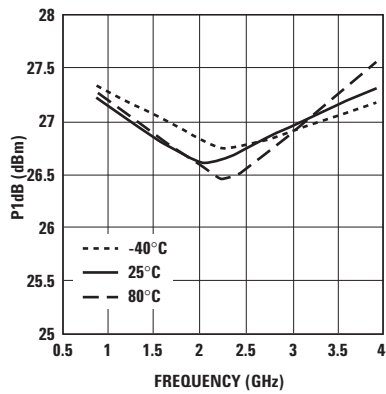
**ATF-52189 Typical Performance Curves, continued**  
**Tuned for Optimal OIP3 at  $V_d = 4.5V$ ,  $I_{ds} = 200\text{ mA}$ , Over Temperature and Frequency**



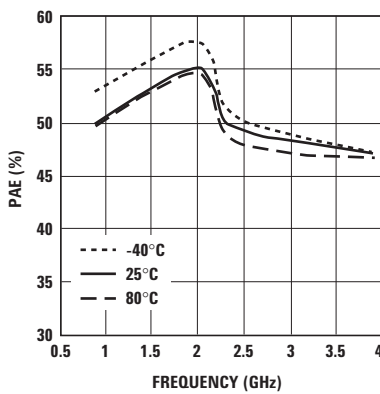
**Figure 22. OIP3 vs. Temperature and Frequency at optimum OIP3.**



**Figure 23. Gain vs. Temperature and Frequency at optimum OIP3.**



**Figure 24. P1dB vs. Temperature and Frequency at optimum OIP3.**



**Figure 25. PAE vs. Temperature and Frequency at optimum OIP3.**

**Note:**

Bias current for the above charts are quiescent conditions. Actual level may increase depending on amount of RF drive.

**ATF-52189 Typical Performance Curves, (at 25°C unless specified otherwise)  
Tuned for Optimal P1dB at Vd = 4.5V, I<sub>ds</sub> = 200 mA.**

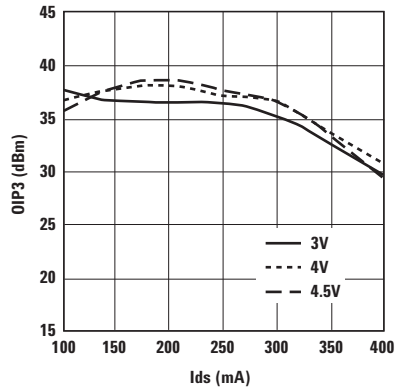


Figure 26. OIP3 vs I<sub>ds</sub> and V<sub>ds</sub> at 900 MHz.

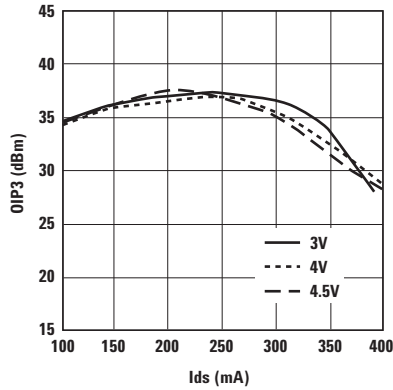


Figure 27. OIP3 vs. I<sub>ds</sub> and V<sub>ds</sub> at 2 GHz.

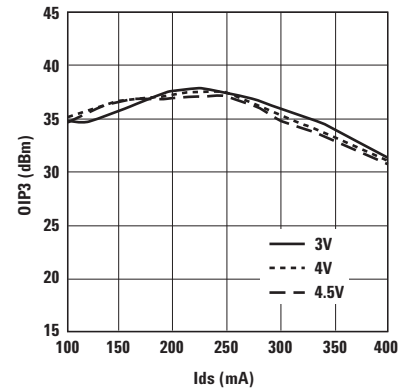


Figure 28. OIP3 vs I<sub>ds</sub> and V<sub>ds</sub> at 3.9 GHz.

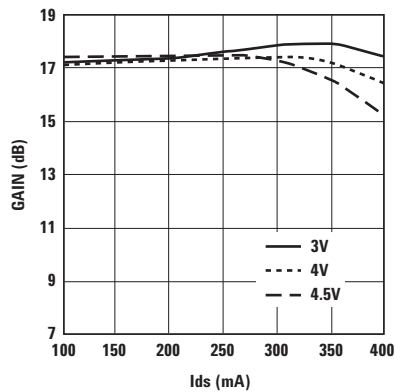


Figure 29. Small Signal Gain vs. I<sub>ds</sub> and V<sub>ds</sub> at 900 MHz.

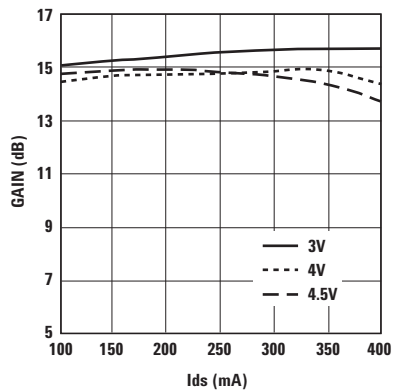


Figure 30. Small Signal Gain vs. I<sub>ds</sub> and V<sub>ds</sub> at 2 GHz.

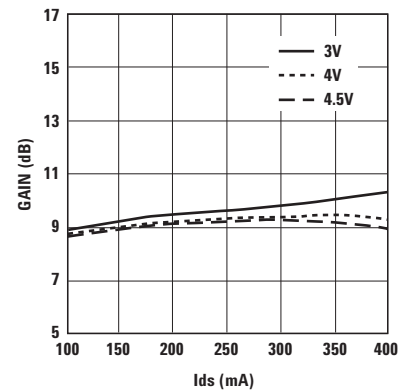


Figure 31. Small Signal Gain vs. I<sub>ds</sub> and V<sub>ds</sub> at 3.9 GHz.

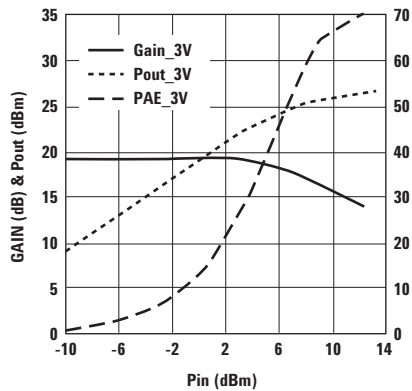


Figure 32. Small Signal Gain/Pout/PAE vs. Pin at V<sub>ds</sub> = 3V and Frequency = 900 MHz.

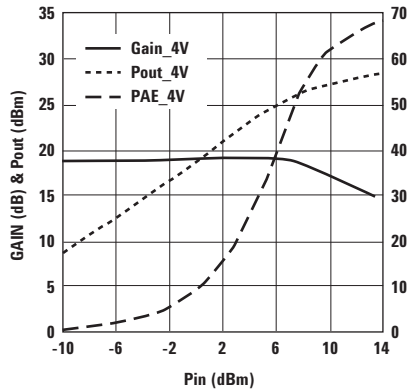


Figure 33. Small Signal Gain/Pout/PAE vs. Pin at V<sub>ds</sub> = 4V and Frequency = 900 MHz.

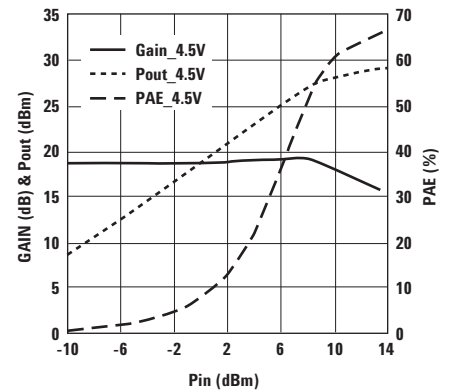
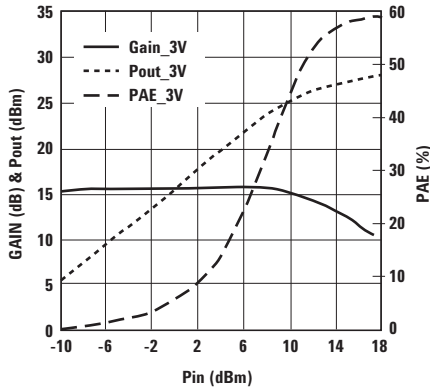


Figure 34. Small Signal Gain/Pout/PAE vs. Pin at V<sub>ds</sub> = 4.5V and Frequency = 900 MHz.

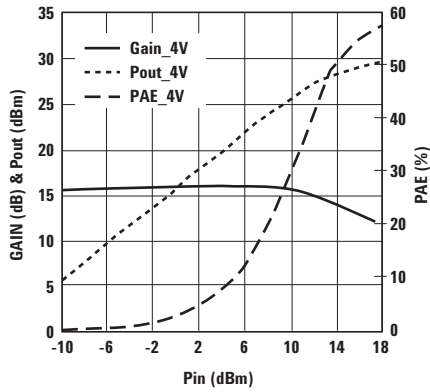
**Note:**

Bias current for the above charts are quiescent conditions. Actual level may increase depending on amount of RF drive.

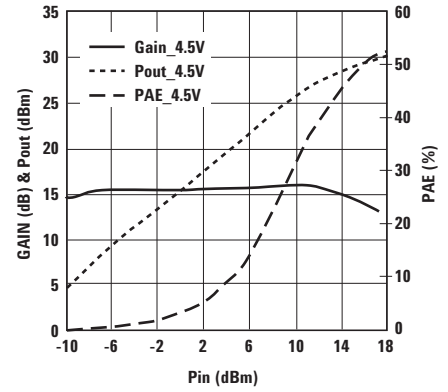
**ATF-52189 Typical Performance Curves** (at 25°C unless specified otherwise), continued  
**Tuned for Optimal P1dB at Vd = 4.5V, Ids = 200 mA.**



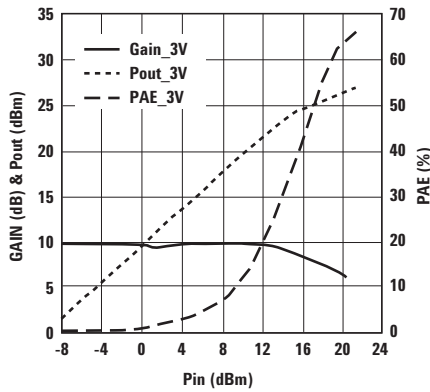
**Figure 35. Small Signal Gain/Pout/PAE vs. Pin at Vds = 3V and Frequency = 2 GHz.**



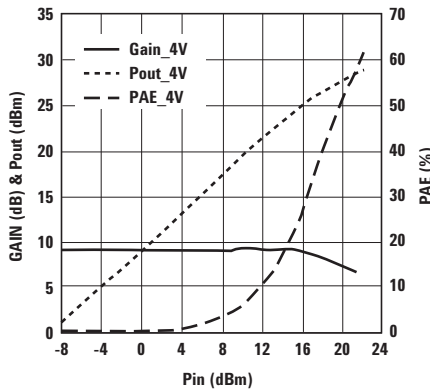
**Figure 36. Small Signal Gain/Pout/PAE vs. Pin at Vds = 4V and Frequency = 2 GHz.**



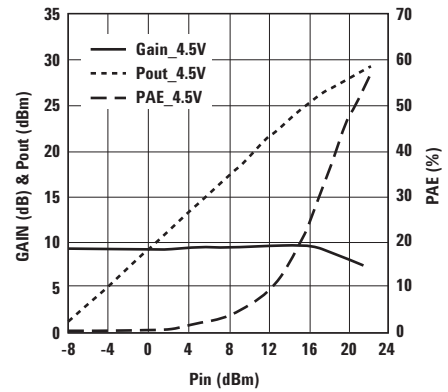
**Figure 37. Small Signal Gain/Pout/PAE vs. Pin at Vds = 4.5V and Frequency = 2 GHz.**



**Figure 38. Small Signal Gain/Pout/PAE vs. Pin at Vds = 3V and Frequency = 3.9 GHz.**



**Figure 39. Small Signal Gain/Pout/PAE vs. Pin at Vds = 4V and Frequency = 3.9 GHz.**

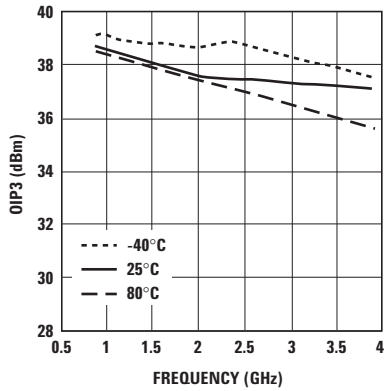


**Figure 40. Small Signal Gain/Pout/PAE vs. Pin at Vds = 4.5V and Frequency = 3.9 GHz.**

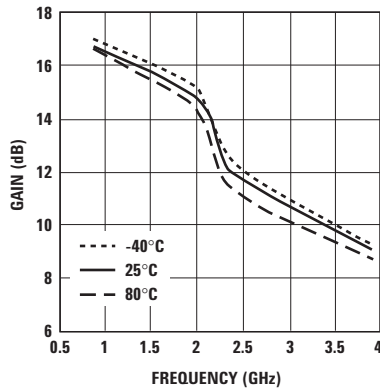
**Note:**

Bias current for the above charts are quiescent conditions. Actual level may increase depending on amount of RF drive.

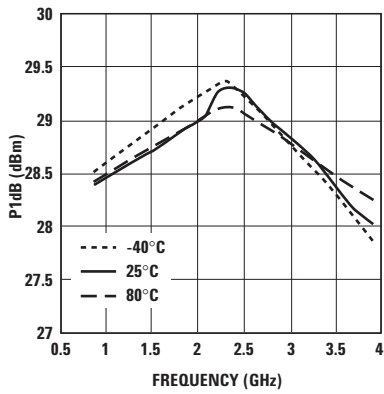
**ATF-52189 Typical Performance Curves, continued**  
**Tuned for Optimal P1dB at  $V_d = 4.5V$ ,  $I_{ds} = 200\text{ mA}$ , Over Temperature and Frequency.**



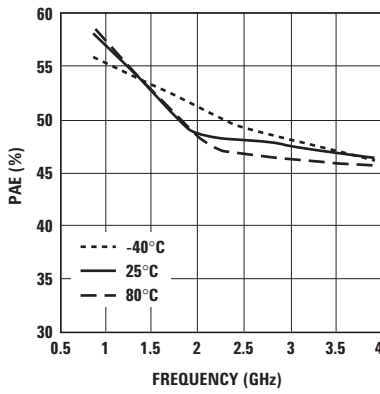
**Figure 41. OIP3 vs. Temperature and Frequency at optimum P1dB.**



**Figure 42. Gain vs. Temperature and Frequency at optimum P1dB.**



**Figure 43. P1dB vs. Temperature and Frequency at optimum P1dB.**

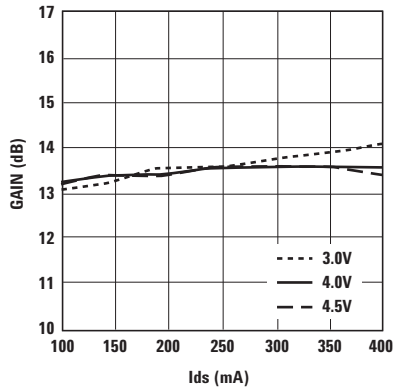


**Figure 44. PAE vs. Temperature and Frequency at optimum P1dB.**

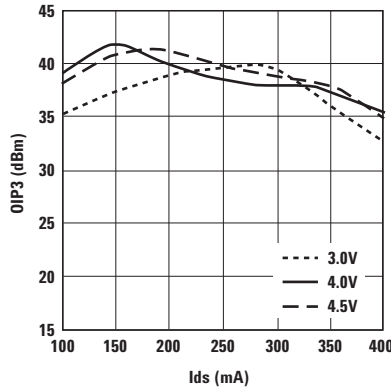
**Note:**

Bias current for the above charts are quiescent conditions. Actual level may increase depending on amount of RF drive.

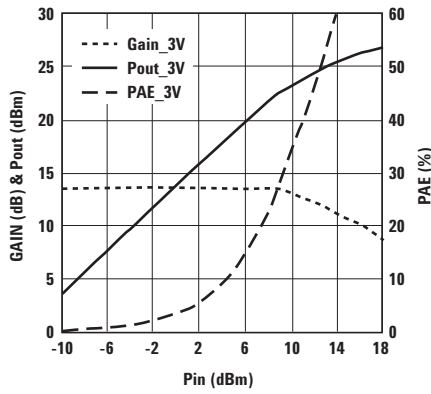
**ATF-52189 Typical Performance Curves (at 25°C unless specified otherwise), continued**  
**Tuned for Optimal OIP3 at  $V_d = 4.5V$ ,  $I_{ds} = 200\text{ mA}$ .**



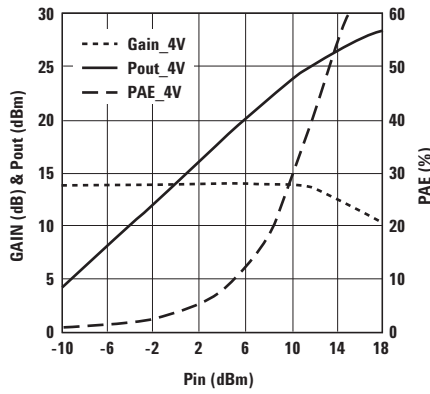
**Figure 45. OIP3 vs.  $I_{ds}$  and  $V_{ds}$  at 2.4 GHz.**



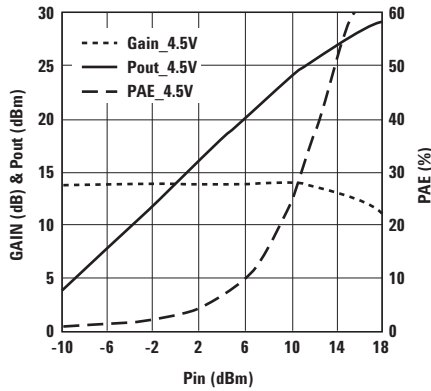
**Figure 46. Small Signal Gain vs.  $I_{ds}$  and  $V_{ds}$  at 2.4 GHz.**



**Figure 47. Small Signal Gain/Pout/PAE vs. Pin at  $V_{ds}$  3V and Freq = 2.4 GHz.**



**Figure 48. Small Signal Gain/Pout/PAE vs. Pin at  $V_{ds}$  4V and Freq = 2.4 GHz.**



**Figure 49. Small Signal Gain/Pout/PAE vs. Pin at  $V_{ds}$  4.5V and Freq = 2.4 GHz.**

**Note:**

Bias current for the above charts are quiescent conditions. Actual level may increase depending on amount of RF drive.

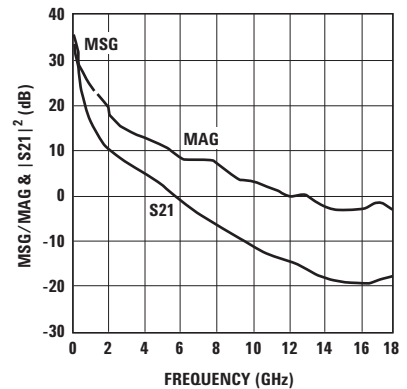
**ATF-52189 Typical Scattering and Noise Parameters at 25°C,  $V_{DS} = 4.5V$ ,  $I_{DS} = 280$  mA**

Freq (GHz)	S11			S21			S12			S22		MSG/MAG dB
	Mag.	Ang.	(dB)	Mag.	Ang.	(dB)	Mag.	Ang.	Mag.	Ang.		
0.1	0.544	-91.7	31.93	39.502	144.2	-39.17	0.011	52.6	0.289	-99.7	35.55	
0.2	0.704	-128.0	29.23	28.943	122.7	-35.39	0.017	40.4	0.397	-130.4	32.31	
0.3	0.777	-146.6	26.78	21.823	109.6	-33.98	0.020	33.2	0.446	-145.8	30.38	
0.4	0.813	-158.4	24.74	17.257	100.6	-33.15	0.022	28.6	0.470	-155.3	28.95	
0.5	0.856	-171.5	21.75	12.238	93.9	-33.98	0.020	26.1	0.551	-170.8	27.87	
0.6	0.866	-176.8	20.26	10.303	89.3	-33.56	0.021	25.4	0.559	-174.5	26.91	
0.7	0.872	178.8	19.00	8.913	85.4	-33.56	0.021	25.1	0.562	-177.5	26.28	
0.8	0.874	175.1	17.92	7.866	81.8	-33.15	0.022	25.0	0.564	179.8	25.53	
0.9	0.876	171.6	16.96	7.050	78.4	-32.77	0.023	25.0	0.564	177.4	24.86	
1.0	0.880	168.4	16.08	6.366	75.3	-32.40	0.024	25.0	0.563	175.2	24.24	
1.5	0.881	154.5	12.74	4.333	61.0	-31.06	0.028	24.2	0.558	165.5	21.90	
2.0	0.882	141.6	10.39	3.309	47.5	-29.63	0.033	21.5	0.549	156.5	18.26	
2.5	0.879	128.6	8.63	2.702	34.1	-28.18	0.039	16.7	0.542	147.4	16.05	
3.0	0.874	115.1	7.31	2.320	20.5	-27.26	0.043	9.6	0.543	138.9	14.47	
3.5	0.882	105.8	6.39	2.087	9.7	-26.92	0.045	3.3	0.560	130.4	13.83	
4.0	0.889	96.5	5.36	1.853	-1.2	-26.60	0.047	-3.1	0.578	121.8	13.09	
5.0	0.903	77.9	2.83	1.385	-22.8	-25.98	0.050	-15.7	0.613	104.8	11.24	
6.0	0.918	59.3	-0.75	0.918	-44.5	-25.41	0.054	-28.4	0.648	87.7	8.51	
7.0	0.948	43.4	-3.31	0.683	-63.8	-26.02	0.050	-39.9	0.687	74.6	8.14	
8.0	0.960	31.6	-5.68	0.520	-81.4	-26.74	0.046	-51.6	0.729	61.0	7.41	
9.0	0.941	23.4	-8.20	0.389	-96.9	-28.18	0.039	-63.8	0.773	47.8	4.33	
10.0	0.946	14.0	-10.29	0.306	-112.0	-29.63	0.033	-80.6	0.805	36.5	3.52	
11.0	0.937	3.1	-12.11	0.248	-128.9	-32.77	0.023	-113.1	0.825	26.9	2.11	
12.0	0.914	-3.8	-13.68	0.207	-143.7	-37.72	0.013	-154.6	0.843	16.9	-0.19	
13.0	0.951	-15.1	-15.70	0.164	-163.9	-37.08	0.014	106.3	0.842	7.7	0.27	
14.0	0.948	-19.8	-17.79	0.129	-172.6	-37.72	0.013	51.0	0.849	1.1	-2.38	
15.0	0.939	-21.2	-18.56	0.118	179.7	-41.94	0.008	60.4	0.879	-4.4	-2.87	
16.0	0.948	-24.7	-18.94	0.113	171.7	-46.02	0.005	71.8	0.876	-8.4	-2.64	
17.0	0.947	-33.0	-17.99	0.126	157.7	-38.42	0.012	123.0	0.884	-13.3	-1.07	
18.0	0.903	-45.1	-17.14	0.139	140.5	-33.98	0.020	114.5	0.859	-21.3	-3.66	

Freq GHz	Fmin dB	Gamma Opt Mag	Gamma Opt Ang	Rn/50	Ga dB
0.5	1.45	0.704	-175.0	0.23	21.63
1.0	1.60	0.706	-162.6	0.15	18.91
2.0	1.90	0.727	-137.5	0.10	16.10
3.0	2.20	0.763	-112.8	0.14	12.97
4.0	2.46	0.804	-91.9	0.27	11.03
5.0	2.79	0.855	-68.9	0.61	9.62
6.0	3.09	0.896	-51.5	0.81	8.46
7.0	3.39	0.923	-38.6	1.02	7.62
8.0	3.69	0.930	-31.0	1.42	6.50

**Notes:**

1.  $F_{min}$  values at 2 GHz and higher are based on measurements while the  $F_{min}$  below 2 GHz have been extrapolated. The  $F_{min}$  values are based on a set of 16 noise figure measurements made at 16 different impedances using an ATN NP5 test system. From these measurements a true  $F_{min}$  is calculated. Refer to the noise parameter application section for more information.
2. S and noise parameters are measured on a microstrip line made on 0.025 inch thick alumina carrier. The input reference plane is at the end of the gate lead. The output reference plane is at the end of the drain lead.



**Figure 50. MSG/MAG &  $|S21|^2$  vs. Frequency at 4.5V/280 mA.**

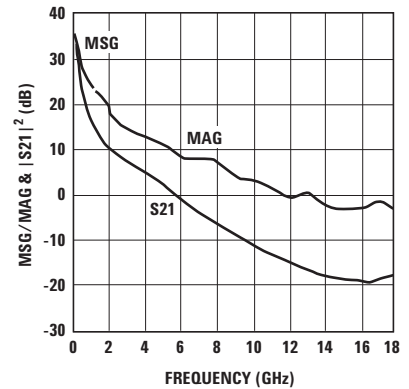
**ATF-52189 Typical Scattering and Noise Parameters at 25°C,  $V_{DS} = 4.5V$ ,  $I_{DS} = 200$  mA**

Freq (GHz)	S11			S21			S12		S22		MSG/MAG dB
	Mag.	Ang.	(dB)	Mag.	Ang.	(dB)	Mag.	Ang.	Mag.	Ang.	
0.1	0.848	-84.4	33.58	47.752	136.0	-37.08	0.014	51.6	0.360	-104.6	35.33
0.2	0.856	-124.7	30.01	31.649	114.6	-34.42	0.019	35.9	0.442	-136.7	32.22
0.3	0.863	-144.9	27.16	22.811	102.9	-33.15	0.022	28.7	0.473	-151.3	30.16
0.4	0.868	-157.3	24.94	17.656	95.1	-32.77	0.023	24.7	0.487	-159.9	28.85
0.5	0.882	-170.8	21.81	12.320	89.4	-33.56	0.021	22.5	0.562	-173.9	27.68
0.6	0.885	-176.3	20.27	10.315	85.5	-33.56	0.021	22.2	0.567	-177.2	26.91
0.7	0.886	179.2	18.98	8.894	82.0	-33.15	0.022	22.1	0.568	-179.8	26.07
0.8	0.886	175.4	17.88	7.831	78.8	-32.77	0.023	22.1	0.568	177.7	25.32
0.9	0.885	171.9	16.91	7.007	75.8	-32.40	0.024	22.3	0.567	175.6	24.65
1.0	0.887	168.6	16.01	6.320	72.9	-32.40	0.024	22.4	0.566	173.6	24.21
1.5	0.886	154.7	12.65	4.291	59.3	-30.75	0.029	22.1	0.560	164.3	21.70
2.0	0.886	141.7	10.29	3.271	46.3	-29.37	0.034	19.7	0.549	155.6	18.69
2.5	0.881	128.7	8.52	2.668	33.1	-28.18	0.039	15.0	0.543	146.6	16.11
3.0	0.879	116.3	7.28	2.312	20.4	-27.38	0.043	8.7	0.548	138.1	14.68
3.5	0.885	106.8	6.33	2.073	9.5	-27.01	0.045	2.5	0.564	129.6	13.97
4.0	0.891	97.4	5.27	1.835	-1.4	-26.65	0.047	-3.8	0.580	121.0	13.15
5.0	0.903	78.4	2.66	1.358	-23.2	-25.98	0.050	-16.3	0.613	104.0	11.08
6.0	0.915	59.5	-1.10	0.881	-45.0	-25.35	0.054	-28.8	0.645	86.9	8.05
7.0	0.948	43.4	-3.44	0.673	-64.1	-26.02	0.050	-40.5	0.686	74.4	8.04
8.0	0.960	31.6	-5.78	0.514	-81.8	-26.74	0.046	-52.4	0.729	60.9	7.37
9.0	0.941	23.4	-8.34	0.383	-97.0	-28.18	0.039	-64.2	0.772	47.7	4.20
10.0	0.945	14.0	-10.40	0.302	-112.0	-29.63	0.033	-80.8	0.805	36.5	3.35
11.0	0.938	3.0	-12.32	0.242	-129.2	-33.15	0.022	-113.9	0.826	26.8	1.99
12.0	0.914	-3.7	-13.89	0.202	-144.1	-38.42	0.012	-156.0	0.843	16.9	-0.42
13.0	0.953	-15.1	-15.86	0.161	-164.5	-37.72	0.013	98.9	0.843	7.7	0.22
14.0	0.946	-19.8	-17.92	0.127	-172.6	-39.17	0.011	49.2	0.849	1.0	-2.67
15.0	0.939	-21.2	-18.64	0.117	178.8	-43.10	0.007	72.1	0.877	-4.5	-2.97
16.0	0.948	-24.7	-19.17	0.110	170.6	-44.44	0.006	76.0	0.874	-8.4	-2.92
17.0	0.947	-33.1	-18.13	0.124	157.2	-38.42	0.012	119.6	0.883	-13.2	-1.28
18.0	0.900	-45.1	-17.27	0.137	140.4	-33.98	0.020	115.7	0.859	-21.3	-3.92

Freq GHz	Fmin dB	Gamma Opt		Rn/50	Ga dB
		Mag	Ang		
0.5	0.92	0.409	177.1	0.15	19.38
1.0	1.02	0.480	-169.1	0.10	17.52
2.0	1.21	0.602	-141.8	0.08	15.64
3.0	1.41	0.700	-115.6	0.12	12.74
4.0	1.59	0.772	-93.6	0.23	11.05
5.0	1.81	0.841	-69.9	0.54	9.72
6.0	2.01	0.891	-52.2	0.70	8.62
7.0	2.21	0.931	-39.1	0.98	7.78
8.0	2.41	0.965	-31.5	1.33	6.72

**Notes:**

1.  $F_{min}$  values at 2 GHz and higher are based on measurements while the  $F_{min}$  below 2 GHz have been extrapolated. The  $F_{min}$  values are based on a set of 16 noise figure measurements made at 16 different impedances using an ATN NP5 test system. From these measurements a true  $F_{min}$  is calculated. Refer to the noise parameter application section for more information.
2. S and noise parameters are measured on a microstrip line made on 0.025 inch thick alumina carrier. The input reference plane is at the end of the gate lead. The output reference plane is at the end of the drain lead.



**Figure 51. MSG/MAG &  $|S21|^2$  vs. Frequency at 4.5V/200 mA.**

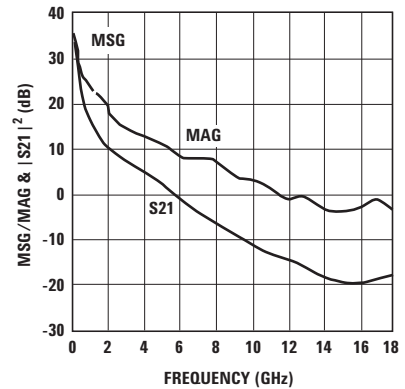
**ATF-52189 Typical Scattering and Noise Parameters at 25°C,  $V_{DS} = 4.5V$ ,  $I_{DS} = 120\text{ mA}$**

Freq (GHz)	S11			S21			S12		S22		MSG/MAG dB
	Mag.	Ang.	(dB)	Mag.	Ang.	(dB)	Mag.	Ang.	Mag.	Ang.	
0.1	0.926	-80.9	33.47	47.170	135.8	-35.92	0.016	51.6	0.389	-96.0	34.70
0.2	0.891	-121.5	29.88	31.192	114.3	-33.15	0.022	34.6	0.447	-131.4	31.52
0.3	0.882	-142.5	27.03	22.457	102.7	-32.04	0.025	26.7	0.471	-147.6	29.53
0.4	0.879	-155.4	24.79	17.360	94.8	-31.70	0.026	22.2	0.482	-157.0	28.25
0.5	0.885	-169.7	21.67	12.120	88.9	-32.77	0.023	19.7	0.551	-172.5	27.22
0.6	0.886	-175.4	20.13	10.145	85.0	-32.40	0.024	19.0	0.555	-176.0	26.26
0.7	0.886	-180.0	18.83	8.743	81.6	-32.40	0.024	18.6	0.557	-178.8	25.61
0.8	0.886	176.1	17.72	7.695	78.4	-32.04	0.025	18.5	0.557	178.7	24.88
0.9	0.885	172.5	16.76	6.883	75.3	-31.70	0.026	18.4	0.555	176.5	24.23
1.0	0.887	169.3	15.86	6.209	72.4	-31.70	0.026	18.3	0.554	174.4	23.78
1.5	0.884	155.1	12.49	4.212	58.8	-30.46	0.030	17.8	0.548	165.1	21.47
2.0	0.884	142.1	10.13	3.210	45.7	-29.12	0.035	15.6	0.538	156.3	19.17
2.5	0.880	129.1	8.36	2.618	32.5	-27.96	0.040	11.2	0.532	147.4	16.16
3.0	0.875	115.5	7.03	2.246	18.9	-27.08	0.044	4.9	0.532	139.0	14.43
3.5	0.882	106.2	6.10	2.018	8.1	-26.80	0.046	-1.1	0.549	130.5	13.76
4.0	0.889	96.8	5.06	1.791	-2.8	-26.54	0.047	-7.1	0.567	122.0	12.99
5.0	0.903	78.1	2.52	1.337	-24.5	-26.04	0.050	-19.0	0.603	105.1	11.06
6.0	0.917	59.4	-1.09	0.882	-46.2	-25.56	0.053	-31.0	0.638	88.1	8.23
7.0	0.947	43.5	-3.64	0.658	-65.5	-26.20	0.049	-42.2	0.681	75.1	7.89
8.0	0.959	31.7	-6.00	0.501	-83.3	-26.74	0.046	-53.9	0.725	61.6	7.19
9.0	0.941	23.4	-8.64	0.370	-98.9	-28.40	0.038	-65.8	0.770	48.2	4.00
10.0	0.946	14.1	-10.69	0.292	-114.3	-29.63	0.033	-82.9	0.805	36.9	3.26
11.0	0.936	3.1	-12.54	0.236	-131.4	-33.15	0.022	-116.4	0.826	27.2	1.71
12.0	0.914	-3.7	-14.24	0.194	-146.0	-37.72	0.013	-159.1	0.843	17.2	-0.74
13.0	0.951	-14.9	-16.25	0.154	-166.9	-37.72	0.013	104.3	0.843	8.0	-0.35
14.0	0.948	-19.8	-18.34	0.121	-175.3	-39.17	0.011	56.9	0.850	1.2	-2.88
15.0	0.937	-21.1	-19.02	0.112	176.1	-40.92	0.009	79.5	0.877	-4.2	-3.46
16.0	0.949	-24.5	-19.66	0.104	167.9	-43.10	0.007	74.4	0.878	-8.2	-3.21
17.0	0.947	-32.9	-18.56	0.118	154.7	-37.72	0.013	117.9	0.887	-13.1	-1.56
18.0	0.906	-45.1	-17.79	0.129	138.1	-33.56	0.021	111.8	0.862	-21.1	-4.11

Freq GHz	Fmin dB	Gamma Opt		Rn/50	Ga dB
		Mag	Ang		
0.5	0.67	0.263	166.7	0.14	19.36
1.0	0.76	0.361	-177.3	0.08	17.64
2.0	0.95	0.524	-146.8	0.06	15.04
3.0	1.13	0.652	-118.4	0.12	12.27
4.0	1.30	0.741	-95.3	0.15	10.83
5.0	1.50	0.826	-70.9	0.30	9.62
6.0	1.68	0.887	-52.9	0.54	8.48
7.0	1.86	0.939	-39.7	0.69	7.85
8.0	1.88	0.989	-31.8	0.97	4.25

**Notes:**

1.  $F_{min}$  values at 2 GHz and higher are based on measurements while the  $F_{min}$  below 2 GHz have been extrapolated. The  $F_{min}$  values are based on a set of 16 noise figure measurements made at 16 different impedances using an ATN NP5 test system. From these measurements a true  $F_{min}$  is calculated. Refer to the noise parameter application section for more information.
2. S and noise parameters are measured on a microstrip line made on 0.025 inch thick alumina carrier. The input reference plane is at the end of the gate lead. The output reference plane is at the end of the drain lead.



**Figure 52. MSG/MAG &  $|S21|^2$  vs. Frequency at 4.5V/120 mA.**

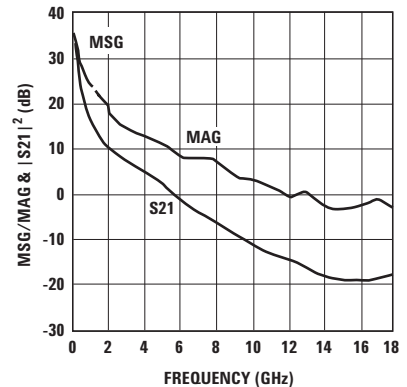
**ATF-52189 Typical Scattering and Noise Parameters at 25°C,  $V_{DS} = 4.0V$ ,  $I_{DS} = 200$  mA**

Freq (GHz)	S11			S21			S12			S22		MSG/MAG dB
	Mag.	Ang.	(dB)	Mag.	Ang.	(dB)	Mag.	Ang.	Mag.	Ang.		
0.1	0.866	-84.2	33.69	48.364	135.7	-37.08	0.014	51.3	0.366	-106.5	35.38	
0.2	0.865	-124.5	30.08	31.913	114.3	-33.98	0.020	35.7	0.451	-138.0	32.03	
0.3	0.868	-144.8	27.22	22.964	102.7	-33.15	0.022	28.6	0.483	-152.3	30.19	
0.4	0.870	-157.3	24.98	17.748	94.9	-32.77	0.023	24.5	0.498	-160.7	28.87	
0.5	0.884	-170.8	21.85	12.369	89.3	-33.56	0.021	22.6	0.572	-174.3	27.70	
0.6	0.886	-176.3	20.30	10.356	85.4	-33.56	0.021	22.3	0.577	-177.5	26.93	
0.7	0.887	179.2	19.01	8.926	82.0	-33.15	0.022	22.1	0.579	179.8	26.08	
0.8	0.887	175.4	17.91	7.862	78.8	-32.77	0.023	22.3	0.579	177.4	25.34	
0.9	0.886	171.9	16.94	7.033	75.8	-32.40	0.024	22.4	0.578	175.2	24.67	
1.0	0.888	168.7	16.05	6.344	72.9	-32.40	0.024	22.6	0.577	173.2	24.22	
1.5	0.886	154.7	12.68	4.307	59.5	-30.75	0.029	22.3	0.570	164.0	21.72	
2.0	0.885	141.7	10.33	3.284	46.5	-29.37	0.034	19.7	0.560	155.1	18.68	
2.5	0.881	128.7	8.57	2.681	33.3	-28.18	0.039	15.0	0.554	146.1	16.18	
3.0	0.868	113.6	7.16	2.280	18.8	-26.94	0.045	7.5	0.549	137.6	14.17	
3.5	0.876	104.5	6.24	2.051	8.3	-26.66	0.046	1.3	0.566	129.1	13.55	
4.0	0.884	95.5	5.21	1.823	-2.2	-26.39	0.048	-4.9	0.584	120.6	12.84	
5.0	0.901	77.3	2.70	1.365	-23.3	-25.88	0.051	-17.3	0.618	103.7	11.06	
6.0	0.917	59.2	-0.84	0.908	-44.3	-25.40	0.054	-29.7	0.653	86.7	8.44	
7.0	0.947	43.4	-3.38	0.678	-63.3	-26.02	0.050	-40.8	0.691	73.8	8.02	
8.0	0.960	31.6	-5.73	0.517	-80.8	-26.74	0.046	-52.8	0.732	60.3	7.39	
9.0	0.941	23.4	-8.27	0.386	-96.1	-28.18	0.039	-64.6	0.774	47.2	4.27	
10.0	0.947	14.1	-10.34	0.304	-111.3	-29.90	0.032	-80.9	0.807	36.1	3.57	
11.0	0.938	3.0	-12.18	0.246	-128.0	-33.15	0.022	-114.7	0.826	26.5	2.13	
12.0	0.914	-3.7	-13.85	0.203	-142.4	-38.42	0.012	-156.1	0.844	16.7	-0.36	
13.0	0.954	-15.0	-15.76	0.163	-162.4	-37.72	0.013	100.7	0.843	7.4	0.47	
14.0	0.948	-19.9	-17.79	0.129	-171.0	-39.17	0.011	49.4	0.849	0.8	-2.37	
15.0	0.937	-21.1	-18.49	0.119	-178.9	-43.10	0.007	72.7	0.876	-4.6	-2.98	
16.0	0.949	-24.6	-18.86	0.114	173.5	-44.44	0.006	78.5	0.873	-8.6	-2.54	
17.0	0.947	-33.0	-17.86	0.128	158.9	-38.42	0.012	119.1	0.881	-13.3	-1.06	
18.0	0.902	-45.1	-17.20	0.138	141.5	-33.98	0.020	116.4	0.856	-21.4	-3.85	

Freq GHz	Fmin dB	Gamma Opt		Rn/50	Ga dB
		Mag	Ang		
0.5	0.61	0.434	175.5	0.14	19.42
1.0	0.75	0.490	-170.4	0.09	17.66
2.0	1.03	0.595	-142.6	0.08	15.68
3.0	1.30	0.689	-116.0	0.11	12.74
4.0	1.56	0.763	-93.9	0.19	11.11
5.0	1.86	0.837	-70.1	0.55	9.71
6.0	2.14	0.887	-52.4	0.70	8.56
7.0	2.42	0.918	-39.2	0.95	7.89
8.0	2.70	0.929	-31.4	1.34	6.79

**Notes:**

1.  $F_{min}$  values at 2 GHz and higher are based on measurements while the  $F_{min}$  below 2 GHz have been extrapolated. The  $F_{min}$  values are based on a set of 16 noise figure measurements made at 16 different impedances using an ATN NP5 test system. From these measurements a true  $F_{min}$  is calculated. Refer to the noise parameter application section for more information.
2. S and noise parameters are measured on a microstrip line made on 0.025 inch thick alumina carrier. The input reference plane is at the end of the gate lead. The output reference plane is at the end of the drain lead.



**Figure 53. MSG/MAG &  $|S21|^2$  vs. Frequency at 4.0V/200 mA.**

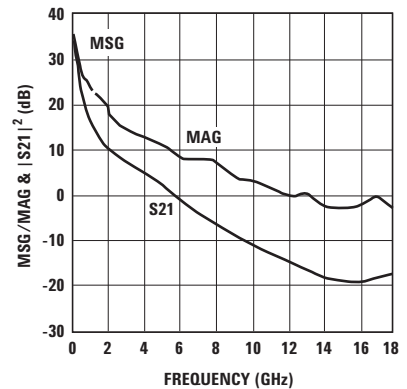
**ATF-52189 Typical Scattering and Noise Parameters at 25°C,  $V_{DS} = 3.0V$ ,  $I_{DS} = 200$  mA**

Freq (GHz)	S11			S21			S12		S22		MSG/MAG dB
	Mag.	Ang.	(dB)	Mag.	Ang.	(dB)	Mag.	Ang.	Mag.	Ang.	
0.1	0.880	-81.4	33.44	46.976	136.0	-35.92	0.016	53.2	0.374	-106.9	34.68
0.2	0.882	-121.9	29.97	31.521	115.1	-33.15	0.022	35.2	0.488	-138.1	31.56
0.3	0.885	-143.0	27.17	22.842	103.3	-32.40	0.024	26.7	0.529	-152.9	29.79
0.4	0.886	-156.1	24.96	17.691	95.3	-32.04	0.025	22.1	0.545	-161.6	28.50
0.5	0.893	-170.1	21.77	12.257	89.6	-33.15	0.022	20.0	0.614	-174.8	27.46
0.6	0.894	-175.8	20.22	10.259	85.7	-32.77	0.023	19.6	0.618	-178.2	26.49
0.7	0.893	179.6	18.93	8.842	82.3	-32.77	0.023	19.7	0.619	179.1	25.85
0.8	0.892	175.6	17.83	7.786	79.1	-32.40	0.024	19.9	0.618	176.6	25.11
0.9	0.891	172.1	16.86	6.967	76.1	-32.40	0.024	20.2	0.617	174.4	24.63
1.0	0.893	168.8	15.96	6.281	73.3	-32.04	0.025	20.5	0.616	172.3	24.00
1.5	0.889	154.6	12.60	4.265	60.0	-30.75	0.029	21.2	0.608	162.8	21.68
2.0	0.887	141.6	10.26	3.258	47.2	-29.37	0.034	19.3	0.597	153.7	18.87
2.5	0.882	128.6	8.50	2.660	34.2	-27.96	0.040	14.6	0.591	144.5	16.25
3.0	0.869	113.5	7.10	2.264	19.8	-26.74	0.046	6.9	0.585	135.8	14.22
3.5	0.877	104.4	6.18	2.037	9.5	-26.50	0.047	0.6	0.600	127.3	13.59
4.0	0.885	95.4	5.16	1.811	-0.9	-26.27	0.049	-5.7	0.616	118.8	12.87
5.0	0.901	77.2	2.66	1.358	-21.6	-25.82	0.051	-18.4	0.647	101.7	11.07
6.0	0.916	59.1	-0.87	0.904	-42.2	-25.39	0.054	-31.0	0.678	84.7	8.45
7.0	0.947	43.2	-3.36	0.679	-60.8	-26.02	0.050	-42.3	0.711	71.9	8.06
8.0	0.960	31.5	-5.68	0.520	-77.8	-26.74	0.046	-54.2	0.747	58.6	7.42
9.0	0.941	23.2	-8.18	0.390	-92.9	-28.18	0.039	-66.1	0.785	45.7	4.41
10.0	0.945	13.9	-10.20	0.309	-107.4	-29.90	0.032	-82.6	0.813	34.8	3.57
11.0	0.937	2.9	-12.04	0.250	-124.1	-33.15	0.022	-116.2	0.830	25.3	2.23
12.0	0.914	-4.0	-13.60	0.209	-137.8	-38.42	0.012	-158.8	0.845	15.6	-0.08
13.0	0.953	-15.3	-15.55	0.167	-157.2	-37.72	0.013	100.1	0.843	6.5	0.64
14.0	0.947	-20.2	-17.46	0.134	-165.2	-39.17	0.011	50.2	0.848	-0.1	-2.10
15.0	0.939	-21.6	-18.20	0.123	-173.2	-43.10	0.007	73.3	0.874	-5.3	-2.59
16.0	0.949	-25.0	-18.49	0.119	178.6	-44.44	0.006	81.7	0.870	-9.2	-2.23
17.0	0.948	-33.4	-17.39	0.135	164.0	-37.72	0.013	121.3	0.876	-14.1	-0.58
18.0	0.902	-45.7	-16.71	0.146	147.2	-33.98	0.020	117.2	0.849	-22.1	-3.52

Freq GHz	Fmin dB	Gamma Opt		Rn/50	Ga dB
		Mag	Ang		
0.5	0.75	0.341	174.7	0.11	21.18
1.0	0.84	0.427	-171.1	0.08	19.42
2.0	1.00	0.573	-143.2	0.06	17.13
3.0	1.17	0.688	-116.6	0.11	14.59
4.0	1.32	0.769	-94.3	0.20	10.99
5.0	1.50	0.847	-70.4	0.45	9.83
6.0	1.67	0.903	-52.6	0.66	8.48
7.0	1.83	0.951	-39.3	0.85	7.61
8.0	2.00	0.996	-31.6	1.10	4.30

**Notes:**

1.  $F_{min}$  values at 2 GHz and higher are based on measurements while the  $F_{min}$  below 2 GHz have been extrapolated. The  $F_{min}$  values are based on a set of 16 noise figure measurements made at 16 different impedances using an ATN NP5 test system. From these measurements a true  $F_{min}$  is calculated. Refer to the noise parameter application section for more information.
2. S and noise parameters are measured on a microstrip line made on 0.025 inch thick alumina carrier. The input reference plane is at the end of the gate lead. The output reference plane is at the end of the drain lead.



**Figure 54. MSG/MAG &  $|S21|^2$  vs. Frequency at 3.0V/200 mA.**

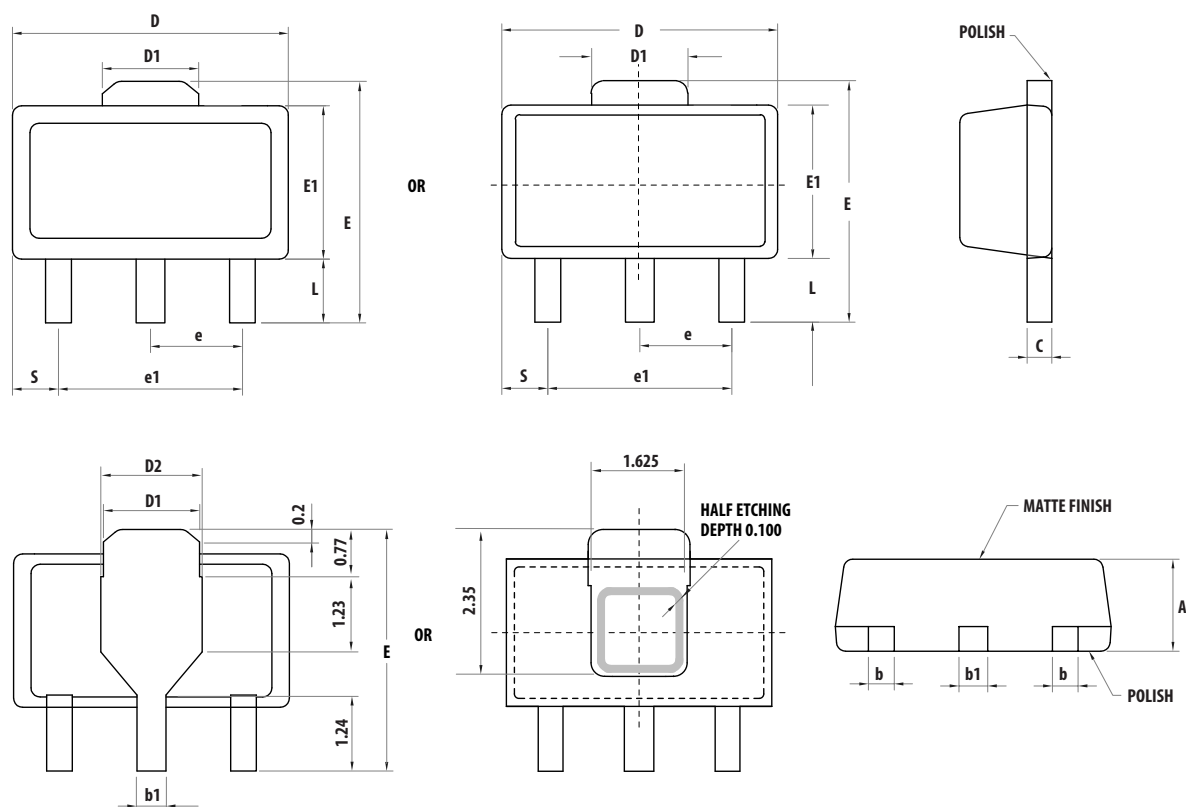
## Device Models, PCB Layout and Stencil Device

Refer to Avago's Web Site: [www.avagotech.com/view/rf](http://www.avagotech.com/view/rf)

### Part Number Ordering Information

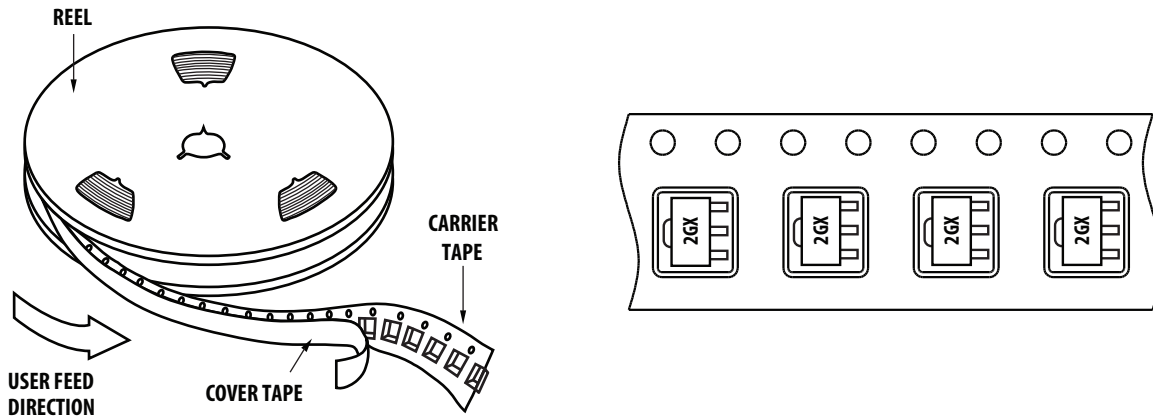
Part Number	No of devices	Container
ATF-52189-BLKG	100	7" Tape/Reel
ATF-52189-TR1G	3000	13" Tape/Reel

### SOT89 Package Dimensions

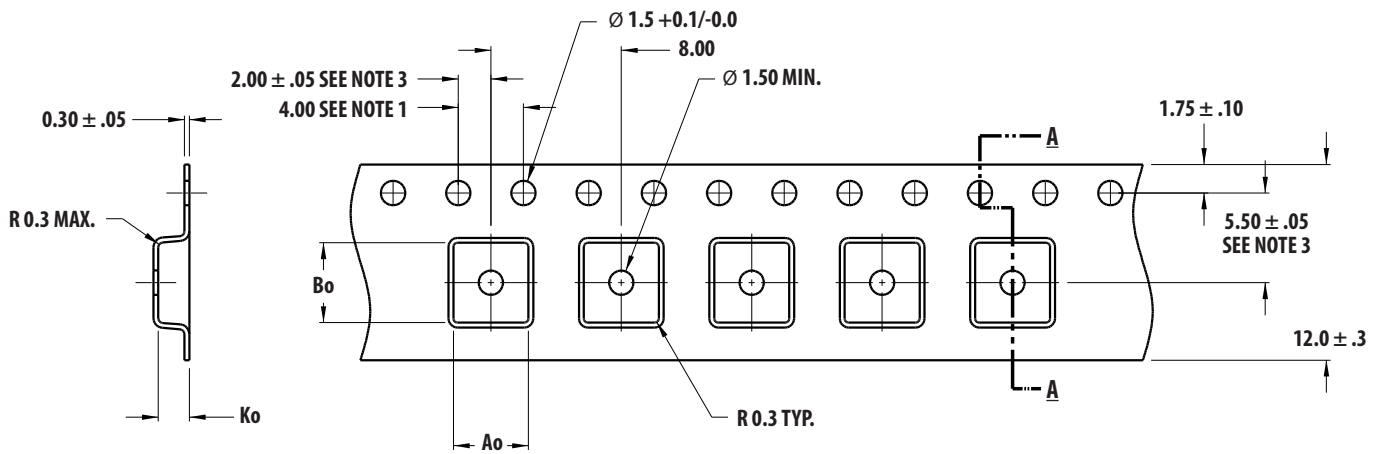


Symbols	Dimensions in mm			Dimensions in inches		
	Minimum	Nominal	Maximum	Minimum	Nominal	Maximum
A	1.40	1.50	1.60	0.055	0.059	0.063
L	0.89	1.04	1.20	0.0350	0.041	0.047
b	0.36	0.42	0.48	0.014	0.016	0.018
b1	0.41	0.47	0.53	0.016	0.018	0.030
C	0.38	0.40	0.43	0.014	0.015	0.017
D	4.40	4.50	4.60	0.173	0.177	0.181
D1	1.40	1.60	1.75	0.055	0.062	0.069
D2	1.45	1.65	1.80	0.055	0.062	0.069
E	3.94	-	4.25	0.155	-	0.167
E1	2.40	2.50	2.60	0.094	0.098	0.102
e1	2.90	3.00	3.10	0.114	0.118	0.122
S	0.65	0.75	0.85	0.026	0.030	0.034
e	1.40	1.50	1.60	0.054	0.059	0.063

## Device Orientation



## Tape Dimensions



### SECTION A - A

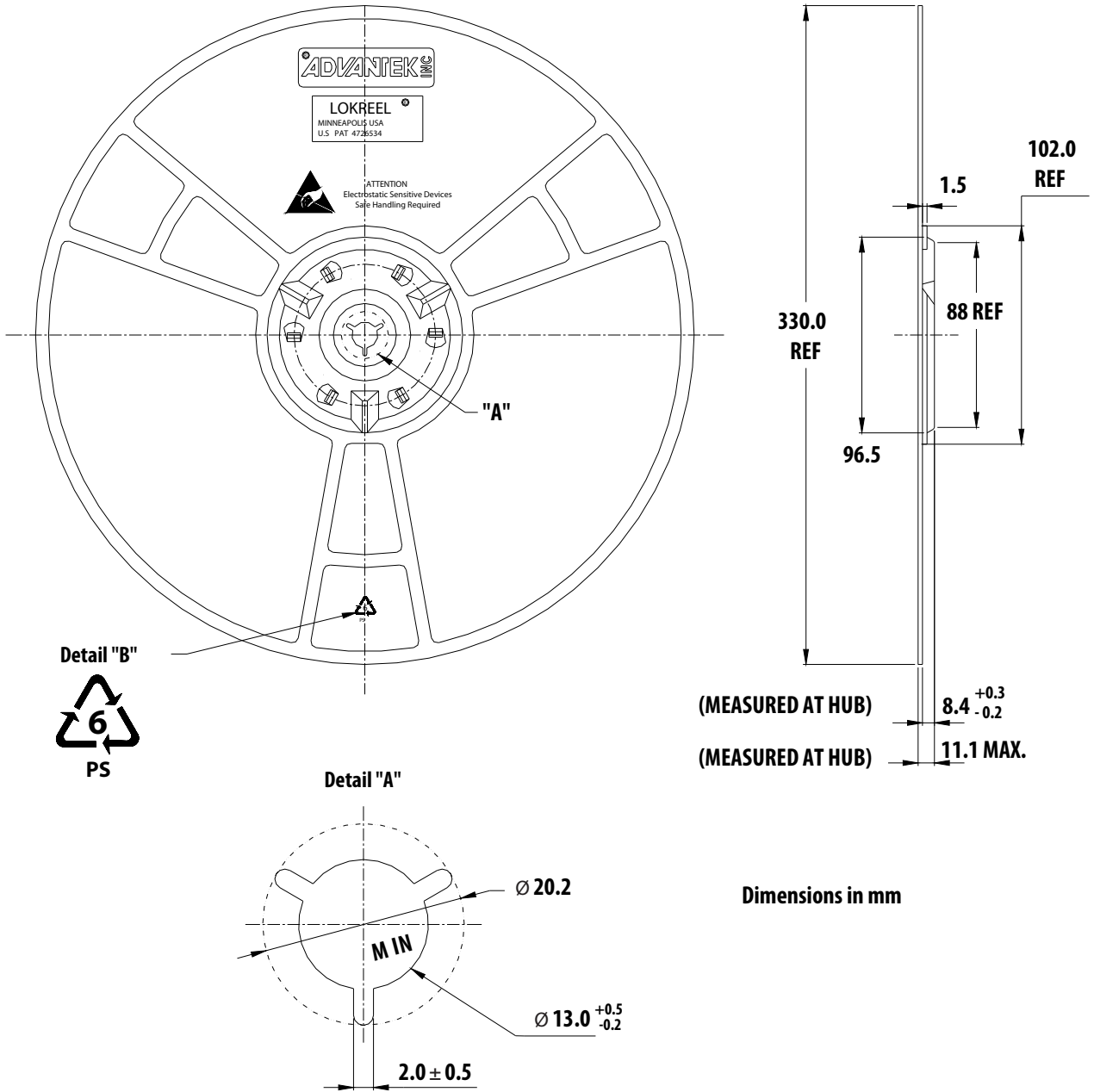
Ao = 4.60  
Bo = 4.90  
Ko = 1.90

### DIMENSIONS IN MM

#### NOTES:

1. 10 SPROCKET HOLE PITCH CUMULATIVE TOLERANCE  $\pm 0.2$
2. CAMBER IN COMPLIANCE WITH EIA 481
3. POCKET POSITION RELATIVE TO SPROCKET HOLE MEASURED AS TRUE POSITION OF POCKET, NOT POCKET HOLE

# Reel Dimensions – 13" Reel



Dimensions in mm

For product information and a complete list of distributors, please go to our web site: [www.avagotech.com](http://www.avagotech.com)

Avago, Avago Technologies, and the A logo are trademarks of Avago Technologies in the United States and other countries. Data subject to change. Copyright © 2005-2013 Avago Technologies. All rights reserved. AV02-0050EN - November 11, 2013



## Looking for pricing, stock, or lifecycle information?

Click below to explore more details on WIN SOURCE:

 [View ATF-52189-BLK on WIN SOURCE](#)

 [Broadcom Limited](#) Information

## Optimize Your Supply Chain with WIN SOURCE Solutions

-  Global Sourcing Solution
-  Obsolete Management
-  Cost Control Management
-  Shortage Management
-  Alternative Solution
-  Excess Inventory Management