



Is Now Part of



ON Semiconductor®

To learn more about ON Semiconductor, please visit our website at
www.onsemi.com

Please note: As part of the Fairchild Semiconductor integration, some of the Fairchild orderable part numbers will need to change in order to meet ON Semiconductor's system requirements. Since the ON Semiconductor product management systems do not have the ability to manage part nomenclature that utilizes an underscore (_), the underscore (_) in the Fairchild part numbers will be changed to a dash (-). This document may contain device numbers with an underscore (_). Please check the ON Semiconductor website to verify the updated device numbers. The most current and up-to-date ordering information can be found at www.onsemi.com. Please email any questions regarding the system integration to Fairchild_questions@onsemi.com.

ON Semiconductor and the ON Semiconductor logo are trademarks of Semiconductor Components Industries, LLC dba ON Semiconductor or its subsidiaries in the United States and/or other countries. ON Semiconductor owns the rights to a number of patents, trademarks, copyrights, trade secrets, and other intellectual property. A listing of ON Semiconductor's product/patent coverage may be accessed at www.onsemi.com/site/pdf/Patent-Marking.pdf. ON Semiconductor reserves the right to make changes without further notice to any products herein. ON Semiconductor makes no warranty, representation or guarantee regarding the suitability of its products for any particular purpose, nor does ON Semiconductor assume any liability arising out of the application or use of any product or circuit, and specifically disclaims any and all liability, including without limitation special, consequential or incidental damages. Buyer is responsible for its products and applications using ON Semiconductor products, including compliance with all laws, regulations and safety requirements or standards, regardless of any support or applications information provided by ON Semiconductor. "Typical" parameters which may be provided in ON Semiconductor data sheets and/or specifications can and do vary in different applications and actual performance may vary over time. All operating parameters, including "Typicals" must be validated for each customer application by customer's technical experts. ON Semiconductor does not convey any license under its patent rights nor the rights of others. ON Semiconductor products are not designed, intended, or authorized for use as a critical component in life support systems or any FDA Class 3 medical devices or medical devices with a same or similar classification in a foreign jurisdiction or any devices intended for implantation in the human body. Should Buyer purchase or use ON Semiconductor products for any such unintended or unauthorized application, Buyer shall indemnify and hold ON Semiconductor and its officers, employees, subsidiaries, affiliates, and distributors harmless against all claims, costs, damages, and expenses, and reasonable attorney fees arising out of, directly or indirectly, any claim of personal injury or death associated with such unintended or unauthorized use, even if such claim alleges that ON Semiconductor was negligent regarding the design or manufacture of the part. ON Semiconductor is an Equal Opportunity/Affirmative Action Employer. This literature is subject to all applicable copyright laws and is not for resale in any manner.



April 2015

4N25M, 4N26M, 4N27M, 4N28M, 4N35M, 4N36M, 4N37M 6-Pin General Purpose Phototransistor Optocouplers

Features

- Minimum Current Transfer Ratio at $I_F = 10 \text{ mA}$, $V_{CE} = 10 \text{ V}$:
 - 10% for 4N27M and 4N28M
 - 20% for 4N25M and 4N26M
 - 100% for 4N35M, 4N36M and 4N37M
- Safety and Regulatory Approvals:
 - UL1577, 4,170 $V_{AC_{RMS}}$ for 1 Minute
 - DIN-EN/IEC60747-5-5, 850 V Peak Working Insulation Voltage

Applications

- Power Supply Regulators
- Digital Logic Inputs
- Microprocessor Inputs

Description

The general purpose optocouplers consist of a gallium arsenide infrared emitting diode driving a silicon phototransistor in a standard plastic six-pin dual-in-line package.

Schematic



- PIN 1. ANODE
2. CATHODE
3. NO CONNECTION
4. EMITTER
5. COLLECTOR
6. BASE

Figure 1. Schematic

Package Outlines



Figure 2. Package Outlines

4N25M, 4N26M, 4N27M, 4N28M, 4N35M, 4N36M, 4N37M — 6-Pin General Purpose Phototransistor Optocouplers

Safety and Insulation Ratings

As per DIN EN/IEC 60747-5-5, this optocoupler is suitable for “safe electrical insulation” only within the safety limit data. Compliance with the safety ratings shall be ensured by means of protective circuits.

| Parameter | | Characteristics |
|---|------------------------|-----------------|
| Installation Classifications per DIN VDE 0110/1.89 Table 1, For Rated Mains Voltage | < 150 V _{RMS} | I–IV |
| | < 300 V _{RMS} | I–IV |
| Climatic Classification | | 55/100/21 |
| Pollution Degree (DIN VDE 0110/1.89) | | 2 |
| Comparative Tracking Index | | 175 |

| Symbol | Parameter | Value | Unit |
|-----------------------|--|-------------------|-------------------|
| V _{PR} | Input-to-Output Test Voltage, Method A, V _{IORM} × 1.6 = V _{PR} , Type and Sample Test with t _m = 10 s, Partial Discharge < 5 pC | 1360 | V _{peak} |
| | Input-to-Output Test Voltage, Method B, V _{IORM} × 1.875 = V _{PR} , 100% Production Test with t _m = 1 s, Partial Discharge < 5 pC | 1594 | V _{peak} |
| V _{IORM} | Maximum Working Insulation Voltage | 850 | V _{peak} |
| V _{IOTM} | Highest Allowable Over-Voltage | 6000 | V _{peak} |
| | External Creepage | ≥ 7 | mm |
| | External Clearance | ≥ 7 | mm |
| | External Clearance (for Option TV, 0.4" Lead Spacing) | ≥ 10 | mm |
| DTI | Distance Through Insulation (Insulation Thickness) | ≥ 0.5 | mm |
| T _S | Case Temperature ⁽¹⁾ | 175 | °C |
| I _{S,INPUT} | Input Current ⁽¹⁾ | 350 | mA |
| P _{S,OUTPUT} | Output Power ⁽¹⁾ | 800 | mW |
| R _{IO} | Insulation Resistance at T _S , V _{IO} = 500 V ⁽¹⁾ | > 10 ⁹ | Ω |

Note:

1. Safety limit values – maximum values allowed in the event of a failure.

Absolute Maximum Ratings

Stresses exceeding the absolute maximum ratings may damage the device. The device may not function or be operable above the recommended operating conditions and stressing the parts to these levels is not recommended. In addition, extended exposure to stresses above the recommended operating conditions may affect device reliability. The absolute maximum ratings are stress ratings only. $T_A = 25^\circ\text{C}$ unless otherwise specified.

| Symbol | Parameter | Value | Unit |
|---------------------|--|--------------------|----------------------|
| TOTAL DEVICE | | | |
| T_{STG} | Storage Temperature | -40 to +125 | $^\circ\text{C}$ |
| T_{OPR} | Operating Temperature | -40 to +100 | $^\circ\text{C}$ |
| T_J | Junction Temperature | -40 to +125 | $^\circ\text{C}$ |
| T_{SOL} | Lead Solder Temperature | 260 for 10 seconds | $^\circ\text{C}$ |
| P_D | Total Device Power Dissipation @ $T_A = 25^\circ\text{C}$ | 270 | mW |
| | Derate Above 25°C | 2.94 | mW/ $^\circ\text{C}$ |
| EMITTER | | | |
| I_F | DC/Average Forward Input Current | 60 | mA |
| V_R | Reverse Input Voltage | 6 | V |
| $I_F(\text{pk})$ | Forward Current – Peak (300 μs , 2% Duty Cycle) | 3 | A |
| P_D | LED Power Dissipation @ $T_A = 25^\circ\text{C}$ | 120 | mW |
| | Derate Above 25°C | 1.41 | mW/ $^\circ\text{C}$ |
| DETECTOR | | | |
| V_{CEO} | Collector-to-Emitter Voltage | 30 | V |
| V_{CBO} | Collector-to-Base Voltage | 70 | V |
| V_{ECO} | Emitter-to-Collector Voltage | 7 | V |
| P_D | Detector Power Dissipation @ $T_A = 25^\circ\text{C}$ | 150 | mW |
| | Derate Above 25°C | 1.76 | mW/ $^\circ\text{C}$ |

Electrical Characteristics

TA = 25°C unless otherwise specified.

Individual Component Characteristics

| Symbol | Parameter | Test Conditions | Min. | Typ. | Max. | Unit |
|-------------------|--|---|------|-------|------|------|
| EMITTER | | | | | | |
| V _F | Input Forward Voltage | I _F = 10 mA | | 1.18 | 1.50 | V |
| I _R | Reverse Leakage Current | V _R = 6.0 V | | 0.001 | 10 | μA |
| DETECTOR | | | | | | |
| BV _{CEO} | Collector-to-Emitter Breakdown Voltage | I _C = 1.0 mA, I _F = 0 | 30 | 100 | | V |
| BV _{CBO} | Collector-to-Base Breakdown Voltage | I _C = 100 μA, I _F = 0 | 70 | 120 | | V |
| BV _{ECO} | Emitter-to-Collector Breakdown Voltage | I _E = 100 μA, I _F = 0 | 7 | 10 | | V |
| I _{CEO} | Collector-to-Emitter Dark Current | V _{CE} = 10 V, I _F = 0 | | 1 | 50 | nA |
| I _{CBO} | Collector-to-Base Dark Current | V _{CB} = 10 V | | | 20 | nA |
| C _{CE} | Capacitance | V _{CE} = 0 V, f = 1 MHz | | 8 | | pF |

Transfer Characteristics

| Symbol | Parameter | Test Conditions | Device | Min. | Typ. | Max. | Unit |
|---|--|--|----------------------------|------|------|------|------|
| DC CHARACTERISTICS | | | | | | | |
| CTR | Current Transfer Ratio, Collector-to-Emitter | I _F = 10 mA, V _{CE} = 10 V | 4N35M, 4N36M, 4N37M | 100 | | | % |
| | | | 4N25M, 4N26M | 20 | | | % |
| | | | 4N27M, 4N28M | 10 | | | % |
| | | I _F = 10 mA, V _{CE} = 10 V, T _A = -55°C | 4N35M, 4N36M, 4N37M | 40 | | | % |
| I _F = 10 mA, V _{CE} = 10 V, T _A = +100°C | 4N35M, 4N36M, 4N37M | 40 | | | % | | |
| V _{CE (SAT)} | Collector-to-Emitter Saturation Voltage | I _C = 2 mA, I _F = 50 mA | 4N25M, 4N26M, 4N27M, 4N28M | | | 0.5 | V |
| | | I _C = 0.5 mA, I _F = 10 mA | 4N35M, 4N36M, 4N37M | | | 0.3 | V |
| AC CHARACTERISTICS | | | | | | | |
| T _{ON} | Non-Saturated Turn-on Time | I _F = 10 mA, V _{CC} = 10 V, R _L = 100 Ω (Figure 13) | 4N25M, 4N26M, 4N27M, 4N28M | | 2 | | μs |
| | | I _C = 2 mA, V _{CC} = 10 V, R _L = 100 Ω (Figure 13) | 4N35M, 4N36M, 4N37M | | 2 | 10 | μs |
| T _{OFF} | Turn-off Time | I _F = 10 mA, V _{CC} = 10 V, R _L = 100 Ω (Figure 13) | 4N25M, 4N26M, 4N27M, 4N28M | | 2 | | μs |
| | | I _C = 2 mA, V _{CC} = 10 V, R _L = 100 Ω (Figure 13) | 4N35M, 4N36M, 4N37M | | 2 | 10 | μs |

Isolation Characteristics

| Symbol | Characteristic | Test Conditions | Min. | Typ. | Max. | Unit |
|------------------|--------------------------------|--|------------------|------|------|---------------------|
| V _{ISO} | Input-Output Isolation Voltage | t = 1 Minute | 4170 | | | V _{AC RMS} |
| C _{ISO} | Isolation Capacitance | V _{I-O} = 0 V, f = 1 MHz | | 0.2 | | pF |
| R _{ISO} | Isolation Resistance | V _{I-O} = ±500 VDC, T _A = 25°C | 10 ¹¹ | | | Ω |

Typical Performance Curves



Figure 3. LED Forward Voltage vs. Forward Current



Figure 4. Normalized CTR vs. Forward Current

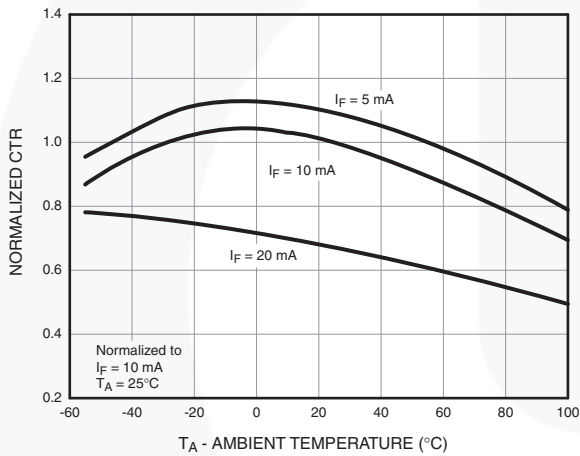

Figure 5. Normalized CTR vs. Ambient Temperature

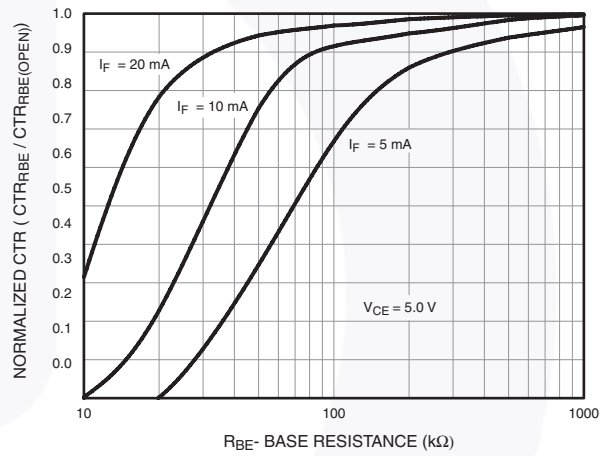

Figure 6. CTR vs. R_{BE} (Unsaturated)

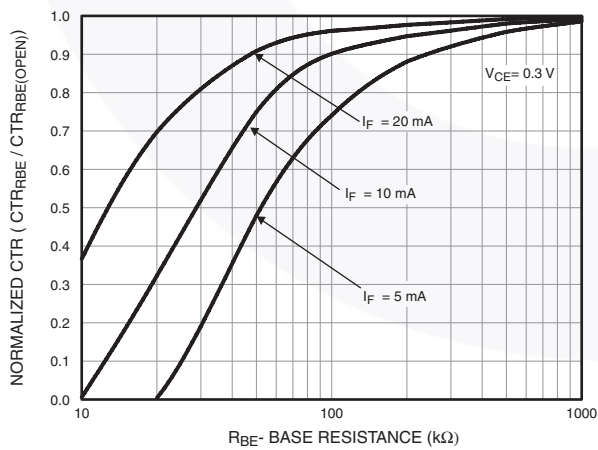

Figure 7. CTR vs. R_{BE} (Saturated)

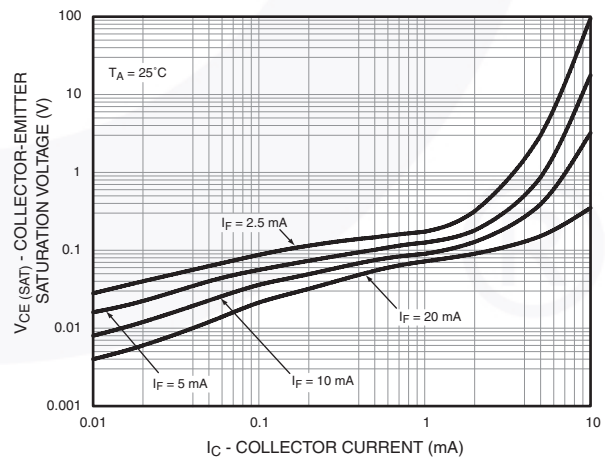

Figure 8. Collector-Emitter Saturation Voltage vs. Collector Current

Typical Performance Curves (Continued)



Figure 9. Switching Speed vs. Load Resistor

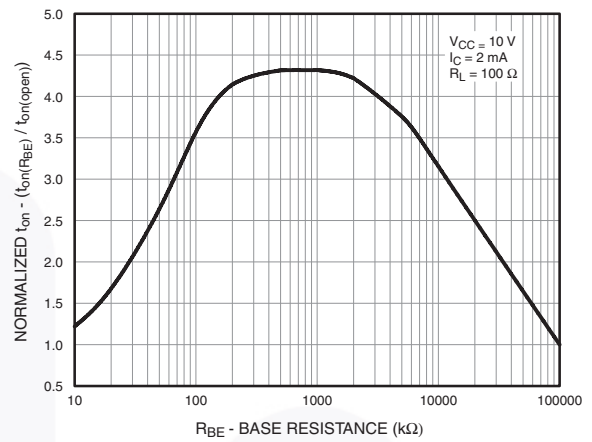

Figure 10. Normalized t_{on} vs. R_{BE}

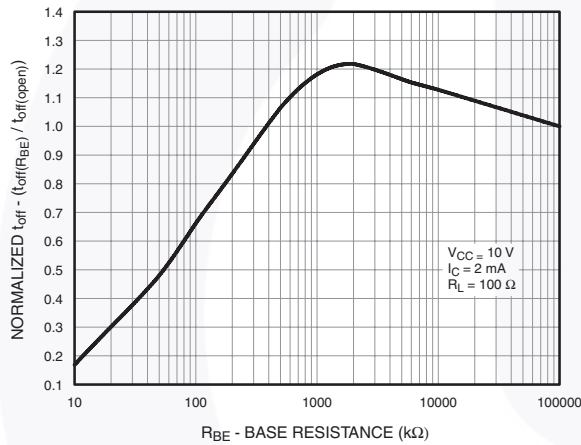

Figure 11. Normalized t_{off} vs. R_{BE}



Figure 12. Dark Current vs. Ambient Temperature

Switching Time Test Circuit and Waveforms



Figure 13. Switching Time Test Circuit and Waveforms

Reflow Profile



Figure 14. Reflow Profile

Ordering Information

| Part Number | Package | Packing Method |
|-------------|--|----------------------------|
| 4N25M | DIP 6-Pin | Tube (50 Units) |
| 4N25SM | SMT 6-Pin (Lead Bend) | Tube (50 Units) |
| 4N25SR2M | SMT 6-Pin (Lead Bend) | Tape and Reel (1000 Units) |
| 4N25VM | DIP 6-Pin, DIN EN/IEC60747-5-5 Option | Tube (50 Units) |
| 4N25SVM | SMT 6-Pin (Lead Bend), DIN EN/IEC60747-5-5 Option | Tube (50 Units) |
| 4N25SR2VM | SMT 6-Pin (Lead Bend), DIN EN/IEC60747-5-5 Option | Tape and Reel (1000 Units) |
| 4N25TVM | DIP 6-Pin, 0.4" Lead Spacing, DIN EN/IEC60747-5-5 Option | Tube (50 Units) |

Note:

2. The product orderable part number system listed in this table also applies to the 4N26M, 4N27M, 4N28M, 4N35M, 4N36M, and 4N37M devices.

Marking Information



Figure 15. Top Mark

Table 1. Top Mark Definitions

| | |
|---|---|
| 1 | Fairchild Logo |
| 2 | Device Number |
| 3 | DIN EN/IEC60747-5-5 Option (only appears on component ordered with this option) |
| 4 | One-Digit Year Code, e.g., "5" |
| 5 | Digit Work Week, Ranging from "01" to "53" |
| 6 | Assembly Package Code |

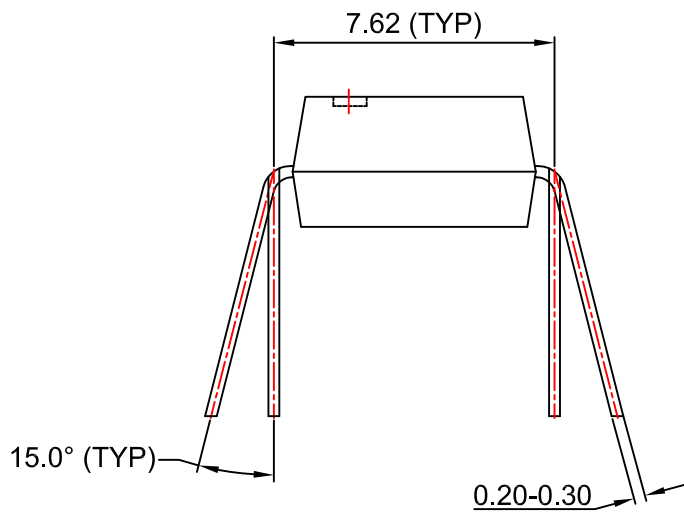

NOTES:

- A) NO STANDARD APPLIES TO THIS PACKAGE.
- B) ALL DIMENSIONS ARE IN MILLIMETERS.
- C) DIMENSIONS ARE EXCLUSIVE OF BURRS, MOLD FLASH, AND TIE BAR EXTRUSION
- D) DRAWING FILENAME AND REVISION: MKT-N06BREV4.





LAND PATTERN RECOMMENDATION

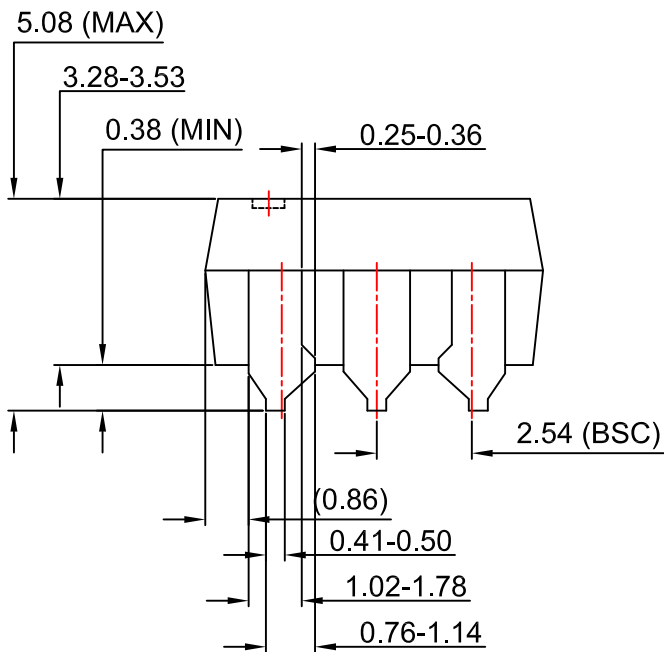

NOTES:

- A) NO STANDARD APPLIES TO THIS PACKAGE.
- B) ALL DIMENSIONS ARE IN MILLIMETERS.
- C) DIMENSIONS ARE EXCLUSIVE OF BURRS, MOLD FLASH, AND TIE BAR EXTRUSION
- D) DRAWING FILENAME AND REVISION : MKT-N06CREV4.





NOTES:

- A) NO STANDARD APPLIES TO THIS PACKAGE.
- B) ALL DIMENSIONS ARE IN MILLIMETERS.
- C) DIMENSIONS ARE EXCLUSIVE OF BURRS, MOLD FLASH, AND TIE BAR EXTRUSION
- D) DRAWING FILENAME AND REVISION: MKT-N06Drev4



ON Semiconductor and  are trademarks of Semiconductor Components Industries, LLC dba ON Semiconductor or its subsidiaries in the United States and/or other countries. ON Semiconductor owns the rights to a number of patents, trademarks, copyrights, trade secrets, and other intellectual property. A listing of ON Semiconductor's product/patent coverage may be accessed at www.onsemi.com/site/pdf/Patent-Marking.pdf. ON Semiconductor reserves the right to make changes without further notice to any products herein. ON Semiconductor makes no warranty, representation or guarantee regarding the suitability of its products for any particular purpose, nor does ON Semiconductor assume any liability arising out of the application or use of any product or circuit, and specifically disclaims any and all liability, including without limitation special, consequential or incidental damages. Buyer is responsible for its products and applications using ON Semiconductor products, including compliance with all laws, regulations and safety requirements or standards, regardless of any support or applications information provided by ON Semiconductor. "Typical" parameters which may be provided in ON Semiconductor data sheets and/or specifications can and do vary in different applications and actual performance may vary over time. All operating parameters, including "Typicals" must be validated for each customer application by customer's technical experts. ON Semiconductor does not convey any license under its patent rights nor the rights of others. ON Semiconductor products are not designed, intended, or authorized for use as a critical component in life support systems or any FDA Class 3 medical devices or medical devices with a same or similar classification in a foreign jurisdiction or any devices intended for implantation in the human body. Should Buyer purchase or use ON Semiconductor products for any such unintended or unauthorized application, Buyer shall indemnify and hold ON Semiconductor and its officers, employees, subsidiaries, affiliates, and distributors harmless against all claims, costs, damages, and expenses, and reasonable attorney fees arising out of, directly or indirectly, any claim of personal injury or death associated with such unintended or unauthorized use, even if such claim alleges that ON Semiconductor was negligent regarding the design or manufacture of the part. ON Semiconductor is an Equal Opportunity/Affirmative Action Employer. This literature is subject to all applicable copyright laws and is not for resale in any manner.

PUBLICATION ORDERING INFORMATION

LITERATURE FULFILLMENT:

Literature Distribution Center for ON Semiconductor
19521 E. 32nd Pkwy, Aurora, Colorado 80011 USA
Phone: 303-675-2175 or 800-344-3860 Toll Free USA/Canada
Fax: 303-675-2176 or 800-344-3867 Toll Free USA/Canada
Email: orderlit@onsemi.com

N. American Technical Support: 800-282-9855 Toll Free
USA/Canada
Europe, Middle East and Africa Technical Support:
Phone: 421 33 790 2910
Japan Customer Focus Center
Phone: 81-3-5817-1050

ON Semiconductor Website: www.onsemi.com
Order Literature: <http://www.onsemi.com/orderlit>
For additional information, please contact your local
Sales Representative

Looking for pricing, stock, or lifecycle information?

Click below to explore more details on WIN SOURCE:

- ⊖ [View H11A1SR2VM on WIN SOURCE](#)
- ⊖ [Fairchild/ON Semiconductor Information](#)

Optimize Your Supply Chain with WIN SOURCE Solutions

- ✓ Global Sourcing Solution
- ✓ Obsolete Management
- ✓ Cost Control Management
- ✓ Shortage Management
- ✓ Alternative Solution
- ✓ Excess Inventory Management