



**THE DATASHEET OF
IRFH5406TRPBF**



HEXFET® Power MOSFET

| | | |
|--|-------------|-----------|
| V_{DS} | 60 | V |
| $R_{DS(on) \max}$ (@ $V_{GS} = 10V$) | 14.4 | mΩ |
| Q_g (typical) | 21 | nC |
| R_G (typical) | 1.1 | Ω |
| I_D (@ $T_{c(Bottom)} = 25^\circ C$) | 40 | A |

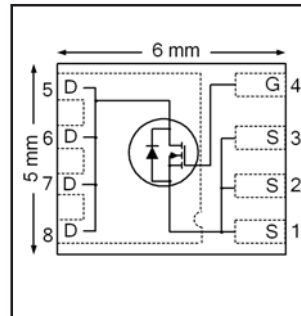

Applications

- Secondary Side Synchronous Rectification
- Inverters for DC Motors
- DC-DC Brick Applications
- Boost Converters

Features and Benefits

Features

| |
|--|
| Low $R_{DS(on)}$ (< 14.4 mΩ) |
| Low Thermal Resistance to PCB (< 2.7°C/W) |
| 100% R_g tested |
| Low Profile (<0.9 mm) |
| Industry-Standard Pinout |
| Compatible with Existing Surface Mount Techniques |
| RoHS Compliant Containing no Lead, no Bromide and no Halogen |
| MSL1, Industrial Qualification |

results in
⇒

Benefits

| |
|------------------------------------|
| Lower Conduction Losses |
| Enables better thermal dissipation |
| Increased Reliability |
| Increased Power Density |
| Multi-Vendor Compatibility |
| Easier Manufacturing |
| Environmentally Friendlier |
| Increased Reliability |

| Orderable part number | Package Type | Standard Pack | | Note |
|-----------------------|----------------|---------------|----------|------------------|
| | | Form | Quantity | |
| IRFH5406TRPbF | PQFN 5mm x 6mm | Tape and Reel | 4000 | |
| IRFH5406TR2PbF | PQFN 5mm x 6mm | Tape and Reel | 400 | EOL notice # 259 |

Absolute Maximum Ratings

| | Parameter | Max. | Units |
|-------------------------------------|---|--------------|-------|
| V_{DS} | Drain-to-Source Voltage | 60 | V |
| V_{GS} | Gate-to-Source Voltage | ± 20 | |
| $I_D @ T_A = 25^\circ C$ | Continuous Drain Current, $V_{GS} @ 10V$ | 11 | A |
| $I_D @ T_A = 70^\circ C$ | Continuous Drain Current, $V_{GS} @ 10V$ | 9 | |
| $I_D @ T_{C(Bottom)} = 25^\circ C$ | Continuous Drain Current, $V_{GS} @ 10V$ | 40 | |
| $I_D @ T_{C(Bottom)} = 100^\circ C$ | Continuous Drain Current, $V_{GS} @ 10V$ | 25 | |
| I_{DM} | Pulsed Drain Current ① | 160 | |
| $P_D @ T_A = 25^\circ C$ | Power Dissipation ② | 3.6 | W |
| $P_D @ T_{C(Bottom)} = 25^\circ C$ | Power Dissipation ② | 46 | |
| | Linear Derating Factor ③ | 0.029 | W/°C |
| T_J T_{STG} | Operating Junction and Storage Temperature Range | -55 to + 150 | °C |

Notes ① through ⑤ are on page 9

Static @ T_J = 25°C (unless otherwise specified)

| | Parameter | Min. | Typ. | Max. | Units | Conditions |
|-------------------------------------|---|------|------|------|-------|---|
| B _V DSS | Drain-to-Source Breakdown Voltage | 60 | — | — | V | V _{GS} = 0V, I _D = 250μA |
| ΔB _V DSS/ΔT _J | Breakdown Voltage Temp. Coefficient | — | 0.07 | — | V/°C | Reference to 25°C, I _D = 1.0mA |
| R _{DS(on)} | Static Drain-to-Source On-Resistance | — | 11.4 | 14.4 | mΩ | V _{GS} = 10V, I _D = 24A ③ |
| V _{GS(th)} | Gate Threshold Voltage | 2.0 | — | 4.0 | V | V _{DS} = V _{GS} , I _D = 50μA |
| ΔV _{GS(th)} | Gate Threshold Voltage Coefficient | — | -8.6 | — | mV/°C | |
| I _{DSS} | Drain-to-Source Leakage Current | — | — | 20 | μA | V _{DS} = 60V, V _{GS} = 0V |
| | | — | — | 250 | | V _{DS} = 60V, V _{GS} = 0V, T _J = 125°C |
| I _{GSS} | Gate-to-Source Forward Leakage | — | — | 100 | nA | V _{GS} = 20V |
| | Gate-to-Source Reverse Leakage | — | — | -100 | | V _{GS} = -20V |
| g _{fs} | Forward Transconductance | 27 | — | — | S | V _{DS} = 25V, I _D = 24A |
| Q _g | Total Gate Charge | — | 21 | 32 | nC | V _{DS} = 30V V _{GS} = 10V I _D = 24A |
| Q _{gs1} | Pre-V _{th} Gate-to-Source Charge | — | 3.6 | — | | |
| Q _{gs2} | Post-V _{th} Gate-to-Source Charge | — | 1.9 | — | | |
| Q _{gd} | Gate-to-Drain Charge | — | 6.5 | — | | |
| Q _{godr} | Gate Charge Overdrive | — | 9 | — | | |
| Q _{sw} | Switch Charge (Q _{gs2} + Q _{gd}) | — | 8.4 | — | | |
| Q _{oss} | Output Charge | — | 7.4 | — | nC | V _{DS} = 16V, V _{GS} = 0V |
| R _G | Gate Resistance | — | 1.1 | — | Ω | |
| t _{d(on)} | Turn-On Delay Time | — | 5.4 | — | ns | V _{DD} = 30V, V _{GS} = 10V I _D = 24A R _G = 1.7Ω |
| t _r | Rise Time | — | 8.7 | — | | |
| t _{d(off)} | Turn-Off Delay Time | — | 12 | — | | |
| t _f | Fall Time | — | 3.5 | — | | |
| C _{iss} | Input Capacitance | — | 1256 | — | pF | V _{GS} = 0V V _{DS} = 25V f = 1.0MHz |
| C _{oss} | Output Capacitance | — | 206 | — | | |
| C _{rss} | Reverse Transfer Capacitance | — | 92 | — | | |

Avalanche Characteristics

| | Parameter | Typ. | Max. | Units |
|-----------------|---------------------------------|------|------|-------|
| E _{AS} | Single Pulse Avalanche Energy ② | — | 45 | mJ |
| I _{AR} | Avalanche Current ① | — | 24 | A |

Diode Characteristics

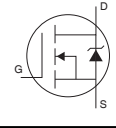
| | Parameter | Min. | Typ. | Max. | Units | Conditions |
|-----------------|--|---|------|------|-------|--|
| I _S | Continuous Source Current (Body Diode) | — | — | 40 | A | MOSFET symbol showing the integral reverse p-n junction diode.  |
| I _{SM} | Pulsed Source Current (Body Diode) ① | — | — | 160 | | |
| V _{SD} | Diode Forward Voltage | — | — | 1.3 | V | T _J = 25°C, I _S = 24A, V _{GS} = 0V ③ |
| t _{rr} | Reverse Recovery Time | — | 20 | 30 | ns | T _J = 25°C, I _F = 24A, V _{DD} = 30V |
| Q _{rr} | Reverse Recovery Charge | — | 74 | 111 | nC | di/dt = 500A/μs ③ |
| t _{on} | Forward Turn-On Time | Time is dominated by parasitic Inductance | | | | |

Thermal Resistance

| | Parameter | Typ. | Max. | Units |
|---------------------------|-----------------------|------|------|-------|
| R _{θJC} (Bottom) | Junction-to-Case ④ | — | 2.7 | °C/W |
| R _{θJC} (Top) | Junction-to-Case ④ | — | 15 | |
| R _{θJA} | Junction-to-Ambient ⑤ | — | 35 | |
| R _{θJA} (<10s) | Junction-to-Ambient ⑤ | — | 22 | |

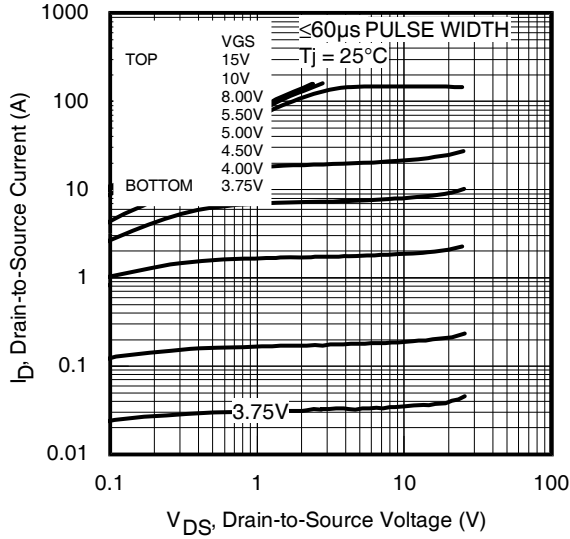

Fig 1. Typical Output Characteristics

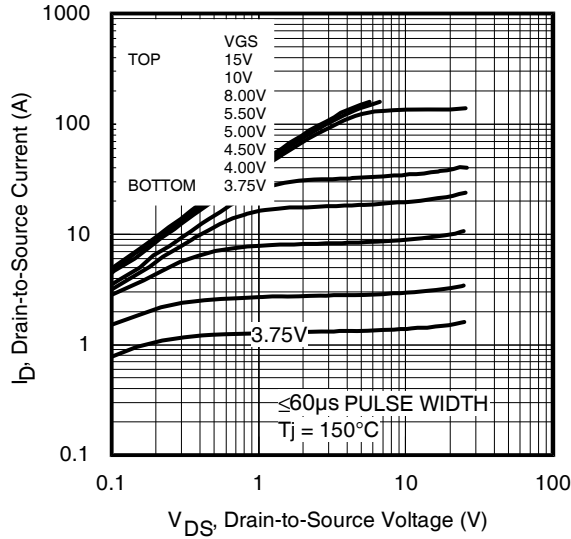

Fig 2. Typical Output Characteristics

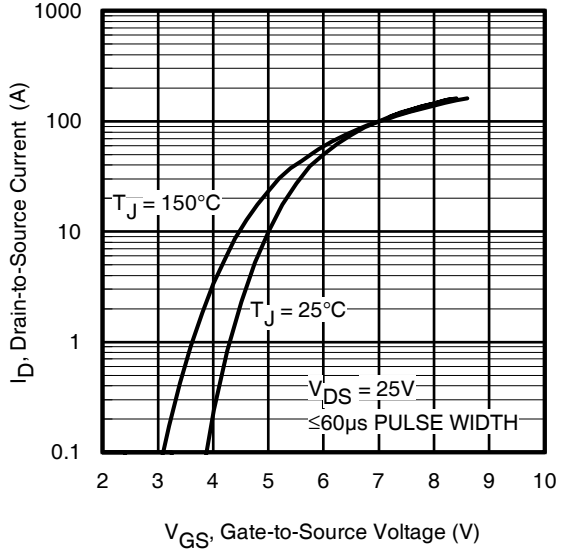

Fig 3. Typical Transfer Characteristics

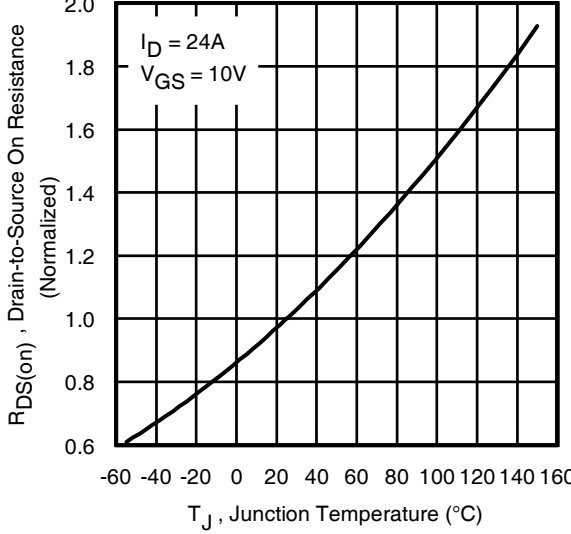

Fig 4. Normalized On-Resistance Vs. Temperature

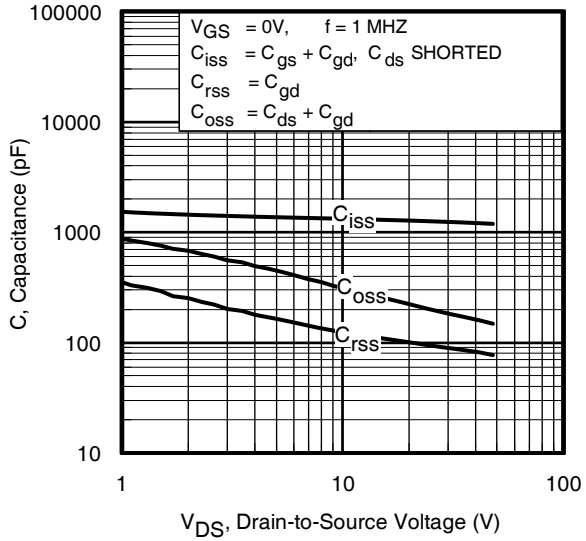

Fig 5. Typical Capacitance Vs. Drain-to-Source Voltage

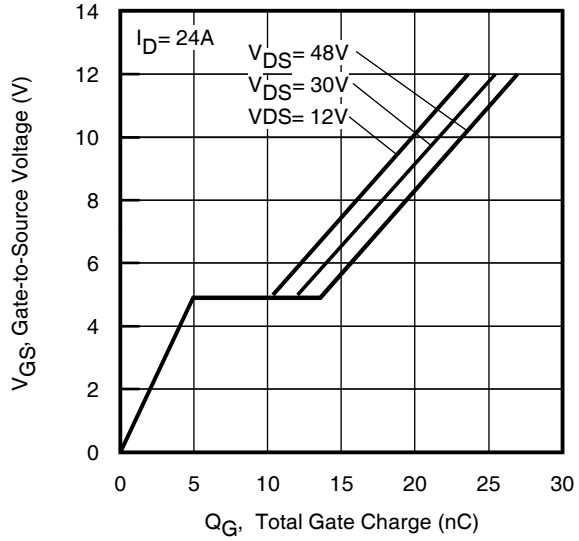
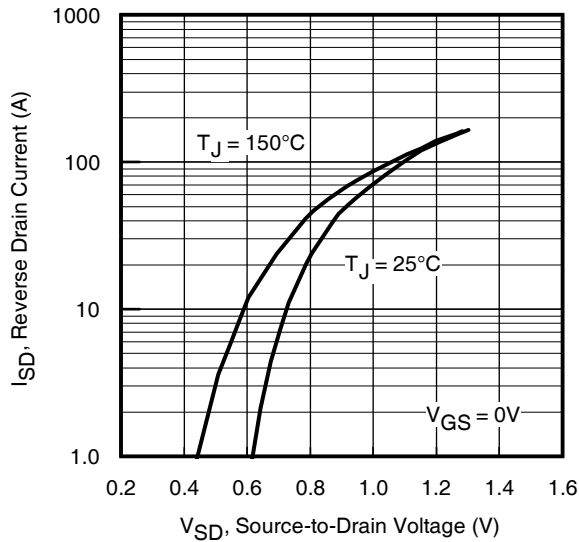
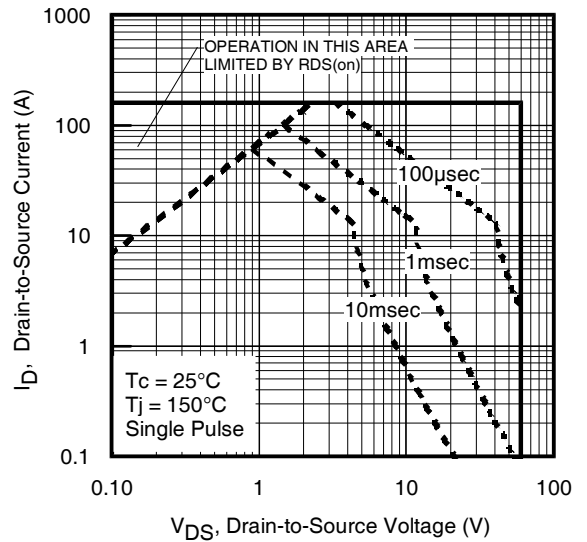
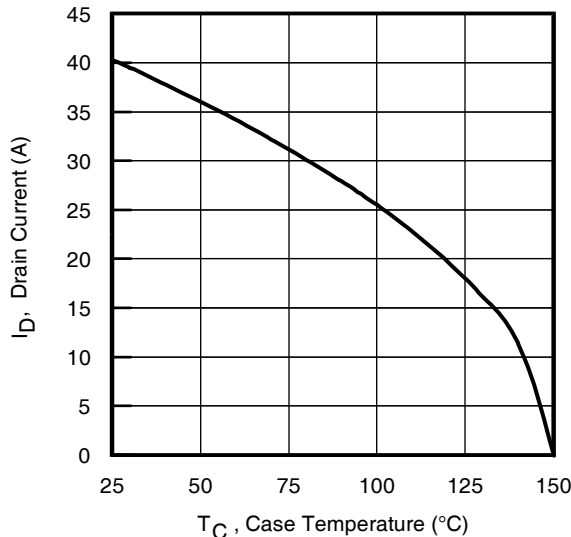
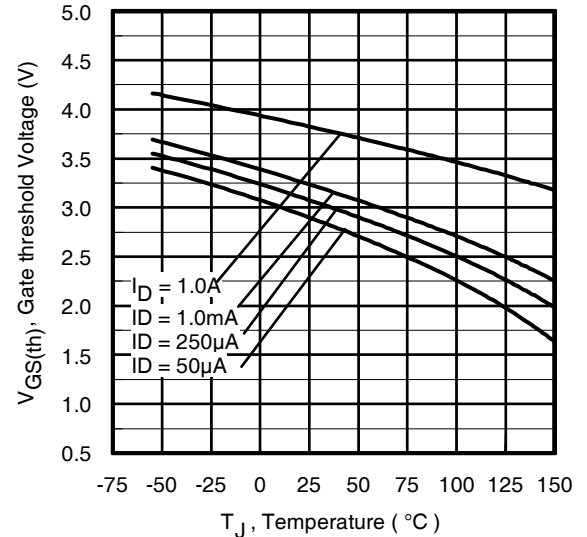
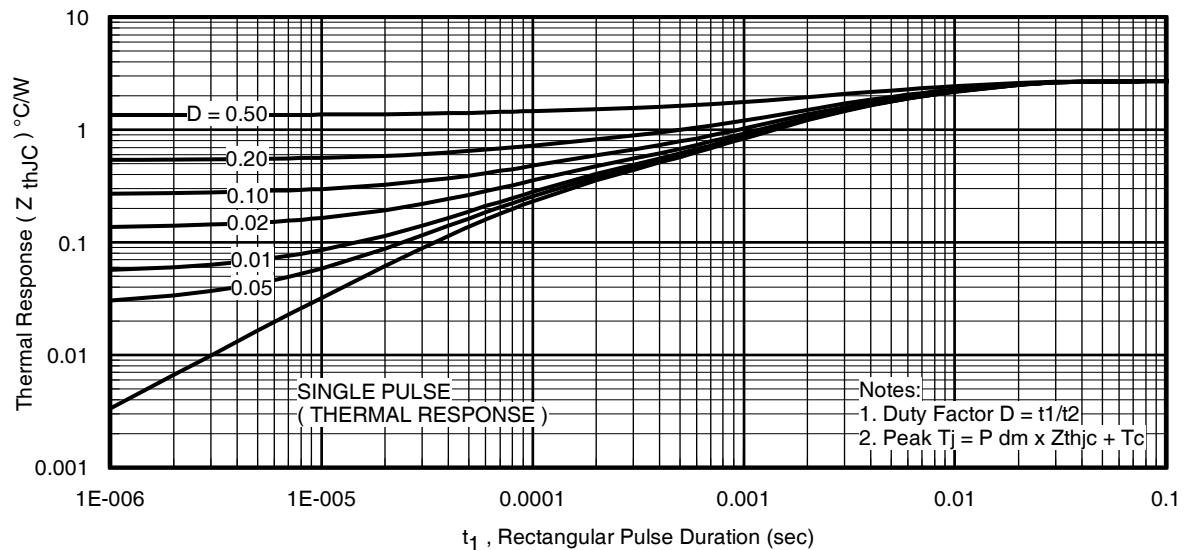

Fig 6. Typical Gate Charge Vs. Gate-to-Source Voltage

Fig 7. Typical Source-Drain Diode Forward Voltage

Fig 8. Maximum Safe Operating Area

Fig 9. Maximum Drain Current Vs. Case (Bottom) Temperature

Fig 10. Threshold Voltage Vs. Temperature

Fig 11. Maximum Effective Transient Thermal Impedance, Junction-to-Case (Bottom)

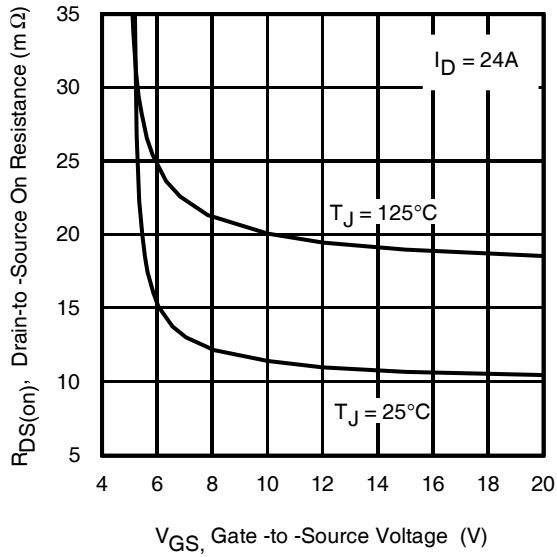

Fig 12. On-Resistance vs. Gate Voltage

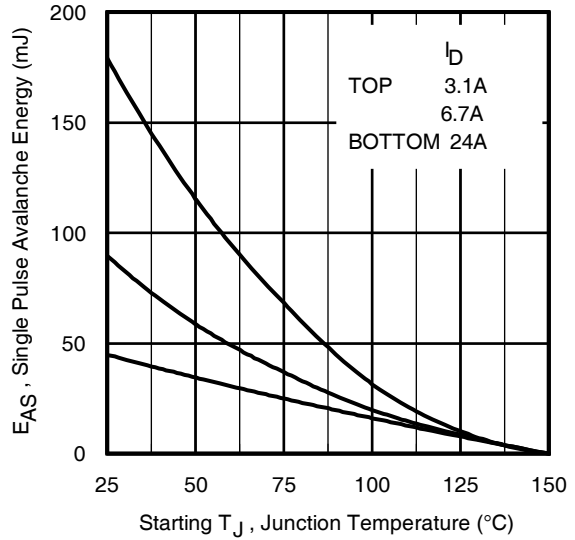

Fig 13. Maximum Avalanche Energy vs. Drain Current

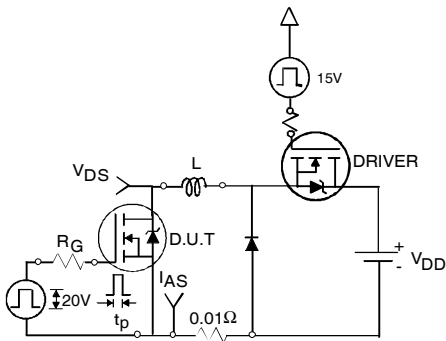

Fig 14a. Unclamped Inductive Test Circuit

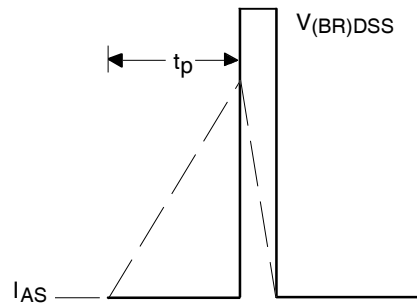

Fig 14b. Unclamped Inductive Waveforms

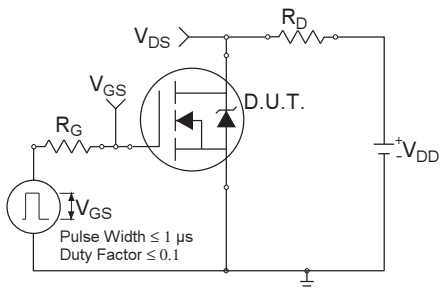

Fig 15a. Switching Time Test Circuit

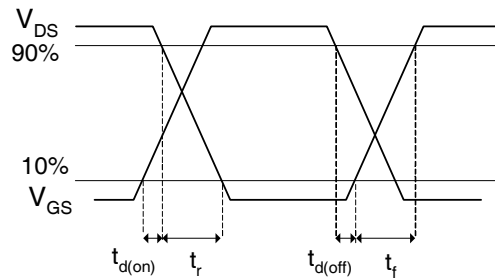

Fig 15b. Switching Time Waveforms

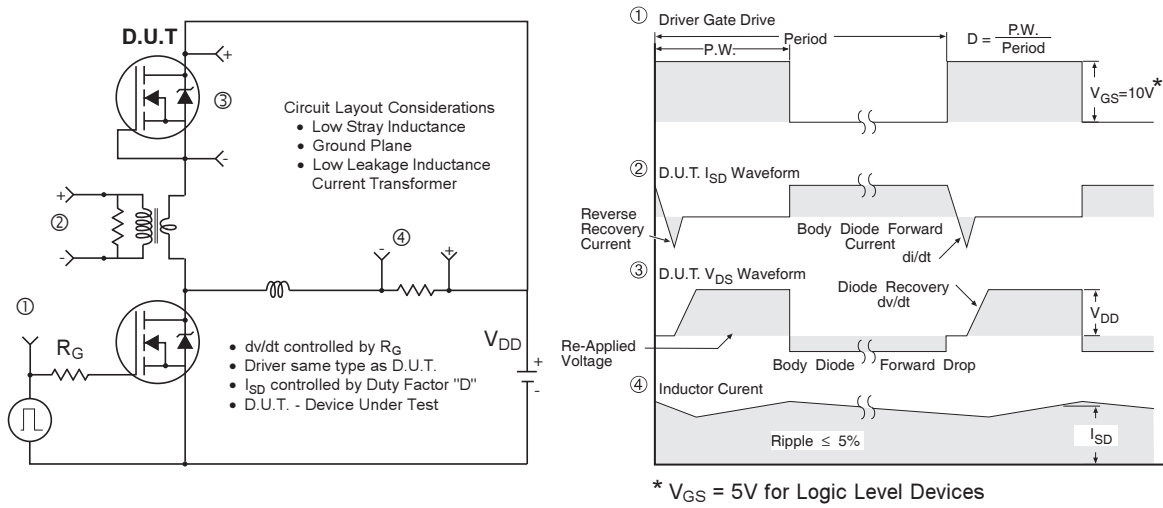

Fig 16. Peak Diode Recovery dv/dt Test Circuit for N-Channel HEXFET[®] Power MOSFETs

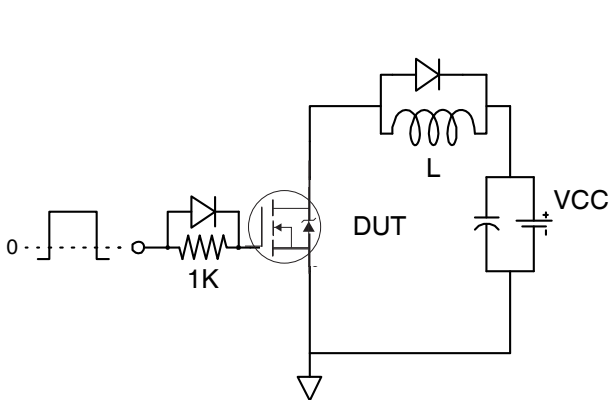

Fig 17. Gate Charge Test Circuit

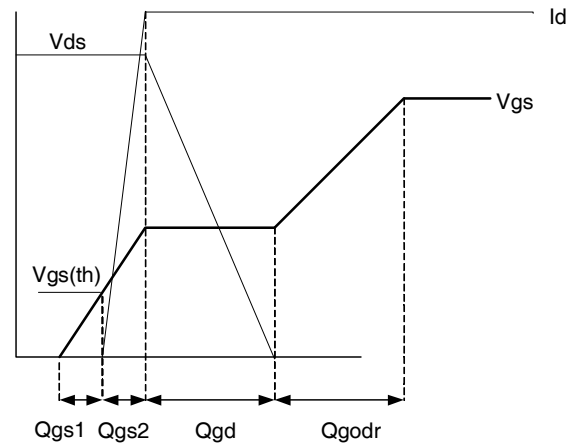
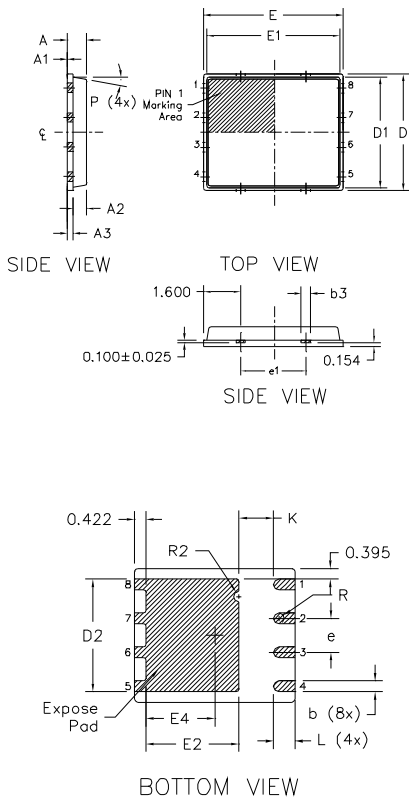

Fig 18. Gate Charge Waveform

PQFN 5x6 Outline "B" Package Details



| DIM SYMBOL | MILLIMETERS | | INCH | |
|---------------|-------------|-------|------------|--------|
| | MIN | MAX | MIN | MAX |
| A | 0.800 | 0.900 | 0.0315 | 0.0543 |
| A1 | 0.000 | 0.050 | 0.0000 | 0.0020 |
| A3 | 0.200 REF | | 0.0079 REF | |
| b | 0.350 | 0.470 | 0.0138 | 0.0185 |
| b1 | 0.025 | 0.125 | 0.0010 | 0.0049 |
| b2 | 0.210 | 0.410 | 0.0083 | 0.0161 |
| b3 | 0.150 | 0.450 | 0.0059 | 0.0177 |
| D | 5.000 BSC | | 0.1969 BSC | |
| D1 | 4.750 BSC | | 0.1870 BSC | |
| D2 | 4.100 | 4.300 | 0.1614 | 0.1693 |
| E | 6.000 BSC | | 0.2362 BSC | |
| E1 | 5.750 BSC | | 0.2264 BSC | |
| E2 | 3.380 | 3.780 | 0.1331 | 0.1488 |
| e | 1.270 REF | | 0.0500 REF | |
| e1 | 2.800 REF | | 0.1102 REF | |
| K | 1.200 | 1.420 | 0.0472 | 0.0559 |
| L | 0.710 | 0.900 | 0.0280 | 0.0354 |
| P | 0° | 12° | 0° | 12° |
| R | 0.200 REF | | 0.0079 REF | |
| R2 | 0.150 | 0.200 | 0.0059 | 0.0079 |

Note:

- Dimensions and tolerancing confirm to ASME Y14.5M-1994
- Dimension L represents terminal full back from package edge up to 0.1mm is acceptable
- Coplanarity applies to the expose Heat Slug as well as the terminal
- Radius on terminal is Optional

For more information on board mounting, including footprint and stencil recommendation, please refer to application note AN-1136: <http://www.irf.com/technical-info/appnotes/an-1136.pdf>

For more information on package inspection techniques, please refer to application note AN-1154: <http://www.irf.com/technical-info/appnotes/an-1154.pdf>

PQFN 5x6 Part Marking

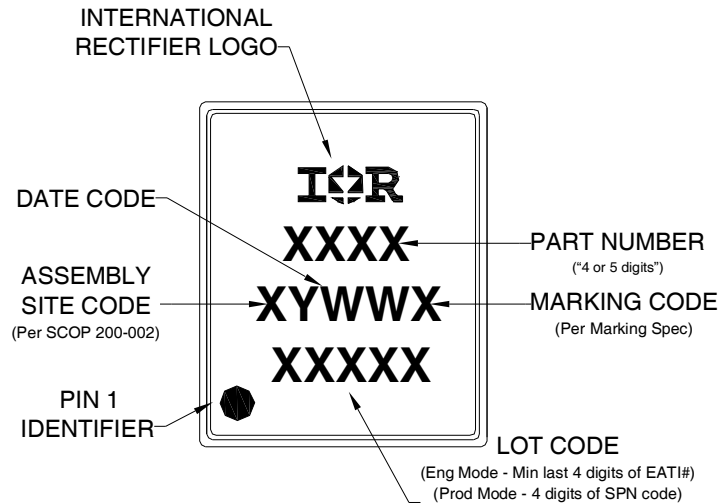

Note: For the most current drawing please refer to IR website at: <http://www.irf.com/package/>

PQFN 5x6 Tape and Reel

REEL DIMENSIONS

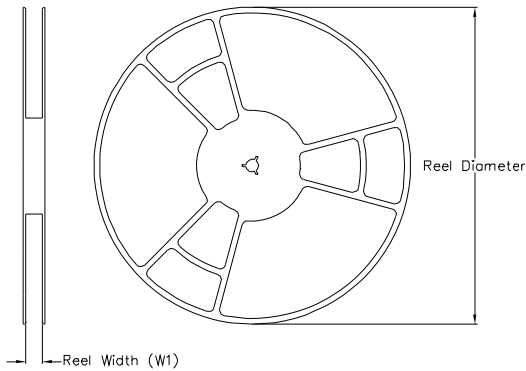

TAPE DIMENSIONS

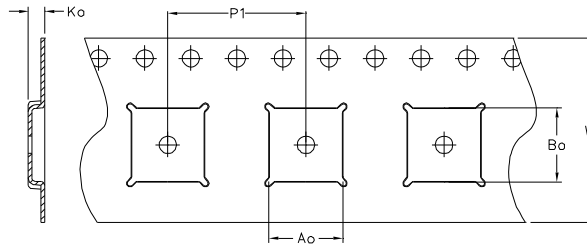

| CODE | DESCRIPTION |
|------|---|
| Ao | Dimension design to accommodate the component width |
| Bo | Dimension design to accommodate the component length |
| Ko | Dimension design to accommodate the component thickness |
| W | Overall width of the carrier tape |
| P1 | Pitch between successive cavity centers |

QUADRANT ASSIGNMENTS FOR PIN 1 ORIENTATION IN TAPE

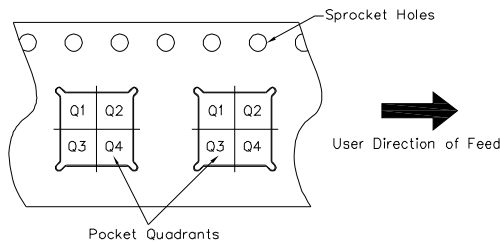

Note: All dimension are nominal

| Package Type | Reel Diameter (Inch) | QTY | Reel Width W1 (mm) | Ao (mm) | Bo (mm) | Ko (mm) | P1 (mm) | W (mm) | Pin 1 Quadrant |
|--------------|----------------------|------|--------------------|---------|---------|---------|---------|--------|----------------|
| 5 X 6 PQFN | 13 | 4000 | 12.4 | 6.300 | 5.300 | 1.20 | 8.00 | 12 | Q1 |

Note: For the most current drawing please refer to IR website at: <http://www.irf.com/package/>

Qualification information[†]

| | | |
|----------------------------|---|---|
| Qualification level | Industrial ^{††} (per JEDEC JESD47F ^{†††} guidelines) | |
| Moisture Sensitivity Level | PQFN 5mm x 6mm | MSL1 (per JEDEC J-ST D-020D ^{†††}) |
| RoHS compliant | Yes | |

† Qualification standards can be found at International Rectifier’s web site
<http://www.irf.com/product-info/reliability>

†† Higher qualification ratings may be available should the user have such requirements.
 Please contact your International Rectifier sales representative for further information:
<http://www.irf.com/whoto-call/salesrep/>

††† Applicable version of JEDEC standard at the time of product release.

Notes:

- ① Repetitive rating; pulse width limited by max. junction temperature.
- ② Starting $T_J = 25^{\circ}\text{C}$, $L = 0.156\text{mH}$, $R_G = 50\Omega$, $I_{AS} = 24\text{A}$.
- ③ Pulse width $\leq 400\mu\text{s}$; duty cycle $\leq 2\%$.
- ④ R_{θ} is measured at T_J of approximately 90°C .
- ⑤ When mounted on 1 inch square 2 oz copper pad on 1.5x1.5 in. board of FR-4 material.

| Date | Comments |
|------------|--|
| 12/16/2013 | <ul style="list-style-type: none"> • Updated ordering information to reflect the End-Of-life (EOL) of the mini-reel option (EOL notice #259) • Updated data sheet with new IR corporate template |
| 3/12/2015 | <ul style="list-style-type: none"> • Updated package outline and tape and reel on pages 7 and 8. |

IMPORTANT NOTICE

The information given in this document shall in no event be regarded as a guarantee of conditions or characteristics ("Beschaffenheitsgarantie").

With respect to any examples, hints or any typical values stated herein and/or any information regarding the application of the product, Infineon Technologies hereby disclaims any and all warranties and liabilities of any kind, including without limitation warranties of non-infringement of intellectual property rights of any third party.

In addition, any information given in this document is subject to customer's compliance with its obligations stated in this document and any applicable legal requirements, norms and standards concerning customer's products and any use of the product of Infineon Technologies in customer's applications.

The data contained in this document is exclusively intended for technically trained staff. It is the responsibility of customer's technical departments to evaluate the suitability of the product for the intended application and the completeness of the product information given in this document with respect to such application.

For further information on the product, technology, delivery terms and conditions and prices please contact your nearest Infineon Technologies office (www.infineon.com).

WARNINGS

Due to technical requirements products may contain dangerous substances. For information on the types in question please contact your nearest Infineon Technologies office.

Except as otherwise explicitly approved by Infineon Technologies in a written document signed by authorized representatives of Infineon Technologies, Infineon Technologies' products may not be used in any applications where a failure of the product or any consequences of the use thereof can reasonably be expected to result in personal injury.

Looking for pricing, stock, or lifecycle information?

Click below to explore more details on WIN SOURCE:

 [View IRFH5406TRPBF on WIN SOURCE](#)

 [Infineon Technologies](#) Information

Optimize Your Supply Chain with WIN SOURCE Solutions

-  Global Sourcing Solution
-  Obsolete Management
-  Cost Control Management
-  Shortage Management
-  Alternative Solution
-  Excess Inventory Management