



**THE DATASHEET OF  
MLZ2012M330WT000**



## Inductors for decoupling circuits

## Multilayer ferrite

## MLZ series



## MLZ2012 type



## FEATURES

- The MLZ series include inductors for decoupling circuits that have top-class DC superimposition characteristics and low DC resistance.
- They are compatible with wide frequency band noise, from low to high frequency.
- H type products have a rated current that is equivalent to that of wound coils.
- W type products are the new standard type products that have both large current and low resistance.
- L type products have a resistance up to 60% lower than W type products.
- Operating temperature range: -55 to +125°C (including self-temperature rise)

## APPLICATION

- Smart phones, tablet terminals, note PCs, various modules such as camera modules, DSCs, video games, portable memory audio devices, navigation systems, PNDs, WLANs, SSDs
- Application guides: [Smart phones/tablets](#)

## PART NUMBER CONSTRUCTION

MLZ	2012	M	1R0	H	T	000
Series name	L×W×H dimensions 2.0×1.25×0.85 mm 2.0×1.25×1.25 mm	Product internal code	Inductance (μH)	Characteristic type	Packaging style	Internal code

## CHARACTERISTICS SPECIFICATION TABLE

Type	L (μH)	Tolerance	Thickness		L measuring conditions		DC resistance (Ω)±30%	Isat*1 (mA)	Itemp*2 (mA)	Part No.
			T (mm)	Frequency (MHz)	Current (mA)					
Ultra-large current	1.0	±20%	1.25	2	0.1	0.10	700	800	<a href="#">MLZ2012M1R0HT000</a>	
	1.5	±20%	1.25	2	0.1	0.14	550	700	<a href="#">MLZ2012M1R5HT000</a>	
	2.2	±20%	1.25	2	0.1	0.16	400	600	<a href="#">MLZ2012M2R2HT000</a>	
	3.3	±20%	1.25	2	0.1	0.20	350	500	<a href="#">MLZ2012M3R3HT000</a>	
	4.7	±20%	1.25	2	0.1	0.34	300	400	<a href="#">MLZ2012M4R7HT000</a>	
	6.8	±20%	1.25	2	0.1	0.40	220	350	<a href="#">MLZ2012M6R8HT000</a>	
High frequency	10	±20%	1.25	2	0.1	0.68	200	300	<a href="#">MLZ2012M100HT000</a>	
	0.10	±20%	0.85	25	1.0	0.07	1000	1150	<a href="#">MLZ2012DR10DT000</a>	
	0.22	±20%	0.85	25	1.0	0.13	800	900	<a href="#">MLZ2012DR22DT000</a>	
	0.47	±20%	1.25	25	1.0	0.18	550	700	<a href="#">MLZ2012DR47DT000</a>	

\*1 Current assumed when inductance ratio has decreased by 50% max..

\*2 Current assumed when temperature has risen to 20°C max. (reference value). Operating temperature environment at this time: 105°C max.

## Measurement equipment

Measurement item	Product No.	Manufacturer
L	4294A+16034G	Keysight Technologies
DC resistance	Type-7561	Yokogawa

\* Equivalent measurement equipment may be used.



# MLZ2012 type

## CHARACTERISTICS SPECIFICATION TABLE

Type	L		Thickness T (mm)	L measuring conditions		DC resistance ( $\Omega$ ) $\pm$ 30%	Isat* <sup>1</sup> (mA)	Itemp* <sup>2</sup> (mA)	Part No.
	( $\mu$ H)	Tolerance		Frequency (MHz)	Current (mA)				
Large current	1.00	$\pm$ 20%	0.85	10	1.0	0.10	280	900	<a href="#">MLZ2012A1R0WT000</a>
	1.50	$\pm$ 20%	0.85	10	1.0	0.13	250	750	<a href="#">MLZ2012A1R5WT000</a>
	2.20	$\pm$ 20%	0.85	10	1.0	0.15	210	650	<a href="#">MLZ2012A2R2WT000</a>
	3.30	$\pm$ 20%	0.85	10	1.0	0.34	200	450	<a href="#">MLZ2012A3R3WT000</a>
	4.70	$\pm$ 20%	0.85	2	0.1	0.30	180	500	<a href="#">MLZ2012M4R7WT000</a>
	6.80	$\pm$ 20%	1.25	2	0.1	0.40	160	400	<a href="#">MLZ2012M6R8WT000</a>
	10.0	$\pm$ 20%	1.25	2	0.1	0.47	150	350	<a href="#">MLZ2012M100WT000</a>
	15.0	$\pm$ 20%	1.25	2	0.1	0.95	120	250	<a href="#">MLZ2012M150WT000</a>
	22.0	$\pm$ 20%	1.25	2	0.1	1.25	100	220	<a href="#">MLZ2012P220WT000</a>
	22.0	$\pm$ 20%	1.25	2	0.1	2.0	60	220	<a href="#">MLZ2012M220WT000</a>
Low resistance	33.0	$\pm$ 20%	1.25	2	0.1	2.60	55	190	<a href="#">MLZ2012M330WT000</a>
	47.0	$\pm$ 20%	1.25	2	0.1	3.70	50	170	<a href="#">MLZ2012M470WT000</a>
	1.00	$\pm$ 20%	0.85	2	0.1	0.06	220	1150	<a href="#">MLZ2012N1R0LT000</a>
	1.50	$\pm$ 20%	0.85	2	0.1	0.10	190	900	<a href="#">MLZ2012N1R5LT000</a>
	2.20	$\pm$ 20%	0.85	2	0.1	0.12	170	800	<a href="#">MLZ2012N2R2LT000</a>
	3.30	$\pm$ 20%	0.85	2	0.1	0.15	130	750	<a href="#">MLZ2012N3R3LT000</a>
	4.70	$\pm$ 20%	0.85	2	0.1	0.18	130	600	<a href="#">MLZ2012N4R7LT000</a>
	6.80	$\pm$ 20%	0.85	2	0.1	0.25	110	550	<a href="#">MLZ2012N6R8LT000</a>
	10.0	$\pm$ 20%	1.25	2	0.1	0.30	110	500	<a href="#">MLZ2012N100LT000</a>
	15.0	$\pm$ 20%	1.25	2	0.1	0.47	90	350	<a href="#">MLZ2012N150LT000</a>
22.0	$\pm$ 20%	1.25	2	0.1	0.67	70	300	<a href="#">MLZ2012N220LT000</a>	
100.0	$\pm$ 20%	1.25	2	0.1	3.50	30	140	<a href="#">MLZ2012N101LT000</a>	

\*<sup>1</sup> Current assumed when inductance ratio has decreased by 50% max..

\*<sup>2</sup> Current assumed when temperature has risen to 20°C max. (reference value). Operating temperature environment at this time: 105°C max.

### Measurement equipment

Measurement item	Product No.	Manufacturer
L	4294A+16034G	Keysight Technologies
DC resistance	Type-7561	Yokogawa

\* Equivalent measurement equipment may be used.

# MLZ2012 type

## L FREQUENCY CHARACTERISTICS H CHARACTERISTIC PRODUCT

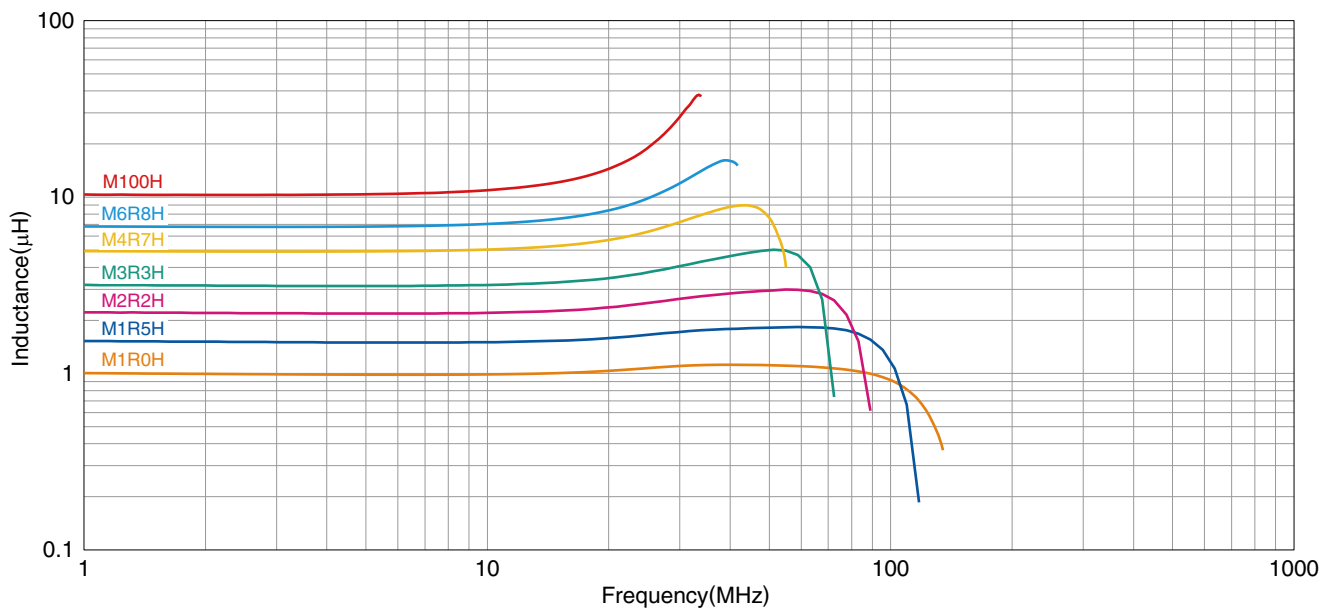

Measurement equipment

Product No.	Manufacturer
E4991A+16192A	Keysight Technologies

\* Equivalent measurement equipment may be used.

## L FREQUENCY CHARACTERISTICS D CHARACTERISTIC PRODUCT

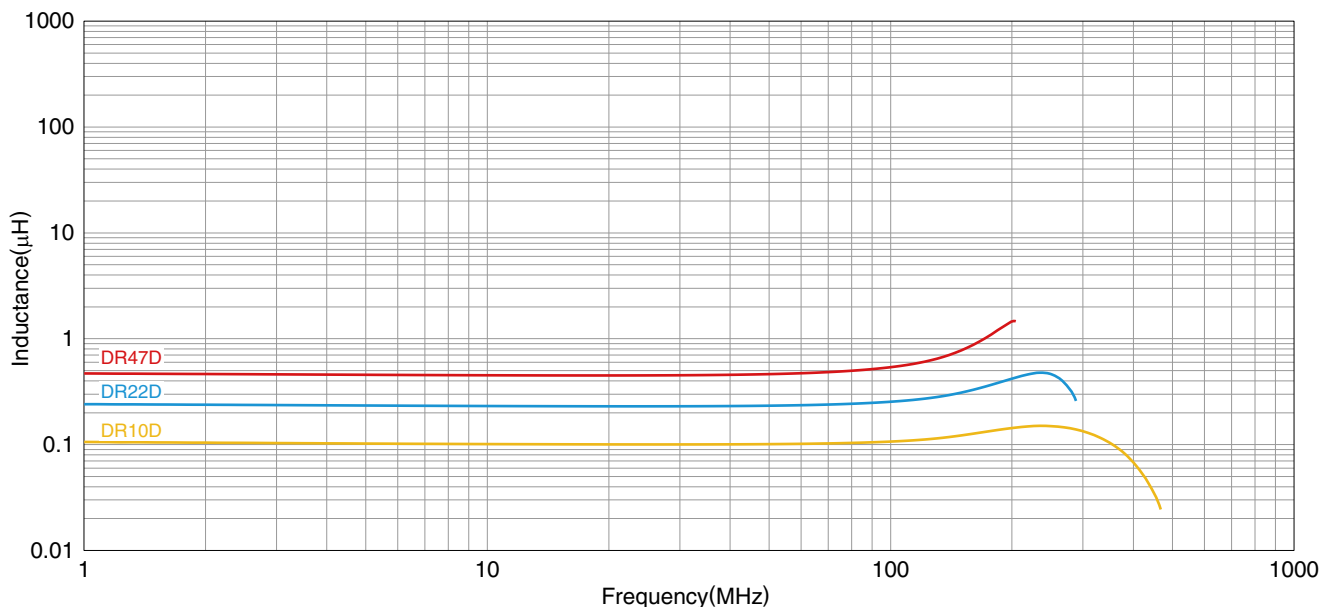

Measurement equipment

Product No.	Manufacturer
E4991A+16192A	Keysight Technologies

\* Equivalent measurement equipment may be used.

# MLZ2012 type

## ■ L FREQUENCY CHARACTERISTICS W CHARACTERISTIC PRODUCT



Measurement equipment

Product No.	Manufacturer
4291B+16200A+16192A	Keysight Technologies

\* Equivalent measurement equipment may be used.

# MLZ2012 type

## ■ L FREQUENCY CHARACTERISTICS L CHARACTERISTIC PRODUCT

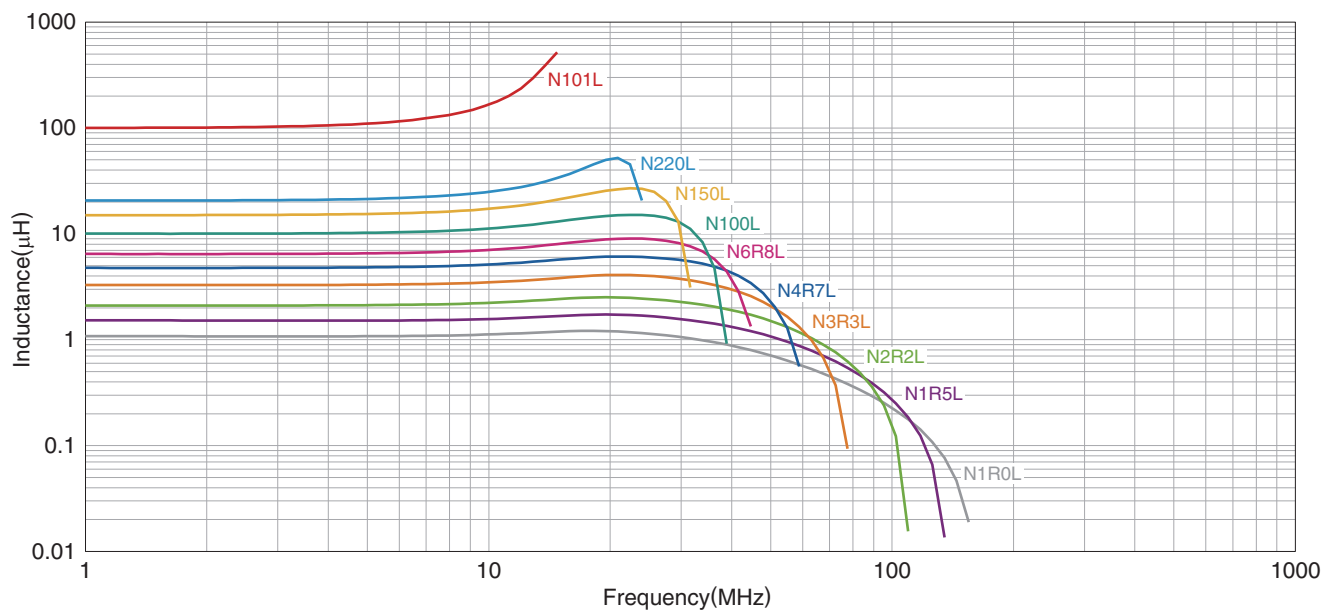

Measurement equipment

Product No.	Manufacturer
E4991A+16192A	Keysight Technologies

\* Equivalent measurement equipment may be used.

# MLZ2012 type

## INDUCTANCE VS. DC BIAS CHARACTERISTICS H CHARACTERISTIC PRODUCT

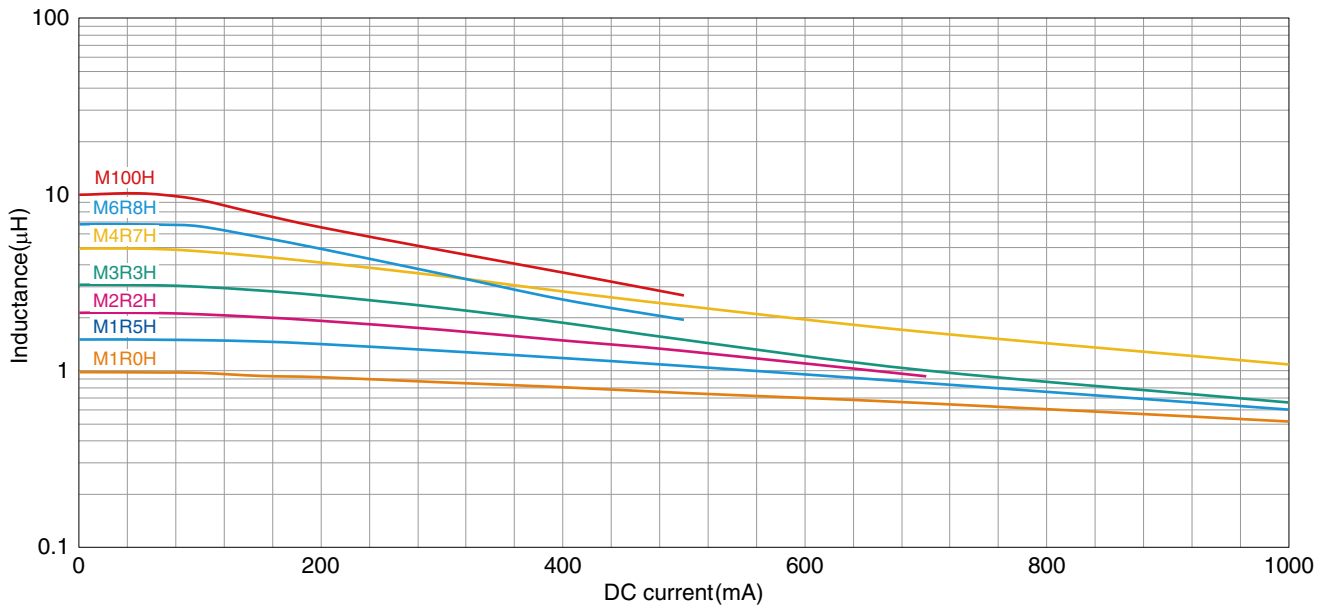

Measurement equipment

Product No.	Manufacturer
4291B+16200A+16192A	Keysight Technologies

\* Equivalent measurement equipment may be used.

## INDUCTANCE VS. DC BIAS CHARACTERISTICS D CHARACTERISTIC PRODUCT

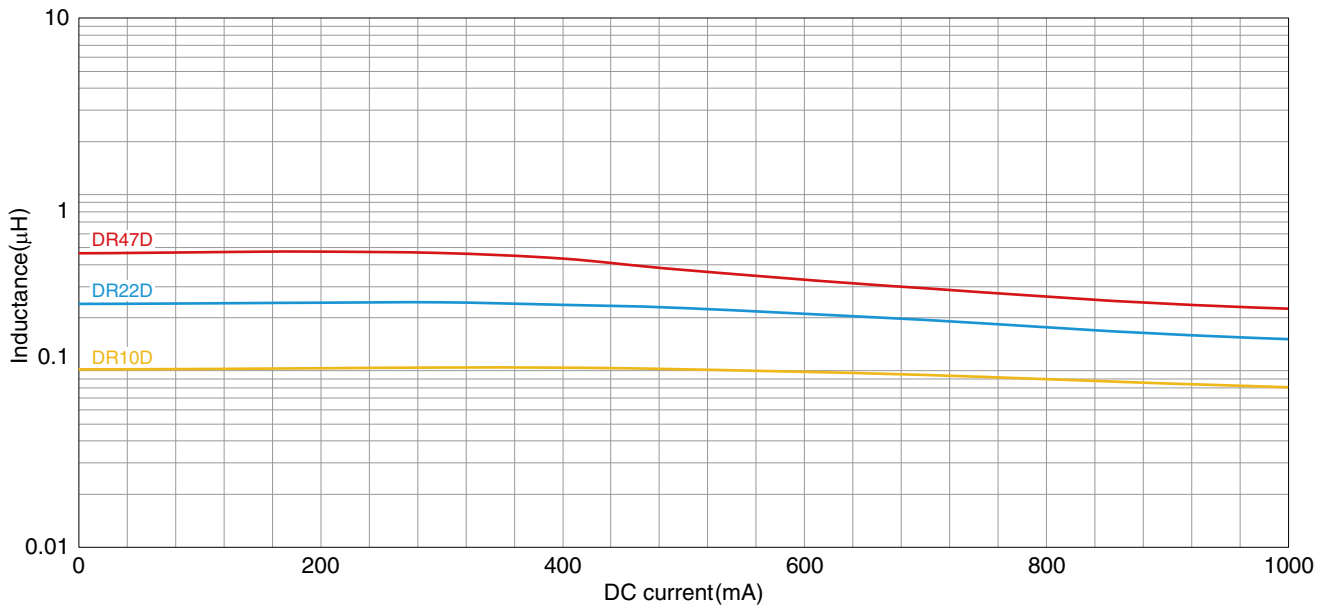

Measurement equipment

Product No.	Manufacturer
4291B+16200A+16192A	Keysight Technologies

\* Equivalent measurement equipment may be used.

# MLZ2012 type

## INDUCTANCE VS. DC BIAS CHARACTERISTICS W CHARACTERISTIC PRODUCT

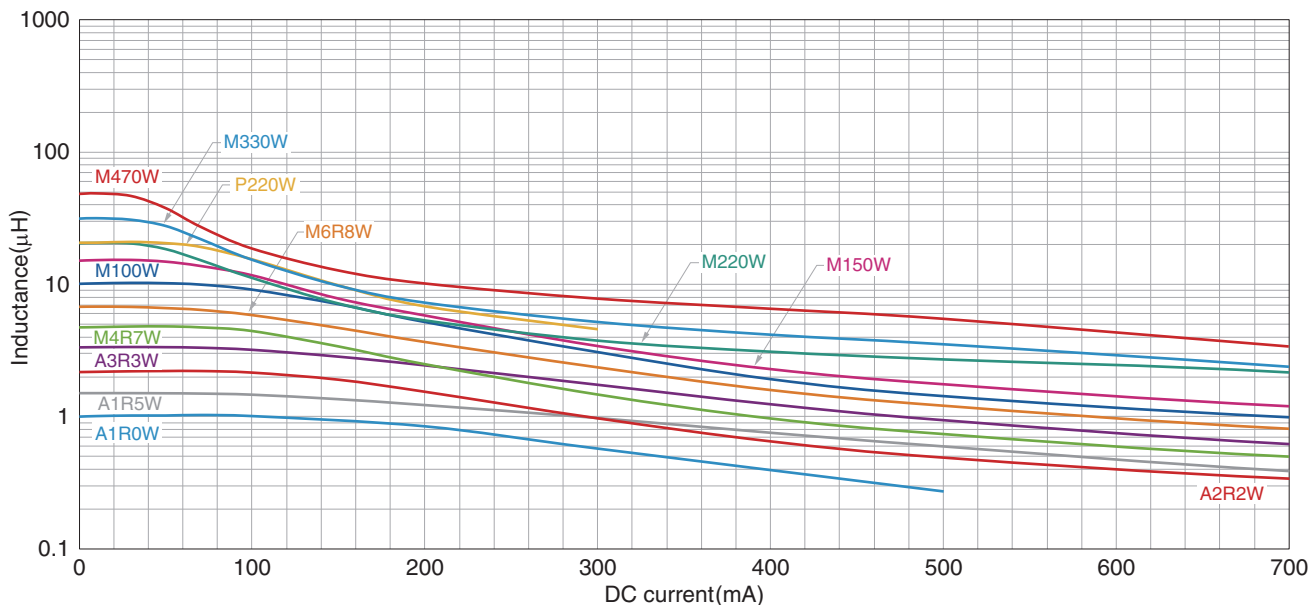

Measurement equipment

Product No.	Manufacturer
4291B+16200A+16192A	Keysight Technologies

\* Equivalent measurement equipment may be used.

## INDUCTANCE VS. DC BIAS CHARACTERISTICS L CHARACTERISTIC PRODUCT

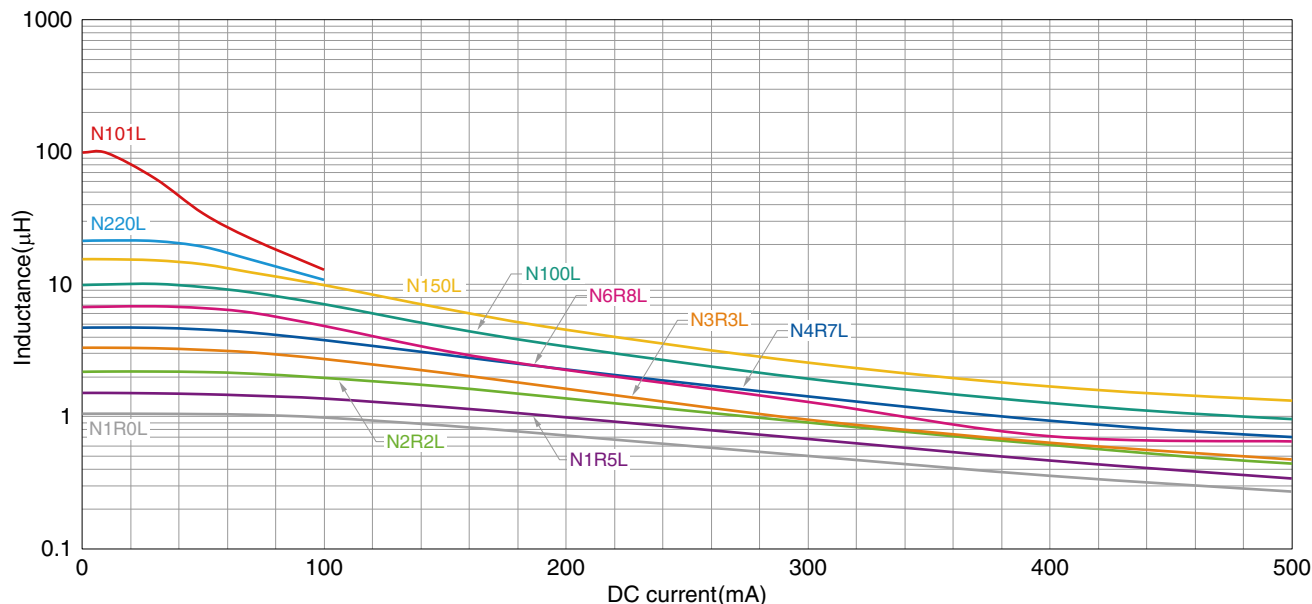

Measurement equipment

Product No.	Manufacturer
4291B+16200A+16192A	Keysight Technologies

\* Equivalent measurement equipment may be used.

# MLZ2012 type

## ■ IMPEDANCE FREQUENCY CHARACTERISTICS H CHARACTERISTIC PRODUCT

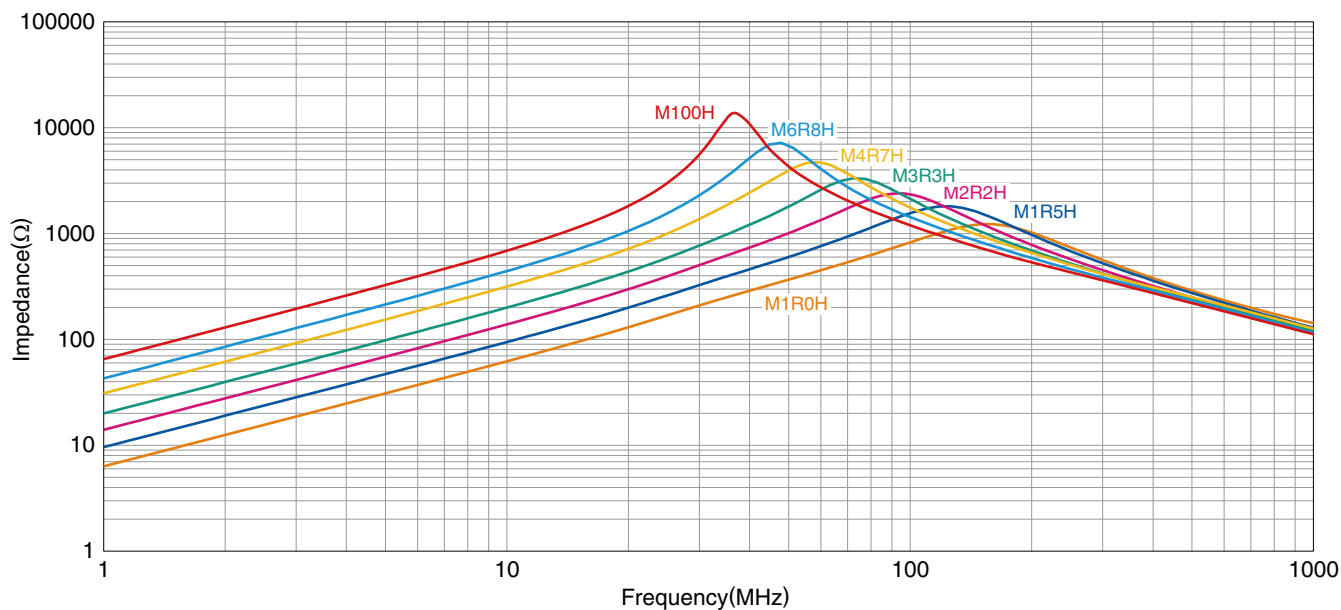

Measurement equipment

Product No.	Manufacturer
E4991A+16192A	Keysight Technologies

\* Equivalent measurement equipment may be used.

## ■ IMPEDANCE FREQUENCY CHARACTERISTICS D CHARACTERISTIC PRODUCT

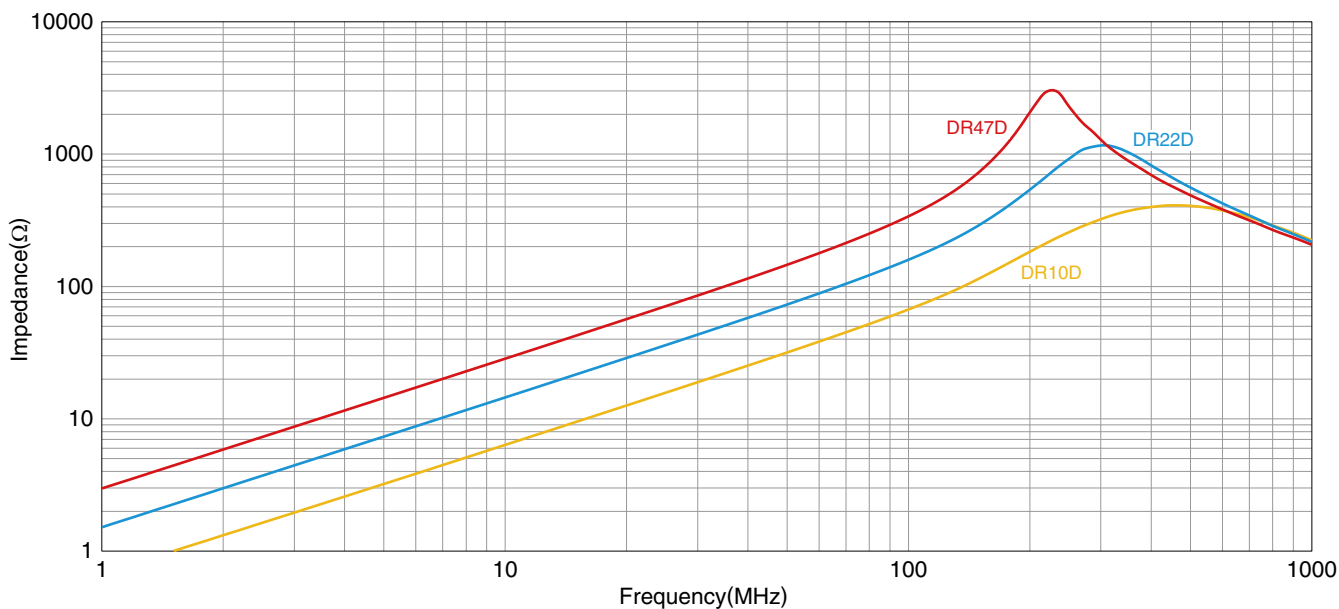

Measurement equipment

Product No.	Manufacturer
E4991A+16192A	Keysight Technologies

\* Equivalent measurement equipment may be used.

# MLZ2012 type

## ■ IMPEDANCE FREQUENCY CHARACTERISTICS W CHARACTERISTIC PRODUCT

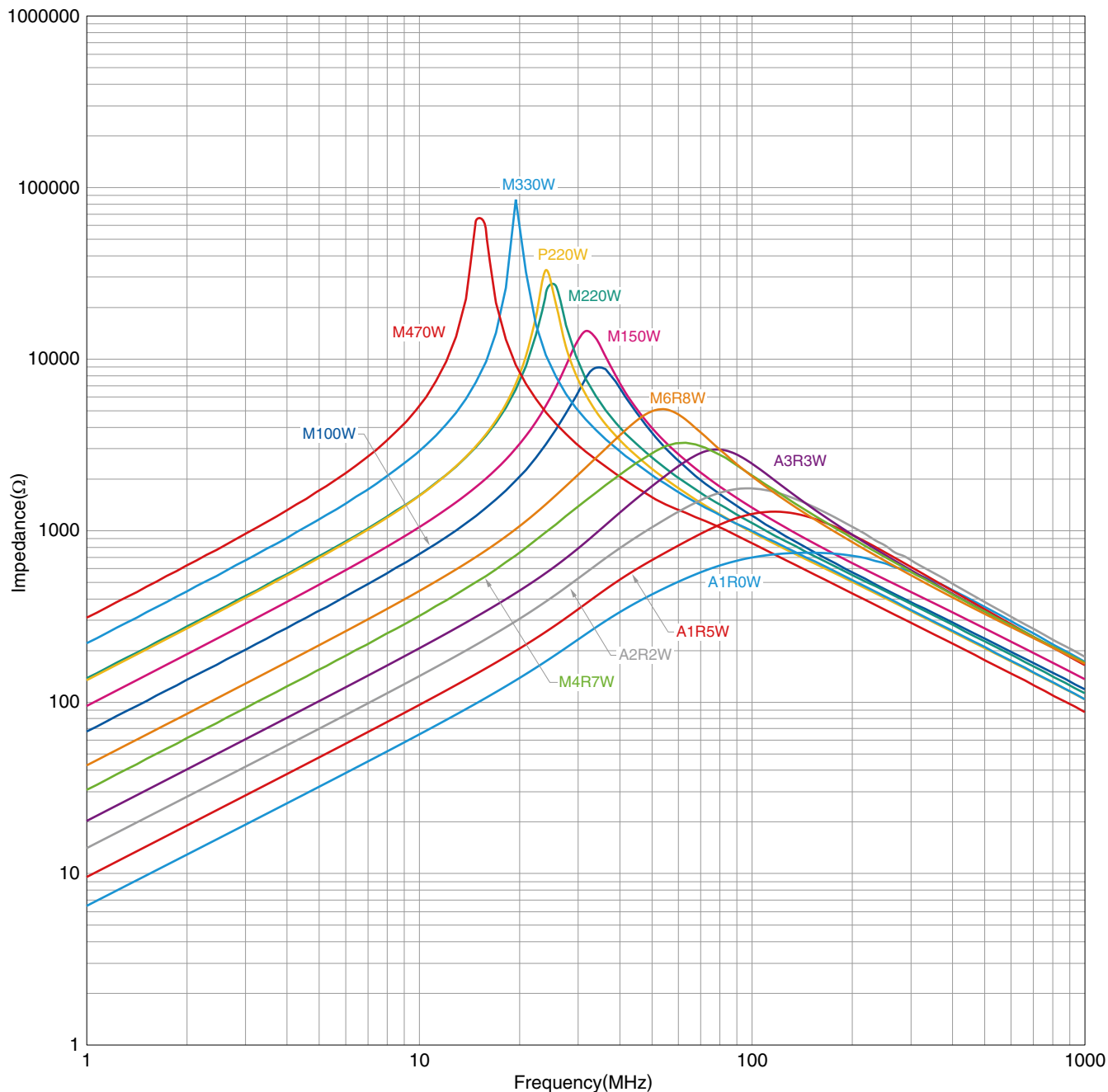

Measurement equipment

Product No.	Manufacturer
E4991A+16192A	Keysight Technologies

\* Equivalent measurement equipment may be used.

# MLZ2012 type

## ■ IMPEDANCE FREQUENCY CHARACTERISTICS L CHARACTERISTIC PRODUCT

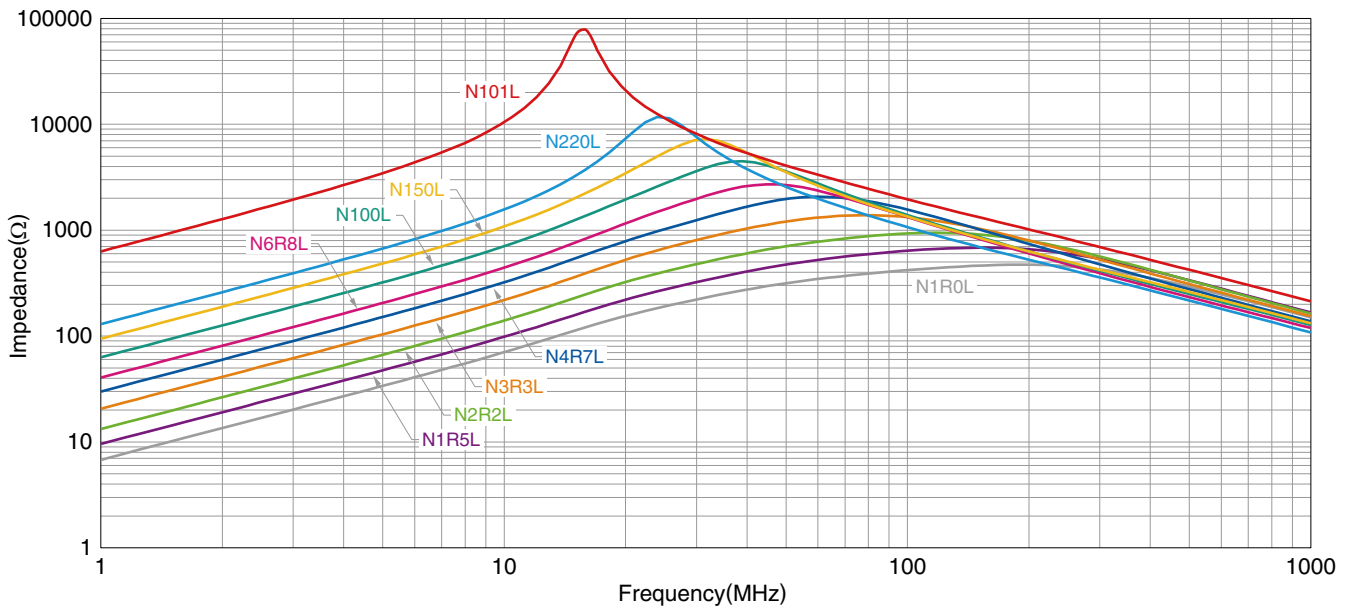

Measurement equipment

Product No.	Manufacturer
E4991A+16192A	Keysight Technologies

\* Equivalent measurement equipment may be used.

# MLZ2012 type

## SHAPE & DIMENSIONS

t=0.85mm

t=1.25mm

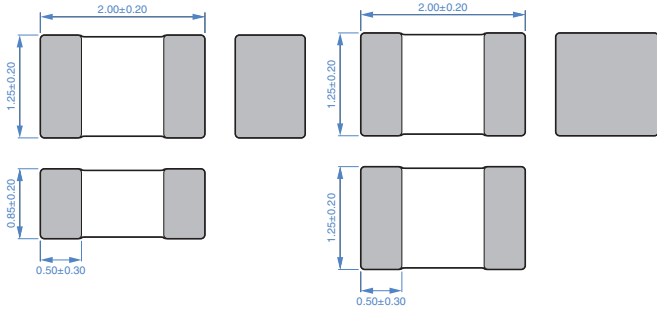

Dimensions in mm

## PACKAGING STYLE

### REEL DIMENSIONS

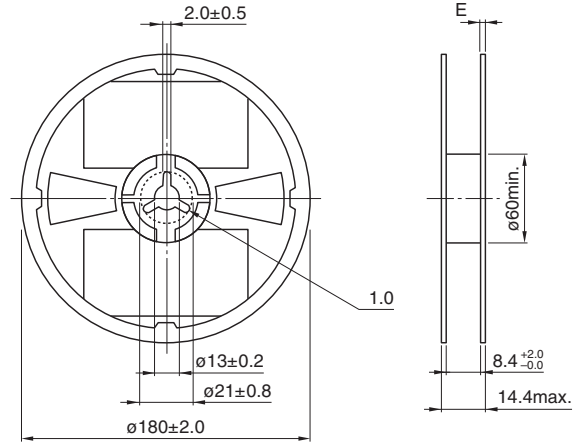

Dimensions in mm

## RECOMMENDED LAND PATTERN

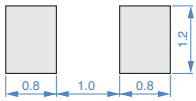

Dimensions in mm

### TAPE DIMENSIONS

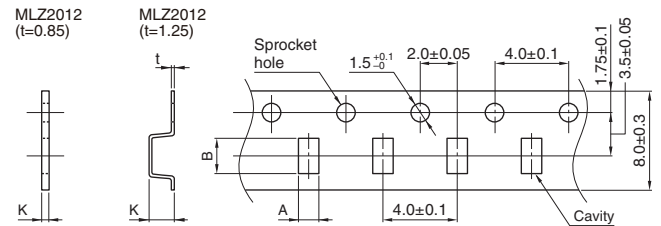

Dimensions in mm

Type		A	B	K
MLZ2012	t=0.85	1.5±0.2	2.3±0.2	1.1 max.
	t=1.25	1.5±0.2	2.3±0.2	1.5 max.

## RECOMMENDED REFLOW PROFILE

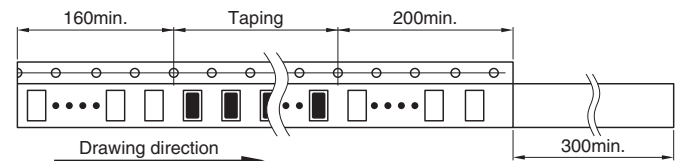
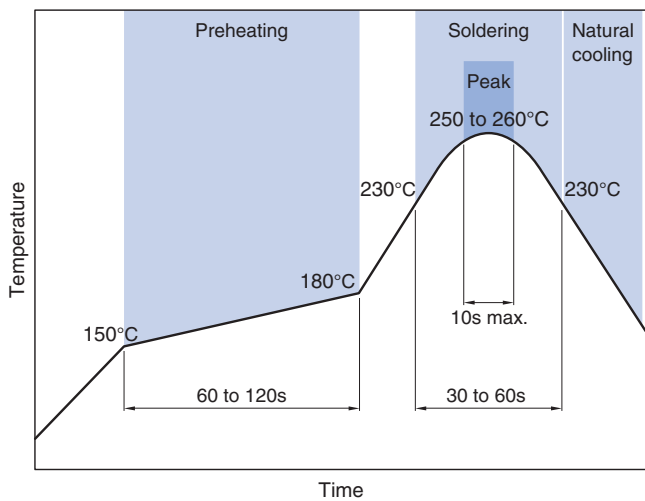

Dimensions in mm

### PACKAGE QUANTITY

Package quantity	t=0.85mm	4000 pcs/reel
	t=1.25mm	2000 pcs/reel

## TEMPERATURE RANGE, INDIVIDUAL WEIGHT

Type	Operating temperature range*	Storage temperature range**	Individual weight
t=0.85mm	-55 to +125 °C	-55 to +125 °C	10 mg
t=1.25mm	-55 to +125 °C	-55 to +125 °C	14 mg

\* Operating temperature range includes self-temperature rise.

\*\* The storage temperature range is for after the assembly.

## REMINDERS FOR USING THESE PRODUCTS

Before using these products, be sure to request the delivery specifications.

### SAFETY REMINDERS

Please pay sufficient attention to the warnings for safe designing when using this products.

#### REMINDERS

- The storage period is less than 12 months. Be sure to follow the storage conditions (temperature: 5 to 40°C, humidity: 10 to 75% RH or less).  
If the storage period elapses, the soldering of the terminal electrodes may deteriorate.
- Do not use or store in locations where there are conditions such as gas corrosion (salt, acid, alkali, etc.).
- Before soldering, be sure to preheat components.  
The preheating temperature should be set so that the temperature difference between the solder temperature and chip temperature does not exceed 150°C.
- Soldering corrections after mounting should be within the range of the conditions determined in the specifications.  
If overheated, a short circuit, performance deterioration, or lifespan shortening may occur.
- When embedding a printed circuit board where a chip is mounted to a set, be sure that residual stress is not given to the chip due to the overall distortion of the printed circuit board and partial distortion such as at screw tightening portions.
- Self heating (temperature increase) occurs when the power is turned ON, so the tolerance should be sufficient for the set thermal design.
- Carefully lay out the coil for the circuit board design of the non-magnetic shield type.  
A malfunction may occur due to magnetic interference.
- Use a wrist band to discharge static electricity in your body through the grounding wire.
- Do not expose the products to magnets or magnetic fields.
- Do not use for a purpose outside of the contents regulated in the delivery specifications.
- The products listed on this catalog are intended for use in general electronic equipment (AV equipment, telecommunications equipment, home appliances, amusement equipment, computer equipment, personal equipment, office equipment, measurement equipment, industrial robots) under a normal operation and use condition.  
The products are not designed or warranted to meet the requirements of the applications listed below, whose performance and/or quality require a more stringent level of safety or reliability, or whose failure, malfunction or trouble could cause serious damage to society, person or property.  
If you intend to use the products in the applications listed below or if you have special requirements exceeding the range or conditions set forth in the each catalog, please contact us.



- (1) Aerospace/aviation equipment
- (2) Transportation equipment (cars, electric trains, ships, etc.)
- (3) Medical equipment
- (4) Power-generation control equipment
- (5) Atomic energy-related equipment
- (6) Seabed equipment
- (7) Transportation control equipment

- (8) Public information-processing equipment
- (9) Military equipment
- (10) Electric heating apparatus, burning equipment
- (11) Disaster prevention/crime prevention equipment
- (12) Safety equipment
- (13) Other applications that are not considered general-purpose applications

When designing your equipment even for general-purpose applications, you are kindly requested to take into consideration securing protection circuit/device or providing backup circuits in your equipment.

## Looking for pricing, stock, or lifecycle information?

Click below to explore more details on WIN SOURCE:

-  [View MLZ2012M330WT000 on WIN SOURCE](#)
-  [TDK Corporation Information](#)

## Optimize Your Supply Chain with WIN SOURCE Solutions

-  Global Sourcing Solution
-  Obsolete Management
-  Cost Control Management
-  Shortage Management
-  Alternative Solution
-  Excess Inventory Management