

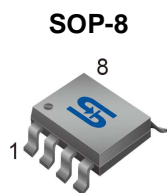

THE DATASHEET OF TSM9933DCS RLG





SOP-8

Pin Definition:

- | | |
|-------------|------------|
| 1. Source 1 | 8. Drain 1 |
| 2. Gate 1 | 7. Drain 1 |
| 3. Source 2 | 6. Drain 2 |
| 4. Gate 2 | 5. Drain 2 |

Key Parameter Performance

Parameter	Value	Unit
V_{DS}	-20	V
$R_{DS(on)}$ (max)	$V_{GS} = -4.5V$	60
	$V_{GS} = -2.7V$	78
	$V_{GS} = -2.5V$	85
Q_g	6	nC

Features

- Advance Trench Process Technology
- High Density Cell Design for Ultra Low On-resistance

Ordering Information

Part No.	Package	Packing
TSM9933DCS RLG	SOP-8	2.5kps / 13" Reel

Note: "G" denotes for Halogen- and Antimony-free as those which contain <900ppm bromine, <900ppm chlorine (<1500ppm total Br + Cl) and <1000ppm antimony compounds

Block Diagram

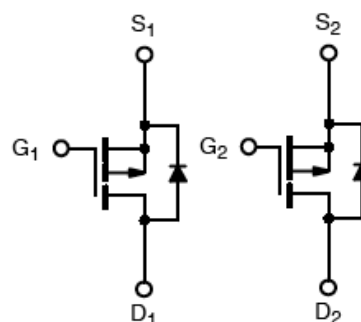

Dual P-Channel MOSFET

Absolute Maximum Ratings ($T_A=25^{\circ}C$ unless otherwise noted)

Parameter	Symbol	Limit	Unit
Drain-Source Voltage	V_{DS}	-20	V
Gate-Source Voltage	V_{GS}	± 12	V
Continuous Drain Current, V_{GS} @ 4.5V.	I_D	-4.7	A
Pulsed Drain Current, V_{GS} @ 4.5V	I_{DM}	-20	A
Continuous Source Current (Diode Conduction) ^(Note 1,2)	I_S	-2.5	A
Maximum Power Dissipation	P_D	$T_A=25^{\circ}C$	2
		$T_A=70^{\circ}C$	1.3
Operating Junction Temperature	T_J	+150	$^{\circ}C$
Operating Junction and Storage Temperature Range	T_J, T_{STG}	- 55 to +150	$^{\circ}C$

Thermal Performance

Parameter	Symbol	Limit	Unit
Junction to Case Thermal Resistance	$R_{\theta JC}$	30	$^{\circ}C/W$
Junction to Ambient Thermal Resistance (PCB mounted)	$R_{\theta JA}$	62.5	$^{\circ}C/W$

Electrical Specifications (T_J=25°C unless otherwise noted)

Parameter	Conditions	Symbol	Min	Typ	Max	Unit
Static (Note 3)						
Drain-Source Breakdown Voltage	V _{GS} = 0V, I _D = -250μA	BV _{DSS}	-20	--	--	V
Gate Threshold Voltage	V _{DS} = V _{GS} , I _D = -250μA	V _{GS(TH)}	-0.6	--	-1.4	V
Gate Body Leakage	V _{GS} = ±12V, V _{DS} = 0V	I _{GSS}	--	--	±100	nA
Zero Gate Voltage Drain Current	V _{DS} = -20V, V _{GS} = 0V	I _{DSS}	--	--	-1.0	μA
On-State Drain Current	V _{DS} = -5V, V _{GS} = -4.5V	I _{D(ON)}	-15	--	--	A
Drain-Source On-State Resistance	V _{GS} = -4.5V, I _D = -4.7A	R _{DS(ON)}	--	48	60	mΩ
	V _{GS} = -4.5V, I _D = -2.9A		--	47	58	
	V _{GS} = -2.7V, I _D = -1.5A		--	60	78	
	V _{GS} = -2.5V, I _D = -3.8A		--	65	85	
Forward Transconductance	V _{DS} = -10V, I _D = -4.7A	g _{fs}	--	11	--	S
Diode Forward Voltage	I _S = -1.7A, V _{GS} = 0V	V _{SD}	--	-0.8	-1.2	V
Dynamic (Note 4,5)						
Total Gate Charge	V _{DS} = -10V, I _D = -4.7A, V _{GS} = -4.5V	Q _g	--	6	9	nC
Gate-Source Charge		Q _{gs}	--	1.4	--	
Gate-Drain Charge		Q _{gd}	--	1.9	--	
Input Capacitance	V _{DS} = -10V, V _{GS} = 0V, f = 1.0MHz	C _{iss}	--	640	--	pF
Output Capacitance		C _{oss}	--	180	--	
Reverse Transfer Capacitance		C _{rss}	--	90	--	
Switching (Note 4,5)						
Turn-On Delay Time	V _{DD} = -10V, R _L = 10Ω, I _D = -1A, V _{GEN} = -4.5V, R _G = 6Ω	t _{d(on)}	--	22	35	ns
Turn-On Rise Time		t _r	--	35	55	
Turn-Off Delay Time		t _{d(off)}	--	45	70	
Turn-Off Fall Time		t _f	--	25	50	

Notes:

1. Pulse width limited by the Maximum junction temperature
2. Surface Mounted on FR4 Board, t ≤ 5 sec.
3. pulse test: PW ≤ 300μs, duty cycle ≤ 2%
4. For DESIGN AID ONLY, not subject to production testing.
5. Switching time is essentially independent of operating temperature.

Electrical Characteristics Curves

Output Characteristics

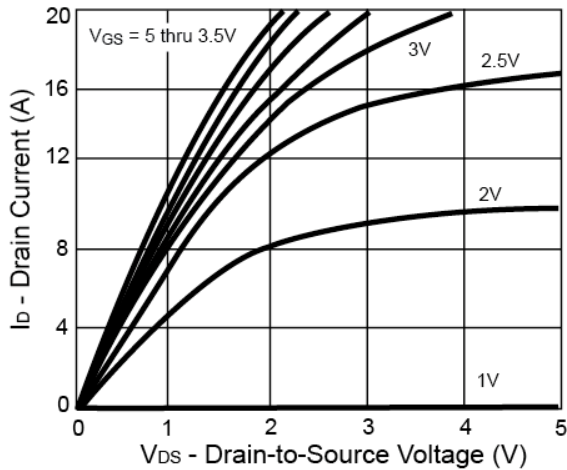

Transfer Characteristics

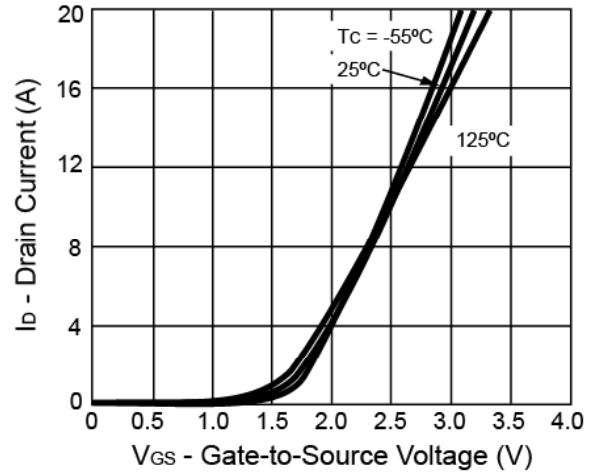

On-Resistance vs. Drain Current

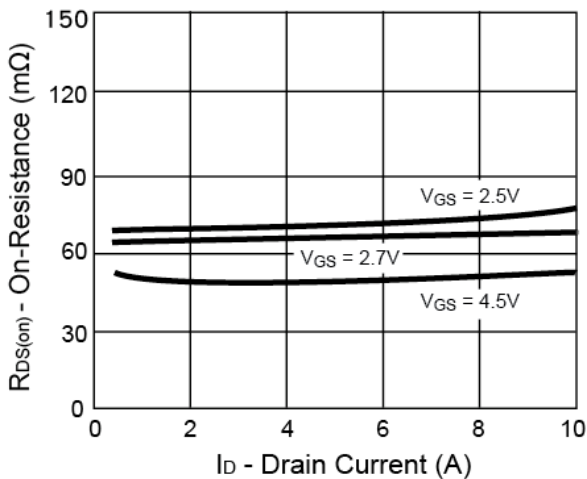

Gate Charge

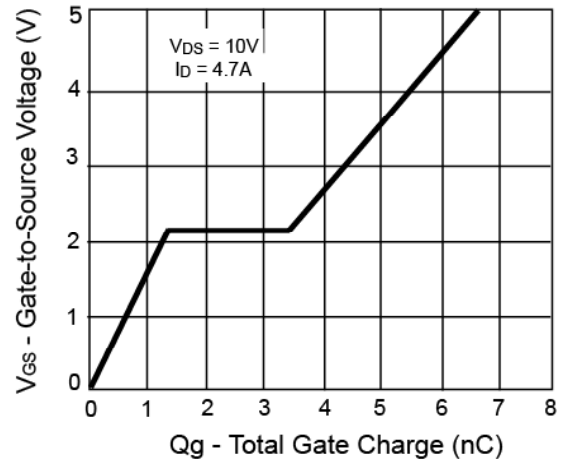

On-Resistance vs. Junction Temperature

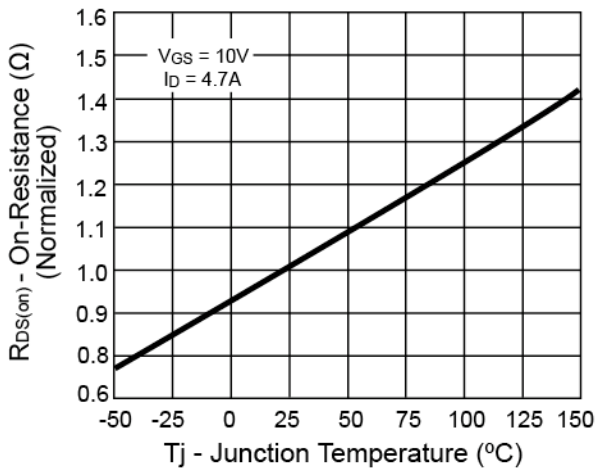

Source-Drain Diode Forward Voltage

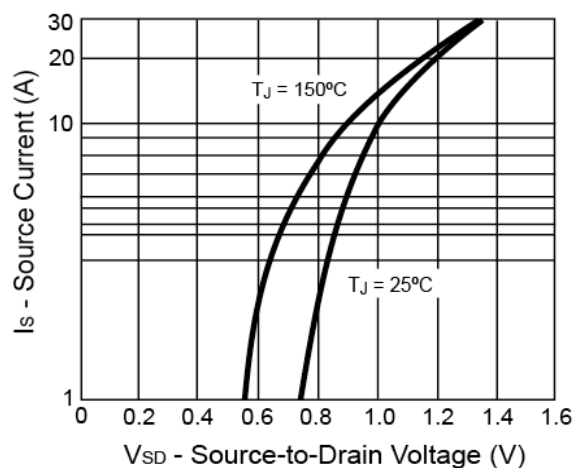

Electrical Characteristics Curves

On-Resistance vs. Gate-Source Voltage

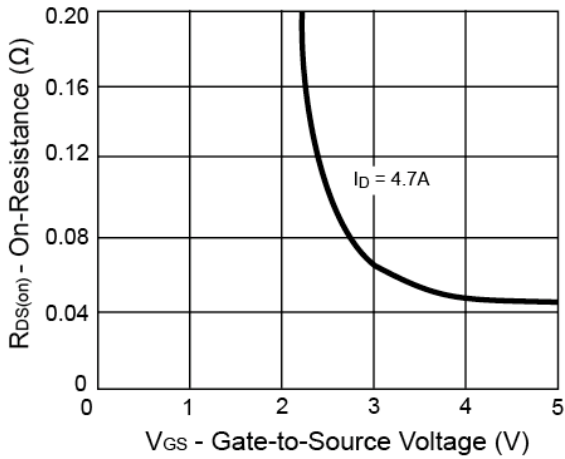

Threshold Voltage

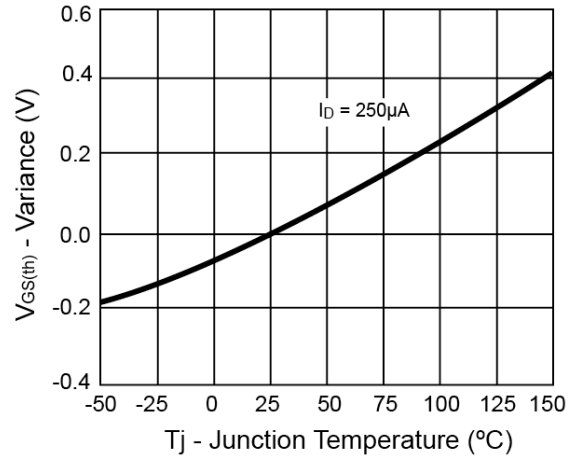

Single Pulse Power

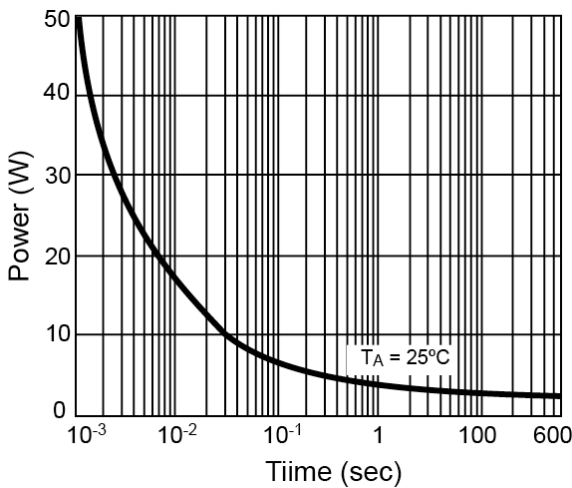

Normalized Thermal Transient Impedance, Junction-to-Ambient

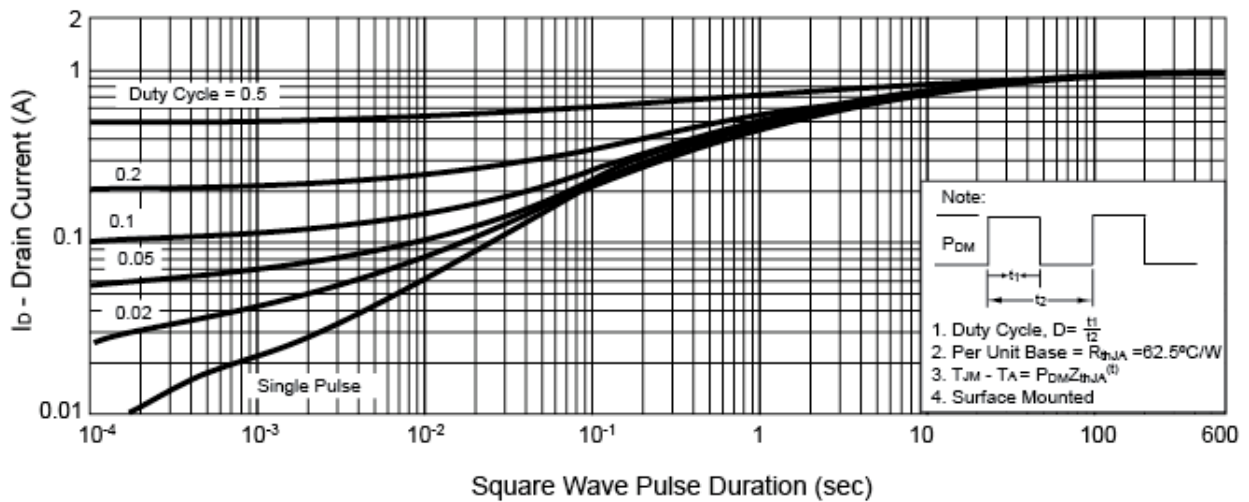



SOP-8 Mechanical Drawing

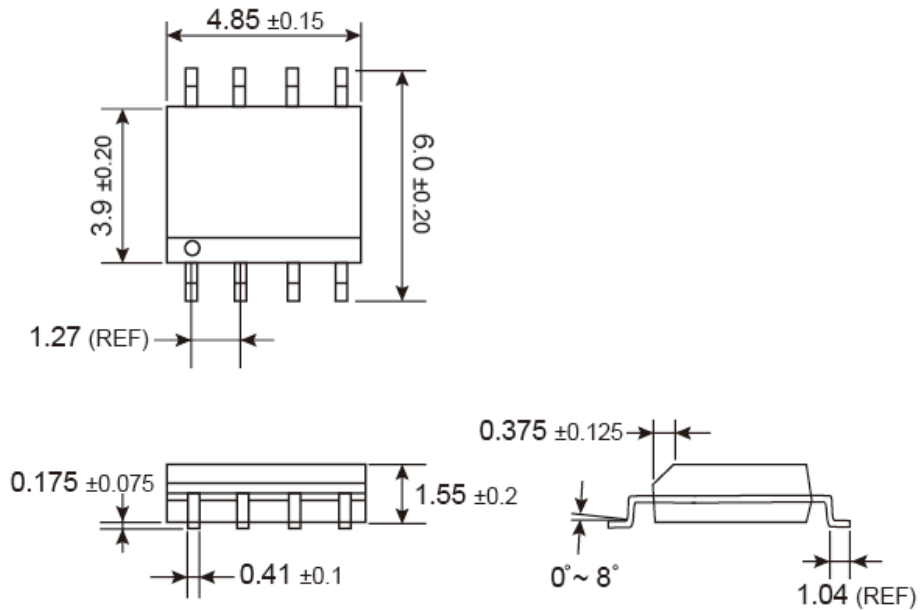

Unit: Millimeters

Marking Diagram

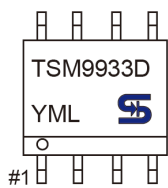

- Y** = Year Code
- M** = Month Code for Halogen Free Product
 - O** =Jan **P** =Feb **Q** =Mar **R** =Apr
 - S** =May **T** =Jun **U** =Jul **V** =Aug
 - W** =Sep **X** =Oct **Y** =Nov **Z** =Dec
- L** = Lot Code

Notice

Specifications of the products displayed herein are subject to change without notice. TSC or anyone on its behalf, assumes no responsibility or liability for any errors or inaccuracies.

Information contained herein is intended to provide a product description only. No license, express or implied, to any intellectual property rights is granted by this document. Except as provided in TSC's terms and conditions of sale for such products, TSC assumes no liability whatsoever, and disclaims any express or implied warranty, relating to sale and/or use of TSC products including liability or warranties relating to fitness for a particular purpose, merchantability, or infringement of any patent, copyright, or other intellectual property right.

The products shown herein are not designed for use in medical, life-saving, or life-sustaining applications. Customers using or selling these products for use in such applications do so at their own risk and agree to fully indemnify TSC for any damages resulting from such improper use or sale.

Looking for pricing, stock, or lifecycle information?

Click below to explore more details on WIN SOURCE:

- ⊖ [View TSM9933DCS RLG on WIN SOURCE](#)
- ⊖ [Taiwan Semiconductor](#) Information

Optimize Your Supply Chain with WIN SOURCE Solutions

- ✓ Global Sourcing Solution
- ✓ Obsolete Management
- ✓ Cost Control Management
- ✓ Shortage Management
- ✓ Alternative Solution
- ✓ Excess Inventory Management