



**THE DATASHEET OF  
SPP02N80C3XKSA1**



## CoolMOS™ Power Transistor

### Features

- New revolutionary high voltage technology
- Extreme dv/dt rated
- High peak current capability
- Qualified according to JEDEC<sup>1)</sup> for target applications
- Pb-free lead plating; RoHS compliant
- Ultra low gate charge
- Ultra low effective capacitances

### Product Summary

$V_{DS}$	800	V
$R_{DS(on)max}$ @ $T_j = 25^\circ\text{C}$	2.7	$\Omega$
$Q_{g,typ}$	12	nC

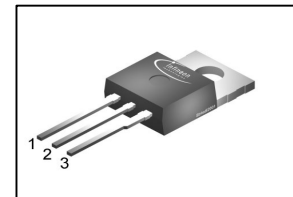
**PG-TO220-3**

### CoolMOS™ 800V designed for:

- Industrial application with high DC bulk voltage
- Switching Application ( i.e. active clamp forward )

Type	Package	Marking
SPP02N80C3	PG-TO220-3	02N80C3

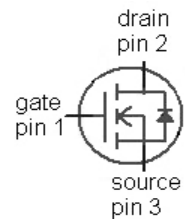

### Maximum ratings, at $T_j=25^\circ\text{C}$ , unless otherwise specified

Parameter	Symbol	Conditions	Value	Unit
Continuous drain current	$I_D$	$T_C=25^\circ\text{C}$	2	A
		$T_C=100^\circ\text{C}$	1.2	
Pulsed drain current <sup>2)</sup>	$I_{D,pulse}$	$T_C=25^\circ\text{C}$	6	
Avalanche energy, single pulse	$E_{AS}$	$I_D=1\text{ A}, V_{DD}=50\text{ V}$	90	mJ
Avalanche energy, repetitive $t_{AR}$ <sup>2),3)</sup>	$E_{AR}$	$I_D=2\text{ A}, V_{DD}=50\text{ V}$	0.05	
Avalanche current, repetitive $t_{AR}$ <sup>2),3)</sup>	$I_{AR}$		2	A
MOSFET dv/dt ruggedness	dv/dt	$V_{DS}=0\dots640\text{ V}$	50	V/ns
Gate source voltage	$V_{GS}$	static	$\pm 20$	V
		AC ( $f>1\text{ Hz}$ )	$\pm 30$	
Power dissipation	$P_{tot}$	$T_C=25^\circ\text{C}$	42	W
Operating and storage temperature	$T_j, T_{stg}$		-55 ... 150	$^\circ\text{C}$
Mounting torque		M3 and M3.5 screws	60	Ncm

Maximum ratings, at  $T_j=25\text{ °C}$ , unless otherwise specified

Parameter	Symbol	Conditions	Value	Unit
Continuous diode forward current	$I_S$	$T_C=25\text{ °C}$	2	A
Diode pulse current <sup>2)</sup>	$I_{S,pulse}$		6	
Reverse diode $dv/dt$ <sup>4)</sup>	$dv/dt$		4	V/ns

Parameter	Symbol	Conditions	Values			Unit
			min.	typ.	max.	

### Thermal characteristics

Thermal resistance, junction - case	$R_{thJC}$		-	-	3	K/W
Thermal resistance, junction - ambient	$R_{thJA}$	leaded	-	-	62	
Soldering temperature, wave soldering only allowed at leads	$T_{sold}$	1.6 mm (0.063 in.) from case for 10s	-	-	260	°C

Electrical characteristics, at  $T_j=25\text{ °C}$ , unless otherwise specified

### Static characteristics

Drain-source breakdown voltage	$V_{(BR)DSS}$	$V_{GS}=0\text{ V}$ , $I_D=250\text{ }\mu\text{A}$	800	-	-	V
Avalanche breakdown voltage	$V_{(BR)DS}$	$V_{GS}=0\text{ V}$ , $I_D=2\text{ A}$	-	870	-	
Gate threshold voltage	$V_{GS(th)}$	$V_{DS}=V_{GS}$ , $I_D=0.12\text{ mA}$	2.1	3	3.9	
Zero gate voltage drain current	$I_{DSS}$	$V_{DS}=800\text{ V}$ , $V_{GS}=0\text{ V}$ , $T_j=25\text{ °C}$	-	-	5	$\mu\text{A}$
		$V_{DS}=800\text{ V}$ , $V_{GS}=0\text{ V}$ , $T_j=150\text{ °C}$	-	25	-	
Gate-source leakage current	$I_{GSS}$	$V_{GS}=20\text{ V}$ , $V_{DS}=0\text{ V}$	-	-	100	nA
Drain-source on-state resistance	$R_{DS(on)}$	$V_{GS}=10\text{ V}$ , $I_D=1.2\text{ A}$ , $T_j=25\text{ °C}$	-	2.4	2.7	$\Omega$
		$V_{GS}=10\text{ V}$ , $I_D=1.2\text{ A}$ , $T_j=150\text{ °C}$	-	6.5	-	
Gate resistance	$R_G$	$f=1\text{ MHz}$ , open drain	-	1.2	-	$\Omega$

Parameter	Symbol	Conditions	Values			Unit
			min.	typ.	max.	

**Dynamic characteristics**

Input capacitance	$C_{iss}$	$V_{GS}=0\text{ V}, V_{DS}=100\text{ V},$	-	290	-	pF
Output capacitance	$C_{oss}$	$f=1\text{ MHz}$	-	13	-	
Effective output capacitance, energy related <sup>5)</sup>	$C_{o(er)}$	$V_{GS}=0\text{ V}, V_{DS}=0\text{ V}$ to 480 V	-	11	-	
Effective output capacitance, time related <sup>6)</sup>	$C_{o(tr)}$		-	26	-	
Turn-on delay time	$t_{d(on)}$	$V_{DD}=400\text{ V},$ $V_{GS}=0/10\text{ V}, I_D=2\text{ A},$ $R_G=47\text{ }\Omega, T_j=25\text{ }^\circ\text{C}$	-	25	-	ns
Rise time	$t_r$		-	15	-	
Turn-off delay time	$t_{d(off)}$		-	72	-	
Fall time	$t_f$		-	18	-	

**Gate Charge Characteristics**

Gate to source charge	$Q_{gs}$	$V_{DD}=640\text{ V}, I_D=2\text{ A},$ $V_{GS}=0\text{ to }10\text{ V}$	-	1.5	-	nC
Gate to drain charge	$Q_{gd}$		-	6	-	
Gate charge total	$Q_g$		-	12	16	
Gate plateau voltage	$V_{plateau}$		-	5.5	-	V

**Reverse Diode**

Diode forward voltage	$V_{SD}$	$V_{GS}=0\text{ V}, I_F=I_S=2\text{ A},$ $T_j=25\text{ }^\circ\text{C}$	-	1	1.2	V
Reverse recovery time	$t_{rr}$	$V_R=400\text{ V}, I_F=I_S=2\text{ A},$ $di_F/dt=100\text{ A}/\mu\text{s}$	-	520	-	ns
Reverse recovery charge	$Q_{rr}$		-	2	-	$\mu\text{C}$
Peak reverse recovery current	$I_{rrm}$		-	6	-	A

<sup>1)</sup> J-STD20 and JESD22

<sup>2)</sup> Pulse width  $t_p$  limited by  $T_{j,max}$

<sup>3)</sup> Repetitive avalanche causes additional power losses that can be calculated as  $P_{AV}=E_{AR} \cdot f$ .

<sup>4)</sup>  $I_{SD}=I_D, di/dt=400\text{ A}/\mu\text{s}, V_{DClink}=400\text{ V}, V_{peak}<V_{(BR)DSS}, T_j<T_{j,max}$ , identical low side and high side switch

<sup>5)</sup>  $C_{o(er)}$  is a fixed capacitance that gives the same stored energy as  $C_{oss}$  while  $V_{DS}$  is rising from 0 to 80%  $V_{DSS}$ .

<sup>6)</sup>  $C_{o(tr)}$  is a fixed capacitance that gives the same charging time as  $C_{oss}$  while  $V_{DS}$  is rising from 0 to 80%  $V_{DSS}$ .

### 1 Power dissipation

$$P_{tot} = f(T_C)$$

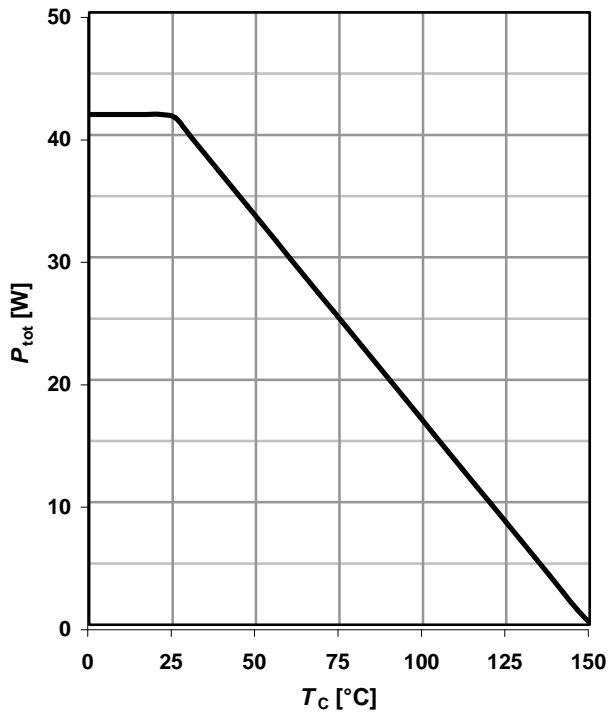

### 2 Safe operating area

$$I_D = f(V_{DS}); T_C = 25^\circ\text{C}; D = 0$$

parameter:  $t_p$

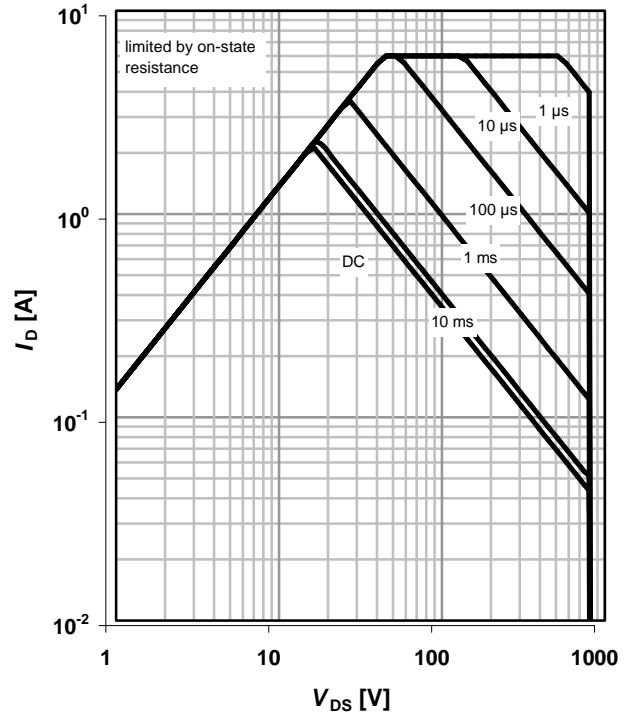

### 3 Max. transient thermal impedance

$$Z_{thJC} = f(t_p)$$

parameter:  $D = t_p / T$

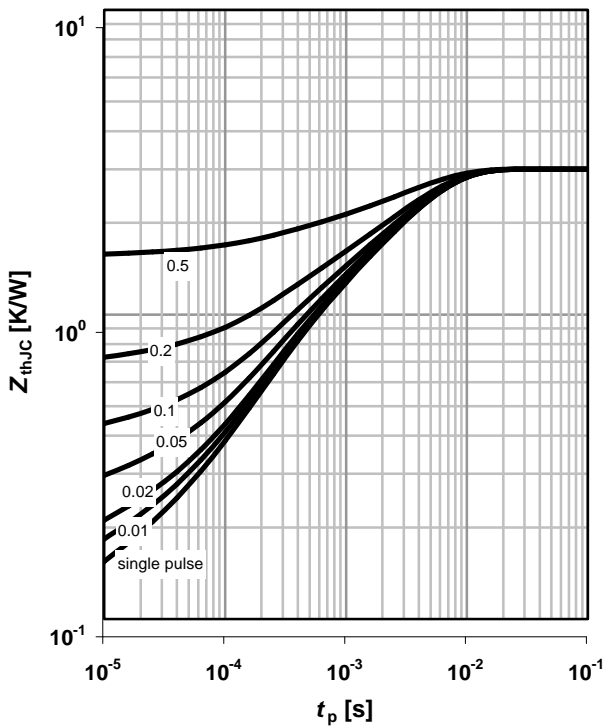

### 4 Typ. output characteristics

$$I_D = f(V_{DS}); T_j = 25^\circ\text{C}; t_p = 10 \mu\text{s}$$

parameter:  $V_{GS}$

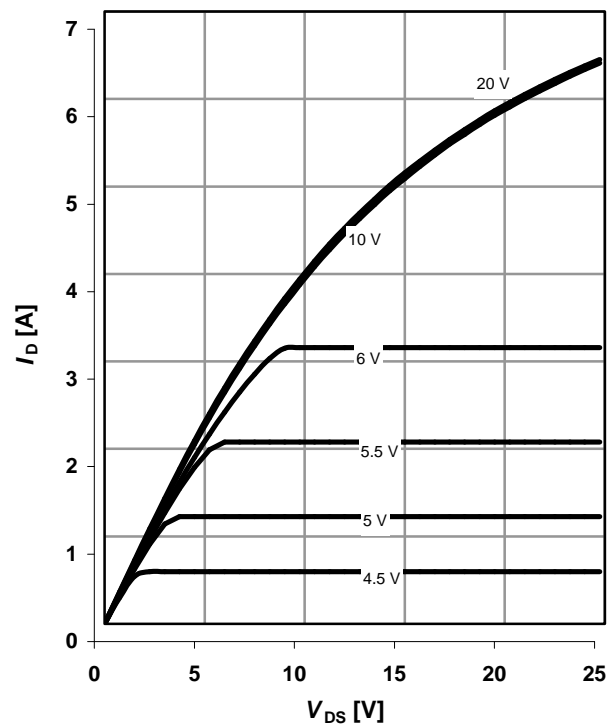

**5 Typ. output characteristics**

$I_D=f(V_{DS}); T_j=150\text{ °C}; t_p=10\text{ }\mu\text{s}$

parameter:  $V_{GS}$

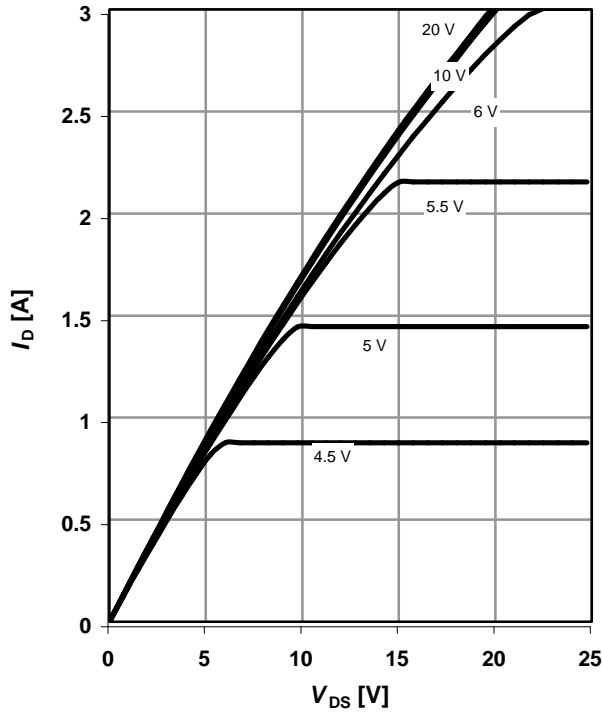

**6 Typ. drain-source on-state resistance**

$R_{DS(on)}=f(I_D); T_j=150\text{ °C}$

parameter:  $V_{GS}$

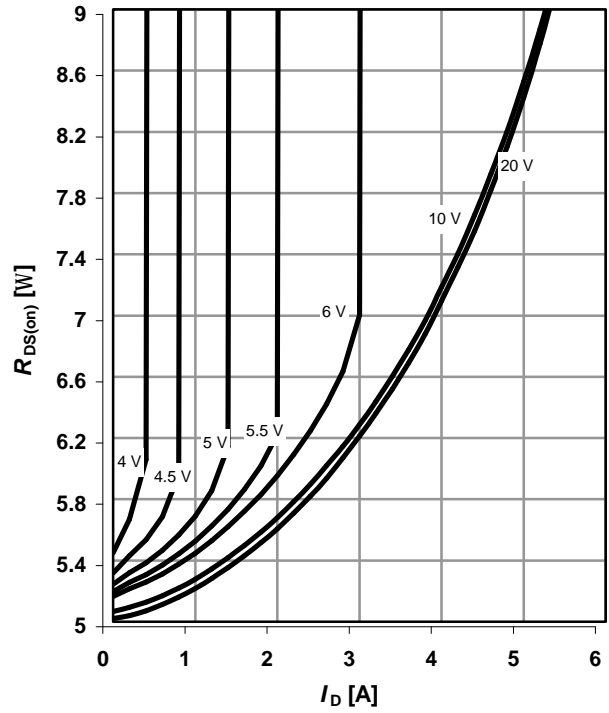

**7 Drain-source on-state resistance**

$R_{DS(on)}=f(T_j); I_D=1.2\text{ A}; V_{GS}=10\text{ V}$

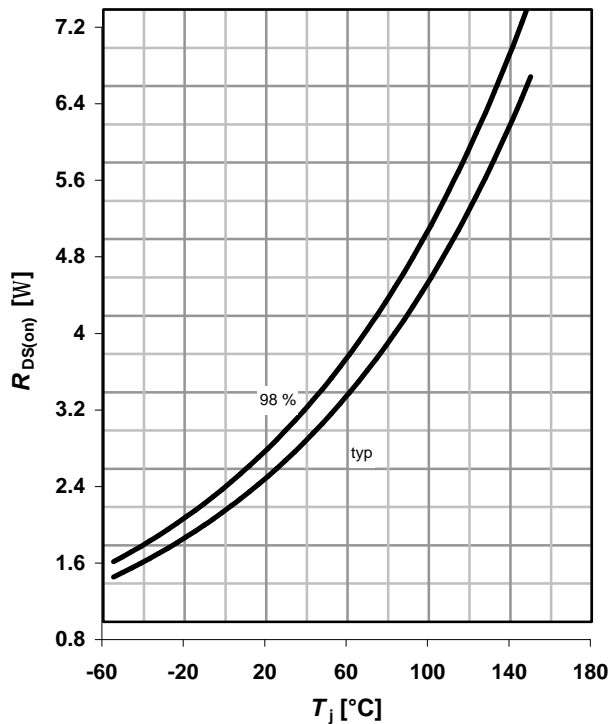

**8 Typ. transfer characteristics**

$I_D=f(V_{GS}); |V_{DS}|>2|I_D|R_{DS(on)max}; t_p=10\text{ }\mu\text{s}$

parameter:  $T_j$

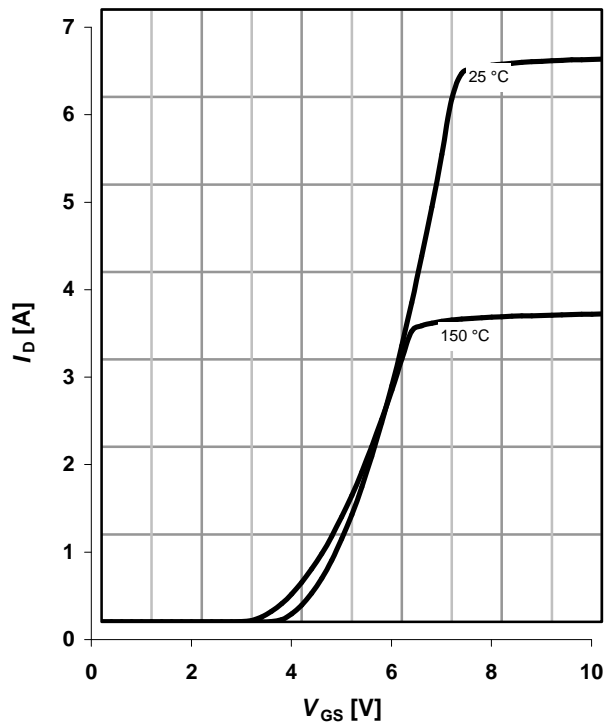

**9 Typ. gate charge**

$V_{GS}=f(Q_{gate}); I_D=2\text{ A}$  pulsed

parameter:  $V_{DD}$

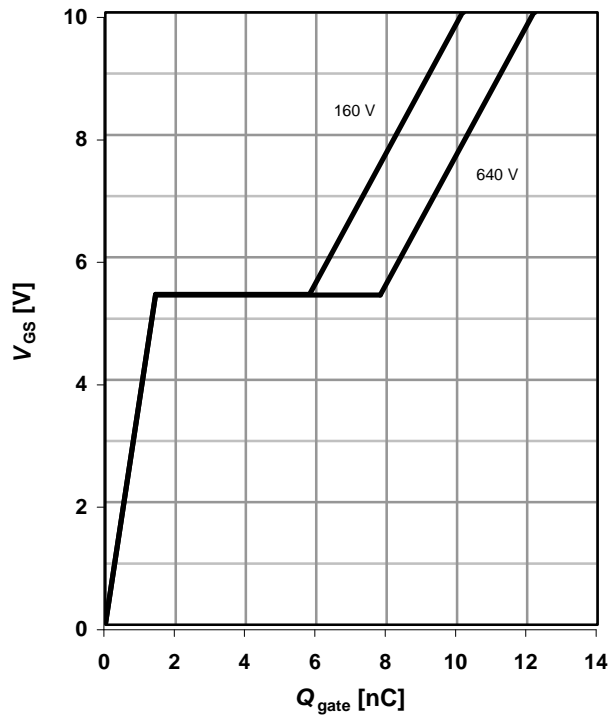

**10 Forward characteristics of reverse diode**

$I_F=f(V_{SD}); t_p=10\ \mu s$

parameter:  $T_j$

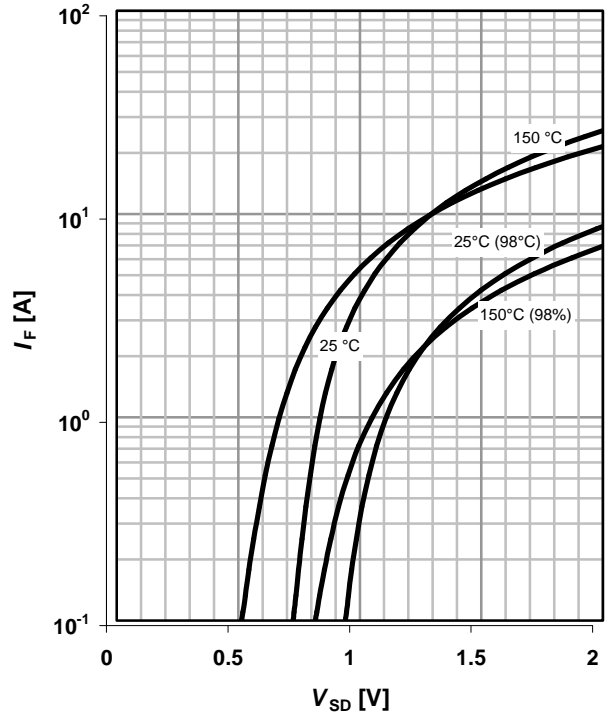

**11 Avalanche energy**

$E_{AS}=f(T_j); I_D=1\text{ A}; V_{DD}=50\text{ V}$

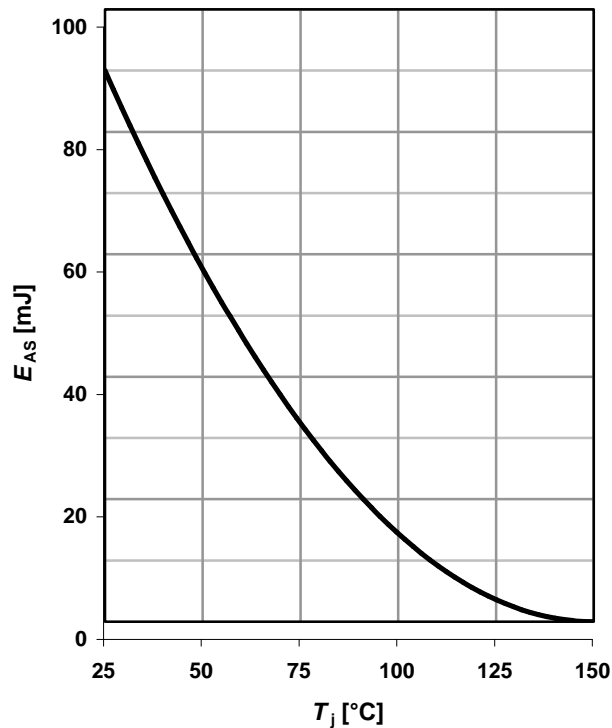

**12 Drain-source breakdown voltage**

$V_{BR(DSS)}=f(T_j); I_D=0.25\text{ mA}$

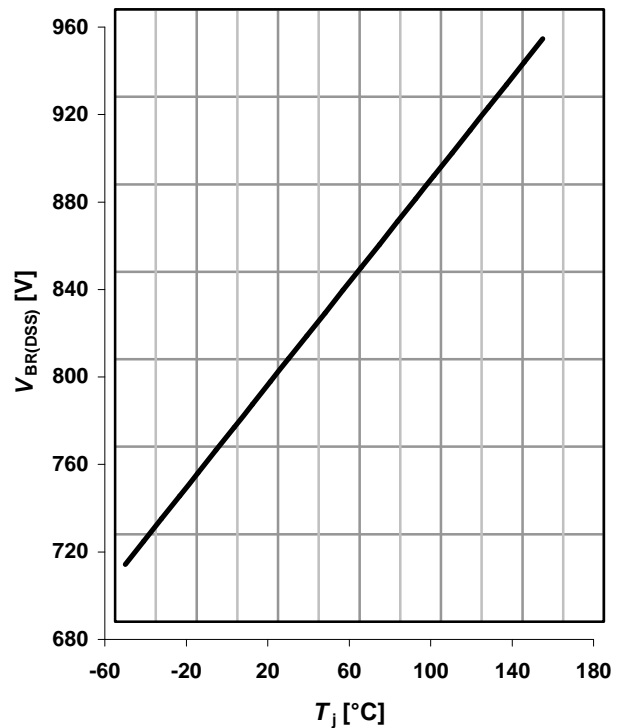

**13 Typ. capacitances**

$C=f(V_{DS}); V_{GS}=0\text{ V}; f=1\text{ MHz}$

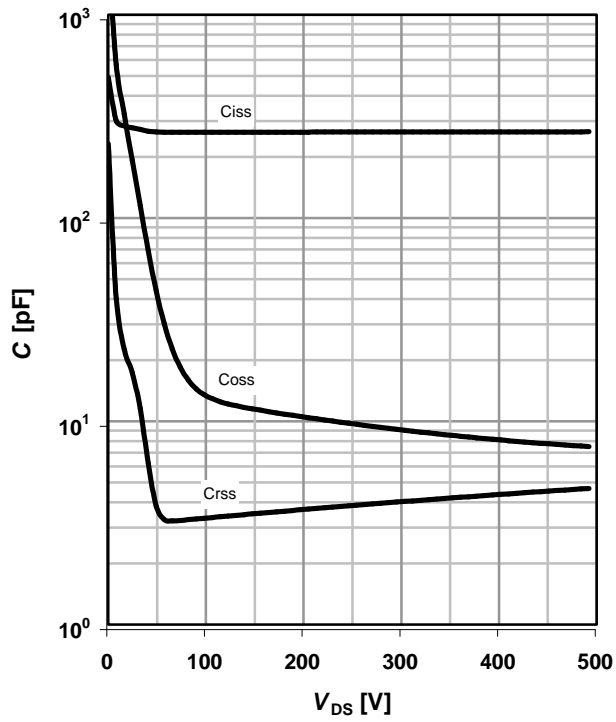

**14 Typ. Coss stored energy**

$E_{oss}=f(V_{DS})$

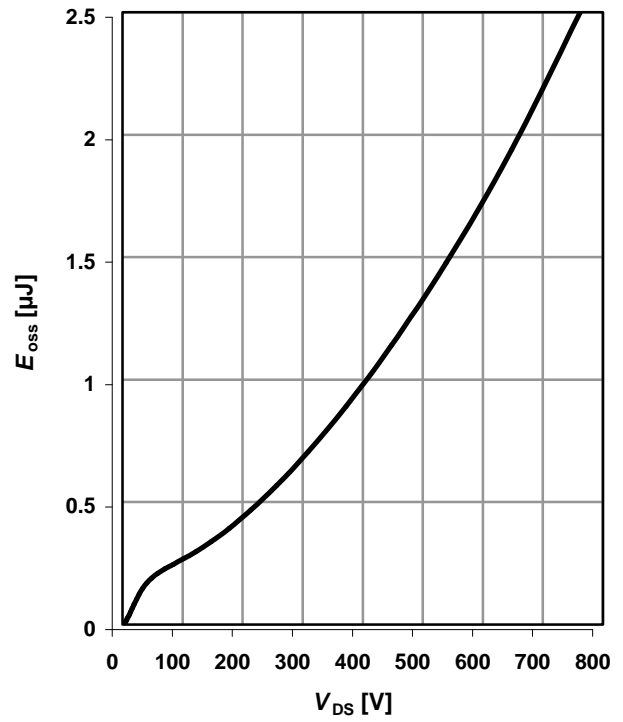

Definition of diode switching characteristics

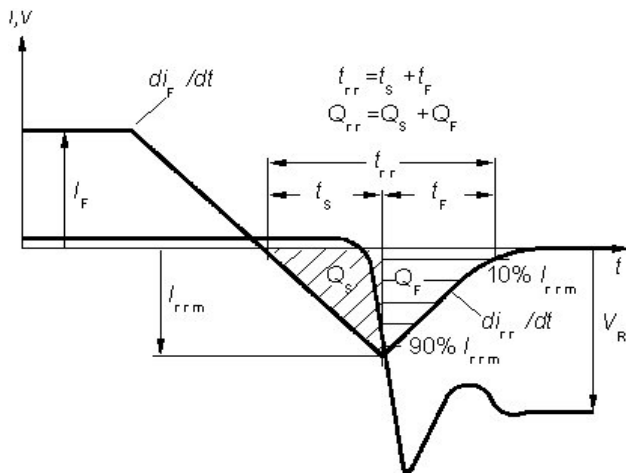

PG-TO220-3: Outline

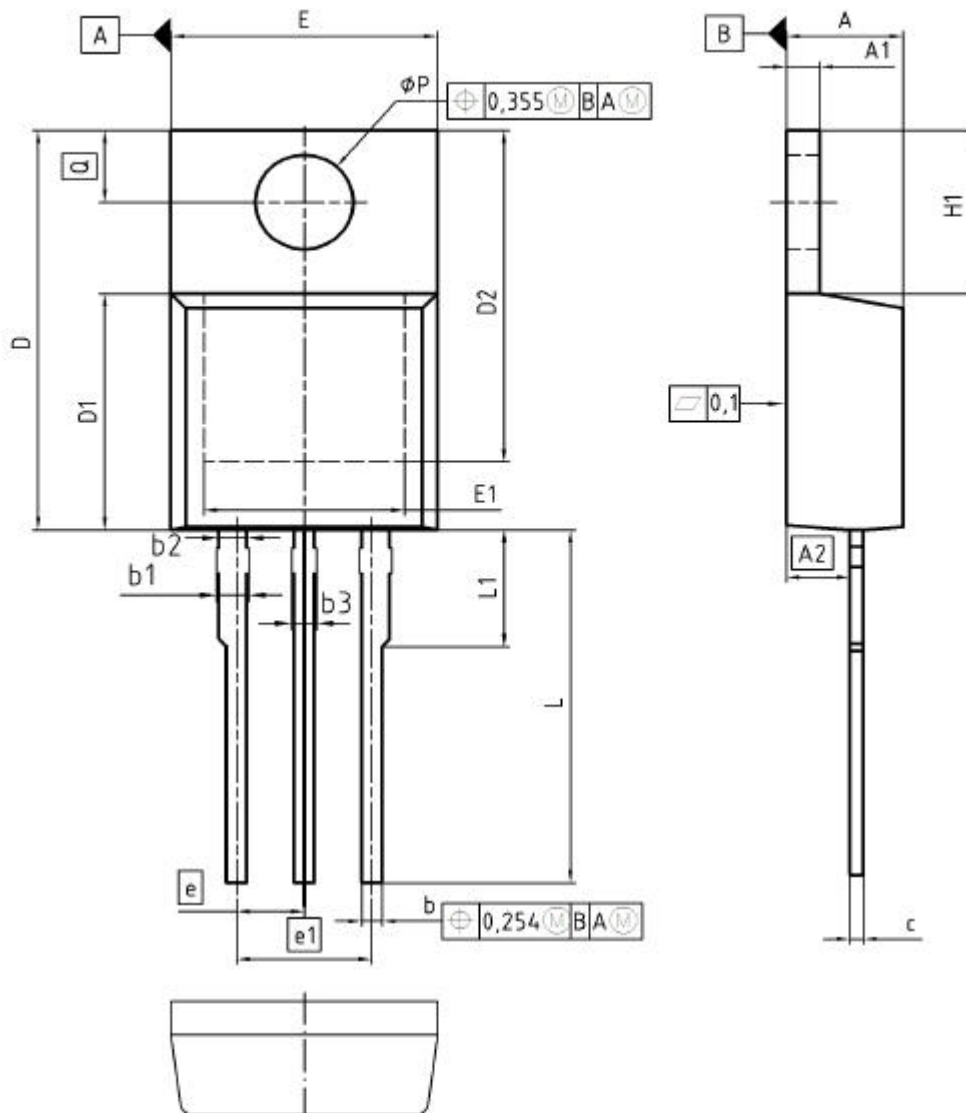

DIM	MILLIMETERS		INCHES	
	MIN	MAX	MIN	MAX
A	4.30	4.57	0.169	0.180
A1	1.17	1.40	0.046	0.055
A2	2.15	2.72	0.085	0.107
b	0.65	0.86	0.026	0.034
b1	0.95	1.40	0.037	0.055
b2	0.95	1.15	0.037	0.045
b3	0.65	1.15	0.026	0.045
c	0.33	0.60	0.013	0.024
D	14.81	15.95	0.583	0.628
D1	8.51	9.45	0.335	0.372
D2	12.19	13.10	0.480	0.516
E	9.70	10.36	0.382	0.408
E1	6.50	8.60	0.256	0.339
e	2.54		0.100	
e1	5.08		0.200	
N	3		3	
H1	5.90	6.90	0.232	0.272
L	13.00	14.00	0.512	0.551
L1	-	4.80	-	0.189
$\phi P$	3.60	3.89	0.142	0.153
Q	2.60	3.00	0.102	0.118

DOCUMENT NO.  
Z8B00003318

SCALE

EUROPEAN PROJECTION

ISSUE DATE  
23-08-2007

REVISION  
05

**Published by**  
**Infineon Technologies AG**  
**81726 Munich, Germany**  
**© 2008 Infineon Technologies AG**  
**All Rights Reserved.**

**Legal Disclaimer**

The information given in this document shall in no event be regarded as a guarantee of conditions or characteristics. With respect to any examples or hints given herein, any typical values stated herein and/or any information regarding the application of the device, Infineon Technologies hereby disclaims any and all warranties and liabilities of any kind, including without limitation, warranties of non-infringement of intellectual property rights of any third party.

**Information**



For further information on technology, delivery terms and conditions and prices, please [contact the nearest Infineon Technologies Office \(www.infineon.com\)](http://www.infineon.com).

**Warnings**

Due to technical requirements, components may contain dangerous substances. For information on the types in question, please contact the nearest Infineon Technologies Office. Infineon Technologies components may be used in life-support devices or systems only with the express written approval of Infineon Technologies, if a failure of such components can reasonably be expected to cause the failure of that life-support device or system or to affect the safety or effectiveness of that device or system. Life support devices or systems are intended to be implanted in the human body or to support and/or maintain and sustain and/or protect human life. If they fail, it is reasonable to assume that the health of the user or other persons may be endangered.

## Looking for pricing, stock, or lifecycle information?

Click below to explore more details on WIN SOURCE:

-  [View SPP02N80C3XKSA1 on WIN SOURCE](#)
-  [Infineon Technologies Information](#)

## Optimize Your Supply Chain with WIN SOURCE Solutions

-  Global Sourcing Solution
-  Obsolete Management
-  Cost Control Management
-  Shortage Management
-  Alternative Solution
-  Excess Inventory Management