



# THE DATASHEET OF INA211BIRSWT



## INA21x Voltage Output, Low- or High-Side Measurement, Bidirectional, Zero-Drift Series, Current-Shunt Monitors

### 1 Features

- Wide Common-Mode Range:  $-0.3\text{ V}$  to  $26\text{ V}$
- Offset Voltage:  $\pm 35\ \mu\text{V}$  (Maximum, INA210)  
(Enables Shunt Drops of 10-mV Full-Scale)
- Accuracy:
  - Gain Error (Maximum Over Temperature):
    - $\pm 0.5\%$  (Version C)
    - $\pm 1\%$  (Versions A and B)
  - $0.5\text{-}\mu\text{V}/^\circ\text{C}$  Offset Drift (Maximum)
  - $10\text{-ppm}/^\circ\text{C}$  Gain Drift (Maximum)
- Choice of Gains:
  - INA210: 200 V/V
  - INA211: 500 V/V
  - INA212: 1000 V/V
  - INA213: 50 V/V
  - INA214: 100 V/V
  - INA215: 75 V/V
- Quiescent Current:  $100\ \mu\text{A}$  (Maximum)
- SC70 and Thin UQFN Packages: All Models

### 2 Applications

- Notebook Computers
- Cell Phones
- Telecom Equipment
- Power Management
- Battery Chargers

### 3 Description

The INA21x are voltage-output, current-shunt monitors (also called current-sense amplifiers) that are commonly used for overcurrent protection, precision-current measurement for system optimization, or in closed-loop feedback circuits. This series of devices can sense drops across shunts at common-mode voltages from  $-0.3\text{ V}$  to  $26\text{ V}$ , independent of the supply voltage. Six fixed gains are available: 50 V/V, 75 V/V, 100 V/V, 200 V/V, 500 V/V, or 1000 V/V. The low offset of the zero-drift architecture enables current sensing with maximum drops across the shunt as low as 10-mV full-scale.

These devices operate from a single 2.7-V to 26-V power supply, drawing a maximum of  $100\ \mu\text{A}$  of supply current. All versions are specified over the extended operating temperature range ( $-40^\circ\text{C}$  to  $+125^\circ\text{C}$ ), and offered in SC70 and UQFN packages.

#### Device Information<sup>(1)</sup>

PART NUMBER	PACKAGE	BODY SIZE (NOM)
INA21x	SC70 (6)	2.00 mm x 1.25 mm
	UQFN (10)	1.80 mm x 1.40 mm

(1) For all available packages, see the orderable addendum at the end of the data sheet.

#### Simplified Schematic



$$V_{\text{OUT}} = (I_{\text{LOAD}} \times R_{\text{SHUNT}}) \text{ Gain} + V_{\text{REF}}$$

Copyright © 2017, Texas Instruments Incorporated



## Table of Contents

<b>1 Features</b> .....	<b>1</b>	<b>8 Application and Implementation</b> .....	<b>22</b>
<b>2 Applications</b> .....	<b>1</b>	8.1 Application Information.....	22
<b>3 Description</b> .....	<b>1</b>	8.2 Typical Applications .....	22
<b>4 Revision History</b> .....	<b>2</b>	<b>9 Power Supply Recommendations</b> .....	<b>25</b>
<b>5 Pin Configurations and Functions</b> .....	<b>5</b>	<b>10 Layout</b> .....	<b>25</b>
<b>6 Specifications</b> .....	<b>6</b>	10.1 Layout Guidelines .....	25
6.1 Absolute Maximum Ratings .....	6	10.2 Layout Example .....	26
6.2 ESD Ratings.....	6	<b>11 Device and Documentation Support</b> .....	<b>27</b>
6.3 Recommended Operating Conditions.....	6	11.1 Documentation Support .....	27
6.4 Thermal Information .....	7	11.2 Related Links .....	27
6.5 Electrical Characteristics.....	8	11.3 Receiving Notification of Documentation Updates	27
6.6 Typical Characteristics .....	10	11.4 Community Resources.....	27
<b>7 Detailed Description</b> .....	<b>14</b>	11.5 Trademarks .....	27
7.1 Overview .....	14	11.6 Electrostatic Discharge Caution.....	27
7.2 Functional Block Diagram .....	14	11.7 Glossary .....	27
7.3 Feature Description.....	15	<b>12 Mechanical, Packaging, and Orderable</b>	
7.4 Device Functional Modes.....	16	<b>Information</b> .....	<b>28</b>

## 4 Revision History

NOTE: Page numbers for previous revisions may differ from page numbers in the current version.

<b>Changes from Revision I (September 2016) to Revision J</b>	<b>Page</b>
• Added 2017 copyright to front page graphic .....	1
• Deleted <i>Device Options</i> table .....	5
• Added Common-mode analog inputs (Versions B and C) to <i>Absolute Maximum Ratings</i> table .....	6
• Changed HBM ESD value (Version A) from 4000 to 2000 V in <i>ESD Ratings</i> table .....	6
• Changed formatting of <i>Thermal Information</i> table note.....	7
• Deleted static literature number from document reference in <i>Related Documentation</i> section .....	27

<b>Changes from Revision H (June 2016) to Revision I</b>	<b>Page</b>
• Deleted all notes regarding preview devices throughout data sheet; all devices now active.....	1

<b>Changes from Revision G (July 2014) to Revision H</b>	<b>Page</b>
• Changed Features section: deleted last bullet, changed packages bullet .....	1
• Deleted last <i>Applications</i> bullet .....	1
• Changed <i>Description</i> section.....	1
• Changed <i>Device Information</i> table .....	1
• Moved storage temperature to <i>Absolute Maximum Ratings</i> table .....	6
• Changed <i>ESD Ratings</i> table: changed title, changed format to current standards .....	6
• Deleted both <i>Machine Model</i> rows from <i>ESD Ratings</i> table .....	6
• Changed first sentence referencing <a href="#">Equation 1</a> in <i>Input Filtering</i> section: replaced <i>seen</i> with <i>measured</i> .....	16
• Changed second sentence referencing <a href="#">Equation 1</a> in <i>Input Filtering</i> section .....	17
• Corrected punctuation and added clarity to first and second paragraphs in <i>Shutting Down the INA21x Series</i> section ....	18
• Changed <i>impressed</i> to <i>present</i> in fourth paragraph of <i>Shutting Down the INA21x Series</i> section .....	18

---

**Changes from Revision F (June 2014) to Revision G** **Page**

---

- Changed Simplified Schematic: added equation below gain table..... 1
  - Changed  $V_{(ESD)}$  HBM specifications for version A in Handling Ratings table..... 6
- 

**Changes from Revision E (June 2013) to Revision F** **Page**

---

- Changed format to meet latest data sheet standards; added Pin Functions, Recommended Operating Conditions, and Thermal Information tables, *Overview*, *Functional Block Diagram*, *Application Information*, *Power Supply Recommendations*, and *Layout* sections, and moved existing sections ..... 1
  - Added INA215 to document ..... 1
  - Added INA215 sub-bullet to fourth Features bullet ..... 1
  - Added INA215 to simplified schematic table ..... 1
  - Added Thermal Information table ..... 6
  - Added INA215 to [Figure 7](#) ..... 10
  - Added INA215 to [Figure 15](#) ..... 11
  - Added INA215 to [Figure 25](#) ..... 18
- 

**Changes from Revision D (November 2012) to Revision E** **Page**

---

**Changes from Revision C (August 2012) to Revision D** **Page**

---

- Changed Frequency Response, *Bandwidth* parameter in Electrical Characteristics table ..... 6
- 

**Changes from Revision B (June 2009) to Revision C** **Page**

---

- Added silicon version B row to Input, *Common-Mode Input Range* parameter in Electrical Characteristics table..... 6
  - Added silicon version B ESD ratings to Abs Max table..... 6
  - Corrected typo in [Figure 9](#) ..... 10
  - Updated [Figure 12](#) ..... 10
  - Changed *Input Filtering* section..... 16
  - Added *Improving Transient Robustness* section ..... 21
- 

**Changes from Revision A (June 2008) to Revision B** **Page**

---

- Added RSW package to device photo..... 1
  - Added UQFN package to *Features* list..... 1
  - Updated front page graphic..... 1
  - Added RSW package pin out drawing..... 5
  - Added footnote 3 to *Electrical Characteristics* table..... 6
  - Added UQFN package information to *Temperature Range* section of *Electrical Characteristics* table ..... 6
  - Changed [Figure 2](#) to reflect operating temperature range ..... 10
  - Changed [Figure 4](#) to reflect operating temperature range ..... 10
  - Changed [Figure 6](#) to reflect operating temperature range ..... 10
  - Changed [Figure 13](#) to reflect operating temperature range ..... 11
  - Changed [Figure 14](#) to reflect operating temperature range ..... 11
  - Added RSW description to the [Basic Connections](#) section..... 15
  - Changed 60  $\mu$ V to 100  $\mu$ V in last sentence of the [Selecting RS](#) section ..... 15
-

---

Changes from Original (May 2008) to Revision A	Page
• Deleted first footnote of <i>Electrical Characteristics</i> table .....	6
• Changed <a href="#">Figure 7</a> .....	10
• Changed <a href="#">Figure 15</a> .....	11

---

## 5 Pin Configurations and Functions

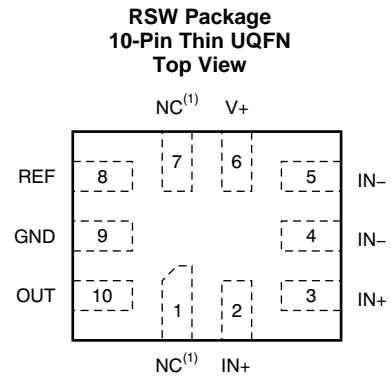
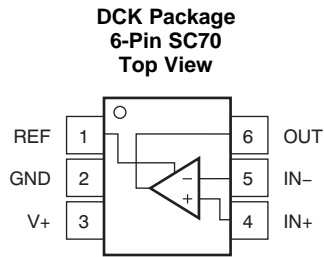

- (1) NC denotes no internal connection. These pins can be left floating or connected to any voltage between V- and V+.

### Pin Functions

PIN			I/O	DESCRIPTION
NAME	DCK	RSW		
GND	2	9	Analog	Ground
IN-	5	4, 5	Analog input	Connect to load side of shunt resistor
IN+	4	2, 3	Analog input	Connect to supply side of shunt resistor
NC	—	1, 7	—	Not internally connected. Leave floating or connect to ground.
OUT	6	10	Analog output	Output voltage
REF	1	8	Analog input	Reference voltage, 0 V to V+
V+	3	6	Analog	Power supply, 2.7 V to 26 V

## 6 Specifications

### 6.1 Absolute Maximum Ratings

 over operating free-air temperature range (unless otherwise noted)<sup>(1)</sup>

		MIN	MAX	UNIT
Supply voltage, $V_S$			26	V
Analog inputs, $V_{IN+}$ , $V_{IN-}$ <sup>(2)</sup>	Differential ( $V_{IN+} - V_{IN-}$ )	-26	26	V
	Common-mode (Version A) <sup>(3)</sup>	GND - 0.3	26	V
	Common-mode (Version B) <sup>(3)</sup>	GND - 0.1	26	V
	Common-mode (Version C) <sup>(3)</sup>	GND - 0.1	26	V
REF input		GND - 0.3	$(V_S) + 0.3$	V
Output <sup>(3)</sup>		GND - 0.3	$(V_S) + 0.3$	V
Input current into any terminal <sup>(3)</sup>			5	mA
Operating temperature		-55	150	°C
Junction temperature			150	°C
Storage temperature, $T_{stg}$		-65	150	°C

(1) Stresses beyond those listed under *Absolute Maximum Ratings* may cause permanent damage to the device. These are stress ratings only, which do not imply functional operation of the device at these or any other conditions beyond those indicated under *Recommended Operating Conditions*. Exposure to absolute-maximum-rated conditions for extended periods may affect device reliability.

(2)  $V_{IN+}$  and  $V_{IN-}$  are the voltages at the IN+ and IN- pins, respectively.

(3) Input voltage at any terminal may exceed the voltage shown if the current at that pin is limited to 5 mA.

### 6.2 ESD Ratings

			VALUE	UNIT
<b>INA21x, (VERSION A)</b>				
$V_{(ESD)}$	Electrostatic discharge	Human-body model (HBM), per ANSI/ESDA/JEDEC JS-001 <sup>(1)</sup>	±2000	V
		Charged-device model (CDM), per JEDEC specification JESD22-C101 <sup>(2)</sup>	±1000	
<b>INA21x, (VERSIONS B AND C)</b>				
$V_{(ESD)}$	Electrostatic discharge	Human-body model (HBM), per ANSI/ESDA/JEDEC JS-001 <sup>(1)</sup>	±3500	V
		Charged-device model (CDM), per JEDEC specification JESD22-C101 <sup>(2)</sup>	±1000	

(1) JEDEC document JEP155 states that 500-V HBM allows safe manufacturing with a standard ESD control process.

(2) JEDEC document JEP157 states that 250-V CDM allows safe manufacturing with a standard ESD control process.

### 6.3 Recommended Operating Conditions

over operating free-air temperature range (unless otherwise noted)

		MIN	NOM	MAX	UNIT
$V_{CM}$	Common-mode input voltage		12		V
$V_S$	Operating supply voltage		5		V
$T_A$	Operating free-air temperature	-40		125	°C

## 6.4 Thermal Information

THERMAL METRIC <sup>(1)</sup>		INA21x		UNIT
		DCK (SC70)	RSW (UQFN)	
		6 PINS	10 PINS	
$R_{\theta JA}$	Junction-to-ambient thermal resistance	227.3	107.3	°C/W
$R_{\theta JC(top)}$	Junction-to-case (top) thermal resistance	79.5	56.5	°C/W
$R_{\theta JB}$	Junction-to-board thermal resistance	72.1	18.7	°C/W
$\Psi_{JT}$	Junction-to-top characterization parameter	3.6	1.1	°C/W
$\Psi_{JB}$	Junction-to-board characterization parameter	70.4	18.7	°C/W
$R_{\theta JC(bot)}$	Junction-to-case (bottom) thermal resistance	N/A	N/A	°C/W

(1) For more information about traditional and new thermal metrics, see the [Semiconductor and IC Package Thermal Metrics](#) application report.

## 6.5 Electrical Characteristics

 at  $T_A = 25^\circ\text{C}$ ,  $V_{\text{SENSE}} = V_{\text{IN}+} - V_{\text{IN}-}$ 

 INA210, INA213, INA214, and INA215:  $V_S = 5\text{ V}$ ,  $V_{\text{IN}+} = 12\text{ V}$ , and  $V_{\text{REF}} = V_S / 2$ , unless otherwise noted

 INA211 and INA212:  $V_S = 12\text{ V}$ ,  $V_{\text{IN}+} = 12\text{ V}$ , and  $V_{\text{REF}} = V_S / 2$ , unless otherwise noted

PARAMETER		TEST CONDITIONS	MIN	TYP	MAX	UNIT
<b>INPUT</b>						
$V_{\text{CM}}$	Common-mode input range	Version A $T_A = -40^\circ\text{C}$ to $+125^\circ\text{C}$	-0.3		26	V
		Versions B and C $T_A = -40^\circ\text{C}$ to $+125^\circ\text{C}$	-0.1		26	
CMRR	Common-mode rejection ratio	INA210, INA211, INA212, INA214, INA215 $V_{\text{IN}+} = 0\text{ V}$ to $26\text{ V}$ $V_{\text{SENSE}} = 0\text{ mV}$ $T_A = -40^\circ\text{C}$ to $+125^\circ\text{C}$	105	140		dB
		INA213 $V_{\text{IN}+} = 0\text{ V}$ to $26\text{ V}$ $V_{\text{SENSE}} = 0\text{ mV}$ $T_A = -40^\circ\text{C}$ to $+125^\circ\text{C}$	100	120		
$V_{\text{O}}$	Offset voltage, RTI <sup>(1)</sup>	INA210, INA211, INA212 $V_{\text{SENSE}} = 0\text{ mV}$		$\pm 0.55$	$\pm 35$	$\mu\text{V}$
		INA213 $V_{\text{SENSE}} = 0\text{ mV}$		$\pm 5$	$\pm 100$	
		INA214, INA215 $V_{\text{SENSE}} = 0\text{ mV}$		$\pm 1$	$\pm 60$	
$dV_{\text{OS}}/dT$	RTI vs temperature	$V_{\text{SENSE}} = 0\text{ mV}$ $T_A = -40^\circ\text{C}$ to $+125^\circ\text{C}$		0.1	0.5	$\mu\text{V}/^\circ\text{C}$
PSRR	RTI vs power supply ratio	$V_S = 2.7\text{ V}$ to $18\text{ V}$ $V_{\text{IN}+} = 18\text{ V}$ $V_{\text{SENSE}} = 0\text{ mV}$		$\pm 0.1$	$\pm 10$	$\mu\text{V}/\text{V}$
$I_{\text{IB}}$	Input bias current	$V_{\text{SENSE}} = 0\text{ mV}$	15	28	35	$\mu\text{A}$
$I_{\text{IO}}$	Input offset current	$V_{\text{SENSE}} = 0\text{ mV}$		$\pm 0.02$		$\mu\text{A}$
<b>OUTPUT</b>						
G	Gain	INA210			200	V/V
		INA211			500	
		INA212			1000	
		INA213			50	
		INA214			100	
		INA215			75	
$E_{\text{G}}$	Gain error	$V_{\text{SENSE}} = -5\text{ mV}$ to $5\text{ mV}$ $T_A = -40^\circ\text{C}$ to $+125^\circ\text{C}$ (Versions A and B)		$\pm 0.02\%$	$\pm 1\%$	
		$V_{\text{SENSE}} = -5\text{ mV}$ to $5\text{ mV}$ $T_A = -40^\circ\text{C}$ to $+125^\circ\text{C}$ (Version C)		$\pm 0.02\%$	$\pm 0.5\%$	
	Gain error vs temperature	$T_A = -40^\circ\text{C}$ to $+125^\circ\text{C}$		3	10	ppm/ $^\circ\text{C}$
	Nonlinearity error	$V_{\text{SENSE}} = -5\text{ mV}$ to $5\text{ mV}$		$\pm 0.01\%$		
	Maximum capacitive load	No sustained oscillation		1		nF
<b>VOLTAGE OUTPUT<sup>(2)</sup></b>						
	Swing to V+ power-supply rail	$R_L = 10\text{ k}\Omega$ to GND $T_A = -40^\circ\text{C}$ to $+125^\circ\text{C}$		$(V_+) - 0.05$	$(V_+) - 0.2$	V
	Swing to GND	$R_L = 10\text{ k}\Omega$ to GND $T_A = -40^\circ\text{C}$ to $+125^\circ\text{C}$		$(V_{\text{GND}}) + 0.005$	$(V_{\text{GND}}) + 0.05$	V
<b>FREQUENCY RESPONSE</b>						
BW	Bandwidth	$C_{\text{LOAD}} = 10\text{ pF}$ , INA210		14		kHz
		$C_{\text{LOAD}} = 10\text{ pF}$ , INA211		7		
		$C_{\text{LOAD}} = 10\text{ pF}$ , INA212		4		
		$C_{\text{LOAD}} = 10\text{ pF}$ , INA213		80		
		$C_{\text{LOAD}} = 10\text{ pF}$ , INA214		30		
		$C_{\text{LOAD}} = 10\text{ pF}$ , INA215		40		
SR	Slew rate			0.4		V/ $\mu\text{s}$
<b>NOISE, RTI<sup>(1)</sup></b>						
	Voltage noise density			25		nV/ $\sqrt{\text{Hz}}$

(1) RTI = referred-to-input.

 (2) See Typical Characteristic curve, *Output Voltage Swing vs Output Current* (Figure 10).

## Electrical Characteristics (continued)

 at  $T_A = 25^\circ\text{C}$ ,  $V_{\text{SENSE}} = V_{\text{IN+}} - V_{\text{IN-}}$ 

 INA210, INA213, INA214, and INA215:  $V_S = 5\text{ V}$ ,  $V_{\text{IN+}} = 12\text{ V}$ , and  $V_{\text{REF}} = V_S / 2$ , unless otherwise noted

 INA211 and INA212:  $V_S = 12\text{ V}$ ,  $V_{\text{IN+}} = 12\text{ V}$ , and  $V_{\text{REF}} = V_S / 2$ , unless otherwise noted

PARAMETER		TEST CONDITIONS	MIN	TYP	MAX	UNIT
<b>POWER SUPPLY</b>						
$V_S$	Operating voltage range	$T_A = -40^\circ\text{C}$ to $+125^\circ\text{C}$	2.7		26	V
$I_Q$	Quiescent current	$V_{\text{SENSE}} = 0\text{ mV}$		65	100	$\mu\text{A}$
	$I_Q$ over temperature	$T_A = -40^\circ\text{C}$ to $+125^\circ\text{C}$			115	$\mu\text{A}$
<b>TEMPERATURE RANGE</b>						
	Specified range		-40		125	$^\circ\text{C}$
	Operating range		-55		150	$^\circ\text{C}$
$\theta_{JA}$	Thermal resistance	SC70		250		$^\circ\text{C}/\text{W}$
		Thin UQFN		80		$^\circ\text{C}/\text{W}$

## 6.6 Typical Characteristics

The INA210 is used for typical characteristics at  $T_A = 25^\circ\text{C}$ ,  $V_S = 5\text{ V}$ ,  $V_{IN+} = 12\text{ V}$ , and  $V_{REF} = V_S / 2$ , unless otherwise noted.

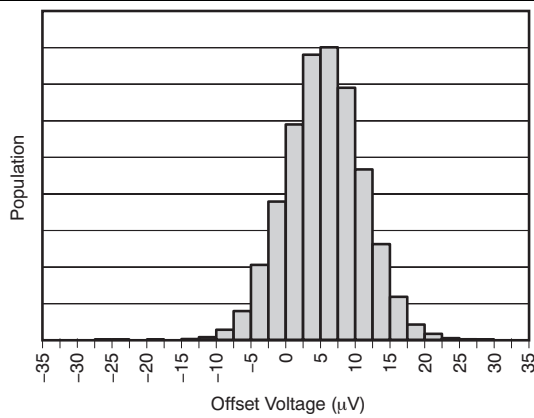

Figure 1. Input Offset Voltage Production Distribution

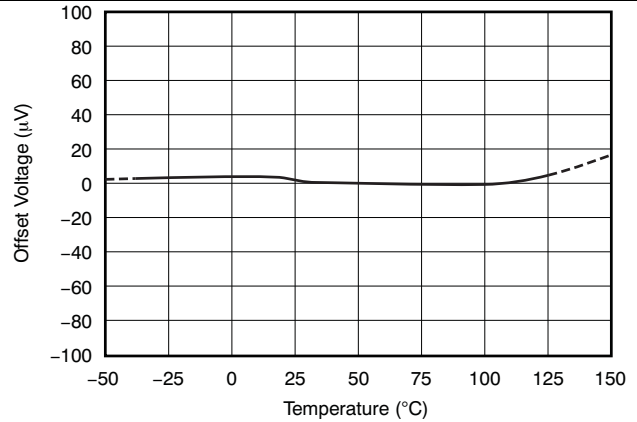

Figure 2. Offset Voltage vs Temperature

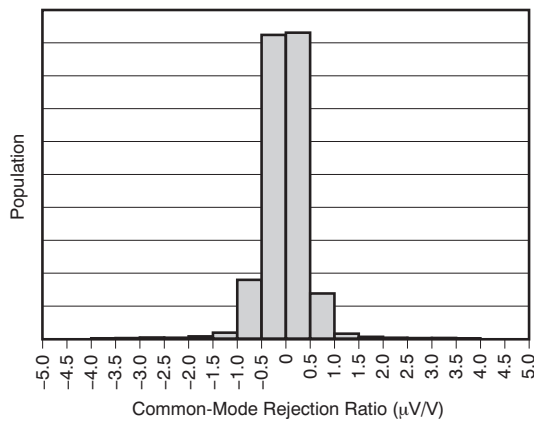

Figure 3. Common-Mode Rejection Production Distribution

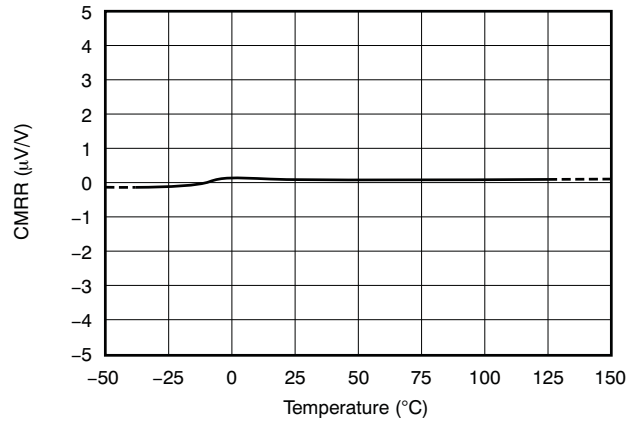

Figure 4. Common-Mode Rejection Ratio vs Temperature

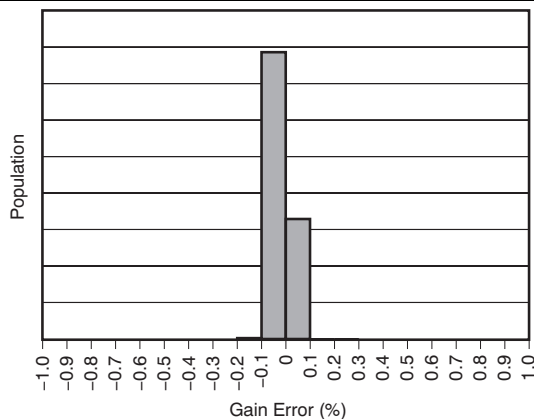

Figure 5. Gain Error Production Distribution

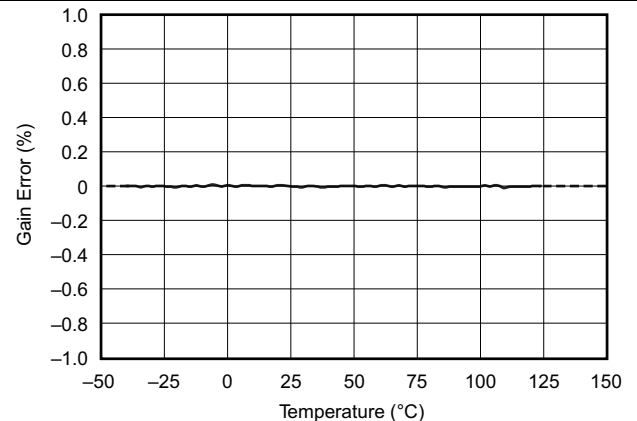

Figure 6. Gain Error vs Temperature

Typical Characteristics (continued)

The INA210 is used for typical characteristics at  $T_A = 25^\circ\text{C}$ ,  $V_S = 5\text{ V}$ ,  $V_{IN+} = 12\text{ V}$ , and  $V_{REF} = V_S / 2$ , unless otherwise noted.



Figure 7. Gain vs Frequency



$V_S = 5\text{ V} + 250\text{-mV sine disturbance}$   
 $V_{CM} = 0\text{ V}$        $V_{REF} = 2.5\text{ V}$        $V_{DIF} = \text{shorted}$

Figure 8. Power-Supply Rejection Ratio vs Frequency



$V_S = 5\text{ V}$        $V_{CM} = 1\text{ V sine}$        $V_{DIF} = \text{shorted}$   
 $V_{REF} = 2.5\text{ V}$

Figure 9. Common-Mode Rejection Ratio vs Frequency



$V_S = 2.7\text{ V}$        $V_S = 2.7\text{ V}$        $V_S = 5\text{ V to } 26\text{ V}$   
 $V_S = 2.7\text{ V to } 26\text{ V}$

Figure 10. Output Voltage Swing vs Output Current

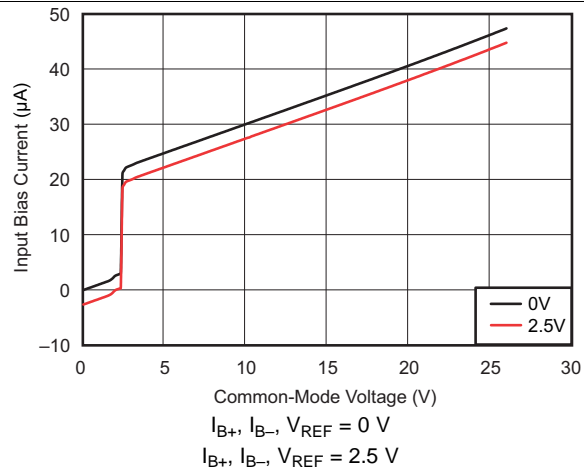

$I_{B+}, I_{B-}, V_{REF} = 0\text{ V}$   
 $I_{B+}, I_{B-}, V_{REF} = 2.5\text{ V}$

Figure 11. Input Bias Current vs Common-Mode Voltage With Supply Voltage = 5 V

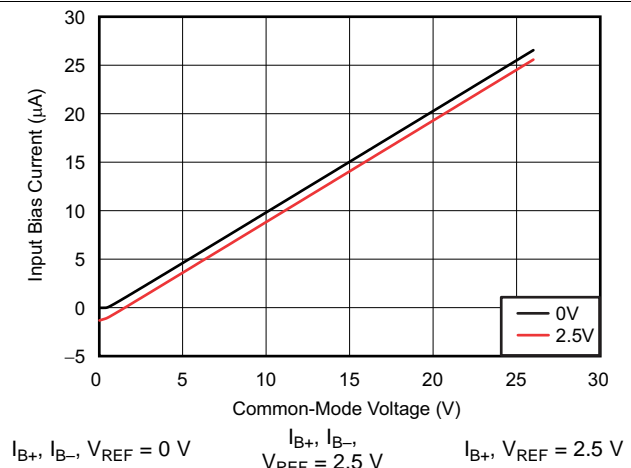

$I_{B+}, I_{B-}, V_{REF} = 0\text{ V}$        $I_{B+}, I_{B-}, V_{REF} = 2.5\text{ V}$        $I_{B+}, V_{REF} = 2.5\text{ V}$

Figure 12. Input Bias Current vs Common-Mode Voltage With Supply Voltage = 0 V (Shutdown)

### Typical Characteristics (continued)

The INA210 is used for typical characteristics at  $T_A = 25^\circ\text{C}$ ,  $V_S = 5\text{ V}$ ,  $V_{IN+} = 12\text{ V}$ , and  $V_{REF} = V_S / 2$ , unless otherwise noted.

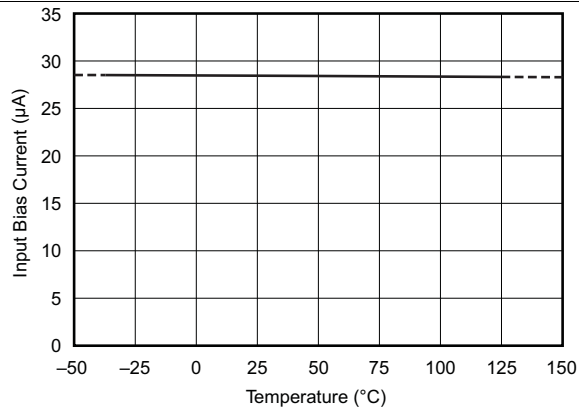

Figure 13. Input Bias Current vs Temperature



Figure 14. Quiescent Current vs Temperature



Figure 15. Input-Referred Voltage Noise vs Frequency



Figure 16. 0.1-Hz to 10-Hz Voltage Noise (Referred-To-Input)

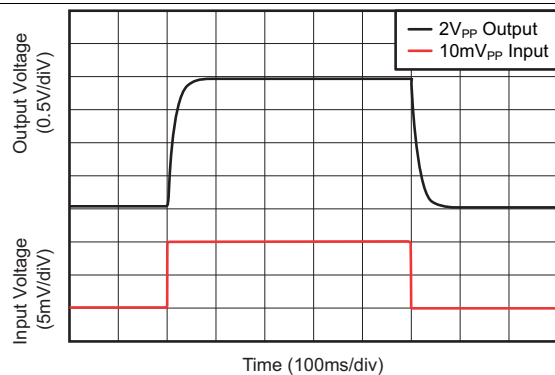

Figure 17. Step Response (10-mV<sub>PP</sub> Input Step)



Figure 18. Common-Mode Voltage Transient Response

**Typical Characteristics (continued)**

The INA210 is used for typical characteristics at  $T_A = 25^\circ\text{C}$ ,  $V_S = 5\text{ V}$ ,  $V_{IN+} = 12\text{ V}$ , and  $V_{REF} = V_S / 2$ , unless otherwise noted.

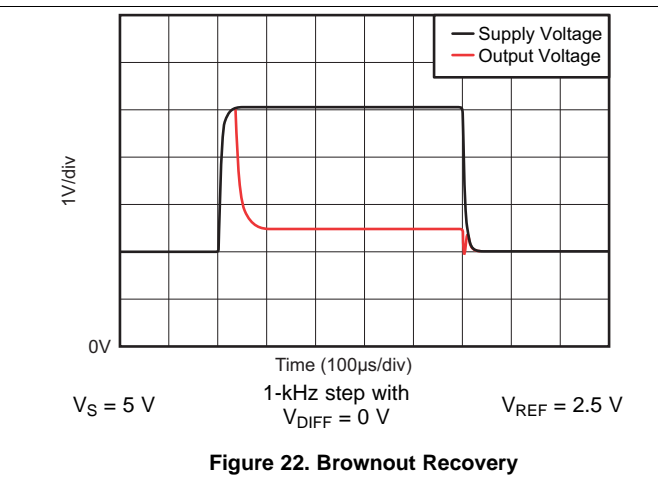
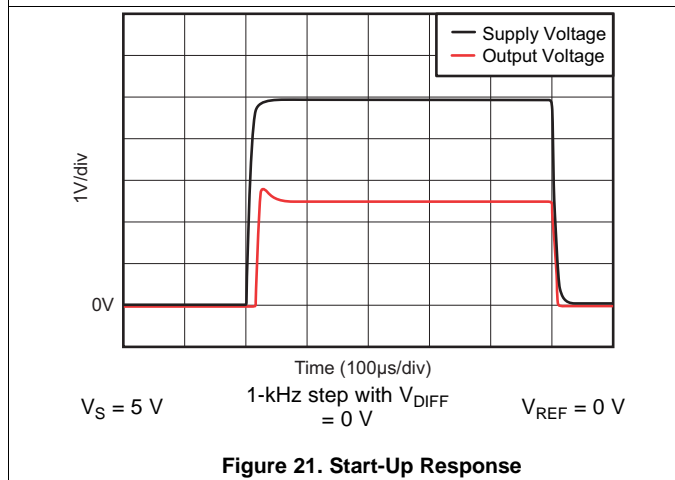
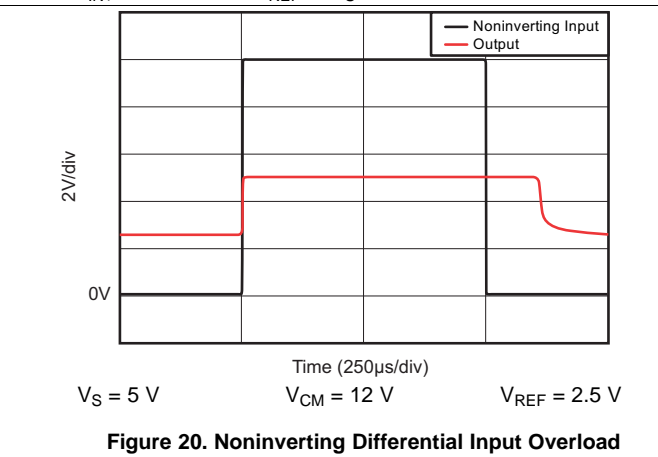
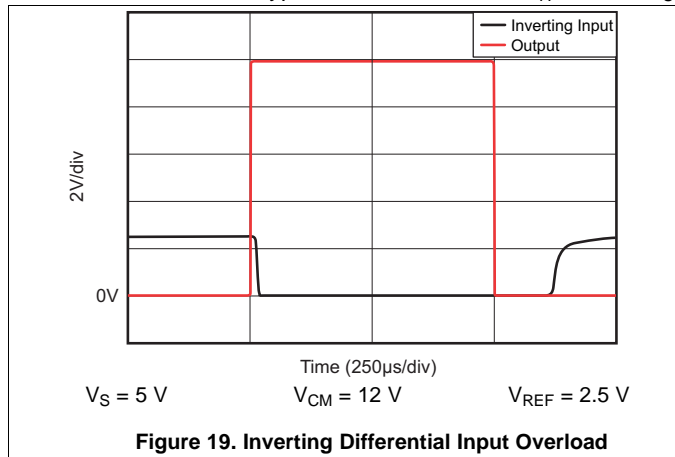

## 7 Detailed Description

### 7.1 Overview

The INA21x are 26-V, common-mode, zero-drift topology, current-sensing amplifiers that can be used in both low-side and high-side configurations. These specially-designed, current-sensing amplifiers are able to accurately measure voltages developed across current-sensing resistors on common-mode voltages that far exceed the supply voltage powering the device. Current can be measured on input voltage rails as high as 26 V while the device can be powered from supply voltages as low as 2.7 V.

The zero-drift topology enables high-precision measurements with maximum input offset voltages as low as 35  $\mu\text{V}$  with a maximum temperature contribution of 0.5  $\mu\text{V}/^\circ\text{C}$  over the full temperature range of  $-40^\circ\text{C}$  to  $+125^\circ\text{C}$ .

### 7.2 Functional Block Diagram



Copyright © 2017, Texas Instruments Incorporated

## 7.3 Feature Description

### 7.3.1 Basic Connections

Figure 23 shows the basic connections of the INA21x. Connect the input pins (IN+ and IN–) as closely as possible to the shunt resistor to minimize any resistance in series with the shunt resistor.

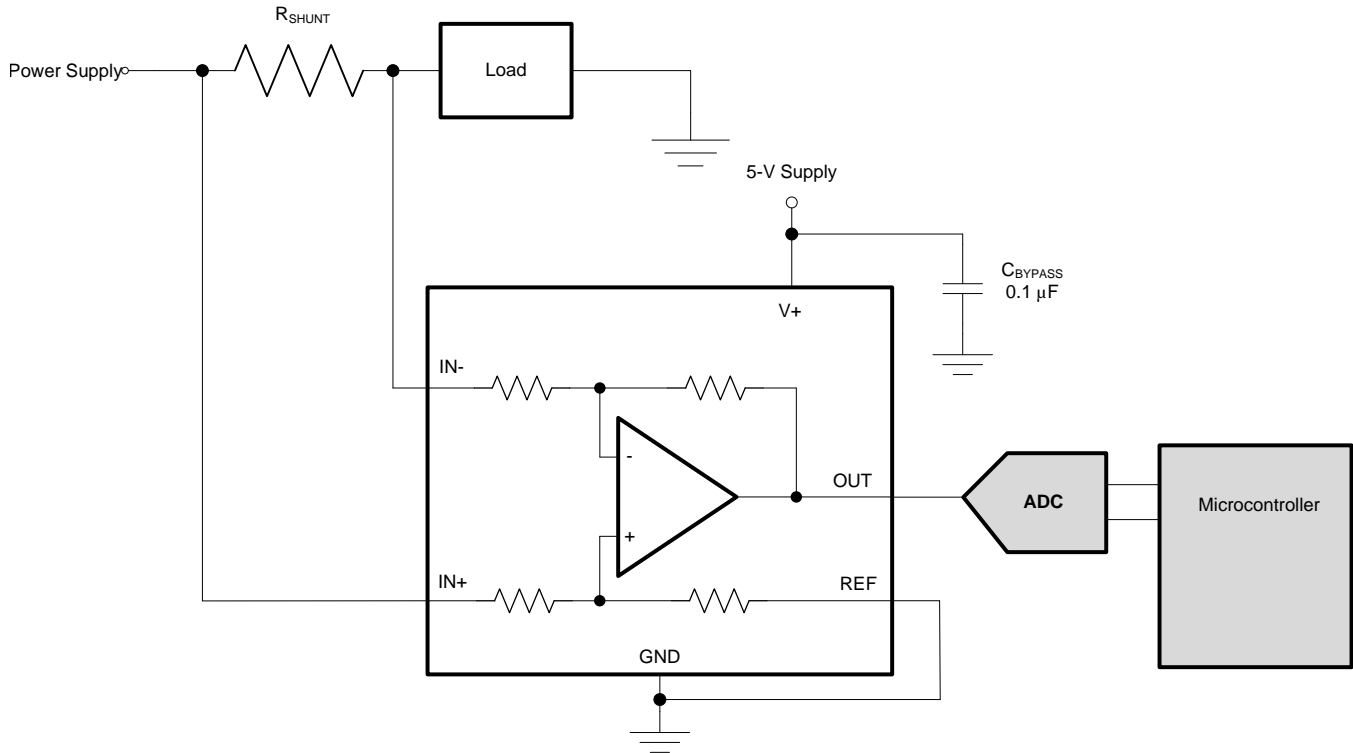

Copyright © 2017, Texas Instruments Incorporated

**Figure 23. Typical Application**

Power-supply bypass capacitors are required for stability. Applications with noisy or high-impedance power supplies may require additional decoupling capacitors to reject power-supply noise. Connect bypass capacitors close to the device pins.

On the RSW package options, two pins are provided for each input. Tie these pins together (that is, tie IN+ to IN+ and tie IN– to IN–).

### 7.3.2 Selecting $R_S$

The zero-drift offset performance of the INA21x offers several benefits. Most often, the primary advantage of the low offset characteristic enables lower full-scale drops across the shunt. For example, non-zero-drift current shunt monitors typically require a full-scale range of 100 mV.

The INA21x series gives equivalent accuracy at a full-scale range on the order of 10 mV. This accuracy reduces shunt dissipation by an order of magnitude with many additional benefits.

Alternatively, there are applications that must measure current over a wide dynamic range that can take advantage of the low offset on the low end of the measurement. Most often, these applications can use the lower gains of the INA213, INA214, or INA215 to accommodate larger shunt drops on the upper end of the scale. For instance, an INA213 operating on a 3.3-V supply can easily handle a full-scale shunt drop of 60 mV, with only 100  $\mu$ V of offset.

## 7.4 Device Functional Modes

### 7.4.1 Input Filtering

An obvious and straightforward filtering location is at the device output. However, this location negates the advantage of the low output impedance of the internal buffer. The only other filtering option is at the device input pins. This location, though, does require consideration of the  $\pm 30\%$  tolerance of the internal resistances.

Figure 24 shows a filter placed at the inputs pins.



**Figure 24. Filter at Input Pins**

The addition of external series resistance, however, creates an additional error in the measurement so the value of these series resistors must be kept to  $10\ \Omega$  (or less, if possible) to reduce impact to accuracy. The internal bias network shown in Figure 24 present at the input pins creates a mismatch in input bias currents when a differential voltage is applied between the input pins. If additional external series filter resistors are added to the circuit, the mismatch in bias currents results in a mismatch of voltage drops across the filter resistors. This mismatch creates a differential error voltage that subtracts from the voltage developed at the shunt resistor. This error results in a voltage at the device input pins that is different than the voltage developed across the shunt resistor. Without the additional series resistance, the mismatch in input bias currents has little effect on device operation. The amount of error these external filter resistors add to the measurement can be calculated using Equation 2 where the gain error factor is calculated using Equation 1.

The amount of variance in the differential voltage present at the device input relative to the voltage developed at the shunt resistor is based both on the external series resistance value as well as the internal input resistors,  $R_3$  and  $R_4$  (or  $R_{INT}$  as shown in Figure 24). The reduction of the shunt voltage reaching the device input pins appears as a gain error when comparing the output voltage relative to the voltage across the shunt resistor. A factor can be calculated to determine the amount of gain error that is introduced by the addition of external series resistance. The equation used to calculate the expected deviation from the shunt voltage to what is measured at the device input pins is given in Equation 1:

$$\text{Gain Error Factor} = \frac{(1250 \times R_{INT})}{(1250 \times R_S) + (1250 \times R_{INT}) + (R_S \times R_{INT})}$$

where:

- $R_{INT}$  is the internal input resistor ( $R_3$  and  $R_4$ ), and
- $R_S$  is the external series resistance.

(1)

## Device Functional Modes (continued)

With the adjustment factor from [Equation 1](#), including the device internal input resistance, this factor varies with each gain version, as shown in [Table 1](#). Each individual device gain error factor is shown in [Table 2](#).

**Table 1. Input Resistance**

PRODUCT	GAIN	R <sub>INT</sub> (kΩ)
INA210	200	5
INA211	500	2
INA212	1000	1
INA213	50	20
INA214	100	10
INA215	75	13.3

**Table 2. Device Gain Error Factor**

PRODUCT	SIMPLIFIED GAIN ERROR FACTOR
INA210	$\frac{1000}{R_S + 1000}$
INA211	$\frac{10,000}{(13 \times R_S) + 10,000}$
INA212	$\frac{5000}{(9 \times R_S) + 5000}$
INA213	$\frac{20,000}{(17 \times R_S) + 20,000}$
INA214	$\frac{10,000}{(9 \times R_S) + 10,000}$
INA215	$\frac{8,000}{(7 \times R_S) + 8,000}$

The gain error that can be expected from the addition of the external series resistors can then be calculated based on [Equation 2](#):

$$\text{Gain Error (\%)} = 100 - (100 \times \text{Gain Error Factor}) \quad (2)$$

For example, using an INA212 and the corresponding gain error equation from [Table 2](#), a series resistance of 10 Ω results in a gain error factor of 0.982. The corresponding gain error is then calculated using [Equation 2](#), resulting in a gain error of approximately 1.77% solely because of the external 10-Ω series resistors. Using an INA213 with the same 10-Ω series resistor results in a gain error factor of 0.991 and a gain error of 0.84% again solely because of these external resistors.

### 7.4.2 Shutting Down the INA21x Series

Although the INA21x series does not have a shutdown pin, the low power consumption of the device allows the output of a logic gate or transistor switch to power the INA21x. This gate or switch turns on and turns off the INA21x power-supply quiescent current.

However, in current shunt monitoring applications, there is also a concern for how much current is drained from the shunt circuit in shutdown conditions. Evaluating this current drain involves considering the simplified schematic of the INA21x in shutdown mode, as shown in Figure 25.



Copyright © 2017, Texas Instruments Incorporated

NOTE: 1-MΩ paths from shunt inputs to reference and INA21x outputs.

**Figure 25. Basic Circuit for Shutting Down The INA21x With a Grounded Reference**

Note that there is typically slightly more than 1-MΩ impedance (from the combination of 1-MΩ feedback and 5-kΩ input resistors) from each input of the INA21x to the OUT pin and to the REF pin. The amount of current flowing through these pins depends on the respective ultimate connection. For example, if the REF pin is grounded, the calculation of the effect of the 1-MΩ impedance from the shunt to ground is straightforward. However, if the reference or op amp is powered while the INA21x is shut down, the calculation is direct; instead of assuming 1 MΩ to ground, however, assume 1 MΩ to the reference voltage. If the reference or op amp is also shut down, some knowledge of the reference or op amp output impedance under shutdown conditions is required. For instance, if the reference source behaves as an open circuit when not powered, little or no current flows through the 1-MΩ path.

Regarding the 1-MΩ path to the output pin, the output stage of a disabled INA21x does constitute a good path to ground. Consequently, this current is directly proportional to a shunt common-mode voltage present across a 1-MΩ resistor.

As a final note, when the device is powered up, there is an additional, nearly constant, and well-matched 25 μA that flows in each of the inputs as long as the shunt common-mode voltage is 3 V or higher. Below 2-V common-mode, the only current effects are the result of the 1-MΩ resistors.

### 7.4.3 REF Input Impedance Effects

As with any difference amplifier, the INA21x series common-mode rejection ratio is affected by any impedance present at the REF input. This concern is not a problem when the REF pin is connected directly to most references or power supplies. When using resistive dividers from the power supply or a reference voltage, the REF pin must be buffered by an op amp.

In systems where the INA21x output can be sensed differentially, such as by a differential input analog-to-digital converter (ADC) or by using two separate ADC inputs, the effects of external impedance on the REF input can be cancelled. [Figure 26](#) depicts a method of taking the output from the INA21x by using the REF pin as a reference.



Copyright © 2017, Texas Instruments Incorporated

**Figure 26. Sensing the INA21x to Cancel the Effects of Impedance on the REF Input**

### 7.4.4 Using The INA21x With Common-Mode Transients Above 26 V

With a small amount of additional circuitry, the INA21x series can be used in circuits subject to transients higher than 26 V, such as automotive applications. Use only zener diode or zener-type transient absorbers (sometimes referred to as *transzorb*s); any other type of transient absorber has an unacceptable time delay. Start by adding a pair of resistors as a working impedance for the zener; see [Figure 27](#). Keeping these resistors as small as possible is preferable, typically around 10 Ω. Larger values can be used with an effect on gain that is discussed in the [Input Filtering](#) section. Because this circuit limits only short-term transients, many applications are satisfied with a 10-Ω resistor along with conventional zener diodes of the lowest power rating that can be found. This combination uses the least amount of board space. These diodes can be found in packages as small as SOT-523 or SOD-523.



**Figure 27. INA21x Transient Protection Using Dual Zener Diodes**

In the event that low-power zeners do not have sufficient transient absorption capability and a higher power transzorb must be used, the most package-efficient solution then involves using a single transzorb and back-to-back diodes between the device inputs. The most space-efficient solutions are dual series-connected diodes in a single SOT-523 or SOD-523 package. This method is shown in Figure 28. In either of these examples, the total board area required by the INA21x with all protective components is less than that of an SO-8 package, and only slightly greater than that of an MSOP-8 package.



**Figure 28. INA21x Transient Protection Using a Single Transzorb and Input Clamps**

### 7.4.5 Improving Transient Robustness

Applications involving large input transients with excessive  $dV/dt$  above 2 kV per microsecond present at the device input pins may cause damage to the internal ESD structures on version A devices. This potential damage is a result of the internal latching of the ESD structure to ground when this transient occurs at the input. With significant current available in most current-sensing applications, the large current flowing through the input transient-triggered, ground-shorted ESD structure quickly results in damage to the silicon. External filtering can be used to attenuate the transient signal prior to reaching the inputs to avoid the latching condition. Care must be taken to ensure that external series input resistance does not significantly impact gain error accuracy. For accuracy purposes, keep these resistances under  $10\ \Omega$  if possible. Ferrite beads are recommended for this filter because of their inherently low dc ohmic value. Ferrite beads with less than  $10\ \Omega$  of resistance at dc and over  $600\ \Omega$  of resistance at 100 MHz to 200 MHz are recommended. The recommended capacitor values for this filter are between  $0.01\ \mu\text{F}$  and  $0.1\ \mu\text{F}$  to ensure adequate attenuation in the high-frequency region. This protection scheme is shown in Figure 29.



**Figure 29. Transient Protection**

To minimize the cost of adding these external components to protect the device in applications where large transient signals may be present, version B and C devices are now available with new ESD structures that are not susceptible to this latching condition. Version B and C devices are incapable of sustaining these damage-causing latched conditions so these devices do not have the same sensitivity to the transients that the version A devices have, thus making the version B and C devices a better fit for these applications.

## 8 Application and Implementation

### NOTE

Information in the following applications sections is not part of the TI component specification, and TI does not warrant its accuracy or completeness. TI's customers are responsible for determining suitability of components for their purposes. Customers should validate and test their design implementation to confirm system functionality.

### 8.1 Application Information

The INA21x devices measure the voltage developed across a current-sensing resistor when current passes through the device. The ability to drive the reference pin to adjust the functionality of the output signal offers multiple configurations, as discussed throughout this section.

### 8.2 Typical Applications

#### 8.2.1 Unidirectional Operation



Copyright © 2017, Texas Instruments Incorporated

**Figure 30. Unidirectional Application Schematic**

##### 8.2.1.1 Design Requirements

The device can be configured to monitor current flowing in one direction (unidirectional) or in both directions (bidirectional) depending on how the REF pin is configured. The most common case is unidirectional where the output is set to ground when no current is flowing by connecting the REF pin to ground, as shown in [Figure 30](#). When the input signal increases, the output voltage at the OUT pin increases.

##### 8.2.1.2 Detailed Design Procedure

The linear range of the output stage is limited in how close the output voltage can approach ground under zero input conditions. In unidirectional applications where measuring very low input currents is desirable, bias the REF pin to a convenient value above 50 mV to get the output into the linear range of the device. To limit common-mode rejection errors, TI recommends buffering the reference voltage connected to the REF pin.

A less frequently-used output biasing method is to connect the REF pin to the supply voltage, V+. This method results in the output voltage saturating at 200 mV below the supply voltage when no differential input signal is present. This method is similar to the output saturated low condition with no input signal when the REF pin is connected to ground. The output voltage in this configuration only responds to negative currents that develop negative differential input voltage relative to the device IN– pin. Under these conditions, when the differential input signal increases negatively, the output voltage moves downward from the saturated supply voltage. The voltage applied to the REF pin must not exceed the device supply voltage.

**Typical Applications (continued)**

**8.2.1.3 Application Curve**

An example output response of a unidirectional configuration is shown in [Figure 31](#). With the REF pin connected directly to ground, the output voltage is biased to this zero output level. The output rises above the reference voltage for positive differential input signals but cannot fall below the reference voltage for negative differential input signals because of the grounded reference voltage.



**Figure 31. Unidirectional Application Output Response**

## Typical Applications (continued)

### 8.2.2 Bidirectional Operation

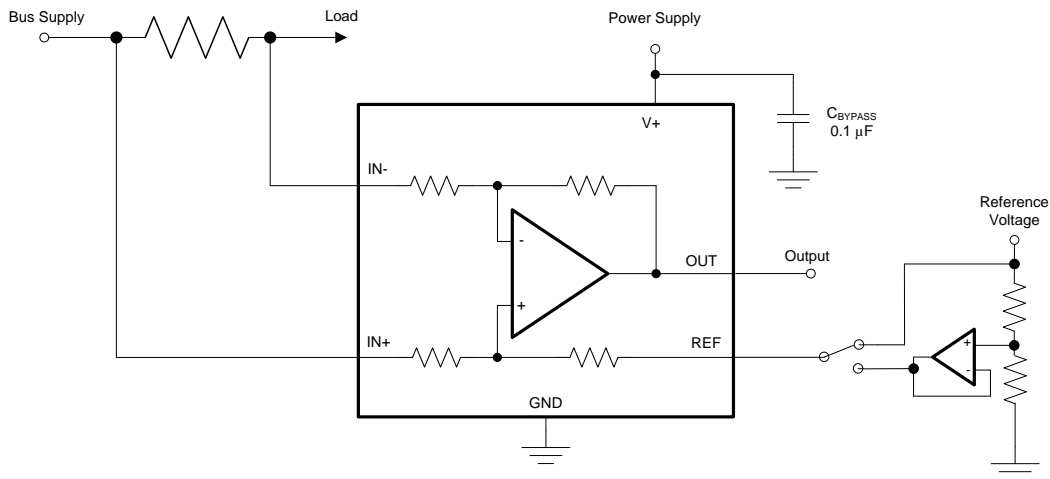

Copyright © 2017, Texas Instruments Incorporated

**Figure 32. Bidirectional Application Schematic**

#### 8.2.2.1 Design Requirements

The device is a bidirectional, current-sense amplifier capable of measuring currents through a resistive shunt in two directions. This bidirectional monitoring is common in applications that include charging and discharging operations where the current flow-through resistor can change directions.

#### 8.2.2.2 Detailed Design Procedure

The ability to measure this current flowing in both directions is enabled by applying a voltage to the REF pin, as shown in Figure 32. The voltage applied to REF ( $V_{REF}$ ) sets the output state that corresponds to the zero-input level state. The output then responds by increasing above  $V_{REF}$  for positive differential signals (relative to the IN– pin) and responds by decreasing below  $V_{REF}$  for negative differential signals. This reference voltage applied to the REF pin can be set anywhere between 0 V to  $V_+$ . For bidirectional applications,  $V_{REF}$  is typically set at midscale for equal signal range in both current directions. In some cases, however,  $V_{REF}$  is set at a voltage other than midscale when the bidirectional current and corresponding output signal do not need to be symmetrical.

#### 8.2.2.3 Application Curve

An example output response of a bidirectional configuration is shown in Figure 33. With the REF pin connected to a reference voltage ( 2.5 V in this case) the output voltage is biased upwards by this reference level. The output rises above the reference voltage for positive differential input signals and falls below the reference voltage for negative differential input signals.

**Typical Applications (continued)**



**Figure 33. Bidirectional Application Output Response**

**9 Power Supply Recommendations**

The input circuitry of the INA21x can accurately measure beyond the power-supply voltage, V+. For example, the V+ power supply can be 5 V, whereas the load power-supply voltage can be as high as 26 V. However, the output voltage range of the OUT pin is limited by the voltages on the power-supply pin. Note also that the INA21x can withstand the full input signal range up to 26 V at the input pins, regardless of whether the device has power applied or not.

**10 Layout**

**10.1 Layout Guidelines**

- Connect the input pins to the sensing resistor using a Kelvin or 4-wire connection. This connection technique ensures that only the current-sensing resistor impedance is detected between the input pins. Poor routing of the current-sensing resistor commonly results in additional resistance present between the input pins. Given the very low ohmic value of the current resistor, any additional high-current carrying impedance can cause significant measurement errors.
- Place the power-supply bypass capacitor as closely as possible to the supply and ground pins. The recommended value of this bypass capacitor is 0.1 μF. Additional decoupling capacitance can be added to compensate for noisy or high-impedance power supplies.

## 10.2 Layout Example

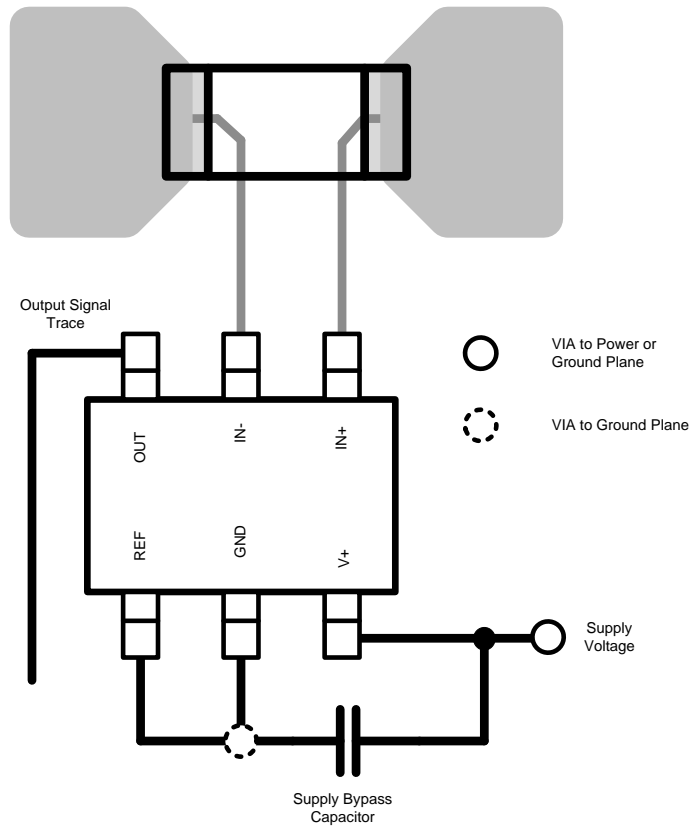

Copyright © 2017, Texas Instruments Incorporated

**Figure 34. Recommended Layout**

## 11 Device and Documentation Support

### 11.1 Documentation Support

#### 11.1.1 Related Documentation

For related documentation see the following:

- [INA210-215EVM User's Guide](#)

#### 11.2 Related Links

[Table 3](#) lists quick access links. Categories include technical documents, support and community resources, tools and software, and quick access to sample or buy.

**Table 3. Related Links**

PARTS	PRODUCT FOLDER	ORDER NOW	TECHNICAL DOCUMENTS	TOOLS & SOFTWARE	SUPPORT & COMMUNITY
INA210	<a href="#">Click here</a>	<a href="#">Click here</a>	<a href="#">Click here</a>	<a href="#">Click here</a>	<a href="#">Click here</a>
INA211	<a href="#">Click here</a>	<a href="#">Click here</a>	<a href="#">Click here</a>	<a href="#">Click here</a>	<a href="#">Click here</a>
INA212	<a href="#">Click here</a>	<a href="#">Click here</a>	<a href="#">Click here</a>	<a href="#">Click here</a>	<a href="#">Click here</a>
INA213	<a href="#">Click here</a>	<a href="#">Click here</a>	<a href="#">Click here</a>	<a href="#">Click here</a>	<a href="#">Click here</a>
INA214	<a href="#">Click here</a>	<a href="#">Click here</a>	<a href="#">Click here</a>	<a href="#">Click here</a>	<a href="#">Click here</a>
INA215	<a href="#">Click here</a>	<a href="#">Click here</a>	<a href="#">Click here</a>	<a href="#">Click here</a>	<a href="#">Click here</a>

#### 11.3 Receiving Notification of Documentation Updates

To receive notification of documentation updates, navigate to the device product folder on [ti.com](http://ti.com). In the upper right corner, click on *Alert me* to register and receive a weekly digest of any product information that has changed. For change details, review the revision history included in any revised document.

#### 11.4 Community Resources

The following links connect to TI community resources. Linked contents are provided "AS IS" by the respective contributors. They do not constitute TI specifications and do not necessarily reflect TI's views; see TI's [Terms of Use](#).

**TI E2E™ Online Community** *TI's Engineer-to-Engineer (E2E) Community*. Created to foster collaboration among engineers. At [e2e.ti.com](http://e2e.ti.com), you can ask questions, share knowledge, explore ideas and help solve problems with fellow engineers.

**Design Support** *TI's Design Support* Quickly find helpful E2E forums along with design support tools and contact information for technical support.

#### 11.5 Trademarks

E2E is a trademark of Texas Instruments.

All other trademarks are the property of their respective owners.

#### 11.6 Electrostatic Discharge Caution



This integrated circuit can be damaged by ESD. Texas Instruments recommends that all integrated circuits be handled with appropriate precautions. Failure to observe proper handling and installation procedures can cause damage.

ESD damage can range from subtle performance degradation to complete device failure. Precision integrated circuits may be more susceptible to damage because very small parametric changes could cause the device not to meet its published specifications.

#### 11.7 Glossary

[SLYZ022](#) — *TI Glossary*.

This glossary lists and explains terms, acronyms, and definitions.

## 12 Mechanical, Packaging, and Orderable Information

The following pages include mechanical, packaging, and orderable information. This information is the most current data available for the designated devices. This data is subject to change without notice and revision of this document. For browser-based versions of this data sheet, refer to the left-hand navigation.

**PACKAGING INFORMATION**

Orderable Device	Status (1)	Package Type	Package Drawing	Pins	Package Qty	Eco Plan (2)	Lead/Ball Finish (6)	MSL Peak Temp (3)	Op Temp (°C)	Device Marking (4/5)	Samples
INA210AIDCKR	ACTIVE	SC70	DCK	6	3000	Green (RoHS & no Sb/Br)	CU NIPDAU	Level-2-260C-1 YEAR	-40 to 125	CET	<a href="#">Samples</a>
INA210AIDCKT	ACTIVE	SC70	DCK	6	250	Green (RoHS & no Sb/Br)	CU NIPDAU	Level-2-260C-1 YEAR	-40 to 125	CET	<a href="#">Samples</a>
INA210AIRSWR	ACTIVE	UQFN	RSW	10	3000	Green (RoHS & no Sb/Br)	CU NIPDAU   Call TI	Level-1-260C-UNLIM	-40 to 125	KNJ	<a href="#">Samples</a>
INA210AIRSWT	ACTIVE	UQFN	RSW	10	250	Green (RoHS & no Sb/Br)	CU NIPDAU   Call TI	Level-1-260C-UNLIM	-40 to 125	(KNJ, NSJ)	<a href="#">Samples</a>
INA210BIDCKR	ACTIVE	SC70	DCK	6	3000	Green (RoHS & no Sb/Br)	CU NIPDAU	Level-2-260C-1 YEAR	-40 to 125	SED	<a href="#">Samples</a>
INA210BIDCKT	ACTIVE	SC70	DCK	6	250	Green (RoHS & no Sb/Br)	CU NIPDAU	Level-2-260C-1 YEAR	-40 to 125	SED	<a href="#">Samples</a>
INA210BIRSWR	ACTIVE	UQFN	RSW	10	3000	Green (RoHS & no Sb/Br)	CU NIPDAU	Level-1-260C-UNLIM	-40 to 125	SHQ	<a href="#">Samples</a>
INA210BIRSWT	ACTIVE	UQFN	RSW	10	250	Green (RoHS & no Sb/Br)	CU NIPDAU	Level-1-260C-UNLIM	-40 to 125	SHQ	<a href="#">Samples</a>
INA210CIDCKR	ACTIVE	SC70	DCK	6	3000	Green (RoHS & no Sb/Br)	CU NIPDAU	Level-2-260C-1 YEAR	-40 to 125	16B	<a href="#">Samples</a>
INA210CIDCKT	ACTIVE	SC70	DCK	6	250	Green (RoHS & no Sb/Br)	CU NIPDAU	Level-2-260C-1 YEAR	-40 to 125	16B	<a href="#">Samples</a>
INA210CIRSWR	ACTIVE	UQFN	RSW	10	3000	Green (RoHS & no Sb/Br)	CU NIPDAU	Level-1-260C-UNLIM	-40 to 125	16C	<a href="#">Samples</a>
INA210CIRSWT	ACTIVE	UQFN	RSW	10	250	Green (RoHS & no Sb/Br)	CU NIPDAU	Level-1-260C-UNLIM	-40 to 125	16C	<a href="#">Samples</a>
INA211AIDCKR	ACTIVE	SC70	DCK	6	3000	Green (RoHS & no Sb/Br)	CU NIPDAU	Level-2-260C-1 YEAR	-40 to 125	CEU	<a href="#">Samples</a>
INA211AIDCKT	ACTIVE	SC70	DCK	6	250	Green (RoHS & no Sb/Br)	CU NIPDAU	Level-2-260C-1 YEAR	-40 to 125	CEU	<a href="#">Samples</a>
INA211BIDCKR	ACTIVE	SC70	DCK	6	3000	Green (RoHS & no Sb/Br)	CU NIPDAU	Level-2-260C-1 YEAR	-40 to 125	SEE	<a href="#">Samples</a>
INA211BIDCKT	ACTIVE	SC70	DCK	6	250	Green (RoHS & no Sb/Br)	CU NIPDAU	Level-2-260C-1 YEAR	-40 to 125	SEE	<a href="#">Samples</a>
INA211BIRSWR	ACTIVE	UQFN	RSW	10	3000	Green (RoHS & no Sb/Br)	CU NIPDAU	Level-1-260C-UNLIM	-40 to 125	13Q	<a href="#">Samples</a>

Orderable Device	Status (1)	Package Type	Package Drawing	Pins	Package Qty	Eco Plan (2)	Lead/Ball Finish (6)	MSL Peak Temp (3)	Op Temp (°C)	Device Marking (4/5)	Samples
INA211BIRSWT	ACTIVE	UQFN	RSW	10	250	Green (RoHS & no Sb/Br)	CU NIPDAU	Level-1-260C-UNLIM	-40 to 125	13Q	<a href="#">Samples</a>
INA211CIDCKR	ACTIVE	SC70	DCK	6	3000	Green (RoHS & no Sb/Br)	CU NIPDAU	Level-2-260C-1 YEAR	-40 to 125	16D	<a href="#">Samples</a>
INA211CIDCKT	ACTIVE	SC70	DCK	6	250	Green (RoHS & no Sb/Br)	CU NIPDAU	Level-2-260C-1 YEAR	-40 to 125	16D	<a href="#">Samples</a>
INA211CIRSWR	ACTIVE	UQFN	RSW	10	3000	Green (RoHS & no Sb/Br)	CU NIPDAU	Level-1-260C-UNLIM	-40 to 125	16U	<a href="#">Samples</a>
INA211CIRSWT	ACTIVE	UQFN	RSW	10	250	Green (RoHS & no Sb/Br)	CU NIPDAU	Level-1-260C-UNLIM	-40 to 125	16U	<a href="#">Samples</a>
INA212AIDCKR	ACTIVE	SC70	DCK	6	3000	Green (RoHS & no Sb/Br)	CU NIPDAU	Level-2-260C-1 YEAR	-40 to 125	CEV	<a href="#">Samples</a>
INA212AIDCKT	ACTIVE	SC70	DCK	6	250	Green (RoHS & no Sb/Br)	CU NIPDAU	Level-2-260C-1 YEAR	-40 to 125	CEV	<a href="#">Samples</a>
INA212BIDCKR	ACTIVE	SC70	DCK	6	3000	Green (RoHS & no Sb/Br)	CU NIPDAU	Level-2-260C-1 YEAR	-40 to 125	SEC	<a href="#">Samples</a>
INA212BIDCKT	ACTIVE	SC70	DCK	6	250	Green (RoHS & no Sb/Br)	CU NIPDAU	Level-2-260C-1 YEAR	-40 to 125	SEC	<a href="#">Samples</a>
INA212BIRSWR	ACTIVE	UQFN	RSW	10	3000	Green (RoHS & no Sb/Br)	CU NIPDAU	Level-1-260C-UNLIM	-40 to 125	13U	<a href="#">Samples</a>
INA212BIRSWT	ACTIVE	UQFN	RSW	10	250	Green (RoHS & no Sb/Br)	CU NIPDAU	Level-1-260C-UNLIM	-40 to 125	13U	<a href="#">Samples</a>
INA212CIDCKR	ACTIVE	SC70	DCK	6	3000	Green (RoHS & no Sb/Br)	CU NIPDAU	Level-2-260C-1 YEAR	-40 to 125	16E	<a href="#">Samples</a>
INA212CIDCKT	ACTIVE	SC70	DCK	6	250	Green (RoHS & no Sb/Br)	CU NIPDAU	Level-2-260C-1 YEAR	-40 to 125	16E	<a href="#">Samples</a>
INA212CIRSWR	ACTIVE	UQFN	RSW	10	3000	Green (RoHS & no Sb/Br)	CU NIPDAU	Level-1-260C-UNLIM	-40 to 125	16V	<a href="#">Samples</a>
INA212CIRSWT	ACTIVE	UQFN	RSW	10	250	Green (RoHS & no Sb/Br)	CU NIPDAU	Level-1-260C-UNLIM	-40 to 125	16V	<a href="#">Samples</a>
INA213AIDCKR	ACTIVE	SC70	DCK	6	3000	Green (RoHS & no Sb/Br)	CU NIPDAU	Level-2-260C-1 YEAR	-40 to 125	CFT	<a href="#">Samples</a>
INA213AIDCKT	ACTIVE	SC70	DCK	6	250	Green (RoHS & no Sb/Br)	CU NIPDAU	Level-2-260C-1 YEAR	-40 to 125	CFT	<a href="#">Samples</a>
INA213AIRSWR	ACTIVE	UQFN	RSW	10	3000	Green (RoHS & no Sb/Br)	CU NIPDAU	Level-1-260C-UNLIM	-40 to 125	KPJ	<a href="#">Samples</a>

Orderable Device	Status (1)	Package Type	Package Drawing	Pins	Package Qty	Eco Plan (2)	Lead/Ball Finish (6)	MSL Peak Temp (3)	Op Temp (°C)	Device Marking (4/5)	Samples
INA213AIRSWT	ACTIVE	UQFN	RSW	10	250	Green (RoHS & no Sb/Br)	CU NIPDAU	Level-1-260C-UNLIM	-40 to 125	KPJ	<a href="#">Samples</a>
INA213BIDCKR	ACTIVE	SC70	DCK	6	3000	Green (RoHS & no Sb/Br)	CU NIPDAU	Level-2-260C-1 YEAR	-40 to 125	SEF	<a href="#">Samples</a>
INA213BIDCKT	ACTIVE	SC70	DCK	6	250	Green (RoHS & no Sb/Br)	CU NIPDAU	Level-2-260C-1 YEAR	-40 to 125	SEF	<a href="#">Samples</a>
INA213BIRSWR	ACTIVE	UQFN	RSW	10	3000	Green (RoHS & no Sb/Br)	CU NIPDAU	Level-1-260C-UNLIM	-40 to 125	SHT	<a href="#">Samples</a>
INA213BIRSWT	ACTIVE	UQFN	RSW	10	250	Green (RoHS & no Sb/Br)	CU NIPDAU	Level-1-260C-UNLIM	-40 to 125	SHT	<a href="#">Samples</a>
INA213CIDCKR	ACTIVE	SC70	DCK	6	3000	Green (RoHS & no Sb/Br)	CU NIPDAU	Level-2-260C-1 YEAR	-40 to 125	16F	<a href="#">Samples</a>
INA213CIDCKT	ACTIVE	SC70	DCK	6	250	Green (RoHS & no Sb/Br)	CU NIPDAU	Level-2-260C-1 YEAR	-40 to 125	16F	<a href="#">Samples</a>
INA213CIRSWR	ACTIVE	UQFN	RSW	10	3000	Green (RoHS & no Sb/Br)	CU NIPDAU	Level-1-260C-UNLIM	-40 to 125	16W	<a href="#">Samples</a>
INA213CIRSWT	ACTIVE	UQFN	RSW	10	250	Green (RoHS & no Sb/Br)	CU NIPDAU	Level-1-260C-UNLIM	-40 to 125	16W	<a href="#">Samples</a>
INA214AIDCKR	ACTIVE	SC70	DCK	6	3000	Green (RoHS & no Sb/Br)	CU NIPDAU	Level-2-260C-1 YEAR	-40 to 125	CFV	<a href="#">Samples</a>
INA214AIDCKT	ACTIVE	SC70	DCK	6	250	Green (RoHS & no Sb/Br)	CU NIPDAU	Level-2-260C-1 YEAR	-40 to 125	CFV	<a href="#">Samples</a>
INA214AIRSWR	ACTIVE	UQFN	RSW	10	3000	Green (RoHS & no Sb/Br)	CU NIPDAU   Call TI	Level-1-260C-UNLIM	-40 to 125	KRJ	<a href="#">Samples</a>
INA214AIRSWT	ACTIVE	UQFN	RSW	10	250	Green (RoHS & no Sb/Br)	CU NIPDAU   Call TI	Level-1-260C-UNLIM	-40 to 125	KRJ	<a href="#">Samples</a>
INA214BIDCKR	ACTIVE	SC70	DCK	6	3000	Green (RoHS & no Sb/Br)	CU NIPDAU	Level-2-260C-1 YEAR	-40 to 125	SEA	<a href="#">Samples</a>
INA214BIDCKT	ACTIVE	SC70	DCK	6	250	Green (RoHS & no Sb/Br)	CU NIPDAU	Level-2-260C-1 YEAR	-40 to 125	SEA	<a href="#">Samples</a>
INA214BIRSWR	ACTIVE	UQFN	RSW	10	3000	Green (RoHS & no Sb/Br)	CU NIPDAU	Level-1-260C-UNLIM	-40 to 125	SHU	<a href="#">Samples</a>
INA214BIRSWT	ACTIVE	UQFN	RSW	10	250	Green (RoHS & no Sb/Br)	CU NIPDAU	Level-1-260C-UNLIM	-40 to 125	SHU	<a href="#">Samples</a>
INA214CIDCKR	ACTIVE	SC70	DCK	6	3000	Green (RoHS & no Sb/Br)	CU NIPDAU	Level-2-260C-1 YEAR	-40 to 125	16G	<a href="#">Samples</a>

Orderable Device	Status (1)	Package Type	Package Drawing	Pins	Package Qty	Eco Plan (2)	Lead/Ball Finish (6)	MSL Peak Temp (3)	Op Temp (°C)	Device Marking (4/5)	Samples
INA214CIDCKT	ACTIVE	SC70	DCK	6	250	Green (RoHS & no Sb/Br)	CU NIPDAU	Level-2-260C-1 YEAR	-40 to 125	16G	<a href="#">Samples</a>
INA214CIRSWR	ACTIVE	UQFN	RSW	10	3000	Green (RoHS & no Sb/Br)	CU NIPDAU	Level-1-260C-UNLIM	-40 to 125	16X	<a href="#">Samples</a>
INA214CIRSWT	ACTIVE	UQFN	RSW	10	250	Green (RoHS & no Sb/Br)	CU NIPDAU	Level-1-260C-UNLIM	-40 to 125	16X	<a href="#">Samples</a>
INA215AIDCKR	ACTIVE	SC70	DCK	6	3000	Green (RoHS & no Sb/Br)	CU NIPDAU	Level-2-260C-1 YEAR	-40 to 125	SME	<a href="#">Samples</a>
INA215AIDCKT	ACTIVE	SC70	DCK	6	250	Green (RoHS & no Sb/Br)	CU NIPDAU	Level-2-260C-1 YEAR	-40 to 125	SME	<a href="#">Samples</a>
INA215BIDCKR	ACTIVE	SC70	DCK	6	3000	Green (RoHS & no Sb/Br)	CU NIPDAU	Level-2-260C-1 YEAR	-40 to 125	13S	<a href="#">Samples</a>
INA215BIDCKT	ACTIVE	SC70	DCK	6	250	Green (RoHS & no Sb/Br)	CU NIPDAU	Level-2-260C-1 YEAR	-40 to 125	13S	<a href="#">Samples</a>
INA215BIRSWR	ACTIVE	UQFN	RSW	10	3000	Green (RoHS & no Sb/Br)	CU NIPDAU	Level-1-260C-UNLIM	-40 to 125	13R	<a href="#">Samples</a>
INA215BIRSWT	ACTIVE	UQFN	RSW	10	250	Green (RoHS & no Sb/Br)	CU NIPDAU	Level-1-260C-UNLIM	-40 to 125	13R	<a href="#">Samples</a>
INA215CIDCKR	ACTIVE	SC70	DCK	6	3000	Green (RoHS & no Sb/Br)	CU NIPDAU	Level-2-260C-1 YEAR	-40 to 125	17K	<a href="#">Samples</a>
INA215CIDCKT	ACTIVE	SC70	DCK	6	250	Green (RoHS & no Sb/Br)	CU NIPDAU	Level-2-260C-1 YEAR	-40 to 125	17K	<a href="#">Samples</a>
INA215CIRSWR	ACTIVE	UQFN	RSW	10	3000	Green (RoHS & no Sb/Br)	CU NIPDAU	Level-1-260C-UNLIM	-40 to 125	16Z	<a href="#">Samples</a>
INA215CIRSWT	ACTIVE	UQFN	RSW	10	250	Green (RoHS & no Sb/Br)	CU NIPDAU	Level-1-260C-UNLIM	-40 to 125	16Z	<a href="#">Samples</a>

(1) The marketing status values are defined as follows:

**ACTIVE:** Product device recommended for new designs.

**LIFEBUY:** TI has announced that the device will be discontinued, and a lifetime-buy period is in effect.

**NRND:** Not recommended for new designs. Device is in production to support existing customers, but TI does not recommend using this part in a new design.

**PREVIEW:** Device has been announced but is not in production. Samples may or may not be available.

**OBSELETE:** TI has discontinued the production of the device.

(2) **RoHS:** TI defines "RoHS" to mean semiconductor products that are compliant with the current EU RoHS requirements for all 10 RoHS substances, including the requirement that RoHS substance do not exceed 0.1% by weight in homogeneous materials. Where designed to be soldered at high temperatures, "RoHS" products are suitable for use in specified lead-free processes. TI may reference these types of products as "Pb-Free".

---

**RoHS Exempt:** TI defines "RoHS Exempt" to mean products that contain lead but are compliant with EU RoHS pursuant to a specific EU RoHS exemption.

**Green:** TI defines "Green" to mean the content of Chlorine (Cl) and Bromine (Br) based flame retardants meet JS709B low halogen requirements of <=1000ppm threshold. Antimony trioxide based flame retardants must also meet the <=1000ppm threshold requirement.

(3) MSL, Peak Temp. - The Moisture Sensitivity Level rating according to the JEDEC industry standard classifications, and peak solder temperature.

(4) There may be additional marking, which relates to the logo, the lot trace code information, or the environmental category on the device.

(5) Multiple Device Markings will be inside parentheses. Only one Device Marking contained in parentheses and separated by a "~" will appear on a device. If a line is indented then it is a continuation of the previous line and the two combined represent the entire Device Marking for that device.

(6) Lead/Ball Finish - Orderable Devices may have multiple material finish options. Finish options are separated by a vertical ruled line. Lead/Ball Finish values may wrap to two lines if the finish value exceeds the maximum column width.

**Important Information and Disclaimer:** The information provided on this page represents TI's knowledge and belief as of the date that it is provided. TI bases its knowledge and belief on information provided by third parties, and makes no representation or warranty as to the accuracy of such information. Efforts are underway to better integrate information from third parties. TI has taken and continues to take reasonable steps to provide representative and accurate information but may not have conducted destructive testing or chemical analysis on incoming materials and chemicals. TI and TI suppliers consider certain information to be proprietary, and thus CAS numbers and other limited information may not be available for release.

In no event shall TI's liability arising out of such information exceed the total purchase price of the TI part(s) at issue in this document sold by TI to Customer on an annual basis.

**OTHER QUALIFIED VERSIONS OF INA210, INA211, INA212, INA213, INA214, INA215 :**

- Automotive: [INA210-Q1](#), [INA211-Q1](#), [INA212-Q1](#), [INA213-Q1](#), [INA214-Q1](#), [INA215-Q1](#)

NOTE: Qualified Version Definitions:

- Automotive - Q100 devices qualified for high-reliability automotive applications targeting zero defects

## TAPE AND REEL INFORMATION



### QUADRANT ASSIGNMENTS FOR PIN 1 ORIENTATION IN TAPE



\*All dimensions are nominal

Device	Package Type	Package Drawing	Pins	SPQ	Reel Diameter (mm)	Reel Width W1 (mm)	A0 (mm)	B0 (mm)	K0 (mm)	P1 (mm)	W (mm)	Pin1 Quadrant
INA210AIDCKR	SC70	DCK	6	3000	178.0	9.0	2.4	2.5	1.2	4.0	8.0	Q3
INA210AIDCKR	SC70	DCK	6	3000	179.0	8.4	2.2	2.5	1.2	4.0	8.0	Q3
INA210AIDCKT	SC70	DCK	6	250	178.0	9.0	2.4	2.5	1.2	4.0	8.0	Q3
INA210AIDCKT	SC70	DCK	6	250	179.0	8.4	2.2	2.5	1.2	4.0	8.0	Q3
INA210AIRSWR	UQFN	RSW	10	3000	179.0	8.4	1.7	2.1	0.7	4.0	8.0	Q1
INA210AIRSWT	UQFN	RSW	10	250	179.0	8.4	1.7	2.1	0.7	4.0	8.0	Q1
INA210BIDCKR	SC70	DCK	6	3000	178.0	9.0	2.4	2.5	1.2	4.0	8.0	Q3
INA210BIDCKT	SC70	DCK	6	250	178.0	9.0	2.4	2.5	1.2	4.0	8.0	Q3
INA210BIRSWT	UQFN	RSW	10	250	179.0	8.4	1.7	2.1	0.7	4.0	8.0	Q1
INA210BIRSWT	UQFN	RSW	10	250	180.0	9.5	1.6	2.0	0.8	4.0	8.0	Q1
INA210CIDCKR	SC70	DCK	6	3000	178.0	9.0	2.4	2.5	1.2	4.0	8.0	Q3
INA210CIDCKT	SC70	DCK	6	250	178.0	9.0	2.4	2.5	1.2	4.0	8.0	Q3
INA210CIRSWR	UQFN	RSW	10	3000	180.0	9.5	1.6	2.0	0.8	4.0	8.0	Q1
INA210CIRSWR	UQFN	RSW	10	3000	179.0	8.4	1.7	2.1	0.7	4.0	8.0	Q1
INA210CIRSWT	UQFN	RSW	10	250	180.0	9.5	1.6	2.0	0.8	4.0	8.0	Q1
INA210CIRSWT	UQFN	RSW	10	250	179.0	8.4	1.7	2.1	0.7	4.0	8.0	Q1
INA211AIDCKR	SC70	DCK	6	3000	180.0	8.4	2.47	2.3	1.25	4.0	8.0	Q3
INA211AIDCKR	SC70	DCK	6	3000	178.0	9.0	2.4	2.5	1.2	4.0	8.0	Q3

Device	Package Type	Package Drawing	Pins	SPQ	Reel Diameter (mm)	Reel Width W1 (mm)	A0 (mm)	B0 (mm)	K0 (mm)	P1 (mm)	W (mm)	Pin1 Quadrant
INA211AIDCKR	SC70	DCK	6	3000	179.0	8.4	2.2	2.5	1.2	4.0	8.0	Q3
INA211AIDCKT	SC70	DCK	6	250	179.0	8.4	2.2	2.5	1.2	4.0	8.0	Q3
INA211AIDCKT	SC70	DCK	6	250	178.0	9.0	2.4	2.5	1.2	4.0	8.0	Q3
INA211AIDCKT	SC70	DCK	6	250	180.0	8.4	2.47	2.3	1.25	4.0	8.0	Q3
INA211BIDCKR	SC70	DCK	6	3000	178.0	9.0	2.4	2.5	1.2	4.0	8.0	Q3
INA211BIDCKT	SC70	DCK	6	250	178.0	9.0	2.4	2.5	1.2	4.0	8.0	Q3
INA211BIRSWR	UQFN	RSW	10	3000	179.0	8.4	1.7	2.1	0.7	4.0	8.0	Q1
INA211BIRSWT	UQFN	RSW	10	250	179.0	8.4	1.7	2.1	0.7	4.0	8.0	Q1
INA211CIDCKR	SC70	DCK	6	3000	178.0	9.0	2.4	2.5	1.2	4.0	8.0	Q3
INA211CIDCKT	SC70	DCK	6	250	178.0	9.0	2.4	2.5	1.2	4.0	8.0	Q3
INA211CIRSWR	UQFN	RSW	10	3000	180.0	9.5	1.6	2.0	0.8	4.0	8.0	Q1
INA211CIRSWR	UQFN	RSW	10	3000	179.0	8.4	1.7	2.1	0.7	4.0	8.0	Q1
INA211CIRSWT	UQFN	RSW	10	250	180.0	9.5	1.6	2.0	0.8	4.0	8.0	Q1
INA211CIRSWT	UQFN	RSW	10	250	179.0	8.4	1.7	2.1	0.7	4.0	8.0	Q1
INA212AIDCKR	SC70	DCK	6	3000	180.0	8.4	2.47	2.3	1.25	4.0	8.0	Q3
INA212AIDCKT	SC70	DCK	6	250	180.0	8.4	2.41	2.41	1.2	4.0	8.0	Q3
INA212BIDCKR	SC70	DCK	6	3000	178.0	9.0	2.4	2.5	1.2	4.0	8.0	Q3
INA212BIDCKT	SC70	DCK	6	250	178.0	9.0	2.4	2.5	1.2	4.0	8.0	Q3
INA212BIRSWR	UQFN	RSW	10	3000	180.0	9.5	1.6	2.0	0.8	4.0	8.0	Q1
INA212BIRSWR	UQFN	RSW	10	3000	179.0	8.4	1.7	2.1	0.7	4.0	8.0	Q1
INA212BIRSWT	UQFN	RSW	10	250	180.0	9.5	1.6	2.0	0.8	4.0	8.0	Q1
INA212BIRSWT	UQFN	RSW	10	250	179.0	8.4	1.7	2.1	0.7	4.0	8.0	Q1
INA212CIDCKR	SC70	DCK	6	3000	178.0	9.0	2.4	2.5	1.2	4.0	8.0	Q3
INA212CIDCKT	SC70	DCK	6	250	178.0	9.0	2.4	2.5	1.2	4.0	8.0	Q3
INA212CIRSWR	UQFN	RSW	10	3000	179.0	8.4	1.7	2.1	0.7	4.0	8.0	Q1
INA212CIRSWR	UQFN	RSW	10	3000	180.0	9.5	1.6	2.0	0.8	4.0	8.0	Q1
INA212CIRSWT	UQFN	RSW	10	250	180.0	9.5	1.6	2.0	0.8	4.0	8.0	Q1
INA212CIRSWT	UQFN	RSW	10	250	179.0	8.4	1.7	2.1	0.7	4.0	8.0	Q1
INA213AIDCKR	SC70	DCK	6	3000	178.0	9.0	2.4	2.5	1.2	4.0	8.0	Q3
INA213AIDCKR	SC70	DCK	6	3000	179.0	8.4	2.2	2.5	1.2	4.0	8.0	Q3
INA213AIDCKT	SC70	DCK	6	250	178.0	9.0	2.4	2.5	1.2	4.0	8.0	Q3
INA213AIDCKT	SC70	DCK	6	250	179.0	8.4	2.2	2.5	1.2	4.0	8.0	Q3
INA213AIRSWR	UQFN	RSW	10	3000	179.0	8.4	1.7	2.1	0.7	4.0	8.0	Q1
INA213AIRSWT	UQFN	RSW	10	250	179.0	8.4	1.7	2.1	0.7	4.0	8.0	Q1
INA213BIDCKR	SC70	DCK	6	3000	178.0	9.0	2.4	2.5	1.2	4.0	8.0	Q3
INA213BIDCKT	SC70	DCK	6	250	178.0	9.0	2.4	2.5	1.2	4.0	8.0	Q3
INA213BIRSWR	UQFN	RSW	10	3000	179.0	8.4	1.7	2.1	0.7	4.0	8.0	Q1
INA213BIRSWR	UQFN	RSW	10	3000	180.0	9.5	1.6	2.0	0.8	4.0	8.0	Q1
INA213BIRSWT	UQFN	RSW	10	250	180.0	9.5	1.6	2.0	0.8	4.0	8.0	Q1
INA213BIRSWT	UQFN	RSW	10	250	179.0	8.4	1.7	2.1	0.7	4.0	8.0	Q1
INA213CIDCKR	SC70	DCK	6	3000	178.0	9.0	2.4	2.5	1.2	4.0	8.0	Q3
INA213CIDCKT	SC70	DCK	6	250	178.0	9.0	2.4	2.5	1.2	4.0	8.0	Q3
INA213CIRSWR	UQFN	RSW	10	3000	179.0	8.4	1.7	2.1	0.7	4.0	8.0	Q1

Device	Package Type	Package Drawing	Pins	SPQ	Reel Diameter (mm)	Reel Width W1 (mm)	A0 (mm)	B0 (mm)	K0 (mm)	P1 (mm)	W (mm)	Pin1 Quadrant
INA213CIRSWR	UQFN	RSW	10	3000	180.0	9.5	1.6	2.0	0.8	4.0	8.0	Q1
INA213CIRSWT	UQFN	RSW	10	250	180.0	9.5	1.6	2.0	0.8	4.0	8.0	Q1
INA213CIRSWT	UQFN	RSW	10	250	179.0	8.4	1.7	2.1	0.7	4.0	8.0	Q1
INA214AIDCKR	SC70	DCK	6	3000	179.0	8.4	2.2	2.5	1.2	4.0	8.0	Q3
INA214AIDCKR	SC70	DCK	6	3000	178.0	9.0	2.4	2.5	1.2	4.0	8.0	Q3
INA214AIDCKT	SC70	DCK	6	250	178.0	9.0	2.4	2.5	1.2	4.0	8.0	Q3
INA214AIDCKT	SC70	DCK	6	250	179.0	8.4	2.2	2.5	1.2	4.0	8.0	Q3
INA214AIRSWR	UQFN	RSW	10	3000	179.0	8.4	1.7	2.1	0.7	4.0	8.0	Q1
INA214AIRSWT	UQFN	RSW	10	250	179.0	8.4	1.7	2.1	0.7	4.0	8.0	Q1
INA214BIDCKR	SC70	DCK	6	3000	178.0	9.0	2.4	2.5	1.2	4.0	8.0	Q3
INA214BIDCKT	SC70	DCK	6	250	178.0	9.0	2.4	2.5	1.2	4.0	8.0	Q3
INA214BIRSWR	UQFN	RSW	10	3000	179.0	8.4	1.7	2.1	0.7	4.0	8.0	Q1
INA214BIRSWR	UQFN	RSW	10	3000	180.0	9.5	1.6	2.0	0.8	4.0	8.0	Q1
INA214BIRSWT	UQFN	RSW	10	250	180.0	9.5	1.6	2.0	0.8	4.0	8.0	Q1
INA214BIRSWT	UQFN	RSW	10	250	179.0	8.4	1.7	2.1	0.7	4.0	8.0	Q1
INA214CIDCKR	SC70	DCK	6	3000	178.0	9.0	2.4	2.5	1.2	4.0	8.0	Q3
INA214CIDCKT	SC70	DCK	6	250	178.0	9.0	2.4	2.5	1.2	4.0	8.0	Q3
INA214CIRSWR	UQFN	RSW	10	3000	179.0	8.4	1.7	2.1	0.7	4.0	8.0	Q1
INA214CIRSWR	UQFN	RSW	10	3000	180.0	9.5	1.6	2.0	0.8	4.0	8.0	Q1
INA214CIRSWT	UQFN	RSW	10	250	179.0	8.4	1.7	2.1	0.7	4.0	8.0	Q1
INA214CIRSWT	UQFN	RSW	10	250	180.0	9.5	1.6	2.0	0.8	4.0	8.0	Q1
INA215AIDCKR	SC70	DCK	6	3000	178.0	8.4	2.4	2.5	1.2	4.0	8.0	Q3
INA215AIDCKT	SC70	DCK	6	250	178.0	9.0	2.4	2.5	1.2	4.0	8.0	Q3
INA215BIDCKR	SC70	DCK	6	3000	178.0	9.0	2.4	2.5	1.2	4.0	8.0	Q3
INA215BIDCKT	SC70	DCK	6	250	178.0	9.0	2.4	2.5	1.2	4.0	8.0	Q3
INA215BIRSWR	UQFN	RSW	10	3000	180.0	9.5	1.6	2.0	0.8	4.0	8.0	Q1
INA215BIRSWR	UQFN	RSW	10	3000	179.0	8.4	1.7	2.1	0.7	4.0	8.0	Q1
INA215BIRSWT	UQFN	RSW	10	250	179.0	8.4	1.7	2.1	0.7	4.0	8.0	Q1
INA215BIRSWT	UQFN	RSW	10	250	180.0	9.5	1.6	2.0	0.8	4.0	8.0	Q1
INA215CIDCKR	SC70	DCK	6	3000	178.0	9.0	2.4	2.5	1.2	4.0	8.0	Q3
INA215CIDCKT	SC70	DCK	6	250	178.0	9.0	2.4	2.5	1.2	4.0	8.0	Q3
INA215CIRSWR	UQFN	RSW	10	3000	180.0	9.5	1.6	2.0	0.8	4.0	8.0	Q1
INA215CIRSWR	UQFN	RSW	10	3000	179.0	8.4	1.7	2.1	0.7	4.0	8.0	Q1
INA215CIRSWT	UQFN	RSW	10	250	179.0	8.4	1.7	2.1	0.7	4.0	8.0	Q1
INA215CIRSWT	UQFN	RSW	10	250	180.0	9.5	1.6	2.0	0.8	4.0	8.0	Q1

**TAPE AND REEL BOX DIMENSIONS**

\*All dimensions are nominal

Device	Package Type	Package Drawing	Pins	SPQ	Length (mm)	Width (mm)	Height (mm)
INA210AIDCKR	SC70	DCK	6	3000	180.0	180.0	18.0
INA210AIDCKR	SC70	DCK	6	3000	195.0	200.0	45.0
INA210AIDCKT	SC70	DCK	6	250	180.0	180.0	18.0
INA210AIDCKT	SC70	DCK	6	250	195.0	200.0	45.0
INA210AIRSWR	UQFN	RSW	10	3000	203.0	203.0	35.0
INA210AIRSWT	UQFN	RSW	10	250	203.0	203.0	35.0
INA210BIDCKR	SC70	DCK	6	3000	180.0	180.0	18.0
INA210BIDCKT	SC70	DCK	6	250	180.0	180.0	18.0
INA210BIRSWT	UQFN	RSW	10	250	203.0	203.0	35.0
INA210BIRSWT	UQFN	RSW	10	250	189.0	185.0	36.0
INA210CIDCKR	SC70	DCK	6	3000	340.0	340.0	38.0
INA210CIDCKT	SC70	DCK	6	250	340.0	340.0	38.0
INA210CIRSWR	UQFN	RSW	10	3000	189.0	185.0	36.0
INA210CIRSWR	UQFN	RSW	10	3000	203.0	203.0	35.0
INA210CIRSWT	UQFN	RSW	10	250	189.0	185.0	36.0
INA210CIRSWT	UQFN	RSW	10	250	203.0	203.0	35.0
INA211AIDCKR	SC70	DCK	6	3000	223.0	270.0	35.0
INA211AIDCKR	SC70	DCK	6	3000	180.0	180.0	18.0
INA211AIDCKR	SC70	DCK	6	3000	195.0	200.0	45.0
INA211AIDCKT	SC70	DCK	6	250	195.0	200.0	45.0

Device	Package Type	Package Drawing	Pins	SPQ	Length (mm)	Width (mm)	Height (mm)
INA211AIDCKT	SC70	DCK	6	250	180.0	180.0	18.0
INA211AIDCKT	SC70	DCK	6	250	223.0	270.0	35.0
INA211BIDCKR	SC70	DCK	6	3000	180.0	180.0	18.0
INA211BIDCKT	SC70	DCK	6	250	180.0	180.0	18.0
INA211BIRSWR	UQFN	RSW	10	3000	203.0	203.0	35.0
INA211BIRSWT	UQFN	RSW	10	250	203.0	203.0	35.0
INA211CIDCKR	SC70	DCK	6	3000	340.0	340.0	38.0
INA211CIDCKT	SC70	DCK	6	250	340.0	340.0	38.0
INA211CIRSWR	UQFN	RSW	10	3000	189.0	185.0	36.0
INA211CIRSWR	UQFN	RSW	10	3000	203.0	203.0	35.0
INA211CIRSWT	UQFN	RSW	10	250	189.0	185.0	36.0
INA211CIRSWT	UQFN	RSW	10	250	203.0	203.0	35.0
INA212AIDCKR	SC70	DCK	6	3000	223.0	270.0	35.0
INA212AIDCKT	SC70	DCK	6	250	223.0	270.0	35.0
INA212BIDCKR	SC70	DCK	6	3000	180.0	180.0	18.0
INA212BIDCKT	SC70	DCK	6	250	180.0	180.0	18.0
INA212BIRSWR	UQFN	RSW	10	3000	189.0	185.0	36.0
INA212BIRSWR	UQFN	RSW	10	3000	203.0	203.0	35.0
INA212BIRSWT	UQFN	RSW	10	250	189.0	185.0	36.0
INA212BIRSWT	UQFN	RSW	10	250	203.0	203.0	35.0
INA212CIDCKR	SC70	DCK	6	3000	340.0	340.0	38.0
INA212CIDCKT	SC70	DCK	6	250	340.0	340.0	38.0
INA212CIRSWR	UQFN	RSW	10	3000	203.0	203.0	35.0
INA212CIRSWR	UQFN	RSW	10	3000	189.0	185.0	36.0
INA212CIRSWT	UQFN	RSW	10	250	189.0	185.0	36.0
INA212CIRSWT	UQFN	RSW	10	250	203.0	203.0	35.0
INA213AIDCKR	SC70	DCK	6	3000	180.0	180.0	18.0
INA213AIDCKR	SC70	DCK	6	3000	195.0	200.0	45.0
INA213AIDCKT	SC70	DCK	6	250	180.0	180.0	18.0
INA213AIDCKT	SC70	DCK	6	250	195.0	200.0	45.0
INA213AIRSWR	UQFN	RSW	10	3000	203.0	203.0	35.0
INA213AIRSWT	UQFN	RSW	10	250	203.0	203.0	35.0
INA213BIDCKR	SC70	DCK	6	3000	180.0	180.0	18.0
INA213BIDCKT	SC70	DCK	6	250	180.0	180.0	18.0
INA213BIRSWR	UQFN	RSW	10	3000	203.0	203.0	35.0
INA213BIRSWR	UQFN	RSW	10	3000	189.0	185.0	36.0
INA213BIRSWT	UQFN	RSW	10	250	189.0	185.0	36.0
INA213BIRSWT	UQFN	RSW	10	250	203.0	203.0	35.0
INA213CIDCKR	SC70	DCK	6	3000	340.0	340.0	38.0
INA213CIDCKT	SC70	DCK	6	250	340.0	340.0	38.0
INA213CIRSWR	UQFN	RSW	10	3000	203.0	203.0	35.0
INA213CIRSWR	UQFN	RSW	10	3000	189.0	185.0	36.0
INA213CIRSWT	UQFN	RSW	10	250	189.0	185.0	36.0
INA213CIRSWT	UQFN	RSW	10	250	203.0	203.0	35.0

Device	Package Type	Package Drawing	Pins	SPQ	Length (mm)	Width (mm)	Height (mm)
INA214AIDCKR	SC70	DCK	6	3000	195.0	200.0	45.0
INA214AIDCKR	SC70	DCK	6	3000	180.0	180.0	18.0
INA214AIDCKT	SC70	DCK	6	250	180.0	180.0	18.0
INA214AIDCKT	SC70	DCK	6	250	195.0	200.0	45.0
INA214AIRSWR	UQFN	RSW	10	3000	203.0	203.0	35.0
INA214AIRSWT	UQFN	RSW	10	250	203.0	203.0	35.0
INA214BIDCKR	SC70	DCK	6	3000	180.0	180.0	18.0
INA214BIDCKT	SC70	DCK	6	250	180.0	180.0	18.0
INA214BIRSWR	UQFN	RSW	10	3000	203.0	203.0	35.0
INA214BIRSWR	UQFN	RSW	10	3000	189.0	185.0	36.0
INA214BIRSWT	UQFN	RSW	10	250	189.0	185.0	36.0
INA214BIRSWT	UQFN	RSW	10	250	203.0	203.0	35.0
INA214CIDCKR	SC70	DCK	6	3000	180.0	180.0	18.0
INA214CIDCKT	SC70	DCK	6	250	180.0	180.0	18.0
INA214CIRSWR	UQFN	RSW	10	3000	203.0	203.0	35.0
INA214CIRSWR	UQFN	RSW	10	3000	189.0	185.0	36.0
INA214CIRSWT	UQFN	RSW	10	250	203.0	203.0	35.0
INA214CIRSWT	UQFN	RSW	10	250	189.0	185.0	36.0
INA215AIDCKR	SC70	DCK	6	3000	340.0	340.0	38.0
INA215AIDCKT	SC70	DCK	6	250	340.0	340.0	38.0
INA215BIDCKR	SC70	DCK	6	3000	340.0	340.0	38.0
INA215BIDCKT	SC70	DCK	6	250	340.0	340.0	38.0
INA215BIRSWR	UQFN	RSW	10	3000	189.0	185.0	36.0
INA215BIRSWR	UQFN	RSW	10	3000	203.0	203.0	35.0
INA215BIRSWT	UQFN	RSW	10	250	203.0	203.0	35.0
INA215BIRSWT	UQFN	RSW	10	250	189.0	185.0	36.0
INA215CIDCKR	SC70	DCK	6	3000	340.0	340.0	38.0
INA215CIDCKT	SC70	DCK	6	250	340.0	340.0	38.0
INA215CIRSWR	UQFN	RSW	10	3000	189.0	185.0	36.0
INA215CIRSWR	UQFN	RSW	10	3000	203.0	203.0	35.0
INA215CIRSWT	UQFN	RSW	10	250	203.0	203.0	35.0
INA215CIRSWT	UQFN	RSW	10	250	189.0	185.0	36.0

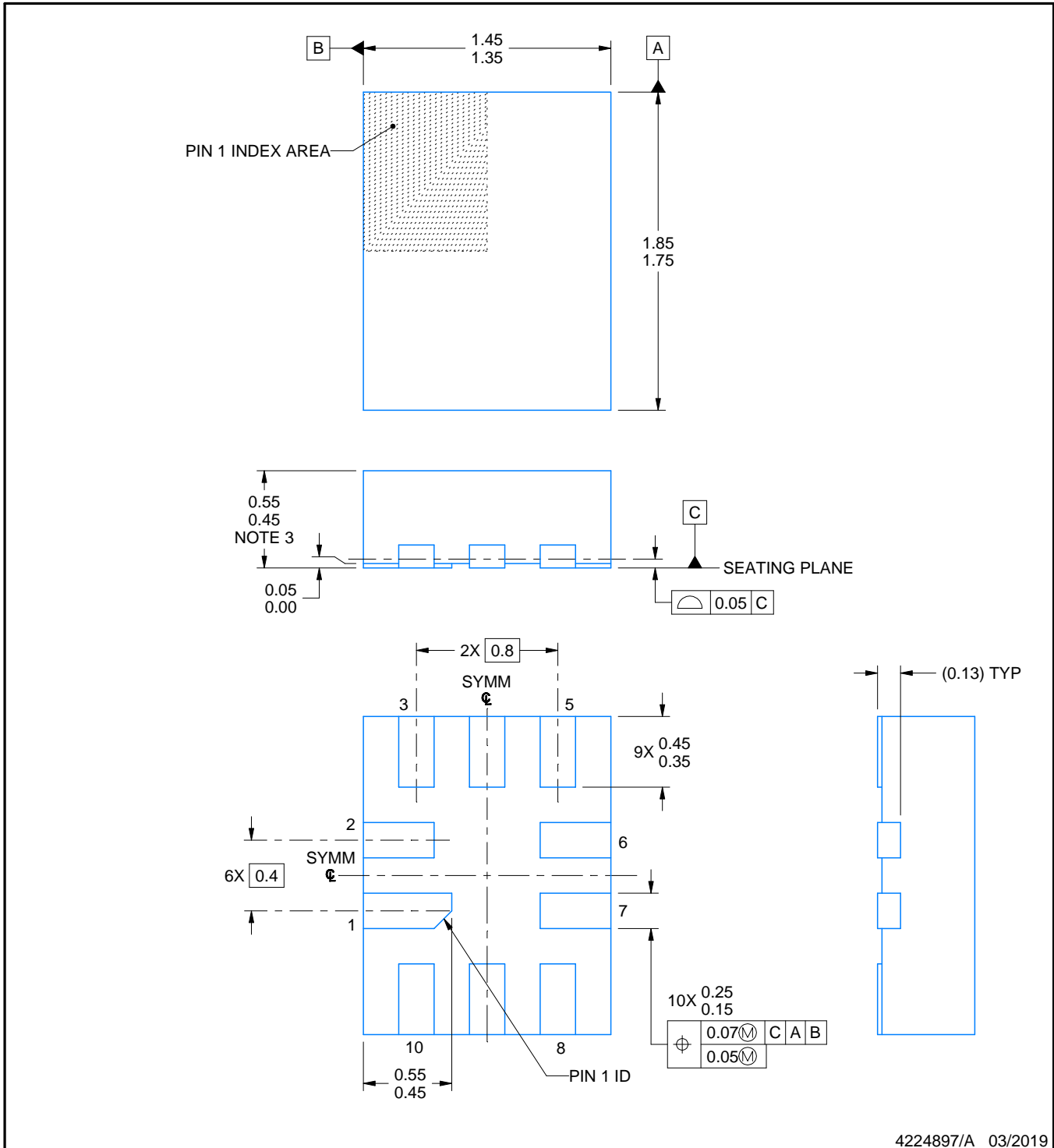

4224897/A 03/2019

NOTES:

1. All linear dimensions are in millimeters. Any dimensions in parenthesis are for reference only. Dimensioning and tolerancing per ASME Y14.5M.
2. This drawing is subject to change without notice.
3. This package complies to JEDEC MO-288 variation UDEE, except minimum package height.

# EXAMPLE BOARD LAYOUT

RSW0010A

UQFN - 0.55 mm max height

PLASTIC QUAD FLATPACK - NO LEAD



LAND PATTERN EXAMPLE  
EXPOSED METAL SHOWN  
SCALE: 30X



SOLDER MASK DETAILS

4224897/A 03/2019

NOTES: (continued)

4. This package is designed to be soldered to a thermal pad on the board. For more information, see Texas Instruments literature number SLUA271 ([www.ti.com/lit/sluea271](http://www.ti.com/lit/sluea271)).
5. Vias are optional depending on application, refer to device data sheet. If any vias are implemented, refer to their locations shown on this view. It is recommended that vias under paste be filled, plugged or tented.

# EXAMPLE STENCIL DESIGN

RSW0010A

UQFN - 0.55 mm max height

PLASTIC QUAD FLATPACK - NO LEAD



SOLDER PASTE EXAMPLE  
BASED ON 0.125 MM THICK STENCIL  
SCALE: 30X

4224897/A 03/2019

NOTES: (continued)

6. Laser cutting apertures with trapezoidal walls and rounded corners may offer better paste release. IPC-7525 may have alternate design recommendations.

DCK (R-PDSO-G6)

PLASTIC SMALL-OUTLINE PACKAGE



- NOTES:
- A. All linear dimensions are in millimeters.
  - B. This drawing is subject to change without notice.
  - C. Body dimensions do not include mold flash or protrusion. Mold flash and protrusion shall not exceed 0.15 per side.
  - D. Falls within JEDEC MO-203 variation AB.

DCK (R-PDSO-G6)

PLASTIC SMALL OUTLINE

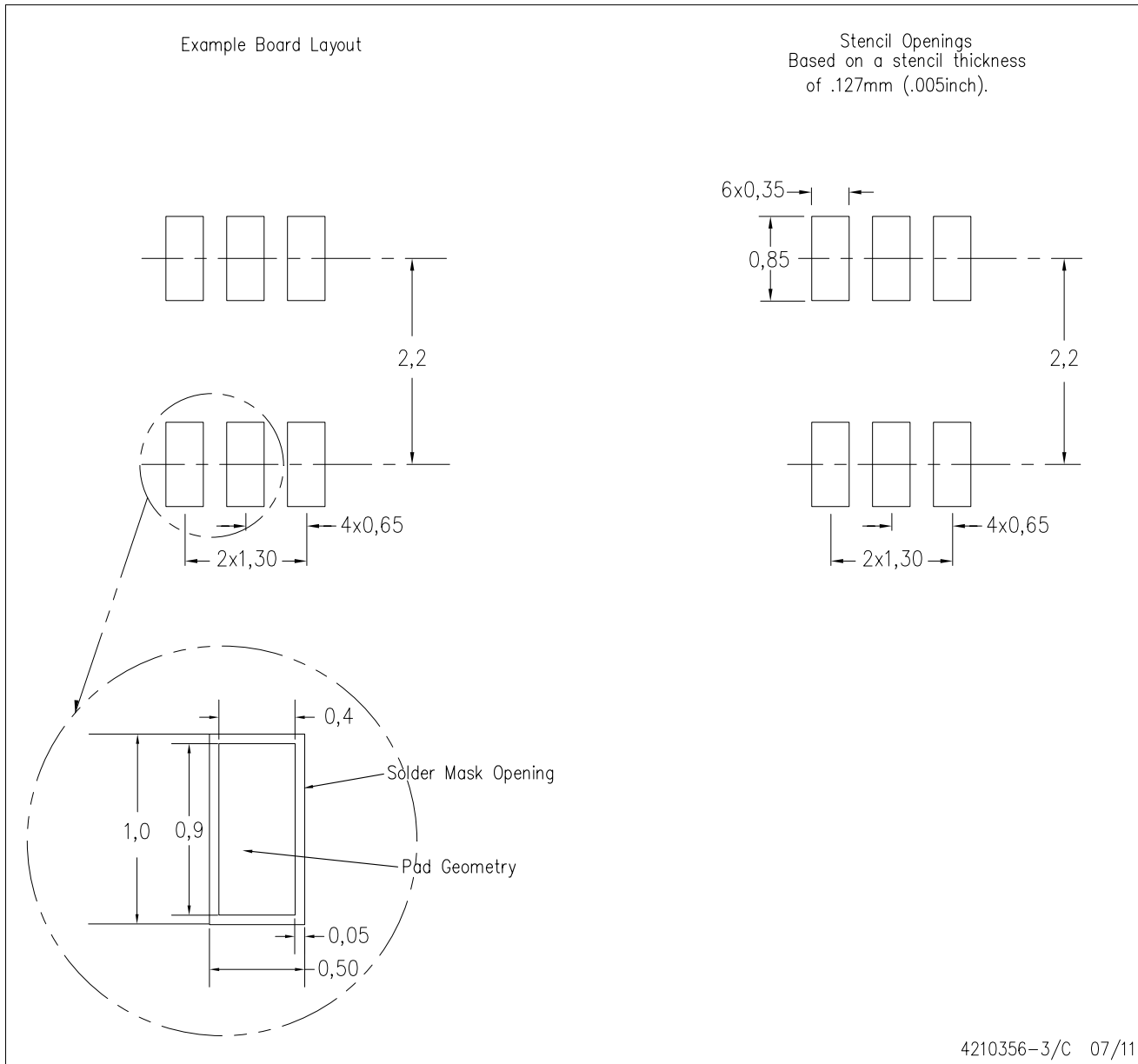

- NOTES:
- All linear dimensions are in millimeters.
  - This drawing is subject to change without notice.
  - Customers should place a note on the circuit board fabrication drawing not to alter the center solder mask defined pad.
  - Publication IPC-7351 is recommended for alternate designs.
  - Laser cutting apertures with trapezoidal walls and also rounding corners will offer better paste release. Customers should contact their board assembly site for stencil design recommendations. Example stencil design based on a 50% volumetric metal load solder paste. Refer to IPC-7525 for other stencil recommendations.

## IMPORTANT NOTICE AND DISCLAIMER

TI PROVIDES TECHNICAL AND RELIABILITY DATA (INCLUDING DATASHEETS), DESIGN RESOURCES (INCLUDING REFERENCE DESIGNS), APPLICATION OR OTHER DESIGN ADVICE, WEB TOOLS, SAFETY INFORMATION, AND OTHER RESOURCES "AS IS" AND WITH ALL FAULTS, AND DISCLAIMS ALL WARRANTIES, EXPRESS AND IMPLIED, INCLUDING WITHOUT LIMITATION ANY IMPLIED WARRANTIES OF MERCHANTABILITY, FITNESS FOR A PARTICULAR PURPOSE OR NON-INFRINGEMENT OF THIRD PARTY INTELLECTUAL PROPERTY RIGHTS.

These resources are intended for skilled developers designing with TI products. You are solely responsible for (1) selecting the appropriate TI products for your application, (2) designing, validating and testing your application, and (3) ensuring your application meets applicable standards, and any other safety, security, or other requirements. These resources are subject to change without notice. TI grants you permission to use these resources only for development of an application that uses the TI products described in the resource. Other reproduction and display of these resources is prohibited. No license is granted to any other TI intellectual property right or to any third party intellectual property right. TI disclaims responsibility for, and you will fully indemnify TI and its representatives against, any claims, damages, costs, losses, and liabilities arising out of your use of these resources.

TI's products are provided subject to TI's Terms of Sale ([www.ti.com/legal/termsofsale.html](http://www.ti.com/legal/termsofsale.html)) or other applicable terms available either on [ti.com](http://ti.com) or provided in conjunction with such TI products. TI's provision of these resources does not expand or otherwise alter TI's applicable warranties or warranty disclaimers for TI products.

Mailing Address: Texas Instruments, Post Office Box 655303, Dallas, Texas 75265  
Copyright © 2019, Texas Instruments Incorporated

## Looking for pricing, stock, or lifecycle information?

Click below to explore more details on WIN SOURCE:

 [View INA211BIRSWT](#) on WIN SOURCE

 [Texas Instruments](#) Information

## Optimize Your Supply Chain with WIN SOURCE Solutions

-  Global Sourcing Solution
-  Obsolete Management
-  Cost Control Management
-  Shortage Management
-  Alternative Solution
-  Excess Inventory Management