



**THE DATASHEET OF
KSB1116AYTA**



KSB1116/1116A

Audio Frequency Power Amplifier & Medium Speed Switching

- Complement to KSD1616/1616A

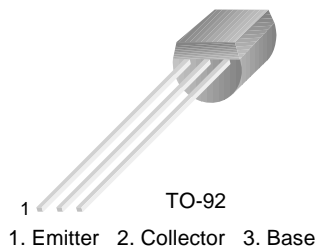

PNP Epitaxial Silicon Transistor

Absolute Maximum Ratings $T_a=25^\circ\text{C}$ unless otherwise noted

Symbol	Parameter	Ratings	Units	
V_{CBO}	Collector-Base Voltage	: KSB1116	-60	V
		: KSB1116A	-80	V
V_{CEO}	Collector-Emitter Voltage	: KSB1116	-50	V
		: KSB1116A	-60	V
V_{EBO}	Emitter-Base Voltage	-6	V	
I_C	Collector Current (DC)	-1	A	
I_{CP}	* Collector Current (Pulse)	-2	A	
P_C	Collector Power Dissipation	0.75	W	
T_J	Junction Temperature	150	$^\circ\text{C}$	
T_{STG}	Storage Temperature	-55 ~ 150	$^\circ\text{C}$	

* $PW \leq 10\text{ms}$, Duty Cycles $\leq 50\%$

Electrical Characteristics $T_a=25^\circ\text{C}$ unless otherwise noted

Symbol	Parameter	Test Condition	Min.	Typ.	Max.	Units
I_{CBO}	Collector Cut-off Current	$V_{CB} = -60\text{V}$, $I_E = 0$			-100	nA
I_{EBO}	Emitter Cut-off Current	$V_{EB} = -6\text{V}$, $I_C = 0$			-100	nA
h_{FE1}	* DC Current Gain : KSB1116 : KSB1116A	$V_{CE} = -2\text{V}$, $I_C = -100\text{mA}$	135		600	
h_{FE2}		$V_{CE} = -2\text{V}$, $I_C = -1\text{A}$	135		400	
$V_{BE(on)}$	* Base-Emitter On Voltage	$V_{CE} = -2\text{V}$, $I_C = -50\text{mA}$	-600	-650	-700	mV
$V_{CE(sat)}$	* Collector-Emitter Saturation Voltage	$I_C = -1\text{A}$, $I_B = -50\text{mA}$		-0.2	-0.3	V
$V_{BE(sat)}$	* Base-Emitter Saturation Voltage	$I_C = -1\text{A}$, $I_B = -50\text{mA}$		-0.9	-1.2	V
C_{ob}	Output Capacitance	$V_{CB} = -10\text{V}$, $I_E = 0$, $f = 1\text{MHz}$		25		pF
f_T	Current Gain Bandwidth Product	$V_{CE} = -2\text{V}$, $I_C = -100\text{mA}$	70	120		MHz
t_{ON}	Turn On Time	$V_{CC} = -10\text{V}$, $I_C = -100\text{mA}$		0.07		μs
t_{STG}	Storage Time	$I_{B1} = -I_{B2} = -10\text{mA}$		0.7		μs
t_F	Fall Time	$V_{BE(off)} = 2\sim 3\text{V}$		0.07		μs

* Pulse Test: $PW \leq 350\mu\text{s}$, Duty Cycle $\leq 2\%$

h_{FE} Classification

Classification	Y	G	L
h_{FE1}	135 ~ 270	200 ~ 400	300 ~ 600

Typical Characteristics

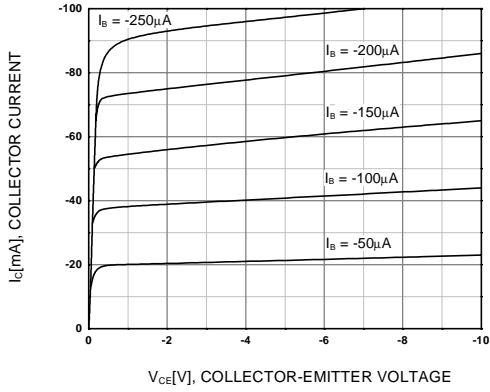

Figure 1. Static Characteristic

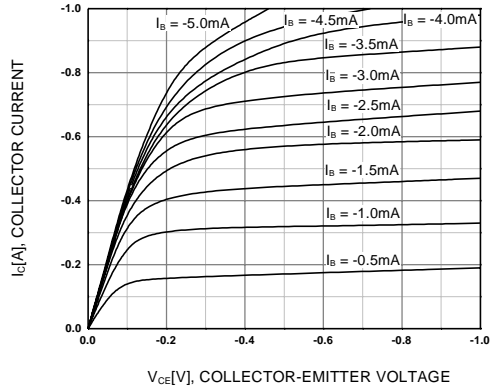

Figure 2. Static Characteristic

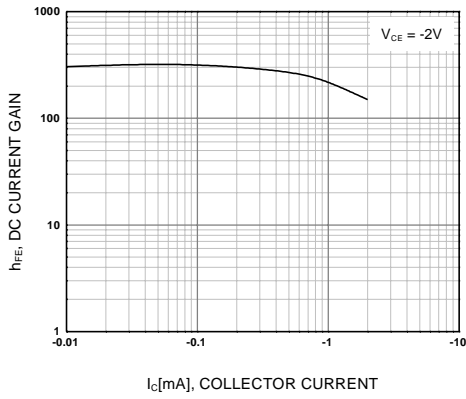

Figure 3. DC current Gain

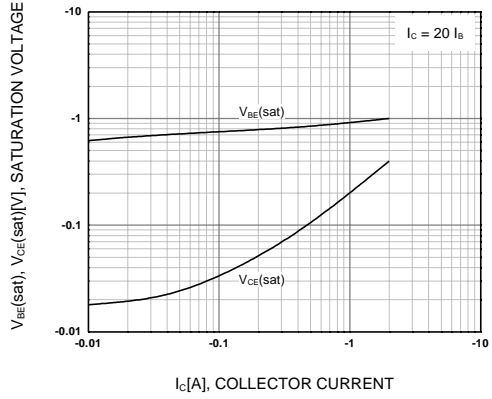

Figure 4. Base-Emitter Saturation Voltage
Collector-Emitter Saturation Voltage

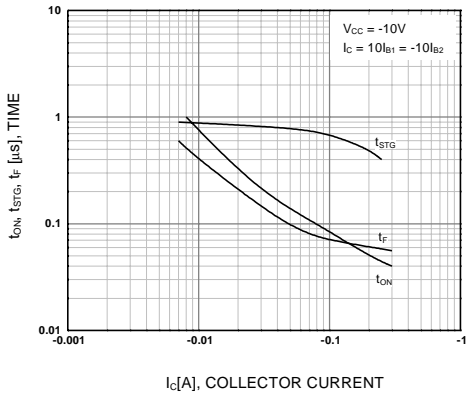

Figure 5. Switching Time

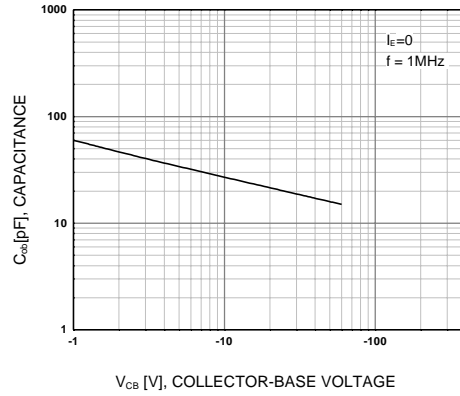

Figure 6. Collector Output Capacitance

Typical Characteristics (Continued)

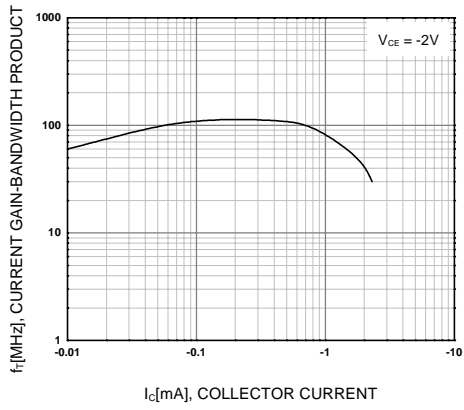

Figure 7. Current Gain Bandwidth Product

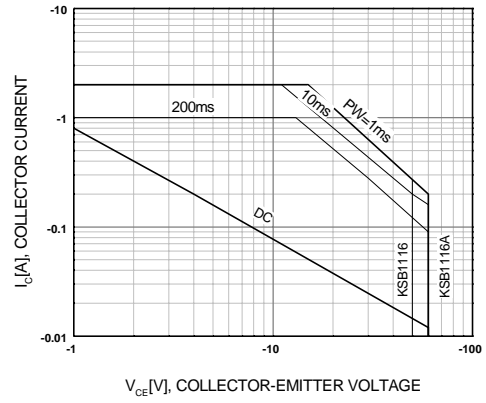

Figure 8. Safe Operating Area

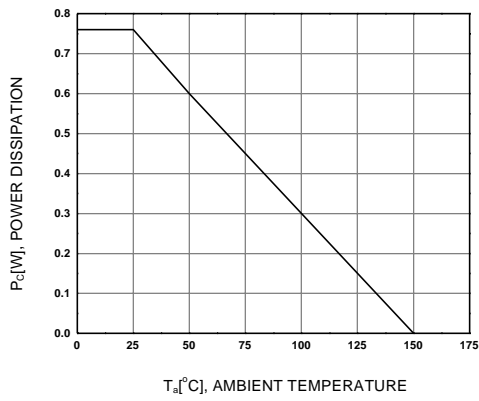
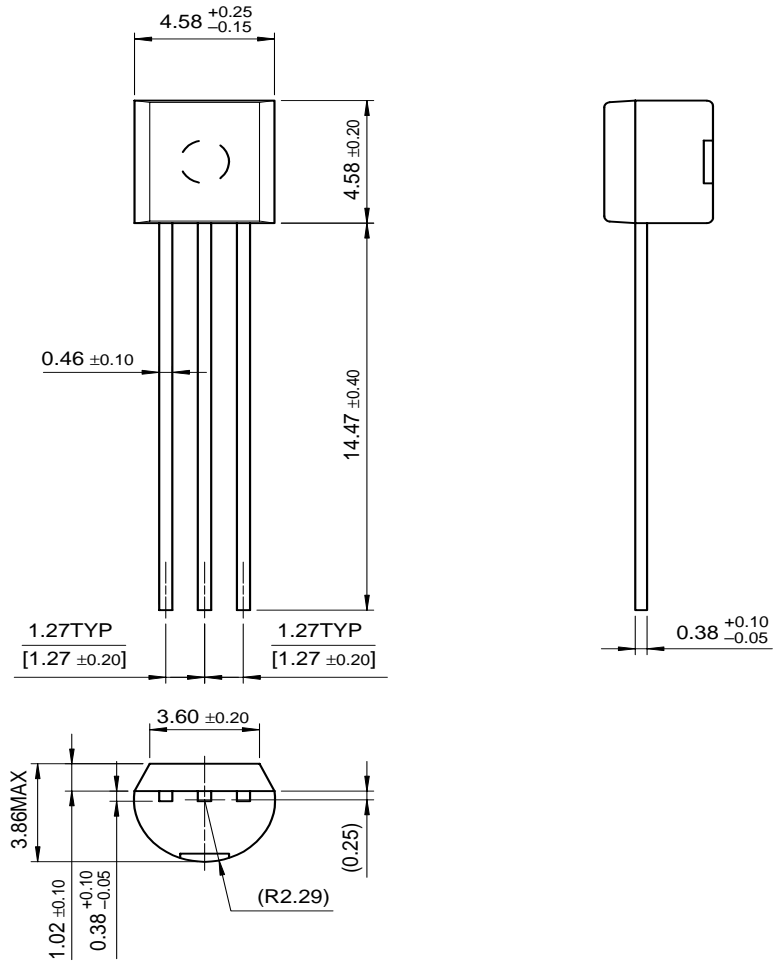

Figure 9. Power Derating

Package Dimensions

TO-92

KSB1116/1116A



Dimensions in Millimeters

TRADEMARKS

The following are registered and unregistered trademarks Fairchild Semiconductor owns or is authorized to use and is not intended to be an exhaustive list of all such trademarks.

ACE _x TM	FAST [®]	OPTOLOGIC TM	SMART START TM	VCX TM
Bottomless TM	FAST _r TM	OPTOPLANAR TM	STAR*POWER TM	
CoolFET TM	FRFET TM	PACMAN TM	Stealth TM	
CROSSVOLT TM	GlobalOptoisolator TM	POP TM	SuperSOT TM -3	
DenseTrench TM	GTO TM	Power247 TM	SuperSOT TM -6	
DOMET TM	HiSeC TM	PowerTrench [®]	SuperSOT TM -8	
EcoSPARK TM	ISOPLANAR TM	QFET TM	SyncFET TM	
E ² CMOS TM	LittleFET TM	QS TM	TruTranslation TM	
EnSigna TM	MicroFET TM	QT Optoelectronics TM	TinyLogic TM	
FACT TM	MicroPak TM	Quiet Series TM	UHC TM	
FACT Quiet Series TM	MICROWIRE TM	SLIENT SWITCHER [®]	UltraFET [®]	

STAR*POWER is used under license

DISCLAIMER

FAIRCHILD SEMICONDUCTOR RESERVES THE RIGHT TO MAKE CHANGES WITHOUT FURTHER NOTICE TO ANY PRODUCTS HEREIN TO IMPROVE RELIABILITY, FUNCTION OR DESIGN. FAIRCHILD DOES NOT ASSUME ANY LIABILITY ARISING OUT OF THE APPLICATION OR USE OF ANY PRODUCT OR CIRCUIT DESCRIBED HEREIN; NEITHER DOES IT CONVEY ANY LICENSE UNDER ITS PATENT RIGHTS, NOR THE RIGHTS OF OTHERS.

LIFE SUPPORT POLICY

FAIRCHILD'S PRODUCTS ARE NOT AUTHORIZED FOR USE AS CRITICAL COMPONENTS IN LIFE SUPPORT DEVICES OR SYSTEMS WITHOUT THE EXPRESS WRITTEN APPROVAL OF FAIRCHILD SEMICONDUCTOR CORPORATION.

As used herein:

1. Life support devices or systems are devices or systems which, (a) are intended for surgical implant into the body, or (b) support or sustain life, or (c) whose failure to perform when properly used in accordance with instructions for use provided in the labeling, can be reasonably expected to result in significant injury to the user.
2. A critical component is any component of a life support device or system whose failure to perform can be reasonably expected to cause the failure of the life support device or system, or to affect its safety or effectiveness.

PRODUCT STATUS DEFINITIONS

Definition of Terms

Datasheet Identification	Product Status	Definition
Advance Information	Formative or In Design	This datasheet contains the design specifications for product development. Specifications may change in any manner without notice.
Preliminary	First Production	This datasheet contains preliminary data, and supplementary data will be published at a later date. Fairchild Semiconductor reserves the right to make changes at any time without notice in order to improve design.
No Identification Needed	Full Production	This datasheet contains final specifications. Fairchild Semiconductor reserves the right to make changes at any time without notice in order to improve design.
Obsolete	Not In Production	This datasheet contains specifications on a product that has been discontinued by Fairchild semiconductor. The datasheet is printed for reference information only.

Looking for pricing, stock, or lifecycle information?

Click below to explore more details on WIN SOURCE:

 [View KSB1116AYTA on WIN SOURCE](#)

 [Fairchild/ON Semiconductor](#) Information

Optimize Your Supply Chain with WIN SOURCE Solutions

-  Global Sourcing Solution
-  Obsolete Management
-  Cost Control Management
-  Shortage Management
-  Alternative Solution
-  Excess Inventory Management