



**THE DATASHEET OF  
74LVC06AT14-13**



## HEX INVERTERS WITH OPEN DRAIN OUTPUTS

### Description

The 74LVC06A provides six independent open-drain inverter buffers. The device is designed for operation with a power supply range of 1.65V to 5.5V. The inputs are tolerant to 5.5V allowing this device to be used in a mixed voltage environment. The device is fully specified for partial power down applications using IOFF. The IOFF circuitry disables the output preventing damaging current backflow when the device is powered down. The outputs can be connected to implement active-low wired-OR or active-high wired-AND functions.

The gates perform the positive Boolean function:

$$Y = \overline{A}$$

### Features

- Wide Supply Voltage Range from 1.65V to 5.5V
- Sinks 24mA at V<sub>CC</sub> = 3.3V
- CMOS Low Power Consumption
- IOFF Supports Partial-Power-Down Mode Operation
- Inputs or Outputs Accept Up to 5.5V
- Inputs Can be Driven by 3.3V or 5.5V Allowing for Voltage Translation Applications.
- ESD Protection Exceeds JESD 22
  - 200-V Machine Model (A115-A)
  - 2000-V Human Body Model (A114-A)
  - Exceeds 1000-V Charged Device Model (C101C)
- Latch-Up Exceeds 250mA per JESD 78, Class II
- Range of Package Options SO-14 and TSSOP-14
- **Totally Lead-Free & Fully RoHS Compliant (Notes 1 & 2)**
- **Halogen and Antimony Free. "Green" Device (Note 3)**

Notes: 1. No purposely added lead. Fully EU Directive 2002/95/EC (RoHS) & 2011/65/EU (RoHS 2) compliant.  
 2. See <http://www.diodes.com> for more information about Diodes Incorporated's definitions of Halogen- and Antimony-free, "Green" and Lead-free.  
 3. Halogen- and Antimony-free "Green" products are defined as those which contain <900ppm bromine, <900ppm chlorine (<1500ppm total Br + Cl) and <1000ppm antimony compounds.

### Pin Assignments

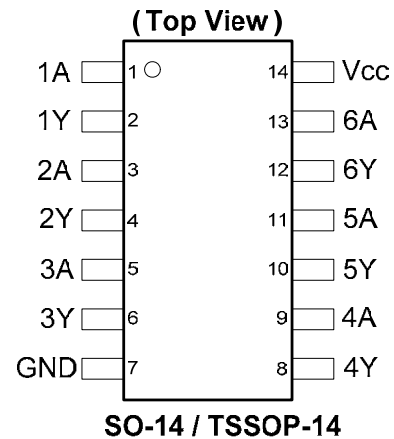

### Applications

- Voltage Level Shifting
- General Purpose Logic
- Power Down Signal Isolation
- Wide array of products such as:
  - PCs, networking, notebooks, ultrabooks, netbooks
  - Computer peripherals, hard drives, CD/DVD ROM
  - TV, DVD, DVR, set top box

**Pin Descriptions**

| Pin Number | Pin Name        | Description    |
|------------|-----------------|----------------|
| 1          | 1A              | Data Input     |
| 2          | 1Y              | Data Output    |
| 3          | 2A              | Data Input     |
| 4          | 2Y              | Data Output    |
| 5          | 3A              | Data Input     |
| 6          | 3Y              | Data Output    |
| 7          | GND             | Ground         |
| 8          | 4Y              | Data Output    |
| 9          | 4A              | Data Input     |
| 10         | 5Y              | Data Output    |
| 11         | 5A              | Data Input     |
| 12         | 6Y              | Data Output    |
| 13         | 6A              | Data Input     |
| 14         | V <sub>CC</sub> | Supply Voltage |

**Logic Diagram**

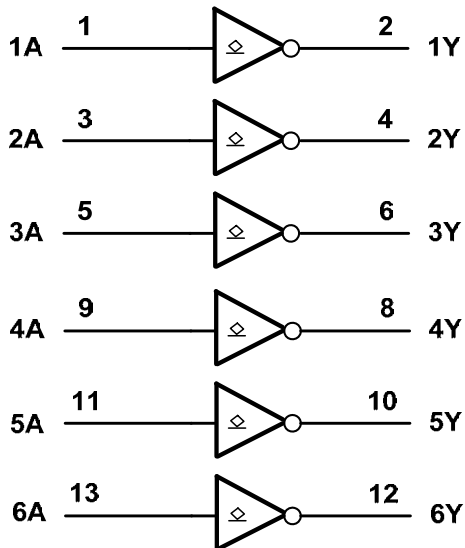

**Function Table**

| Inputs | Outputs |
|--------|---------|
| A      | Y       |
| H      | L       |
| L      | Z       |

---

### Absolute Maximum Ratings (Note 4) (@T<sub>A</sub> = +25°C, unless otherwise specified.)

---

| Symbol           | Description   | Rating                       | Unit |
|------------------|---|------------------------------|------|
| ESD HBM          | Human Body Model ESD Protection                                       | 2                            | KV   |
| ESD CDM          | Charged Device Model ESD Protection                                   | 1                            | KV   |
| ESD MM           | Machine Model ESD Protection  | 200                          | V    |
| V <sub>CC</sub>  | Supply Voltage Range  | -0.5 to +6.5                 | V    |
| V <sub>I</sub>   | Input Voltage Range   | -0.5 to +6.5                 | V    |
| V <sub>O</sub>   | Voltage applied to output in high impedance or I <sub>OFF</sub> state | -0.5 to +6.5                 | V    |
| V <sub>O</sub>   | Voltage applied to output in high or low state                        | -0.3 to V <sub>CC</sub> +0.5 | V    |
| I <sub>IK</sub>  | Input Clamp Current V <sub>I</sub> < 0                                | -50                          | mA   |
| I <sub>OK</sub>  | Output Clamp Current V <sub>O</sub> < 0                               | -50                          | mA   |
| I <sub>O</sub>   | Continuous Output Current   | 50                           | mA   |
|                  | Continuous current through V <sub>DD</sub> or GND                     | ±100                         | mA   |
| T <sub>J</sub>   | Operating Junction Temperature  | -40 to +150                  | °C   |
| T <sub>STG</sub> | Storage Temperature   | -65 to +150                  | °C   |
| P <sub>TOT</sub> | Total Power Dissipation   | 500                          | mW   |

Note: 4. Stresses beyond the absolute maximum may result in immediate failure or reduced reliability. These are stress values and device operation should be within recommend values.

---

### Recommended Operating Conditions (Note 5) (@T<sub>A</sub> = +25°C, unless otherwise specified.)

---

| Symbol          | Parameter                          | Conditions                            | Min  | Max             | Unit |
|-----------------|------------------------------------|---------------------------------------|------|-----------------|------|
| V <sub>CC</sub> | Supply Voltage                     |                                       | 1.65 | 5.5             | V    |
| V <sub>I</sub>  | Input Voltage                      |                                       | 0    | 5.5             | V    |
| V <sub>O</sub>  | Output Voltage                     | Active Mode                           | 0    | V <sub>CC</sub> | V    |
|                 |                                    | V <sub>CC</sub> = 0V; Power Down Mode | 0    | 5.5             | V    |
| Δt/ΔV           | Input transition rise or fall rate | V <sub>CC</sub> = 1.65V to 2.7V       |      | 20              | ns/V |
|                 |                                    | V <sub>CC</sub> = 2.7V to 5.5V        |      | 10              |      |
| T <sub>A</sub>  | Operating free-air temperature     |                                       | -40  | +125            | °C   |

Notes: 5. Unused inputs should be held at V<sub>CC</sub> or Ground.

---

**Electrical Characteristics** (@T<sub>A</sub> = +25°C, unless otherwise specified.)
 

---

| Symbol           | Parameter                  | Test Conditions  | V <sub>CC</sub> | T <sub>A</sub> = -40°C to +85°C |                        | T <sub>A</sub> = -40°C to +125°C |                        | Unit |
|------------------|----------------------------|--|-----------------|---------------------------------|------------------------|----------------------------------|------------------------|------|
|                  |                            |  |                 | Min                             | Max                    | Min                              | Max                    |      |
| V <sub>IH</sub>  | High-level Input Voltage   |  | 1.65V to 1.95V  | 0.65 X V <sub>CC</sub>          |                        | 0.65 X V <sub>CC</sub>           |                        | V    |
|                  |                            |  | 2.3V to 2.7V    | 1.7                             |                        | 1.6                              |                        |      |
|                  |                            |  | 2.7V to 3.6V    | 2.0                             |                        | 2.0                              |                        |      |
|                  |                            |  | 4.5V to 5.5V    | 0.7 X V <sub>CC</sub>           |                        | 2.0                              |                        |      |
| V <sub>IL</sub>  | Low-level input voltage    |  | 1.65V to 1.95V  |                                 | 0.35 X V <sub>CC</sub> |                                  | 0.35 X V <sub>CC</sub> | V    |
|                  |                            |  | 2.3V to 2.7V    |                                 | 0.7                    |                                  | 0.7                    |      |
|                  |                            |  | 2.7V to 3.6V    |                                 | 0.8                    |                                  | 0.8                    |      |
|                  |                            |  | 4.5V to 5.5V    |                                 | 0.3 X V <sub>CC</sub>  |                                  | 0.3 X V <sub>CC</sub>  |      |
| V <sub>OL</sub>  | Low-level Output Voltage   | I <sub>OL</sub> = 100μA                                      | 1.65V to 5.5V   |                                 | 0.2                    |                                  | 0.3                    | V    |
|                  |                            | I <sub>OL</sub> = 4mA  | 1.65V           |                                 | 0.45                   |                                  | 0.6                    |      |
|                  |                            | I <sub>OL</sub> = 8mA  | 2.3V            |                                 | 0.70                   |                                  | 0.85                   |      |
|                  |                            | I <sub>OL</sub> = 12mA                                       | 2.7V            |                                 | 0.40                   |                                  | 0.6                    |      |
|                  |                            |  | 3.0V            |                                 | 0.55                   |                                  | 0.6                    |      |
|                  |                            | I <sub>OL</sub> = 24mA                                       | 3.0V            |                                 | 0.55                   |                                  | 0.6                    |      |
|                  |                            | I <sub>OL</sub> = 32mA                                       | 4.5V            |                                 | 0.55                   |                                  | 0.6                    |      |
| I <sub>OZ</sub>  | Z State Leakage Current    | V <sub>O</sub> = GND or 5.5V                                 | 3.6V            |                                 | ±10                    |                                  | ±20                    | μA   |
| I <sub>I</sub>   | Input Current              | V <sub>I</sub> = GND to 5.5V                                 | 3.6V            |                                 | ± 5                    |                                  | ± 20                   | μA   |
| I <sub>OFF</sub> | Power Down Leakage Current | V <sub>I</sub> or V <sub>O</sub> = 0V to 3.6V                | 0               |                                 | 10                     |                                  | 20                     | μA   |
| I <sub>CC</sub>  | Supply Current             | V <sub>I</sub> = GND or V <sub>CC</sub><br>I <sub>O</sub> =0 | 3.6V            |                                 | 10                     |                                  | 40                     | μA   |

## Switching Characteristics

| Symbol                             | Parameter  | Test Conditions | V <sub>CC</sub> | T <sub>A</sub> = +25°C |     |     | -40°C to +85°C |     | -40°C to +125°C |     | Unit |
|------------------------------------|--|-----------------|-----------------|------------------------|-----|-----|----------------|-----|-----------------|-----|------|
|                                    |  |                 |                 | Min                    | Typ | Max | Min            | Max | Min             | Max |      |
| t <sub>PLZ</sub> /t <sub>PZL</sub> | Propagation Delay A <sub>N</sub> to Y <sub>N</sub> | Figure 1        | 1.65V to 1.95V  | 0.3                    | 2.9 | 5.3 | 0.3            | 5.6 | 0.3             | 7.6 | ns   |
|                                    |  |                 | 2.3V to 2.7V    | 0.3                    | 2.6 | 4.1 | 0.3            | 4.7 | 0.3             | 5.5 |      |
|                                    |  |                 | 2.7V            | 0.3                    | 2.5 | 4.0 | 0.3            | 4.5 | 0.3             | 5.0 |      |
|                                    |  |                 | 3V to 3.6V      | 0.3                    | 2.3 | 3.5 | 0.3            | 3.7 | 0.3             | 5.0 |      |
|                                    |  |                 | 4.5V to 5.5V    | 0.3                    | 1.7 | 2.5 | 0.3            | 3.4 | 0.3             | 4.5 |      |

## Operating Characteristics (@T<sub>A</sub> = +25°C, unless otherwise specified.)

| Parameter       |  | Test Conditions                           | V <sub>CC</sub> = 1.8V | V <sub>CC</sub> = 2.5V | V <sub>CC</sub> = 3.3V | V <sub>CC</sub> = 5V | Unit |
|-----------------|--|---|------------------------|------------------------|------------------------|----------------------|------|
|                 |  |   | Typ                    | Typ                    | Typ                    | Typ                  |      |
| C <sub>pd</sub> | Power dissipation capacitance per gate | f = 10 MHz                                | 7.0                    | 7.5                    | 8.0                    | 8.6                  | pF   |
| C <sub>I</sub>  | Input Capacitance                      | V <sub>I</sub> = V <sub>CC</sub> – or GND | 4                      | 4                      | 4                      | 4                    | pF   |

## Package Characteristics

| Symbol          | Parameter                              | Test Conditions | V <sub>CC</sub> | Min | Typ | Max | Unit |
|-----------------|--|-----------------|-----------------|-----|-----|-----|------|
| θ <sub>JA</sub> | Thermal Resistance Junction-to-Ambient | SO-14           | (Note 6)        |     | TBD |     | °C/W |
|                 |  | TSSOP-14        |                 |     | 159 |     |      |
| θ <sub>JC</sub> | Thermal Resistance Junction-to-Case    | SO-14           | (Note 6)        |     | TBD |     | °C/W |
|                 |  | TSSOP-14        |                 |     | 25  |     |      |

Note: 6. Test condition for SO-14 and TSSOP-14: Device mounted on FR-4 substrate PC board, 2oz copper, with minimum recommended pad layout.

**Parameter Measurement Information**

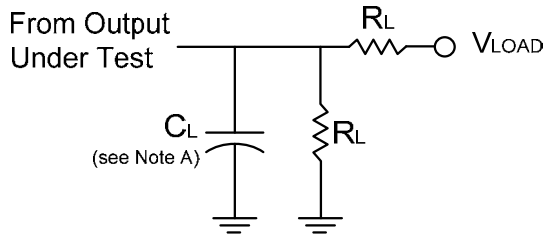

| TEST                   | Condition  |
|------------------------|------------|
| $t_{PLZ}$ (see Note E) | $V_{LOAD}$ |
| $t_{PZL}$ (see Note D) | $V_{LOAD}$ |

| $V_{CC}$         | Inputs   |              | $V_M$      | $V_{LOAD}$        | $C_L$ | $R_L$        | $V_{\Delta}$ |
|------------------|----------|--------------|------------|-------------------|-------|--------------|--------------|
|                  | $V_I$    | $t_r/t_f$    |            |                   |       |              |              |
| $1.8V \pm 0.15V$ | $V_{CC}$ | $\leq 2ns$   | $V_{CC}/2$ | $2 \times V_{CC}$ | 30pF  | 1K $\Omega$  | 0.15V        |
| $2.5V \pm 0.2V$  | $V_{CC}$ | $\leq 2ns$   | $V_{CC}/2$ | $2 \times V_{CC}$ | 30pF  | 500 $\Omega$ | 0.15V        |
| 2.7V             | 2.7V     | $\leq 2ns$   | 1.5V       | 6V                | 50pF  | 500 $\Omega$ | 0.3V         |
| $3.3V \pm 0.3V$  | 3V       | $\leq 2.5ns$ | 1.5V       | 6V                | 50pF  | 500 $\Omega$ | 0.3V         |
| $5V \pm 0.5V$    | $V_{CC}$ | $\leq 2.5ns$ | $V_{CC}/2$ | $2 \times V_{CC}$ | 50pF  | 500 $\Omega$ | 0.3V         |

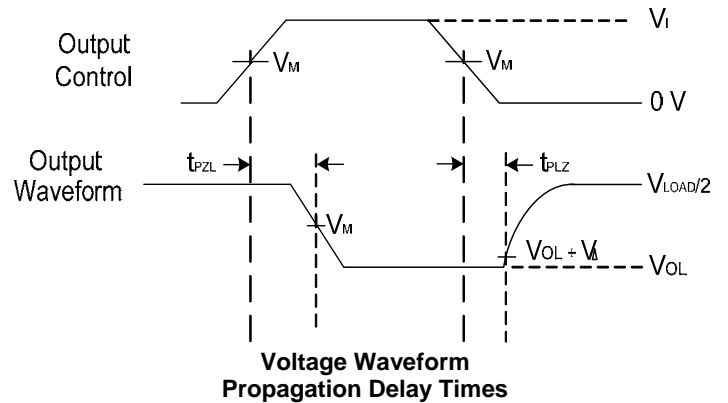
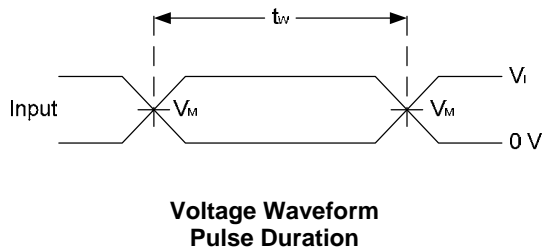

- Notes:
- A. Includes test lead and test apparatus capacitance.
  - B. All pulses are supplied at pulse repetition rate  $\leq 10$  MHz.
  - C. The inputs are measured one at a time with one transition per measurement.
  - D.  $t_{PZL}$  is measured at  $V_M$ .
  - E.  $t_{PLZ}$  is measured at  $V_{OL} + V_{\Delta}$ .

**Figure 1. Load Circuit and Voltage Waveforms**

**Ordering Information**

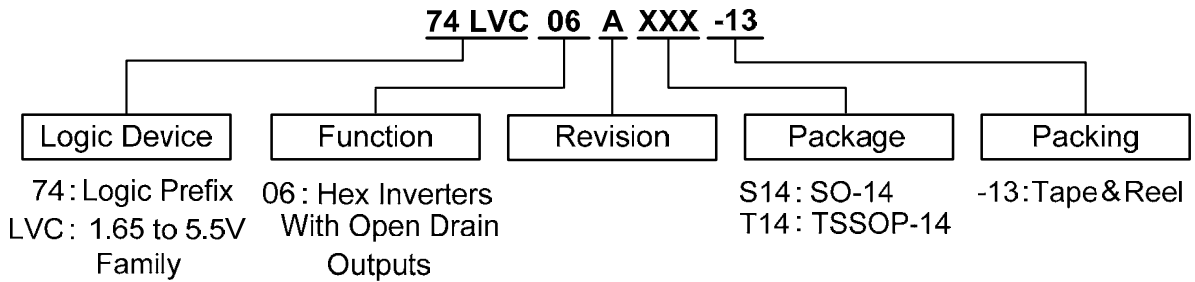

| Device         | Package Code | Packaging (Note 7) | 13" Tape and Reel |                    |
|----------------|--------------|--------------------|-------------------|--------------------|
|                |              |                    | Quantity          | Part Number Suffix |
| 74LVC06AS14-13 | S14          | SO-14              | 2500/Tape & Reel  | -13                |
| 74LVC06AT14-13 | T14          | TSSOP-14           | 2500/Tape & Reel  | -13                |

Notes: 7. The taping orientation and tape details can be found at <http://www.diodes.com/datasheets/ap02007.pdf>

**Marking Information**

(1) SO-14, TSSOP-14

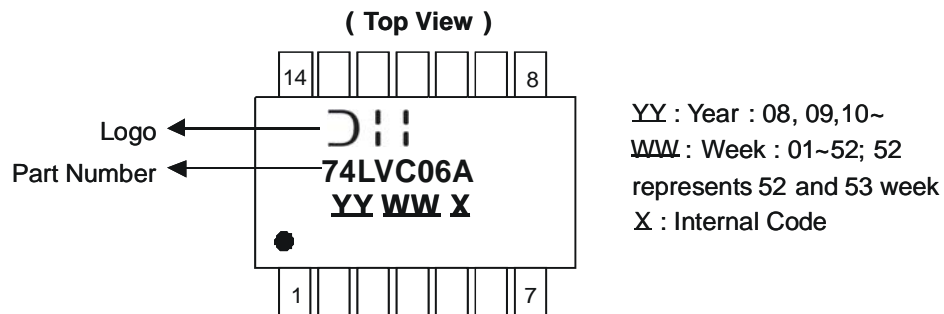

| Part Number | Package  |
|-------------|----------|
| 74LVC06AS14 | SO-14    |
| 74LVC06AT14 | TSSOP-14 |

**Package Outline Dimensions** (All dimensions in mm.)

**Package Type: SO-14**

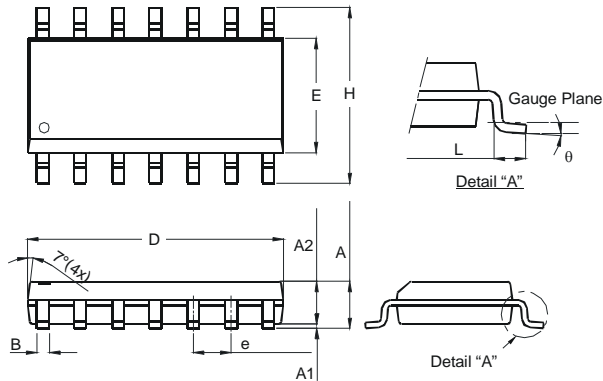

| SO-14                       |          |      |
|-----------------------------|----------|------|
| Dim                         | Min      | Max  |
| A                           | 1.47     | 1.73 |
| A1                          | 0.10     | 0.25 |
| A2                          | 1.45 Typ |      |
| B                           | 0.33     | 0.51 |
| D                           | 8.53     | 8.74 |
| E                           | 3.80     | 3.99 |
| e                           | 1.27 Typ |      |
| H                           | 5.80     | 6.20 |
| L                           | 0.38     | 1.27 |
| $\theta$                    | 0°       | 8°   |
| <b>All Dimensions in mm</b> |          |      |

**Package Type: TSSOP-14**

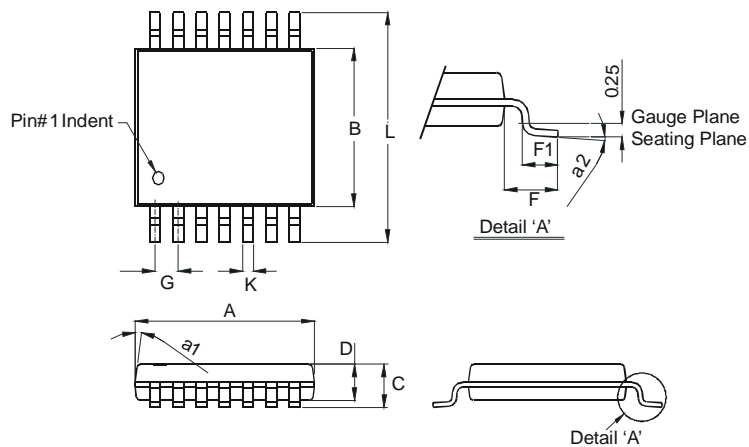

| TSSOP-14                    |          |      |
|-----------------------------|----------|------|
| Dim                         | Min      | Max  |
| a1                          | 7° (4X)  |      |
| a2                          | 0°       | 8°   |
| A                           | 4.9      | 5.10 |
| B                           | 4.30     | 4.50 |
| C                           | —        | 1.2  |
| D                           | 0.8      | 1.05 |
| F                           | 1.00 Typ |      |
| F1                          | 0.45     | 0.75 |
| G                           | 0.65 Typ |      |
| K                           | 0.19     | 0.30 |
| L                           | 6.40 Typ |      |
| <b>All Dimensions in mm</b> |          |      |

---

## Suggested Pad Layout

---

Package Type: SO-14

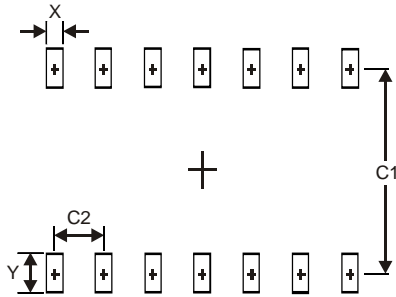

| Dimensions | Value (in mm) |
|------------|---------------|
| X          | 0.60          |
| Y          | 1.50          |
| C1         | 5.4           |
| C2         | 1.27          |

Package Type: TSSOP-14

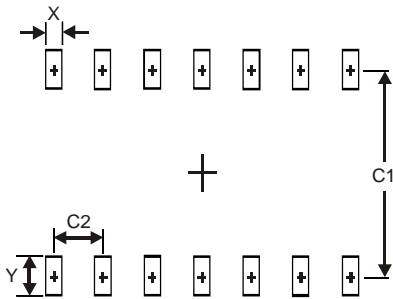

| Dimensions | Value (in mm) |
|------------|---------------|
| X          | 0.45          |
| Y          | 1.45          |
| C1         | 5.9           |
| C2         | 0.65          |

**IMPORTANT NOTICE**

DIODES INCORPORATED MAKES NO WARRANTY OF ANY KIND, EXPRESS OR IMPLIED, WITH REGARDS TO THIS DOCUMENT, INCLUDING, BUT NOT LIMITED TO, THE IMPLIED WARRANTIES OF MERCHANTABILITY AND FITNESS FOR A PARTICULAR PURPOSE (AND THEIR EQUIVALENTS UNDER THE LAWS OF ANY JURISDICTION).

Diodes Incorporated and its subsidiaries reserve the right to make modifications, enhancements, improvements, corrections or other changes without further notice to this document and any product described herein. Diodes Incorporated does not assume any liability arising out of the application or use of this document or any product described herein; neither does Diodes Incorporated convey any license under its patent or trademark rights, nor the rights of others. Any Customer or user of this document or products described herein in such applications shall assume all risks of such use and will agree to hold Diodes Incorporated and all the companies whose products are represented on Diodes Incorporated website, harmless against all damages.

Diodes Incorporated does not warrant or accept any liability whatsoever in respect of any products purchased through unauthorized sales channel. Should Customers purchase or use Diodes Incorporated products for any unintended or unauthorized application, Customers shall indemnify and hold Diodes Incorporated and its representatives harmless against all claims, damages, expenses, and attorney fees arising out of, directly or indirectly, any claim of personal injury or death associated with such unintended or unauthorized application.

Products described herein may be covered by one or more United States, international or foreign patents pending. Product names and markings noted herein may also be covered by one or more United States, international or foreign trademarks.

**LIFE SUPPORT**

Diodes Incorporated products are specifically not authorized for use as critical components in life support devices or systems without the express written approval of the Chief Executive Officer of Diodes Incorporated. As used herein:

A. Life support devices or systems are devices or systems which:

1. are intended to implant into the body, or
2. support or sustain life and whose failure to perform when properly used in accordance with instructions for use provided in the labeling can be reasonably expected to result in significant injury to the user.

B. A critical component is any component in a life support device or system whose failure to perform can be reasonably expected to cause the failure of the life support device or to affect its safety or effectiveness.

Customers represent that they have all necessary expertise in the safety and regulatory ramifications of their life support devices or systems, and acknowledge and agree that they are solely responsible for all legal, regulatory and safety-related requirements concerning their products and any use of Diodes Incorporated products in such safety-critical, life support devices or systems, notwithstanding any devices- or systems-related information or support that may be provided by Diodes Incorporated. Further, Customers must fully indemnify Diodes Incorporated and its representatives against any damages arising out of the use of Diodes Incorporated products in such safety-critical, life support devices or systems.

Copyright © 2012, Diodes Incorporated

[www.diodes.com](http://www.diodes.com)

## Looking for pricing, stock, or lifecycle information?

Click below to explore more details on WIN SOURCE:

- ⊖ [View 74LVC06AT14-13 on WIN SOURCE](#)
- ⊖ [Diodes Incorporated Information](#)

## Optimize Your Supply Chain with WIN SOURCE Solutions

- ✓ Global Sourcing Solution
- ✓ Obsolete Management
- ✓ Cost Control Management
- ✓ Shortage Management
- ✓ Alternative Solution
- ✓ Excess Inventory Management