

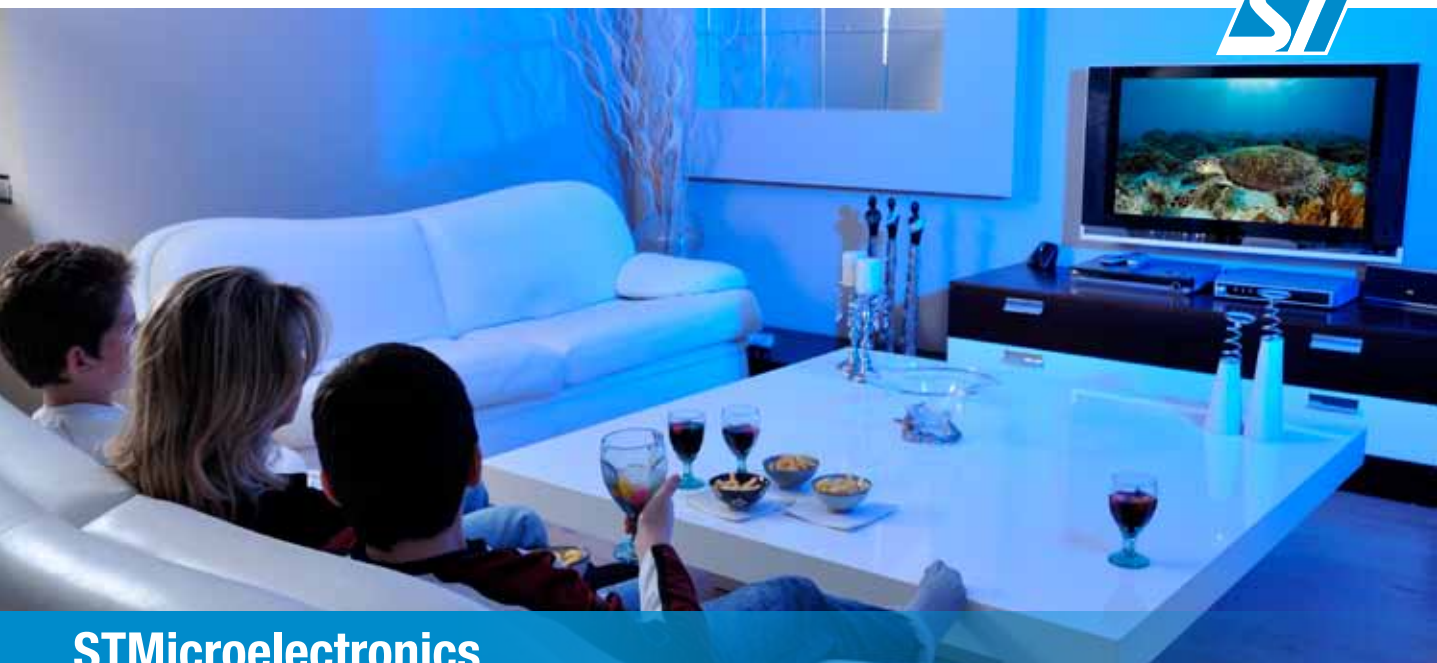

THE DATASHEET OF LNBH25SPQR



Peripheral semiconductors for set-top box applications



STMicroelectronics

Content

ST peripheral products overview for set-top boxes	4
Power management	4
Front panel displays	4
Separable security	4
LNB power supplies	5
Audio blocks	5
Smartcard readers	5
Remote controls	5
Data communication	5
Video blocks	5
Motion sensors (MEMS)	6
iNEMO - Inertial modules	6
Gyroscopes	6
Accelerometers	6
Digital compasses	6
Power management	7
Switching regulators	7
LNB supply ICs	7
Integrated EMI filtering and ESD protection	8
High-speed protection devices	8
Smartcard interfaces	8

ST peripheral products overview for set-top boxes

Power management

Power MOSFETs – low voltage (STripFET VI DeepGATE. N- and P-channel)

- From 20 to 60 V
- Reduced switching and conduction losses
- Trench technology for high efficiency
- New chip scale package (PowerFLAT 2x2)

Power MOSFETs – high voltage (SuperMESH3 / MDmesh II)

- From 500 to 700 V
- Suitable for AC-DC stage
- Low $R_{DS(on)}$ and switching losses for high efficiency

Microprocessor supervisors

STM6779, STM6905

- Up to 5 voltage resets
- Manual reset with delay manual reset

Linear regulators – very low dropout

LD1117, LD29080/150/300, LD39080/150/300, LD49150/300, ST1L0, LD39050, LD39100

- Very low dropout voltage from 0.2 V
- Output current: up to 5 A
- Logic-controlled electronic shutdown
- Output voltages: 0.8 to 12 V and down to 0.8 V

DC-DC conversion – step-down

ST1S¹

- Step-down current mode PWM (up to 1.5 MHz)
- 2.7 to 18 V input voltage range
- Synchronous rectification
- Internal soft-start and power-on delay
- Maximum output current up to 4 A

L598, L798

- Up to 3 A DC output current
- 2.9 to 18 V input voltage range (up to 28 V for L798)
- Output voltage adjustable from 0.6 V
- 250 kHz switching frequency, programmable up to 1 MHz
- Overcurrent, overvoltage and thermal protection

AC-DC conversion – high-voltage converters

VIPer25, VIPer28, VIPer37

- High efficiency
- Standby PSU consumption less than 30 mW
- 800 V avalanche rugged power section
- PWM operation with fixed frequency jittering for low EMI
- Thermal shutdown with hysteresis
- Quasi-resonant control (VIPer25)

Schottky diodes for secondary rectification

STPS

- 20 to 100 V reverse voltage
- SMD packages below 5 A
- Power packages above 5 A
- Low V_f

Clamping arrays

STRVS

- Transil™ RVS (repetitive voltage suppressor)
- MOSFET protection and snubber replacement
- Constant clamping voltage whatever load condition
- Provides electrical parameters at high temperature (V_{CL} , R_D , V_{BR})

Front panel displays

Integrated EMI filtering and ESD protection

EMIF*-1005

- Available in 4/6/8-line configuration
- Micro qFN package
- IEC 61000-4-2 level 4, 15 kV

VFD controllers

- Compact single-chip solution
- Easy software implementation through SPI/I²C serial interface
- Drives VFD panels with 8 digits, 20 segments up to 16 digits, 12 segments
- Energy Star and Blue Angel standard compliant
- Integrated key-scan, infrared RC decoder and real-time clock (RTC)

LED controllers

STLED316, STLED325

- Drives up to 7 digits, 8 segments
- Drive capability of 40 mA (max)
- Integrated key-scan up to 16 keys
- 3-wire serial SPI interface
- Low power consumption during standby

Microcontrollers

STM8L

- Ultra-low-power 8-bit MCU
- 4- to 64-Kbyte Flash, 20 to 80 pins
- 12-bit ADC (1 μ s), 12-bit DAC
- PWM timers, watchdogs
- Drives 8 x 40 LCD
- Keys and touch sensing

STM8S10

- 4- to 32-Kbyte Flash memory
- 10-bit ADC
- PWM timers
- Drives 4-digit, 7-segment LED displays
- Mechanical and touch sensing keys
- Support of any IR protocol
- CEC control

Separable security

Power switches

ST890

- Input range: 2.7 to 5.5 V
- Programmable current limit: up to 1.2 A by external resistance
- Low quiescent current
- Thermal shutdown, fault indicator output

STMPS2141, STMPS2151, STMPS2161, STMPS2171, STMPS2242, STMPS2252, STMPS2262, STMPS2272

- Enhanced single or dual power switches
- Input range: 2.7 to 5.5 V
- 500 mA/1 A continuous current with fixed current limit
- Low quiescent current
- Thermal shutdown, fault indicator output, reverse-current protection and fault-blanking features

Hot-swap power management – e-fuses

STEF05, STEF12

- 5 V and 12 V rails
- Programmable current limit
- Programmable soft-start
- Overvoltage clamp
- Fault indicator



Serial real-time clocks

M41T62

- World's smallest embedded crystal RTC
- Serial RTC with alarm
- 32 kHz output
- Power supply from 1.3 to 4.4 V
- Timekeeping down to 1.0 V
- Current consumption: 350 nA at 3 V

Temperature sensors

STTS75, STTS751

- Digital I²C temperature sensor
- ± 1.0 °C (typ) accuracy from 0 °C to +85 °C
- Power saving one-shot temperature measurement
- Power supply range: 2.25 to 5.5 V

STLM20

- Precision analog voltage output temperature sensor
- Operating voltage: 2.4 to 5.5 V
- Ultra-low quiescent supply current: 8.0 μ A max

Note:

1. Details in following pages

* is used as a wildcard character for related part numbers

LNB power supplies

LNB supply ICs

LNBH2¹, LNBH3

- Built-in DC-DC converters for single 12 V supplies with integrated NMOS
- Built-in 22 kHz tone detector supports bidirectional DiSEqCTM 2.0, DiSEqC 1.0 (L version) receivers/sat-TV, sat-PC cards
- LNB short-circuit dynamic protection and diagnostics
- Dual tuner application (LNBH24/24L, LNBH26/26L)

Protection devices

LNBTVS

- Up to 500 A peak protection (1.2/50 μ s; 8/20 μ s combination waveform)
- Unidirectional protection
- 2 voltages according to LNB choice

Audio blocks

EMIF02-SPK02F2

- Low serial impedance
- High rejection of the 900 MHz to 3 GHz band
- Ultra-small CSP package

LM833

- Low-noise dual operational amplifier
- Wide power supply range: +/- 2.5 V to +/- 15 V
- 15 MHz bandwidth
- Low distortion and low noise

LMV358L

- Low-power rail-to-rail amplifier
- Low supply voltage: 2.7 to 5.5 V
- Low current consumption: 130 μ A

TSH62

- Low-cost rail-to-rail wide band amplifier
- Wide power supply range: 5 to 12 V
- 60 MHz bandwidth
- Excellent PSRR leading to better audio performances

TS4657

- Stereo digital audio line driver with capless outputs
- Single supply voltage: 3.0 to 5.5 V
- Output voltage: 2.2 V_{rms} max
- Digital audio inputs: I²S, left-justified, right-justified
- 16-bit to 24-bit data format, 32 kHz to 48 kHz

Smartcard readers

Smartcard interface (ASI)

ST8024, ST8024L¹

- ISO 7816-3 compatible with the NDS conditional access system (ST8024 in progress)
- 3 specific, protected half-duplex bidirectional buffered I/O lines
- Compatible with class A, B and C smartcards

Microcontrollers

STM32F, STM32L

- 32-bit Cortex-M family
- 24 to 150 MHz
- 16-Kbyte to 1-Mbyte Flash
- Full set of communication peripherals: U(S)ART, SPI, I²C, USB device/host, Ethernet, SDIO
- HDMI consumer electronic control (CEC)

Remote controls

LDO linear regulators

LDCL015, LD39115J, STLQ015, LD59015

- 150 mA maximum current
- Ultra low dropout (<= 100 mV)
- Tiny packages: SC70, SOT666 and SOT23

Microcontrollers

STM32W

- 32-bit ARM Cortex-M3 with 2.4 GHz radio embedded
- 64- to 256-Kbyte Flash memory
- ZigBee[®] RF4CE certified protocol stack with ZigBee[®] remote control application profile

Baluns

BAL-NRF01F3

- 50 Ω nominal input
- RF BOM and area reduction

BAL-32W108-01E3²

- 50 Ω nominal input
- Integrated 2.4 GHz band pass filter
- High rejection level of 2nd and 3rd order harmonics
- Compliant with ETSI/FCC regulations

Data communication

RS-232 interface ICs

ST2[®]E, ST3[®]E

- \pm 15 kV human body model (E series)
- \pm 8 kV contact discharge and \pm 15 kV air-gap discharge, IEC 1000-4-2 (E series)
- Data rate: 120 to 480 Kbit/s
- Slew rate range: 3 to 30 V/ μ s

Protection devices

USBLC6

- IEC 61000-4-2
- C = 0.42 pF

LCP

- ITU-T K20/21 and GR-1089
- Up to 175 V, 500 A, 2/10 μ s

HSP061

- 2-, 4- and 8-line ESD protection for high-speed lines
- Ultra-large bandwidth (6 GHz)
- Ultra-low capacitance (0.6 pF)
- High integration
- High ESD protection level

Video blocks

Video drivers

TSH345/TSH346

- High-definition video
- Single 5 V supply
- Integrated 6 dB gain
- Integrated 6th order video reconstruction filters for SD/PV/HD (TSH345) or HD only (TSH346)
- Multiplexed inputs (TSH345)

TSH343/TSH344

- High-definition video
- Single 5 V supply
- >250 MHz bandwidth
- Slew rate > 750 V/ μ s
- 0.1 dB gain flatness: 65 MHz
- Internal 6 dB gain
- Integrated DC shift (TSH343)

Integrated EMI filtering and ESD protection

HDMI2C1-14HD

- HDMI 1.4 compliant
- HEAC compliant
- ESD protection (8 kV contact IEC 61000-4-2)
- Long-/poor-quality-cable drive
- TMDS ESD protection up to 340 MHz
- Wake-up via CEC
- Optimized power consumption in standby mode

High-speed port protection

HSP061

- 2-, 4- and 8-line ESD protection for high-speed lines
- Ultra-large bandwidth (6 GHz)
- Ultra-low capacitance (0.6 pF)
- High integration
- High ESD protection level

HDMIULC6

- 15 kV (IEC 61000-4-2) ESD protection
- Ultra-large bandwidth (5.3 GHz)
- Low clamping voltage
- No impact on signal integrity

Touch-sensing capacitive sensors

STM8T142

- Multi-channels (from 1 to 300 matrix channels)
- Implementation of touchkeys, sliders and trackpad
- Long range proximity detection (25 cm)
- 10 μ A range active low-power mode

STMT07

- FingerTip multi-touch capacitive touchscreen controller
- Supports up to 10" screen on-cell and in-cell
- 20 mW for 10" screen active scanning
- <1 mm accuracy, >80 Hz scan rate
- Unprecedented charger noise immunity

Motion sensors (MEMS)¹

iNEMO - Inertial modules

- LSM330DLC, LSM330D

Gyroscopes

- L3GD20

Accelerometers

- LIS3DH, LIS3DSH, LIS2DH

Digital compasses

- LSM303DLHC, LSM303D

Note: 2. Available in Q1-13

Motion sensors (MEMS)

Wide range of sensors enabling enhanced capabilities for smart remote control

iNEMO - Inertial modules

LSM330DLC, LSM330D

The LSM330DLC and LSM330D are digital modules combining a 3D accelerometer and 3D gyroscope for smart remote control enabling gesture recognition, pointing, gaming and smart power management.

Key features

- User-selectable acceleration and gyroscope full scales
- 16-bit data output
- Low-power and power-down modes
- Independent embedded FIFO
- Independent programmable interrupts



Gyroscopes

L3GD20

The L3GD20 is a 3D digital gyroscope for gaming, pointing and motion control that gives applications greater accuracy and high reliability.

Key features

- Three selectable full scales (250/500/2000 dps)
- 16-bit data output
- Power-down and sleep modes
- Embedded FIFO
- Integrated low- and high-pass filters
- Ultra-stable over temperature and time



Accelerometers

LIS3DH, LIS3DSH, LIS2DH

The LIS3DH, LIS3DSH and LIS2DH are 3D digital accelerometers for smart power management, motion and orientation/direction detection.

Key features

- $\pm 2g/\pm 4g/\pm 8g/\pm 16g$ dynamically selectable full scale
- High resolution: up to 14 bits
- Ultra-low-power mode consumption down to 1 μA
- Embedded FIFO
- Independent programmable interrupts
- Embedded free-fall and motion detection



Digital compasses

LSM303DLHC, LSM303D

The LSM303DLHC and LSM303D are digital 3D accelerometer and 3D magnetometer modules for high-end remote control providing linear acceleration detection and heading for gaming and gesture recognition

Key features

- User-selectable acceleration and magnetic full scales
- 16-bit data output
- Low-power and power-down modes
- 6D/4D orientation detection
- High resolution and high sensitivity for both accelerometer and magnetometer
- Independent programmable interrupts



Power management

Set-top-box-IC and low-noise-block supplies

Switching regulators

ST1S40

The ST1S40 is an internally compensated 850 kHz fixed-frequency PWM synchronous step-down regulator. The ST1S40 operates with an input from 4.0 to 18 V and regulates an output voltage as low as 0.8 V and up to V_{IN} to supply your STB ICs. The peak-current mode control with internal compensation delivers a very compact solution with a minimum component count.

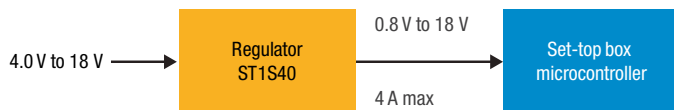

Key features

- 4 A peak output current
- Internal soft start
- Integrated 95 mΩ and 69 mΩ power MOSFETs
- Enable pin
- All ceramic capacitors
- Cycle-by-cycle current limiting
- Current foldback short-circuit protection

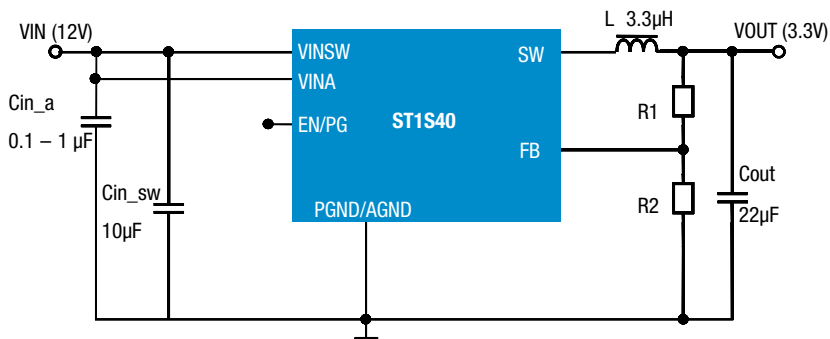

LNB supply ICs

LNBH25/25L, LNBH26/26L, LNBH29

Intended for analog and digital satellite receivers, satellite TV, satellite PC cards, these devices are monolithic voltage regulator and interface ICs. They are specifically designed to provide the 13/18 V power supply and the 22 kHz tone signaling to the LNB downconverter in antenna dishes or to the multi-switch box.



Key features

- Complete interface between LNB and I²C bus
- 15 output voltage levels
- Output surge robustness up to 40 V
- P2P compatibility between single and dual tuner versions
- Stable with ceramic and electrolytic capacitors
- Built-in high-efficiency 12 V DC-DC converter
- Selectable output current limit by external resistor
- Compliant with main satellite-receiver output-voltage specifications
- Accurate built-in 22 kHz tone generator suits widely accepted standards
- Internal overload and over-temperature protection

Integrated EMI filtering and ESD protection

HDMI2C

The HDMI2C series integrates ESD protection and signal conditioning for HDMI 1.4 transmitter and emitter interfaces.

Key features

- CEC, DDC, HEAC, 5 V and HPD
8 kV contact ESD protection
- Integrated I²C bidirectional reshaping and level shifter
- Supports direct connection to low-voltage HDMI ASICs
- Short-circuit and over-temperature protection on 5 V output
- Long or poor-quality HDMI cable drive support
- Optimized power consumption in standby mode and wake-up via CEC

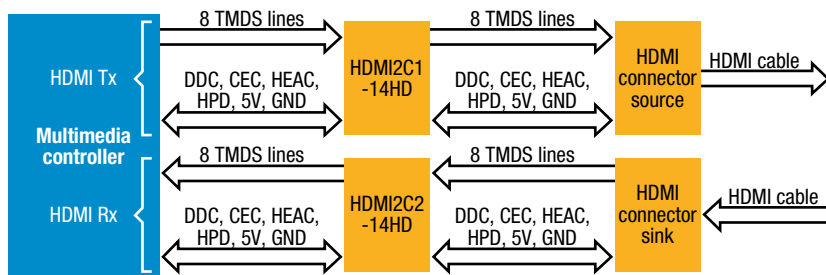

High-speed protection devices

HSP061

Monolithic, application-specific discrete devices dedicated to ESD protection of high-speed line connections.

Key features

- 2-, 4- and 8-line ESD protection for high-speed lines
- Ultra-large bandwidth: up to 7 GHz
- Ultra-low capacitance: down to 0.6 pF
- Low leakage current: down to 100 nA
- High ESD robustness for HDMI, DVI, USB, serial ATA, Ethernet, and other connections



Smartcard interfaces

ST8024L

The ST8024L is a complete low-cost analog interface for asynchronous Class A, B and C smartcards. It can be placed between the card and the set-top box microcontroller with only a few external components to perform all supply protection and control functions.

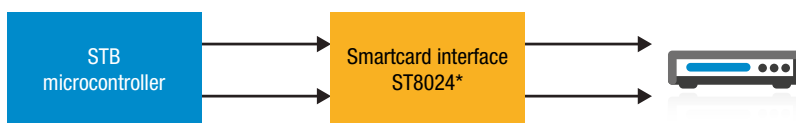

Key features

- Designed to be compatible with the NDS conditional access system
- 1.8 V, 3 V or 5 V supply for the IC
- Step-up converter to supply the card
- 26 MHz integrated crystal oscillator
- Clock generation for cards up to 20 MHz with synchronous frequency changes
- Enhanced ESD protection on card side (> 6 kV)
- ISO 7816, GSM11.11 and EMV 4.0 (payment systems) compatibility





Looking for pricing, stock, or lifecycle information?

Click below to explore more details on WIN SOURCE:

-  [View LNBH25SPQR on WIN SOURCE](#)
-  [STMicroelectronics Information](#)

Optimize Your Supply Chain with WIN SOURCE Solutions

-  Global Sourcing Solution
-  Obsolete Management
-  Cost Control Management
-  Shortage Management
-  Alternative Solution
-  Excess Inventory Management