



**THE DATASHEET OF
AD9631ARZ**



FEATURES

Wide bandwidth

AD9631, $G = +1$

AD9632, $G = +2$

Small signal

AD9631, 320 MHz

AD9632, 250 MHz

Large signal (4 V p-p)

AD9631, 175 MHz

AD9632, 180 MHz

Ultralow distortion (SFDR), low noise

–113 dBc typical @ 1 MHz

–95 dBc typical @ 5 MHz

–72 dBc typical @ 20 MHz

46 dBm third-order intercept @ 25 MHz

7.0 nV/√Hz spectral noise density

High speed

Slew rate: 1300 V/μs

Settling time to 0.01%, 2 V step: 16 ns

±3 V to ±5 V supply operation

17 mA supply current

APPLICATIONS

ADC input driver

Differential amplifiers

IF/RF amplifiers

Pulse amplifiers

Professional video

DAC current to voltage

Baseband and video communications

Pin diode receivers

Active filters/integrators/log amps

GENERAL DESCRIPTION

The **AD9631/AD9632** are very high speed and wide bandwidth amplifiers. The **AD9631** is unity gain stable. The **AD9632** is stable at gains of 2 or greater. Using a voltage feedback architecture, the exceptional settling time, bandwidth, and low distortion of the **AD9631/AD9632** meet the requirements of many applications that previously depended on current feedback amplifiers. Its classical op amp structure works much more predictably in many designs.

PIN CONFIGURATION

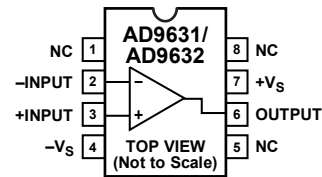

NOTES
1. NC = NO CONNECT.

Figure 1. 8-Lead PDIP (N) and SOIC (R) Packages

A proprietary design architecture has produced an amplifier that combines many of the best characteristics of both current feedback and voltage feedback amplifiers. The **AD9631/AD9632** exhibit exceptionally fast and accurate pulse response (16 ns to 0.01%) as well as extremely wide small signal and large signal bandwidth and ultralow distortion. The **AD9631** achieves –72 dBc at 20 MHz, 320 MHz small signal bandwidth, and 175 MHz large signal bandwidths.

These characteristics position the **AD9631/AD9632** ideally for driving flash as well as high resolution ADCs. Additionally, the balanced high impedance inputs of the voltage feedback architecture allow maximum flexibility when designing active filters.

The **AD9631/AD9632** are offered in the industrial (–40°C to +85°C) temperature range. They are available in PDIP and SOIC.

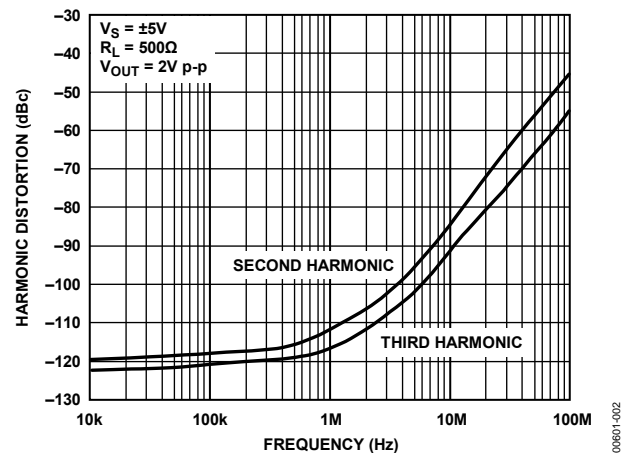

Figure 2. **AD9631** Harmonic Distortion vs. Frequency, $G = +1$

TABLE OF CONTENTS

Features	1	General.....	15
Applications.....	1	Feedback Resistor Choice.....	15
General Description	1	Pulse Response	16
Pin Configuration.....	1	Large Signal Performance	16
Revision History	2	Power Supply Bypassing	16
Specifications.....	3	Driving Capacitive Loads.....	16
Electrical Characteristics	3	Applications Information	17
Absolute Maximum Ratings.....	5	Operation as a Video Line Driver	17
Metallization Photo	5	Active Filters	17
Thermal Resistance	5	Analog-to-Digital Converter (ADC) Driver	18
Maximum Power Dissipation	5	Layout Considerations.....	18
ESD Caution.....	5	Outline Dimensions	19
Typical Performance Characteristics	6	Ordering Guide	20
Theory of Operation	15		

REVISION HISTORY

2/14—Rev. C to Rev. D

Changes to Figure 33.....	10
Changes to Analog-to-Digital Converter (ADC) Driver Section and Figure 66.....	18
Updated Outline Dimensions	19
Changes to Ordering Guide	20

7/03—Rev. B to Rev. C

Deleted Evaluation Boards information.....	Universal
Deleted military CERDIP version	Universal
Change to Absolute Maximum Ratings.....	3
Change to TPC 4.....	4
Change to TPC 10.....	5
Change to Figure 6	14
Updated Outline Dimensions	17

1/03—Rev. A to Rev. B

Deleted DIP (N) Inverter, SOIC (R) Inverter, and DIP (N) Noninverter Evaluation Boards in Figures 12–14.....	17
Updated Outline Dimensions	18

SPECIFICATIONS

ELECTRICAL CHARACTERISTICS

$\pm V_S = \pm 5\text{ V}$; $R_{LOAD} = 100\ \Omega$; $A_V = 1$ (AD9631); $A_V = 2$ (AD9632), unless otherwise noted.

Table 1.

Parameter	Test Conditions/Comments	AD9631			AD9632			Unit
		Min	Typ	Max	Min	Typ	Max	
DYNAMIC PERFORMANCE								
Bandwidth (–3 dB)								
Small Signal	$V_{OUT} \leq 0.4\text{ V p-p}$	220	320		180	250		MHz
Large Signal ¹	$V_{OUT} = 4\text{ V p-p}$	150	175		155	180		MHz
Bandwidth for 0.1 dB Flatness	$V_{OUT} = 300\text{ mV p-p}$ $R_F = 140\ \Omega$ (AD9631); $R_F = 425\ \Omega$ (AD9632)		130			130		MHz
Slew Rate, Average \pm	$V_{OUT} = 4\text{ V step}$	1000	1300		1200	1500		V/ μs
Rise/Fall Time	$V_{OUT} = 0.5\text{ V step}$		1.2			1.4		ns
	$V_{OUT} = 4\text{ V step}$		2.5			2.1		ns
Settling Time								
To 0.1%	$V_{OUT} = 2\text{ V step}$		11			11		ns
To 0.01%	$V_{OUT} = 2\text{ V step}$		16			16		ns
HARMONIC/NOISE PERFORMANCE								
Second Harmonic Distortion	2 V p-p; 20 MHz, $R_L = 100\ \Omega$		–64	–57		–54	–47	dBc
	$R_L = 500\ \Omega$		–72	–65		–72	–65	dBc
Third Harmonic Distortion	2 V p-p; 20 MHz, $R_L = 100\ \Omega$		–76	–69		–74	–67	dBc
	$R_L = 500\ \Omega$		–81	–74		–81	–74	dBc
Third-Order Intercept	25 MHz		46			41		dBm
Noise Figure	$R_S = 50\ \Omega$		18			14		dB
Input Voltage Noise	1 MHz to 200 MHz		7.0			4.3		nA/ $\sqrt{\text{Hz}}$
Input Current Noise	1 MHz to 200 MHz		2.5			2.0		pA/ $\sqrt{\text{Hz}}$
Average Equivalent Integrated Input Noise Voltage	0.1 MHz to 200 MHz		100			60		$\mu\text{V rms}$
Differential Gain Error (3.58 MHz)	$R_L = 150\ \Omega$		0.03	0.06		0.02	0.04	%
Differential Phase Error (3.58 MHz)	$R_L = 150\ \Omega$		0.02	0.04		0.02	0.04	Degree
Phase Nonlinearity	DC to 100 MHz		1.1			1.1		Degree
DC PERFORMANCE²								
Input Offset Voltage ³	$R_L = 150\ \Omega$		3	10		2	5	mV
	$T_{MIN} - T_{MAX}$			13			8	mV
Offset Voltage Drift			± 10			± 10		$\mu\text{V}/^\circ\text{C}$
Input Bias Current			2	7		2	7	μA
	$T_{MIN} - T_{MAX}$			10			10	μA
Input Offset Current			0.1	3		0.1	3	μA
	$T_{MIN} - T_{MAX}$			5			5	μA
Common-Mode Rejection Ratio	$V_{CM} = \pm 2.5\text{ V}$	70	90		70	90		dB
Open-Loop Gain	$V_{OUT} = \pm 2.5\text{ V}$	46	52		46	52		dB
	$T_{MIN} - T_{MAX}$	40			40			dB
INPUT CHARACTERISTICS								
Input Resistance			500			500		k Ω
Input Capacitance			1.2			1.2		pF
Input Common-Mode Voltage Range			± 3.4			± 3.4		V

Parameter	Test Conditions/Comments	AD9631			AD9632			Unit
		Min	Typ	Max	Min	Typ	Max	
OUTPUT CHARACTERISTICS								
Output Voltage Range	$R_L = 150 \Omega$	± 3.2	± 3.9		± 3.2	± 3.9		V
Output Current			70			70		mA
Output Resistance			0.3			0.3		Ω
Short Circuit Current			240			240		mA
POWER SUPPLY								
Operating Range		± 3.0	± 5.0	± 6.0	± 3.0	± 5.0	± 6.0	V
Quiescent Current			17	18		16	17	mA
	$T_{MIN} - T_{MAX}$			21			20	mA
Power Supply Rejection Ratio	$T_{MIN} - T_{MAX}$	50	60		56	66		dB

¹ See the Absolute Maximum Ratings and Theory of Operation sections of this data sheet.

² Measured at $A_V = 50$.

³ Measured with respect to the inverting input.

ABSOLUTE MAXIMUM RATINGS

Table 2.

Parameter	Rating
Supply Voltage (+V _S to -V _S)	12.6 V
Voltage Swing × Bandwidth Product	550 V × MHz
Internal Power Dissipation	
PDIP (N)	1.3 W
SOIC (R)	0.9 W
Input Voltage (Common Mode)	±V _S
Differential Input Voltage	±1.2 V
Output Short Circuit Duration	Observe Power Derating Curves
Storage Temperature Range	-65°C to +125°C
Operating Temperature Range (A Grade)	-40°C to +85°C
Lead Temperature Range (Soldering 10 sec)	300°C

Stresses above those listed under Absolute Maximum Ratings may cause permanent damage to the device. This is a stress rating only; functional operation of the device at these or any other conditions above those indicated in the operational section of this specification is not implied. Exposure to absolute maximum rating conditions for extended periods may affect device reliability.

METALLIZATION PHOTO

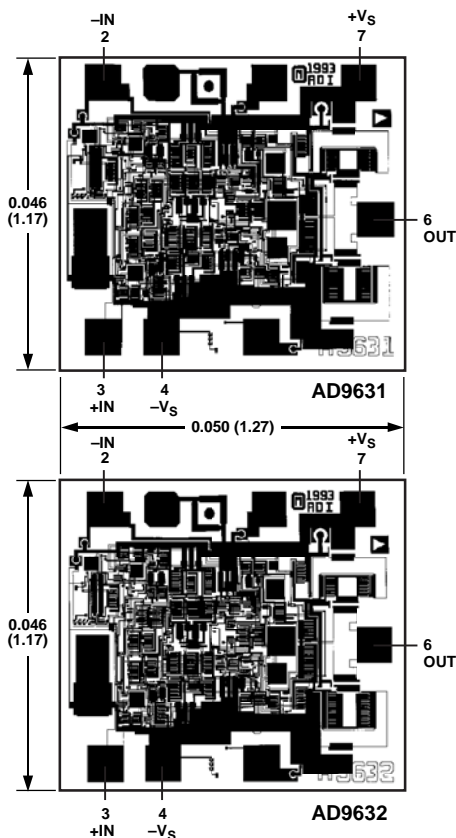

Figure 3. Dimensions shown in inches and (millimeters) Connect Substrate to -V_S

THERMAL RESISTANCE

Table 3.

Package Type ¹	θ _{JA}	Unit
8-Lead PDIP (N)	90	°C/W
8-Lead SOIC (R)	140	°C/W

¹ For device in free air.

MAXIMUM POWER DISSIPATION

The maximum power that can be safely dissipated by these devices is limited by the associated rise in junction temperature. The maximum safe junction temperature for plastic encapsulated devices is determined by the glass transition temperature of the plastic, approximately 150°C. Exceeding this limit temporarily may cause a shift in parametric performance due to a change in the stresses exerted on the die by the package. Exceeding a junction temperature of 175°C for an extended period can result in device failure.

While the AD9631 and AD9632 are internally short circuit protected, this may not be sufficient to guarantee that the maximum junction temperature (150°C) is not exceeded under all conditions. To ensure proper operation, it is necessary to observe the maximum power derating curves.

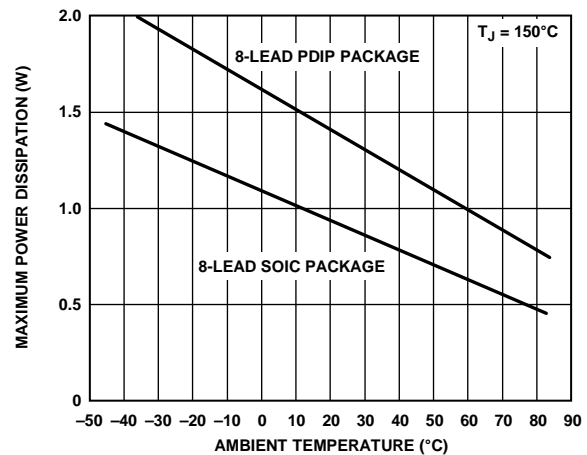

Figure 4. Maximum Power Dissipation vs. Temperature

ESD CAUTION



ESD (electrostatic discharge) sensitive device. Charged devices and circuit boards can discharge without detection. Although this product features patented or proprietary protection circuitry, damage may occur on devices subjected to high energy ESD. Therefore, proper ESD precautions should be taken to avoid performance degradation or loss of functionality.

TYPICAL PERFORMANCE CHARACTERISTICS

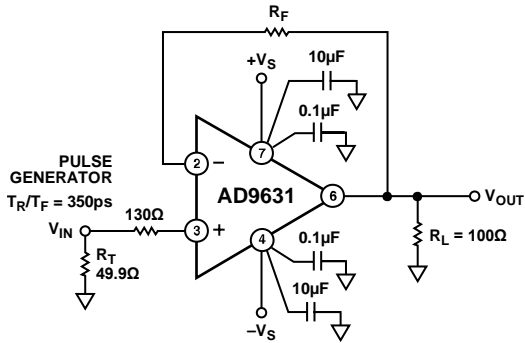

Figure 5. AD9631 Noninverting Configuration, $G = +1$

00601-005

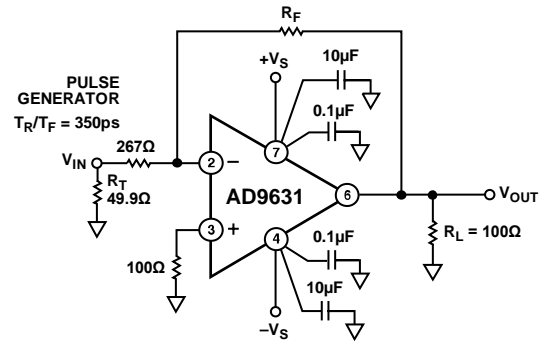

Figure 8. AD9631 Inverting Configuration, $G = -1$

00601-008

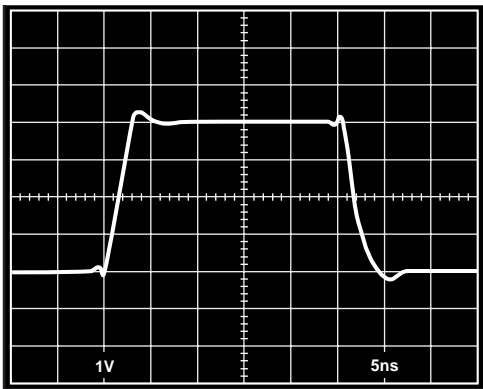

Figure 6. AD9631 Large Signal Transient Response; $V_{OUT} = 4\text{ V p-p}$, $G = +1$, $R_F = 250\ \Omega$

00601-006

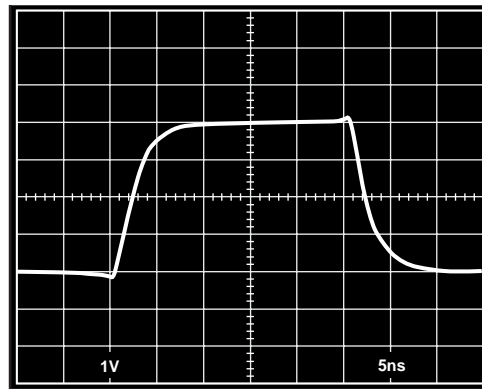

Figure 9. AD9631 Large Signal Transient Response; $V_{OUT} = 4\text{ V p-p}$, $G = -1$, $R_F = R_{IN} = 267\ \Omega$

00601-009

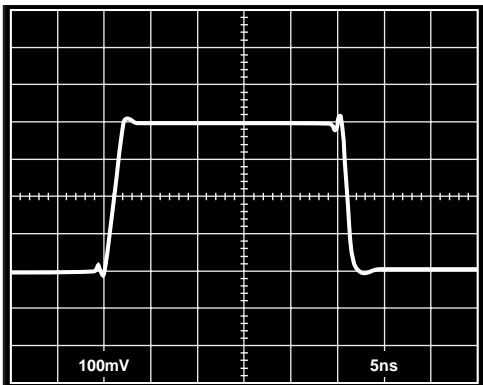

Figure 7. AD9631 Small Signal Transient Response; $V_{OUT} = 400\text{ mV p-p}$, $G = +1$, $R_F = 140\ \Omega$

00601-007

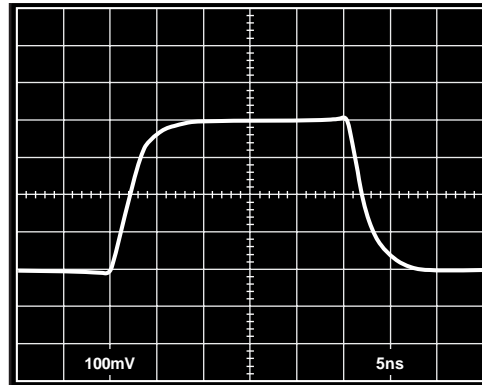

Figure 10. AD9631 Small Signal Transient Response; $V_{OUT} = 400\text{ mV p-p}$, $G = -1$, $R_F = R_{IN} = 267\ \Omega$

00601-010

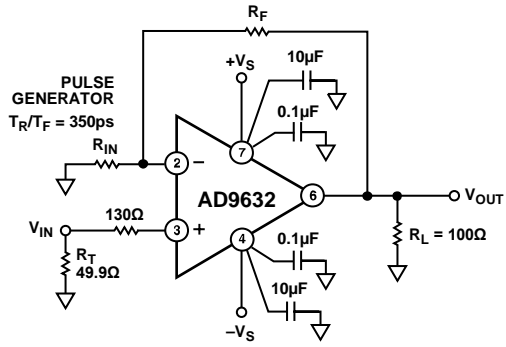

Figure 11. AD9632 Noninverting Configuration, $G = +2$

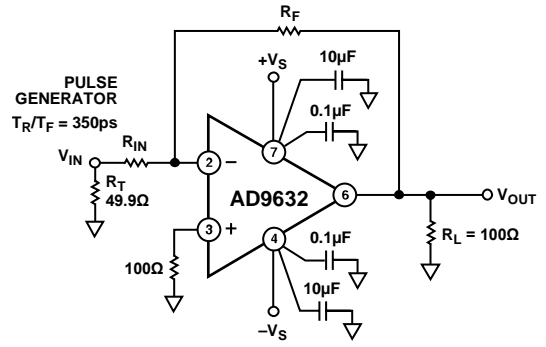

Figure 14. AD9632 Inverting Configuration, $G = -1$

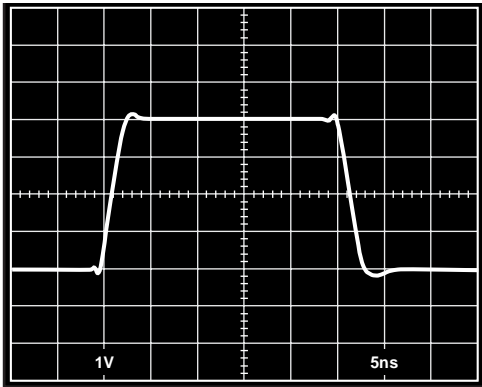

Figure 12. AD9632 Large Signal Transient Response; $V_{OUT} = 4\text{ V p-p}$, $G = +2$, $R_F = R_{IN} = 422\ \Omega$

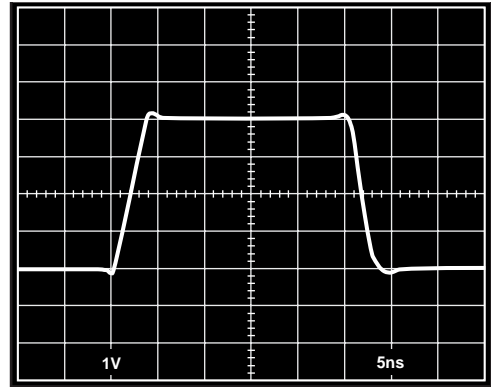

Figure 15. AD9632 Large Signal Transient Response; $V_{OUT} = 4\text{ V p-p}$, $G = -1$, $R_F = R_{IN} = 422\ \Omega$, $R_T = 56.2\ \Omega$

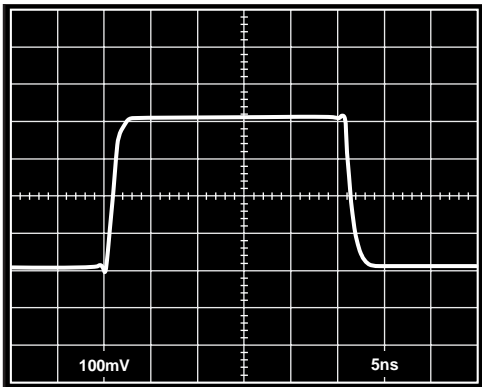

Figure 13. AD9632 Small Signal Transient Response; $V_{OUT} = 400\text{ mV p-p}$, $G = +2$, $R_F = R_{IN} = 274\ \Omega$

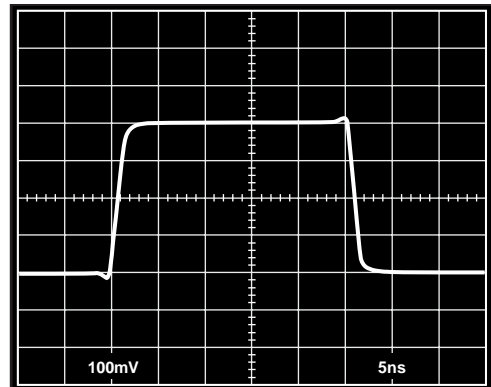

Figure 16. AD9632 Small Signal Transient Response; $V_{OUT} = 400\text{ mV p-p}$, $G = -1$, $R_F = R_{IN} = 267\ \Omega$, $R_T = 61.9\ \Omega$

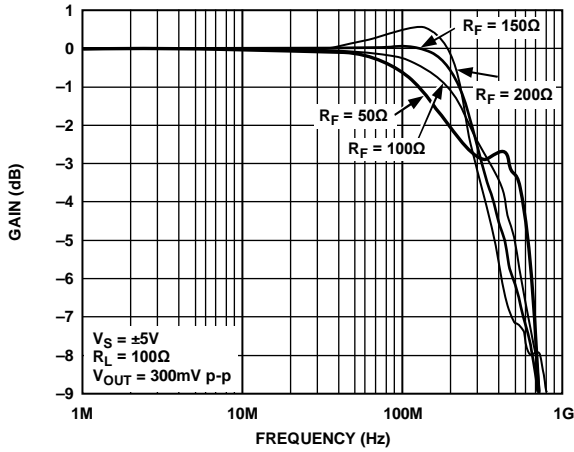

Figure 17. AD9631 Small Signal Frequency Response, $G = +1$

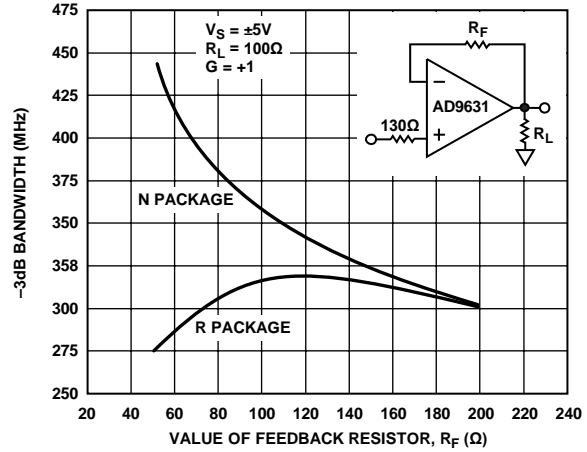

Figure 20. AD9631 Small Signal -3 dB Bandwidth vs. R_F

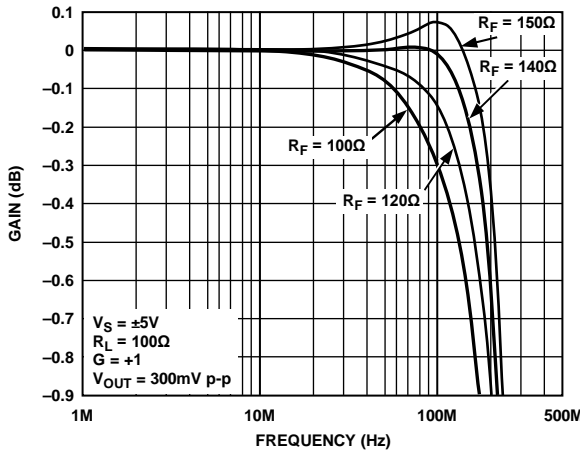

Figure 18. AD9631 0.1 dB Flatness, N Package (for R Package Add 20Ω to R_F)

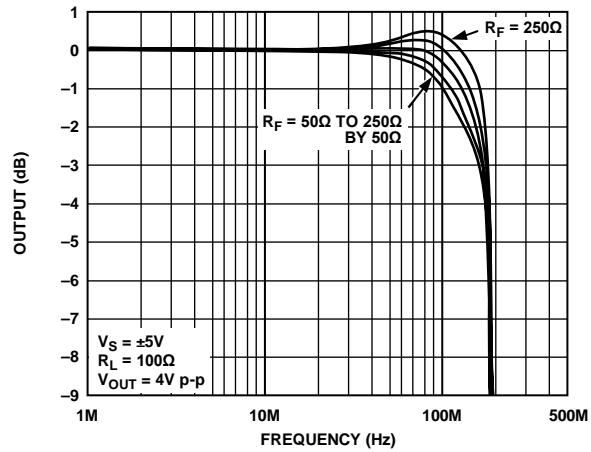

Figure 21. AD9631 Large Signal Frequency Response, $G = +1$

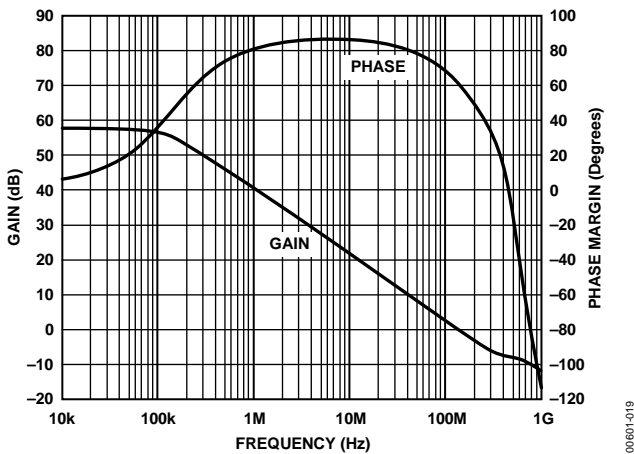

Figure 19. AD9631 Open-Loop Gain and Phase Margin vs. Frequency, $R_L = 100\Omega$

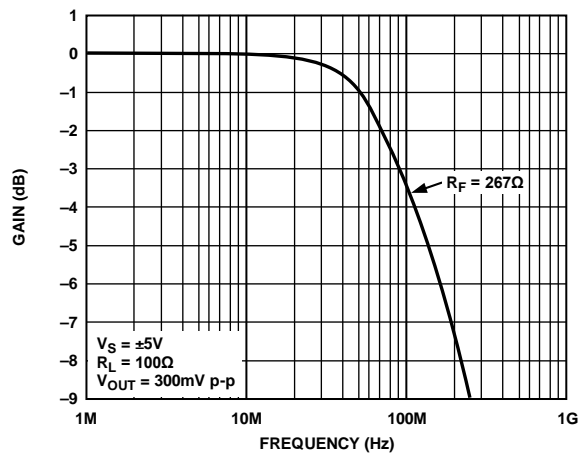

Figure 22. AD9631 Small Signal Frequency Response, $G = -1$

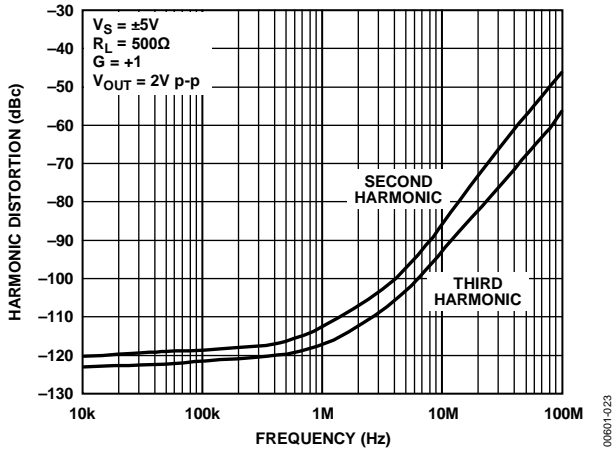

Figure 23. AD9631 Harmonic Distortion vs. Frequency, $R_L = 500\ \Omega$

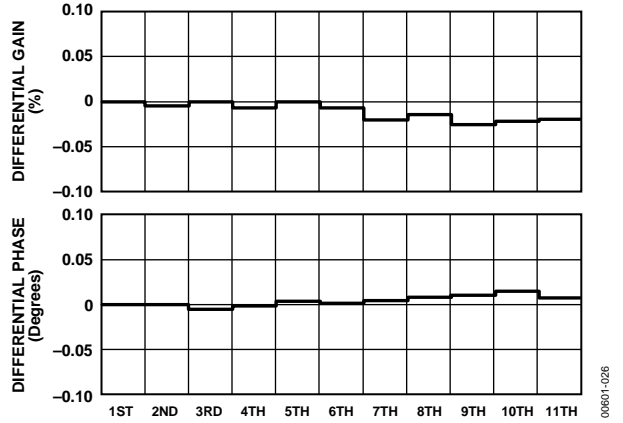

Figure 26. AD9631 Differential Gain and Phase Error, $G = +2$, $R_L = 150\ \Omega$

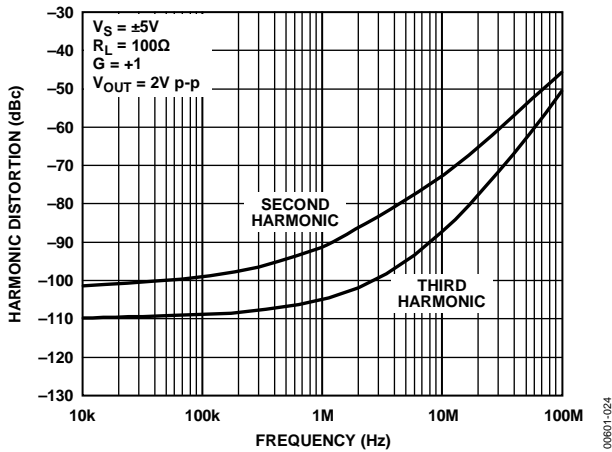

Figure 24. AD9631 Harmonic Distortion vs. Frequency, $R_L = 100\ \Omega$

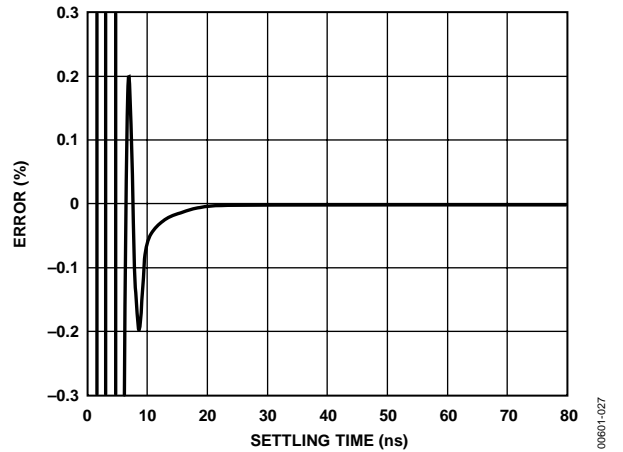

Figure 27. AD9631 Short-Term Settling Time, 2 V Step, $R_L = 100\ \Omega$

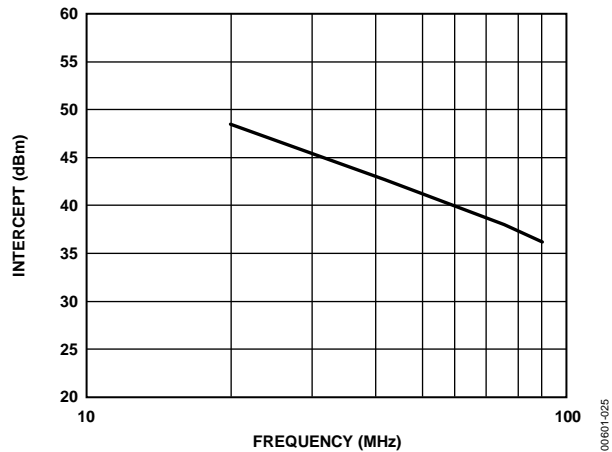

Figure 25. AD9631 Third Order Intercept vs. Frequency

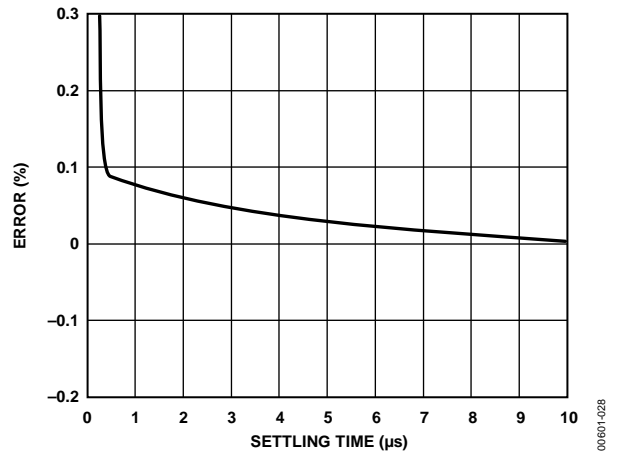

Figure 28. AD9631 Long-Term Settling Time, 2 V Step, $R_L = 100\ \Omega$

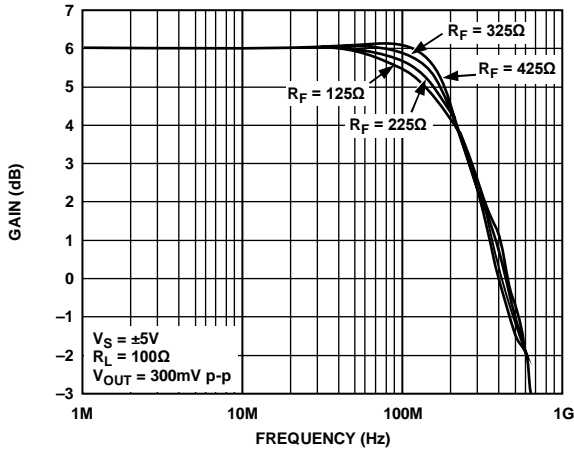

Figure 29. AD9632 Small Signal Frequency Response, $G = +2$

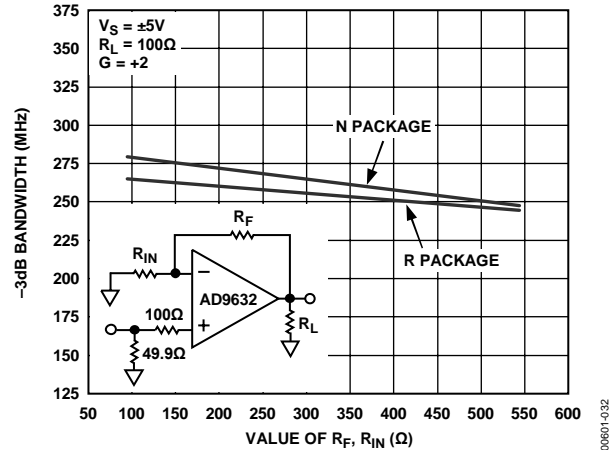

Figure 32. AD9632 Small Signal -3 dB Bandwidth vs. R_F, R_{IN}

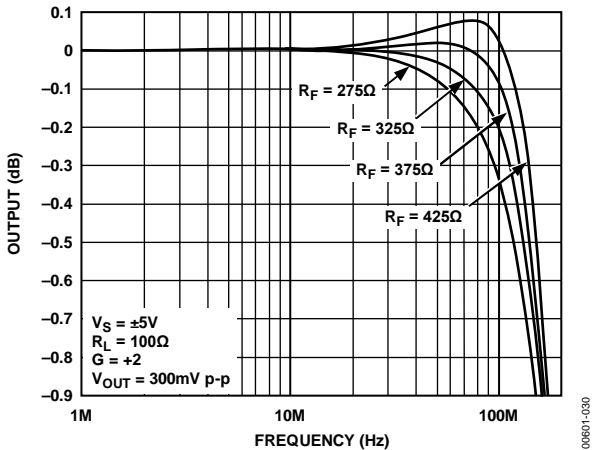

Figure 30. AD9632 0.1 dB Flatness, N Package (for R Package Add 20Ω to R_F)

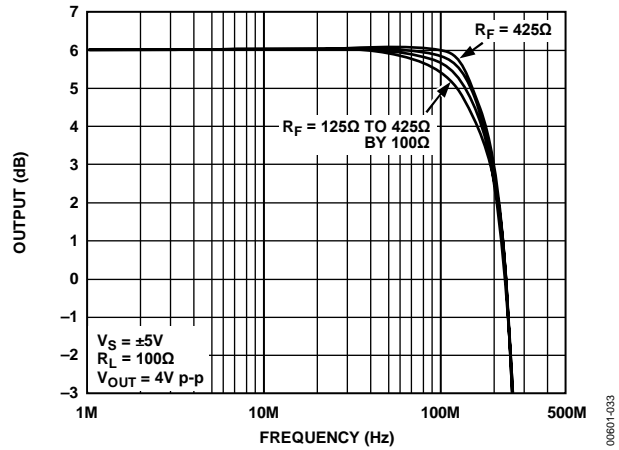

Figure 33. AD9632 Large Signal Frequency Response, $G = +2$

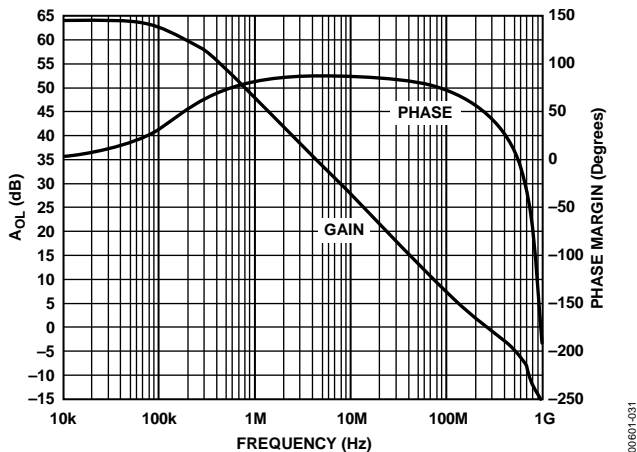

Figure 31. AD9632 Open-Loop Gain and Phase Margin vs. Frequency, $R_L = 100\Omega$

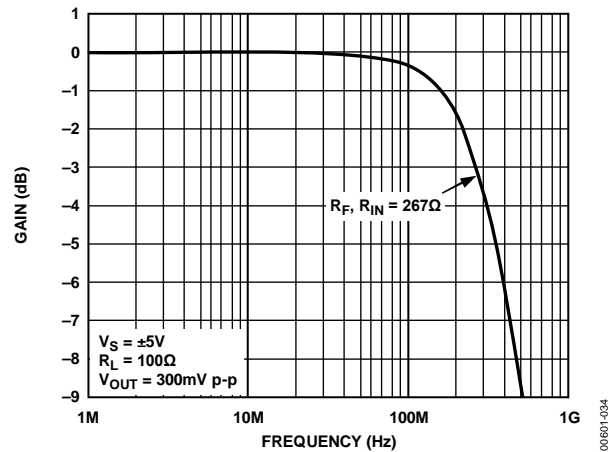

Figure 34. AD9632 Small Signal Frequency Response, $G = -1$

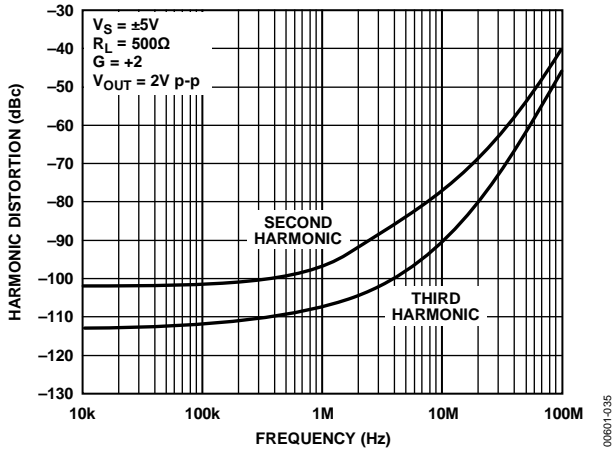

Figure 35. AD9632 Harmonic Distortion vs. Frequency, $R_L = 500 \Omega$

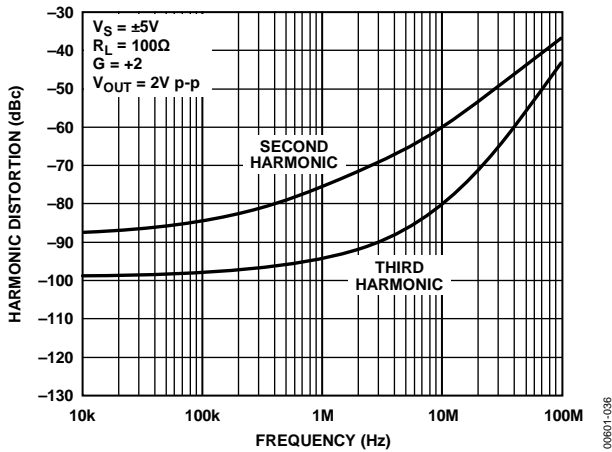

Figure 36. AD9632 Harmonic Distortion vs. Frequency, $R_L = 100 \Omega$

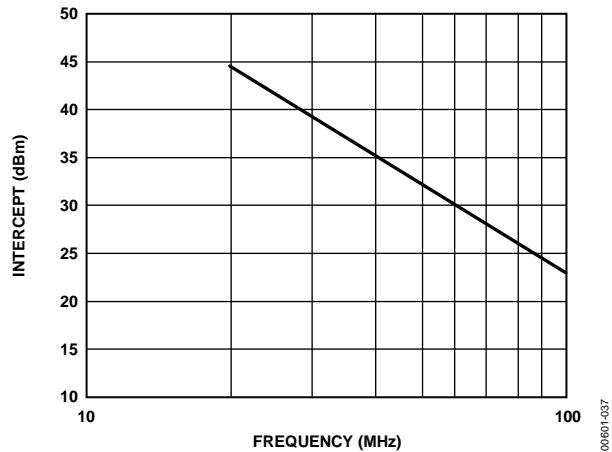

Figure 37. AD9632 Third Order Intercept vs. Frequency

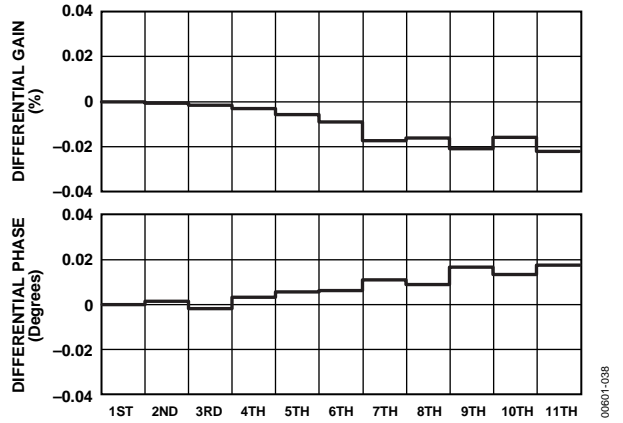

Figure 38. AD9632 Differential Gain and Phase Error $G = +2$, $R_L = 150 \Omega$

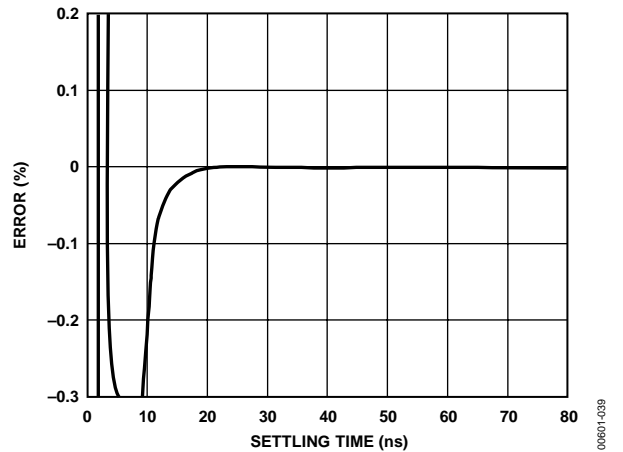

Figure 39. AD9632 Short-Term Settling Time, 2 V Step, $R_L = 100 \Omega$

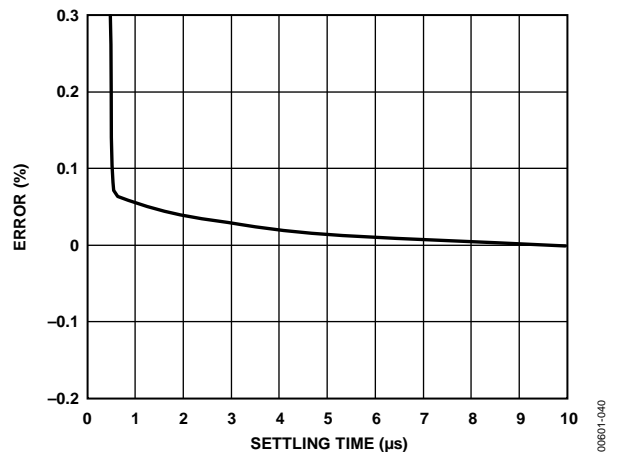

Figure 40. AD9632 Long-Term Settling Time, 2 V Step, $R_L = 100 \Omega$

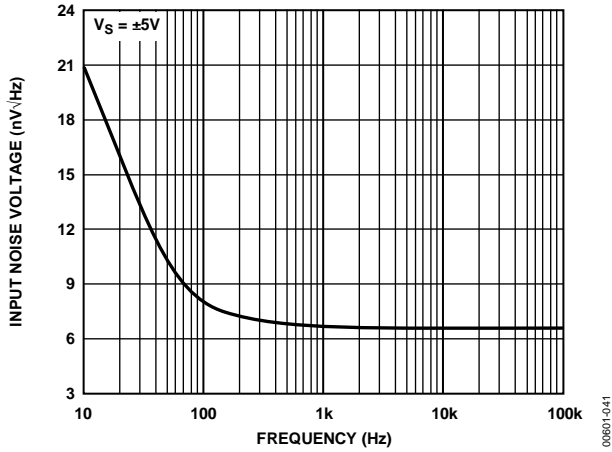

Figure 41. AD9631 Noise vs. Frequency

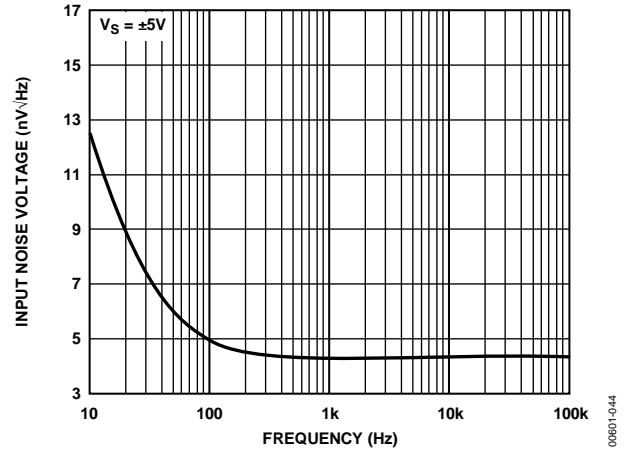

Figure 44. AD9632 Noise vs. Frequency

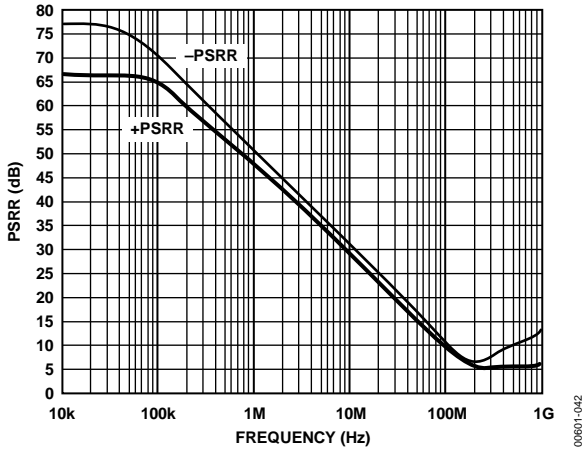

Figure 42. AD9631 PSRR vs. Frequency

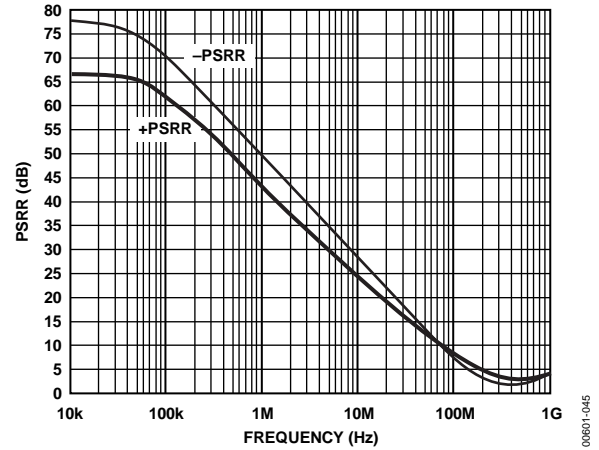

Figure 45. AD9632 PSRR vs. Frequency

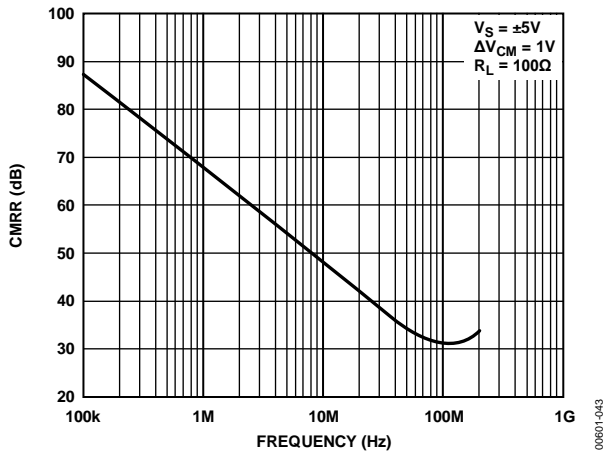

Figure 43. AD9631 CMRR vs. Frequency

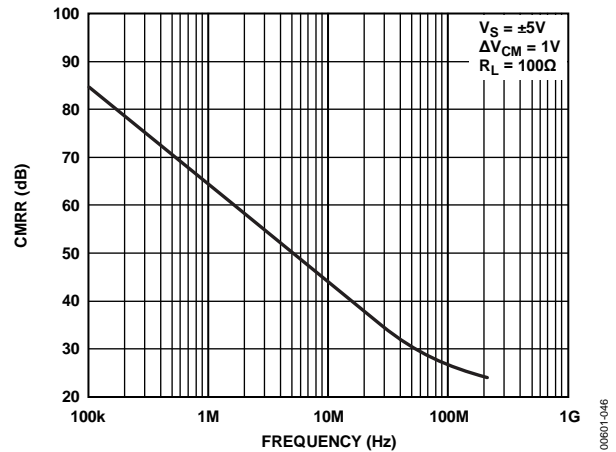

Figure 46. AD9632 CMRR vs. Frequency

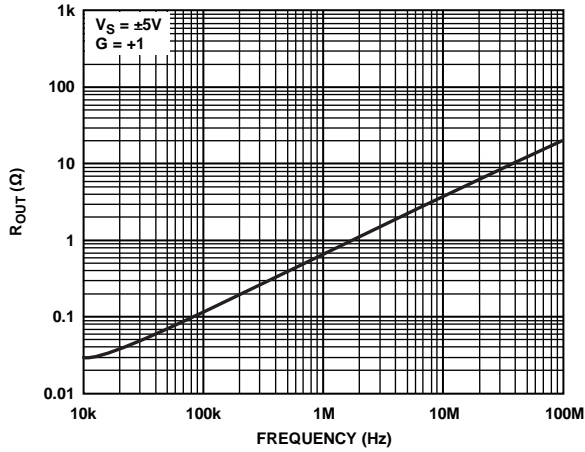

Figure 47. AD9631 Output Resistance vs. Frequency

00601-047

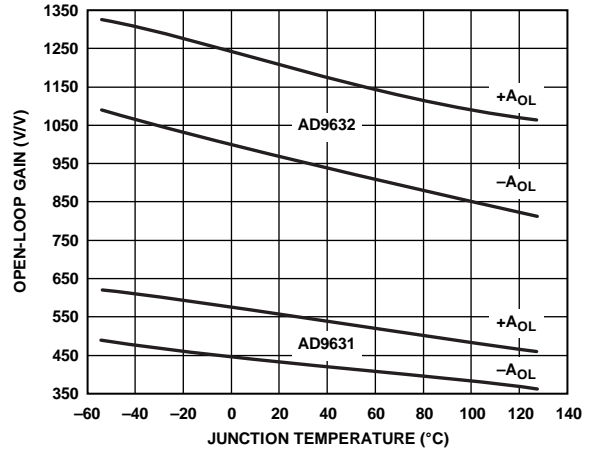

Figure 50. Open-Loop Gain vs. Temperature

00601-050

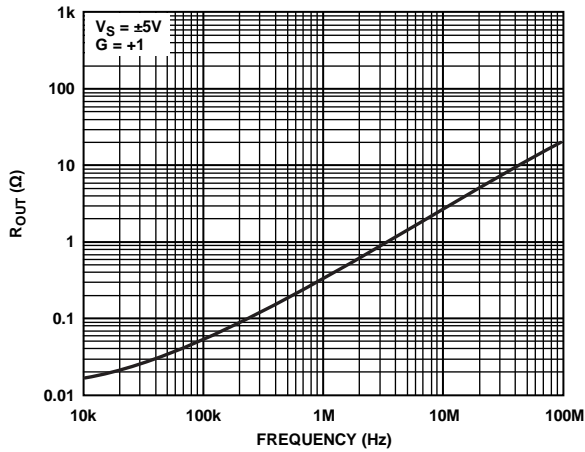

Figure 48. AD9632 Output Resistance vs. Frequency

00601-048

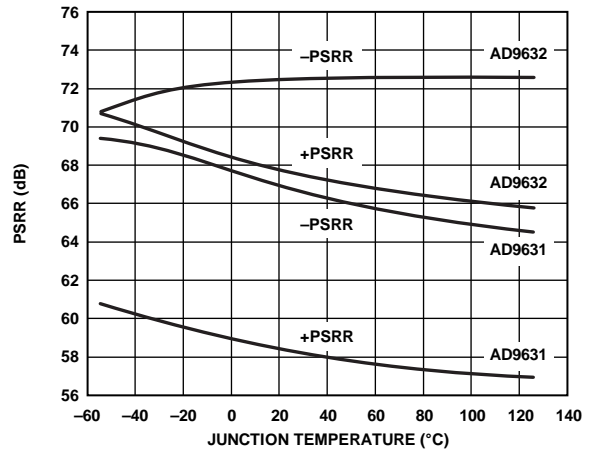

Figure 51. PSRR vs. Temperature

00601-051

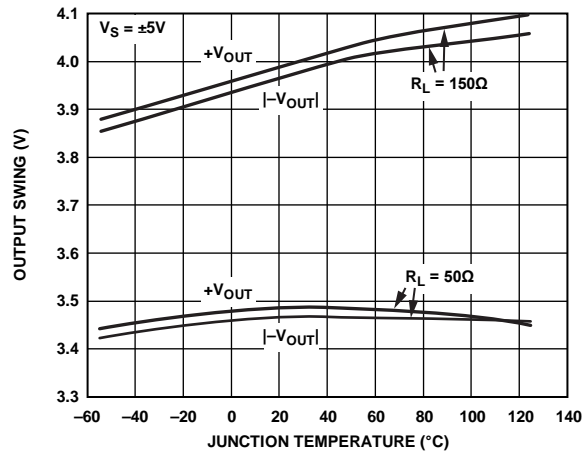

Figure 49. Output Swing vs. Temperature

00601-049

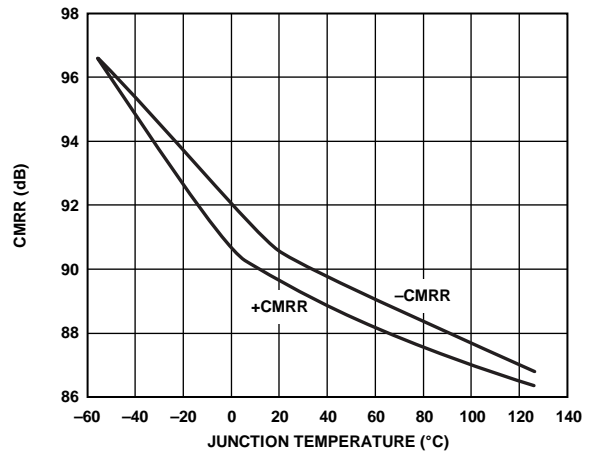

Figure 52. CMRR vs. Temperature

00601-052

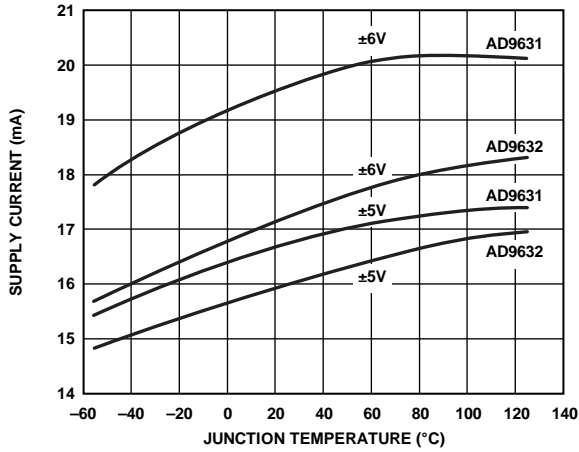

Figure 53. Supply Current vs. Temperature

09601-063

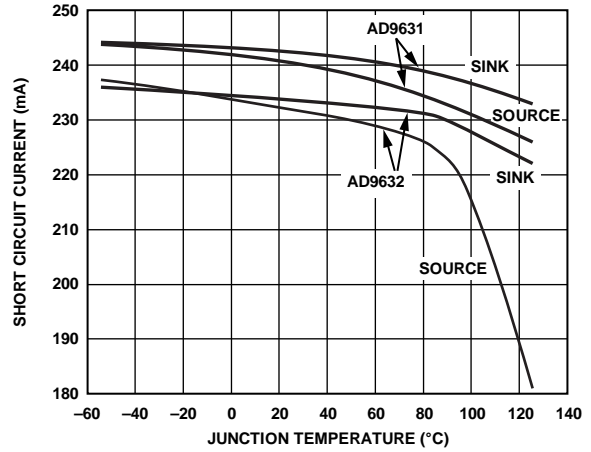

Figure 56. Short Circuit Current vs. Temperature

09601-066

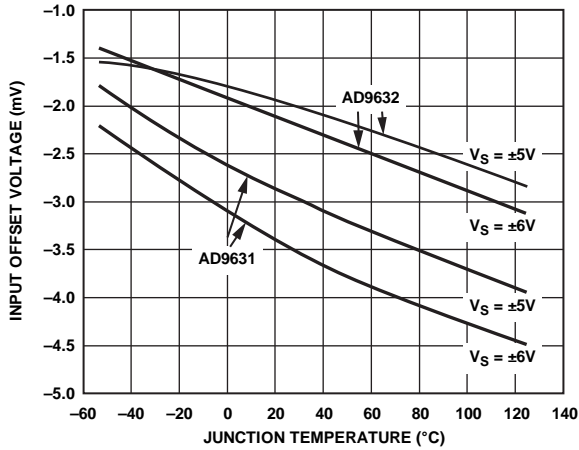

Figure 54. Input Offset Voltage vs. Temperature

09601-064

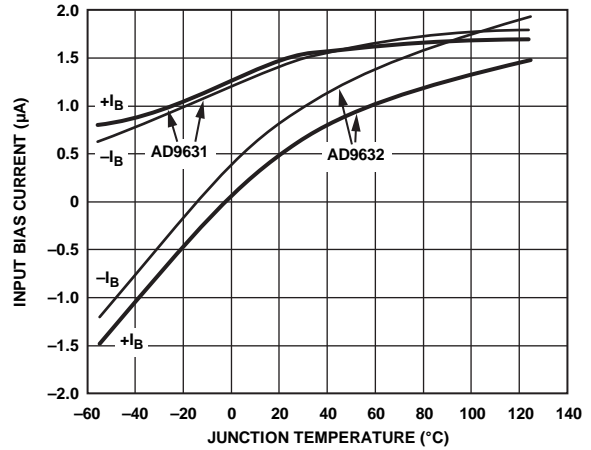

Figure 57. Input Bias Current vs. Temperature

09601-067

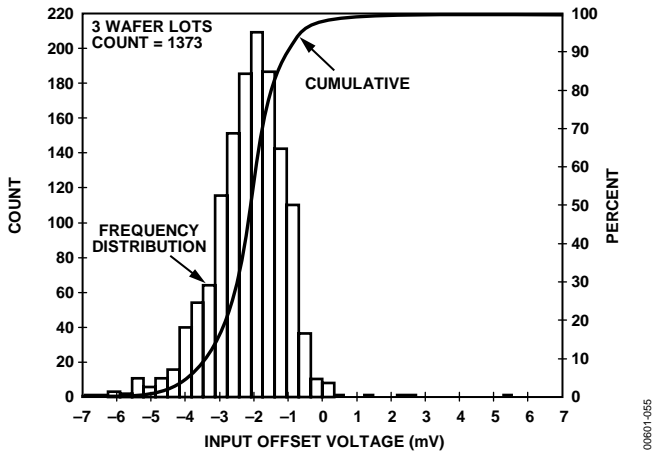

Figure 55. AD9631 Input Offset Voltage Distribution

09601-065

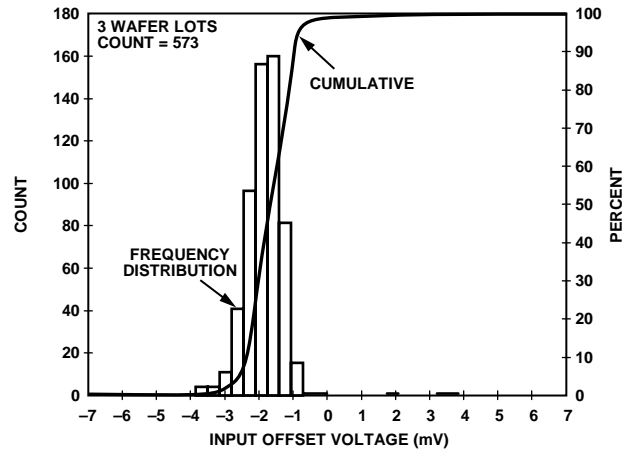

Figure 58. AD9632 Input Offset Voltage Distribution

09601-068

THEORY OF OPERATION

GENERAL

The AD9631/AD9632 are wide bandwidth, voltage feedback amplifiers. Because their open-loop frequency response follows the conventional 6 dB/octave roll-off, their gain bandwidth product is basically constant. Increasing their closed-loop gain results in a corresponding decrease in small signal bandwidth. This can be observed by noting the bandwidth specification between the AD9631 (gain of +1) and AD9632 (gain of +2). The AD9631/AD9632 typically maintain 65° of phase margin. This high margin minimizes the effects of signal and noise peaking.

FEEDBACK RESISTOR CHOICE

The value of the feedback resistor is critical for optimum performance on the AD9631 (gain of +1) and less critical as the gain increases. Therefore, this section is specifically targeted at the AD9631.

At the minimum stable gain (+1), the AD9631 provides optimum dynamic performance with $R_F = 140 \Omega$. This resistor acts as a parasitic suppressor only against damped RF oscillations that can occur due to lead (input, feedback) inductance and parasitic capacitance. This value of R_F provides the best combination of wide bandwidth, low parasitic peaking, and fast settling time.

In fact, for the same reasons, place a 100 Ω to 130 Ω resistor in series with the positive input for other AD9631 noninverting and all AD9631 inverting configurations. The correct connection is shown in Figure 59 and Figure 60.

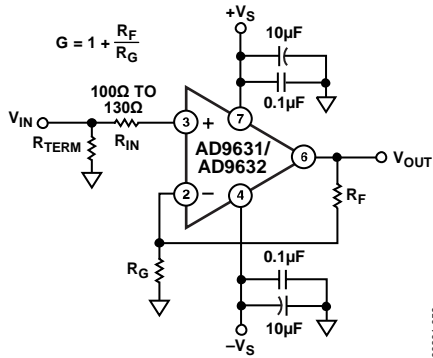

Figure 59. Noninverting Operation

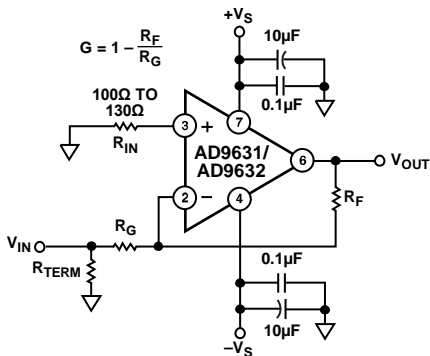

Figure 60. Inverting Operation

When the AD9631 is used in the transimpedance (I to V) mode, such as in photodiode detection, the value of R_F and diode capacitance (C_I) are usually known. Generally, the value of R_F selected will be in the $k\Omega$ range, and a shunt capacitor (C_F) across R_F will be required to maintain good amplifier stability. The value of C_F required to maintain optimal flatness (<1 dB peaking) and settling time can be estimated by

$$C_F \cong \left[(2\omega_0 C_I R_F - 1) / \omega_0^2 R_F^2 \right]^{\frac{1}{2}}$$

where:

ω_0 is equal to the unity gain bandwidth product of the amplifier in rad/sec.

C_I is the equivalent total input capacitance at the inverting input.

Typically $\omega_0 = 800 \times 10^6$ rad/sec (see Figure 19).

As an example, choosing $R_F = 10 k\Omega$ and $C_I = 5 pF$ requires C_F to be 1.1 pF (Note that C_I includes both source and parasitic circuit capacitance). The bandwidth of the amplifier can be estimated using C_F :

$$f_{3dB} \cong \frac{1.6}{2\pi R_F C_F}$$

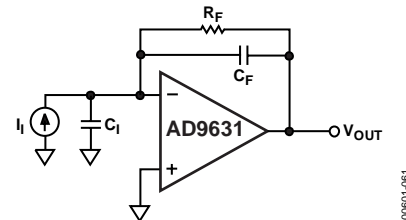

Figure 61. Transimpedance Configuration

For general voltage gain applications, the amplifier bandwidth can be closely estimated as

$$f_{3dB} \cong \frac{\omega_0}{2\pi(1 + R_F / R_G)}$$

This estimation loses accuracy for gains of +2/-1 or lower due to the damping factor of the amplifier. For these low gain cases, the bandwidth will actually extend beyond the calculated value (see Figure 17 and Figure 29).

As a general rule, Capacitor C_F will not be required if

$$(R_F \parallel R_G) \times C_I \leq \frac{NG}{4\omega_0}$$

where NG is the noise gain ($1 + R_F/R_G$) of the circuit. For most voltage gain applications, this should be the case.

PULSE RESPONSE

Unlike a traditional voltage feedback amplifier, where the slew speed is dictated by its front end dc quiescent current and gain bandwidth product, the AD9631/AD9632 provide on-demand current that increases proportionally to the input step signal amplitude. This results in slew rates (1300 V/ μ s) comparable to wideband current feedback designs. This, combined with relatively low input noise current (2.0 pA/ $\sqrt{\text{Hz}}$), gives the AD9631/AD9632 the best attributes of both voltage and current feedback amplifiers.

LARGE SIGNAL PERFORMANCE

The outstanding large signal operation of the AD9631 and AD9632 is due to a unique, proprietary design architecture. To maintain this level of performance, the maximum $550 \text{ V} \times \text{MHz}$ product must be observed (for example, @ 100 MHz, $V_{\text{OUT}} \leq 5.5 \text{ V p-p}$).

POWER SUPPLY BYPASSING

Adequate power supply bypassing can be critical when optimizing the performance of a high frequency circuit. Inductance in the power supply leads can form resonant circuits that produce peaking in the amplifier's response. In addition, if large current transients must be delivered to the load, then bypass capacitors (typically greater than 1 μF) will be required to provide the best settling time and lowest distortion. A parallel combination of at least 4.7 μF , and between 0.1 μF and 0.01 μF , is recommended. Some brands of electrolytic capacitors will require a small series damping resistor $\approx 4.7 \Omega$ for optimum results.

DRIVING CAPACITIVE LOADS

The AD9631/AD9632 were designed primarily to drive non-reactive loads. If driving loads with a capacitive component is desired, the best frequency response is obtained by the addition of a small series resistance as shown in Figure 62. Figure 63 shows the optimum value for R_{SERIES} vs. capacitive load. It is worth noting that the frequency response of the circuit when driving large capacitive loads will be dominated by the passive roll-off of R_{SERIES} and C_L .

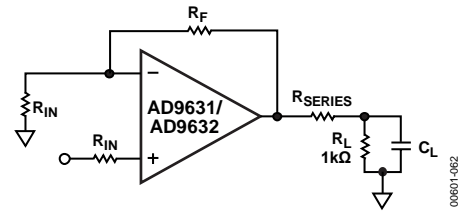

Figure 62. Driving Capacitive Loads

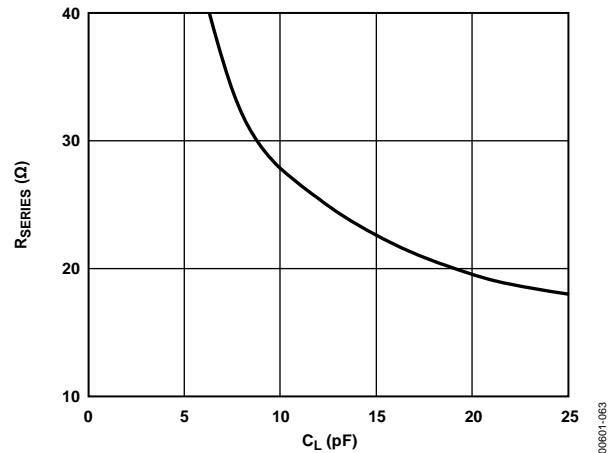

Figure 63. Recommended R_{SERIES} vs. Capacitive Load

APPLICATIONS INFORMATION

The AD9631/AD9632 are voltage feedback amplifiers well suited for applications such as photodetectors, active filters, and log amplifiers. The wide bandwidth (320 MHz), phase margin (65°), low current noise (2.0 pA/√Hz), and slew rate (1300 V/μs) of the devices give higher performance capabilities to these applications over previous voltage feedback designs.

With a settling time of 16 ns to 0.01% and 11 ns to 0.1%, the devices are an excellent choice for DAC I/V conversion. The same characteristics along with low harmonic distortion make them a good choice for ADC buffering/amplification. With superb linearity at relatively high signal frequencies, the AD9631/AD9632 are ideal drivers for ADCs up to 12 bits.

OPERATION AS A VIDEO LINE DRIVER

The AD9631/AD9632 have been designed to offer outstanding performance as video line drivers. The important specifications of differential gain (0.02%) and differential phase (0.02°) meet the most exacting HDTV demands for driving video loads.

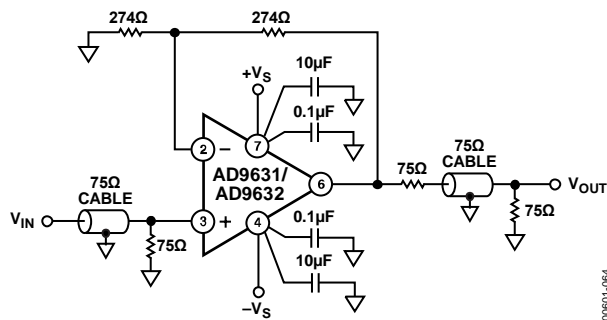

Figure 64. Video Line Driver

ACTIVE FILTERS

The wide bandwidth and low distortion of the AD9631/AD9632 are ideal for the realization of higher bandwidth active filters. These characteristics, while being more common in many current feedback op amps, are offered in the AD9631/AD9632 in a voltage feedback configuration. Many active filter configurations are not realizable with current feedback amplifiers.

A multiple feedback active filter requires a voltage feedback amplifier and is more demanding of op amp performance than other active filter configurations, such as the Sallen-Key. In general, the amplifier should have a bandwidth that is at least 10 times the bandwidth of the filter if problems due to phase shift of the amplifier are to be avoided.

Figure 65 is an example of a 20 MHz low-pass multiple feedback active filter using an AD9632.

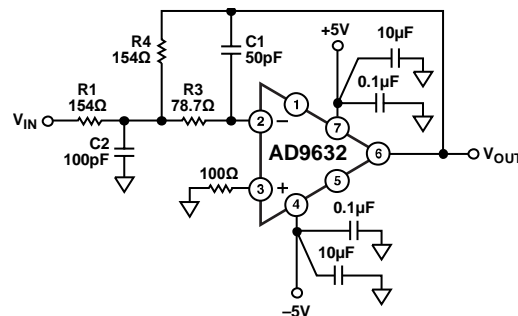

Figure 65. Active Filter Circuit

Choose

$$F_o = \text{cutoff frequency} = 20 \text{ MHz}$$

$$\alpha = \text{damping ratio} = 1/Q = 2$$

$$H = \text{absolute value of circuit gain} = \left| \frac{-R4}{R1} \right| = 1$$

Then

$$k = 2\pi F_o C1$$

$$C2 = \frac{4C1(H+1)}{\alpha^2}$$

$$R1 = \frac{\alpha}{2HK}$$

$$R3 = \frac{\alpha}{2K(H+1)}$$

$$R4 = H(R1)$$

ANALOG-TO-DIGITAL CONVERTER (ADC) DRIVER

As ADCs move toward higher speeds with higher resolutions, there becomes a need for high performance drivers that will not degrade the analog signal to the converter. It is desirable from a system's standpoint that the ADC be the element in the signal chain that ultimately limits overall distortion. Figure 66 is such an example.

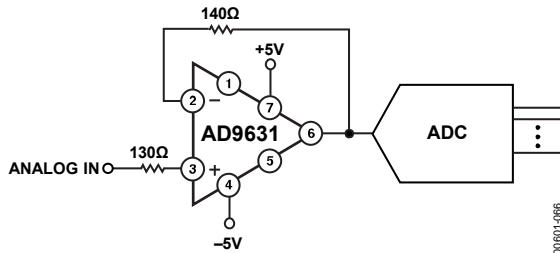

Figure 66. AD9631 Used as Driver for an ADC Signal Chain

LAYOUT CONSIDERATIONS

The specified high speed performance of the AD9631/AD9632 requires careful attention to board layout and component selection. Proper RF design techniques and low-pass parasitic component selection are mandatory.

The PCB should have a ground plane covering all unused portions of the component side of the board to provide a low impedance path. Remove the ground plane from the area near the input pins to reduce stray capacitance.

Use chip capacitors for supply bypassing (see Figure 59 and Figure 60). Connect one end to the ground plane, and the other within 1/8 inch of each power pin. Connect an additional large (0.47 μ F to 10 μ F) tantalum electrolytic capacitor in parallel, though not necessarily so close, to supply current for fast, large signal changes at the output.

The feedback resistor should be located close to the inverting input pin to keep the stray capacitance at this node to a minimum. Capacitance variations of less than 1 pF at the inverting input will significantly affect high speed performance.

Use stripline design techniques for long signal traces (greater than about 1 inch). These should be designed with a characteristic impedance of 50 Ω or 75 Ω and be properly terminated at each end.

OUTLINE DIMENSIONS

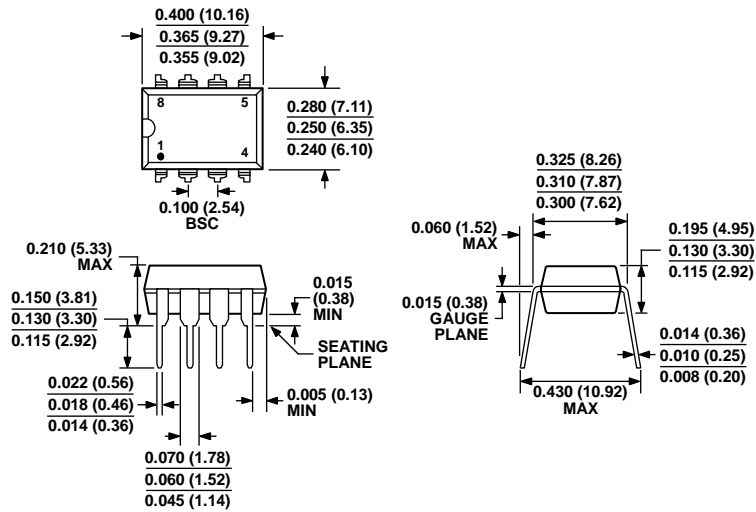

COMPLIANT TO JEDEC STANDARDS MS-001
 CONTROLLING DIMENSIONS ARE IN INCHES; MILLIMETER DIMENSIONS (IN PARENTHESES) ARE ROUNDED-OFF INCH EQUIVALENTS FOR REFERENCE ONLY AND ARE NOT APPROPRIATE FOR USE IN DESIGN. CORNER LEADS MAY BE CONFIGURED AS WHOLE OR HALF LEADS.

Figure 67. 8-Lead Plastic Dual In-Line Package [PDIP] Narrow Body (N-8)

Dimensions shown in inches and (millimeters)

070606-A

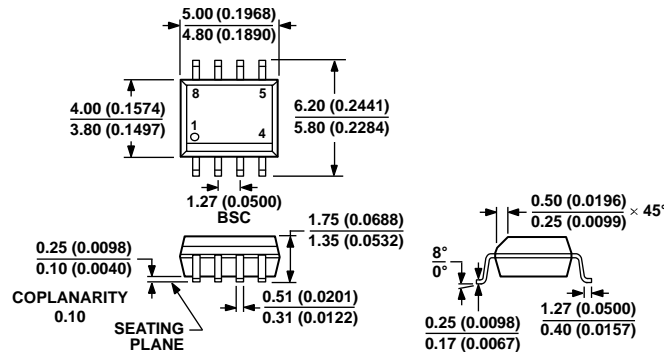

COMPLIANT TO JEDEC STANDARDS MS-012-AA
 CONTROLLING DIMENSIONS ARE IN MILLIMETERS; INCH DIMENSIONS (IN PARENTHESES) ARE ROUNDED-OFF MILLIMETER EQUIVALENTS FOR REFERENCE ONLY AND ARE NOT APPROPRIATE FOR USE IN DESIGN.

Figure 68. 8-Lead Standard Small Outline Package [SOIC_N] Narrow Body (R-8)

Dimensions shown in millimeters and (inches)

012407-A

ORDERING GUIDE

Model ¹	Temperature Range	Package Description	Package Option
AD9631ANZ	-40°C to +85°C	8-Lead Plastic Dual In-Line Package [PDIP]	N-8
AD9631AR	-40°C to +85°C	8-Lead Standard Small Outline Package [SOIC_N]	R-8
AD9631AR-REEL	-40°C to +85°C	8-Lead Standard Small Outline Package [SOIC_N]	R-8
AD9631AR-REEL7	-40°C to +85°C	8-Lead Standard Small Outline Package [SOIC_N]	R-8
AD9631ARZ	-40°C to +85°C	8-Lead Standard Small Outline Package [SOIC_N]	R-8
AD9631ARZ-REEL	-40°C to +85°C	8-Lead Standard Small Outline Package [SOIC_N]	R-8
AD9631ARZ-REEL7	-40°C to +85°C	8-Lead Standard Small Outline Package [SOIC_N]	R-8
AD9631AR-EBZ		AD9631 Evaluation Board	
AD9631ACHIPS		Die	
AD9632ANZ	-40°C to +85°C	8-Lead Plastic Dual In-Line Package [PDIP]	N-8
AD9632AR	-40°C to +85°C	8-Lead Standard Small Outline Package [SOIC_N]	R-8
AD9632ARZ	-40°C to +85°C	8-Lead Standard Small Outline Package [SOIC_N]	R-8
AD9632ARZ-REEL	-40°C to +85°C	8-Lead Standard Small Outline Package [SOIC_N]	R-8
AD9632ARZ-REEL7	-40°C to +85°C	8-Lead Standard Small Outline Package [SOIC_N]	R-8
AD9632AR-EBZ		AD9632 Evaluation Board	

¹ Z = RoHS Compliant Part.

Looking for pricing, stock, or lifecycle information?

Click below to explore more details on WIN SOURCE:

 [View AD9631ARZ on WIN SOURCE](#)

 [Analog Devices Inc. Information](#)

Optimize Your Supply Chain with WIN SOURCE Solutions

-  Global Sourcing Solution
-  Obsolete Management
-  Cost Control Management
-  Shortage Management
-  Alternative Solution
-  Excess Inventory Management