



**THE DATASHEET OF  
TLC272CDRG4**



- **Trimmed Offset Voltage:**  
TLC277 . . . 500  $\mu\text{V}$  Max at 25°C,  
 $V_{\text{DD}} = 5\text{ V}$
- **Input Offset Voltage Drift . . . Typically**  
0.1  $\mu\text{V}/\text{Month}$ , Including the First 30 Days
- **Wide Range of Supply Voltages Over Specified Temperature Range:**  
0°C to 70°C . . . 3 V to 16 V  
–40°C to 85°C . . . 4 V to 16 V  
–55°C to 125°C . . . 4 V to 16 V
- **Single-Supply Operation**
- **Common-Mode Input Voltage Range Extends Below the Negative Rail (C-Suffix, I-Suffix types)**
- **Low Noise . . . Typically 25 nV/ $\sqrt{\text{Hz}}$  at  $f = 1\text{ kHz}$**
- **Output Voltage Range Includes Negative Rail**
- **High Input impedance . . .  $10^{12}\ \Omega$  Typ**
- **ESD-Protection Circuitry**
- **Small-Outline Package Option Also Available in Tape and Reel**
- **Designed-In Latch-Up Immunity**

**D, JG, P, OR PW PACKAGE  
(TOP VIEW)**



**FK PACKAGE  
(TOP VIEW)**

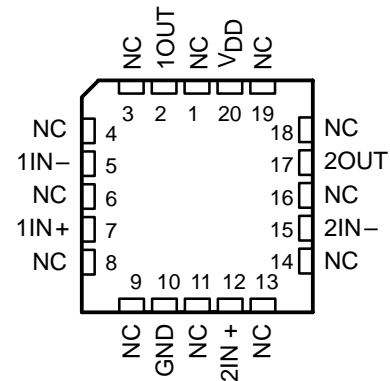

NC – No internal connection

## description

The TLC272 and TLC277 precision dual operational amplifiers combine a wide range of input offset voltage grades with low offset voltage drift, high input impedance, low noise, and speeds approaching those of general-purpose BiFET devices.

These devices use Texas Instruments silicon-gate LinCMOS™ technology, which provides offset voltage stability far exceeding the stability available with conventional metal-gate processes.

The extremely high input impedance, low bias currents, and high slew rates make these cost-effective devices ideal for applications previously reserved for BiFET and NFET products. Four offset voltage grades are available (C-suffix and I-suffix types), ranging from the low-cost TLC272 (10 mV) to the high-precision TLC277 (500  $\mu\text{V}$ ). These advantages, in combination with good common-mode rejection and supply voltage rejection, make these devices a good choice for new state-of-the-art designs as well as for upgrading existing designs.

LinCMOS is a trademark of Texas Instruments.

**DISTRIBUTION OF TLC277  
INPUT OFFSET VOLTAGE**

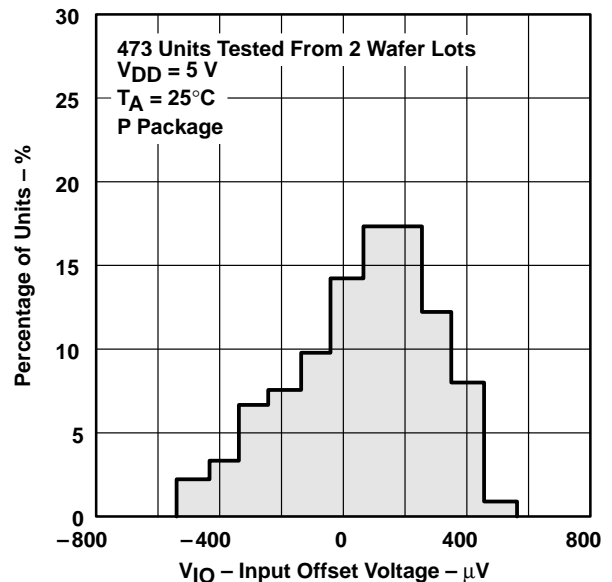

PRODUCTION DATA information is current as of publication date. Products conform to specifications per the terms of Texas Instruments standard warranty. Production processing does not necessarily include testing of all parameters.

# TLC272, TLC272A, TLC272B, TLC272Y, TLC277 LinCMOS™ PRECISION DUAL OPERATIONAL AMPLIFIERS

SLOS091E – OCTOBER 1987 – REVISED FEBRUARY 2002

## description (continued)

AVAILABLE OPTIONS							
T <sub>A</sub>	V <sub>IO</sub> max AT 25°C	PACKAGED DEVICES					CHIP FORM (Y)
		SMALL OUTLINE (D)	CHIP CARRIER (FK)	CERAMIC DIP (JG)	PLASTIC DIP (P)	TSSOP (PW)	
0°C to 70°C	500 μV	TLC277CD	—	—	TLC277CP	—	—
	2 mV	TLC272BCD	—	—	TLC272BCP	—	—
	5 mV	TLC272ACD	—	—	TLC272ACP	—	—
	10mV	TLC272CD	—	—	TLC272CP	TLC272CPW	TLC272Y
–40°C to 85°C	500 μV	TLC277ID	—	—	TLC277IP	—	—
	2 mV	TLC272BID	—	—	TLC272BIP	—	—
	5 mV	TLC272AID	—	—	TLC272AIP	—	—
	10 mV	TLC272ID	—	—	TLC272IP	—	—

The D package is available taped and reeled. Add R suffix to the device type (e.g., TLC277CDR).

In general, many features associated with bipolar technology are available on LinCMOS™ operational amplifiers without the power penalties of bipolar technology. General applications such as transducer interfacing, analog calculations, amplifier blocks, active filters, and signal buffering are easily designed with the TLC272 and TLC277. The devices also exhibit low voltage single-supply operation, making them ideally suited for remote and inaccessible battery-powered applications. The common-mode input voltage range includes the negative rail.

A wide range of packaging options is available, including small-outline and chip carrier versions for high-density system applications.

The device inputs and outputs are designed to withstand –100-mA surge currents without sustaining latch-up.

The TLC272 and TLC277 incorporate internal ESD-protection circuits that prevent functional failures at voltages up to 2000 V as tested under MIL-STD-883C, Method 3015.2; however, care should be exercised in handling these devices as exposure to ESD may result in the degradation of the device parametric performance.

The C-suffix devices are characterized for operation from 0°C to 70°C. The I-suffix devices are characterized for operation from –40°C to 85°C. The M-suffix devices are characterized for operation over the full military temperature range of –55°C to 125°C.



equivalent schematic (each amplifier)

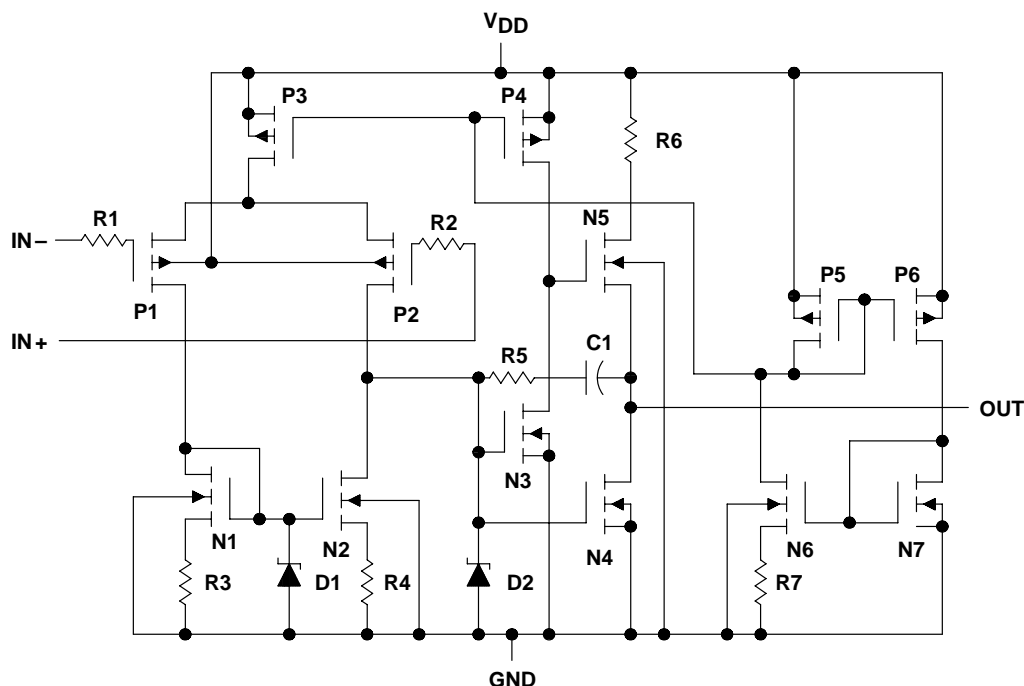

### TLC272Y chip information

This chip, when properly assembled, displays characteristics similar to the TLC272C. Thermal compression or ultrasonic bonding may be used on the doped-aluminum bonding pads. Chips may be mounted with conductive epoxy or a gold-silicon preform.

**BONDING PAD ASSIGNMENTS**

**CHIP THICKNESS: 15 TYPICAL**  
**BONDING PADS: 4 × 4 MINIMUM**  
**T<sub>jmax</sub> = 150°C**  
**TOLERANCES ARE ±10%.**  
**ALL DIMENSIONS ARE IN MILS.**  
**PIN (4) IS INTERNALLY CONNECTED TO BACKSIDE OF CHIP.**



# TLC272, TLC272A, TLC272B, TLC272Y, TLC277 LinCMOS™ PRECISION DUAL OPERATIONAL AMPLIFIERS

SLOS091E – OCTOBER 1987 – REVISED FEBRUARY 2002

**electrical characteristics at specified free-air temperature,  $V_{DD} = 5\text{ V}$  (unless otherwise noted)**

PARAMETER		TEST CONDITIONS		$T_A$ †	TLC272C, TLC272AC, TLC272BC, TLC277C			UNIT
					MIN	TYP	MAX	
$V_{IO}$	Input offset voltage	TLC272C	$V_O = 1.4\text{ V},$ $R_S = 50\ \Omega,$	$V_{IC} = 0,$ $R_L = 10\text{ k}\Omega$	25°C	1.1	10	mV
					Full range		12	
		TLC272AC	$V_O = 1.4\text{ V},$ $R_S = 50\ \Omega,$	$V_{IC} = 0,$ $R_L = 10\text{ k}\Omega$	25°C	0.9	5	
					Full range		6.5	
		TLC272BC	$V_O = 1.4\text{ V},$ $R_S = 50\ \Omega,$	$V_{IC} = 0,$ $R_L = 10\text{ k}\Omega$	25°C	230	2000	$\mu\text{V}$
					Full range		3000	
		TLC277C	$V_O = 1.4\text{ V},$ $R_S = 50\ \Omega,$	$V_{IC} = 0,$ $R_L = 10\text{ k}\Omega$	25°C	200	500	
					Full range		1500	
$\alpha_{VIO}$	Temperature coefficient of input offset voltage			25°C to 70°C	1.8		$\mu\text{V}/^\circ\text{C}$	
$I_{IO}$	Input offset current (see Note 4)	$V_O = 2.5\text{ V},$	$V_{IC} = 2.5\text{ V}$	25°C	0.1	60	pA	
$I_{IB}$	Input bias current (see Note 4)			70°C	7	300		
				25°C	0.6	60	pA	
				70°C	40	600		
$V_{ICR}$	Common-mode input voltage range (see Note 5)			25°C	-0.2 to 4	-0.3 to 4.2	V	
				Full range	-0.2 to 3.5		V	
$V_{OH}$	High-level output voltage	$V_{ID} = 100\text{ mV},$	$R_L = 10\text{ k}\Omega$	25°C	3.2	3.8	V	
				0°C	3	3.8		
				70°C	3	3.8		
$V_{OL}$	Low-level output voltage	$V_{ID} = -100\text{ mV},$	$I_{OL} = 0$	25°C		0 50	mV	
				0°C		0 50		
				70°C		0 50		
$A_{VD}$	Large-signal differential voltage amplification	$V_O = 0.25\text{ V to } 2\text{ V},$	$R_L = 10\text{ k}\Omega$	25°C	5	23	V/mV	
				0°C	4	27		
				70°C	4	20		
CMRR	Common-mode rejection ratio	$V_{IC} = V_{ICRmin}$		25°C	65	80	dB	
				0°C	60	84		
				70°C	60	85		
$k_{SVR}$	Supply-voltage rejection ratio ( $\Delta V_{DD}/\Delta V_{IO}$ )	$V_{DD} = 5\text{ V to } 10\text{ V},$	$V_O = 1.4\text{ V}$	25°C	65	95	dB	
				0°C	60	94		
				70°C	60	96		
$I_{DD}$	Supply current (two amplifiers)	$V_O = 2.5\text{ V},$ No load	$V_{IC} = 2.5\text{ V},$	25°C	1.4	3.2	mA	
				0°C	1.6	3.6		
				70°C	1.2	2.6		

† Full range is 0°C to 70°C.

NOTES: 4. The typical values of input bias current and input offset current below 5 pA were determined mathematically.

5. This range also applies to each input individually.



# TLC272, TLC272A, TLC272B, TLC272Y, TLC277 LinCMOS™ PRECISION DUAL OPERATIONAL AMPLIFIERS

SLOS091E – OCTOBER 1987 – REVISED FEBRUARY 2002

## electrical characteristics at specified free-air temperature, $V_{DD} = 10\text{ V}$ (unless otherwise noted)

PARAMETER		TEST CONDITIONS		$T_A$ †	TLC272C, TLC272AC, TLC272BC, TLC277C			UNIT
					MIN	TYP	MAX	
$V_{IO}$	Input offset voltage	TLC272C	$V_O = 1.4\text{ V}$ , $R_S = 50\ \Omega$	$V_{IC} = 0$ , $R_L = 10\text{ k}\Omega$	25°C	1.1	10	mV
					Full range		12	
	TLC272AC	$V_O = 1.4\text{ V}$ , $R_S = 50\ \Omega$	$V_{IC} = 0$ , $R_L = 10\text{ k}\Omega$	25°C	0.9	5	mV	
				Full range		6.5		
	TLC272BC	$V_O = 1.4\text{ V}$ , $R_S = 50\ \Omega$	$V_{IC} = 0$ , $R_L = 10\text{ k}\Omega$	25°C	290	2000	$\mu\text{V}$	
				Full range		3000		
	TLC277C	$V_O = 1.4\text{ V}$ , $R_S = 50\ \Omega$	$V_{IC} = 0$ , $R_L = 10\text{ k}\Omega$	25°C	250	800	$\mu\text{V}$	
				Full range		1900		
$\alpha_{VIO}$	Temperature coefficient of input offset voltage			25°C to 70°C	2		$\mu\text{V}/^\circ\text{C}$	
$I_{IO}$	Input offset current (see Note 4)	$V_O = 5\text{ V}$ , $V_{IC} = 5\text{ V}$		25°C	0.1	60	pA	
$I_{IB}$	Input bias current (see Note 4)			70°C	7	300		
				25°C	0.7	60	pA	
70°C	50			600				
$V_{ICR}$	Common-mode input voltage range (see Note 5)			25°C	-0.2 to 9	-0.3 to 9.2	V	
				Full range	-0.2 to 8.5		V	
$V_{OH}$	High-level output voltage	$V_{ID} = 100\text{ mV}$ ,	$R_L = 10\text{ k}\Omega$	25°C	8	8.5	V	
				0°C	7.8	8.5		
				70°C	7.8	8.4		
$V_{OL}$	Low-level output voltage	$V_{ID} = -100\text{ mV}$ ,	$I_{OL} = 0$	25°C	0	50	mV	
				0°C	0	50		
				70°C	0	50		
$A_{VD}$	Large-signal differential voltage amplification	$V_O = 1\text{ V to }6\text{ V}$ ,	$R_L = 10\text{ k}\Omega$	25°C	10	36	V/mV	
				0°C	7.5	42		
				70°C	7.5	32		
CMRR	Common-mode rejection ratio	$V_{IC} = V_{ICRmin}$		25°C	65	85	dB	
				0°C	60	88		
				70°C	60	88		
$k_{SVR}$	Supply-voltage rejection ratio ( $\Delta V_{DD}/\Delta V_{IO}$ )	$V_{DD} = 5\text{ V to }10\text{ V}$ ,	$V_O = 1.4\text{ V}$	25°C	65	95	dB	
				0°C	60	94		
				70°C	60	96		
$I_{DD}$	Supply current (two amplifiers)	$V_O = 5\text{ V}$ , No load	$V_{IC} = 5\text{ V}$ ,	25°C	1.9	4	mA	
				0°C	2.3	4.4		
				70°C	1.6	3.4		

† Full range is 0°C to 70°C.

NOTES: 4. The typical values of input bias current and input offset current below 5 pA were determined mathematically.

5. This range also applies to each input individually.



# TLC272, TLC272A, TLC272B, TLC272Y, TLC277 LinCMOS™ PRECISION DUAL OPERATIONAL AMPLIFIERS

SLOS091E – OCTOBER 1987 – REVISED FEBRUARY 2002

**electrical characteristics at specified free-air temperature,  $V_{DD} = 5\text{ V}$  (unless otherwise noted)**

PARAMETER		TEST CONDITIONS		$T_A$ †	TLC272I, TLC272AI, TLC272BI, TLC277I			UNIT
					MIN	TYP	MAX	
$V_{IO}$	Input offset voltage	TLC272I	$V_O = 1.4\text{ V},$ $R_S = 50\ \Omega,$	$V_{IC} = 0,$ $R_L = 10\text{ k}\Omega$	25°C	1.1	10	mV
					Full range		13	
		TLC272AI	$V_O = 1.4\text{ V},$ $R_S = 50\ \Omega,$	$V_{IC} = 0,$ $R_L = 10\text{ k}\Omega$	25°C	0.9	5	
					Full range		7	
		TLC272BI	$V_O = 1.4\text{ V},$ $R_S = 50\ \Omega,$	$V_{IC} = 0,$ $R_L = 10\text{ k}\Omega$	25°C	230	2000	$\mu\text{V}$
					Full range		3500	
		TLC277I	$V_O = 1.4\text{ V},$ $R_S = 50\ \Omega,$	$V_{IC} = 0,$ $R_L = 10\text{ k}\Omega$	25°C	200	500	
					Full range		2000	
$\alpha_{VIO}$	Temperature coefficient of input offset voltage			25°C to 85°C	1.8		$\mu\text{V}/^\circ\text{C}$	
$I_{IO}$	Input offset current (see Note 4)	$V_O = 2.5\text{ V},$	$V_{IC} = 2.5\text{ V}$	25°C	0.1	60	pA	
$I_{IB}$	Input bias current (see Note 4)			85°C	24	15		
				25°C	0.6	60	pA	
				85°C	200	35		
$V_{ICR}$	Common-mode input voltage range (see Note 5)			25°C	-0.2 to 4	-0.3 to 4.2	V	
				Full range	-0.2 to 3.5		V	
$V_{OH}$	High-level output voltage	$V_{ID} = 100\text{ mV},$	$R_L = 10\text{ k}\Omega$	25°C	3.2	3.8	V	
				-40°C	3	3.8		
				85°C	3	3.8		
$V_{OL}$	Low-level output voltage	$V_{ID} = -100\text{ mV},$	$I_{OL} = 0$	25°C		0 50	mV	
				-40°C		0 50		
				85°C		0 50		
$A_{VD}$	Large-signal differential voltage amplification	$V_O = 1\text{ V to }6\text{ V},$	$R_L = 10\text{ k}\Omega$	25°C	5	23	V/mV	
				-40°C	3.5	32		
				85°C	3.5	19		
CMRR	Common-mode rejection ratio	$V_{IC} = V_{ICR\text{min}}$		25°C	65	80	dB	
				-40°C	60	81		
				85°C	60	86		
$k_{SVR}$	Supply-voltage rejection ratio ( $\Delta V_{DD}/\Delta V_{IO}$ )	$V_{DD} = 5\text{ V to }10\text{ V},$	$V_O = 1.4\text{ V}$	25°C	65	95	dB	
				-40°C	60	92		
				85°C	60	96		
$I_{DD}$	Supply current (two amplifiers)	$V_O = 2.5\text{ V},$ No load	$V_{IC} = 2.5\text{ V},$	25°C	1.4	3.2	mA	
				-40°C	1.9	4.4		
				85°C	1.1	2.4		

† Full range is -40°C to 85°C.

NOTES: 4. The typical values of input bias current and input offset current below 5 pA were determined mathematically.

5. This range also applies to each input individually.



# TLC272, TLC272A, TLC272B, TLC272Y, TLC277 LinCMOS™ PRECISION DUAL OPERATIONAL AMPLIFIERS

SLOS091E – OCTOBER 1987 – REVISED FEBRUARY 2002

## electrical characteristics at specified free-air temperature, $V_{DD} = 10\text{ V}$ (unless otherwise noted)

PARAMETER		TEST CONDITIONS		$T_A$ †	TLC272I, TLC272AI, TLC272BI, TLC277I			UNIT
					MIN	TYP	MAX	
$V_{IO}$	Input offset voltage	TLC272I	$V_O = 1.4\text{ V}$ , $R_S = 50\ \Omega$	$V_{IC} = 0$ , $R_L = 10\text{ k}\Omega$	25°C	1.1	10	mV
					Full range		13	
	TLC272AI	$V_O = 1.4\text{ V}$ , $R_S = 50\ \Omega$	$V_{IC} = 0$ , $R_L = 10\text{ k}\Omega$	25°C	0.9	5		
				Full range		7		
	TLC272BI	$V_O = 1.4\text{ V}$ , $R_S = 50\ \Omega$	$V_{IC} = 0$ , $R_L = 10\text{ k}\Omega$	25°C	290	2000	$\mu\text{V}$	
				Full range		3500		
	TLC277I	$V_O = 1.4\text{ V}$ , $R_S = 50\ \Omega$	$V_{IC} = 0$ , $R_L = 10\text{ k}\Omega$	25°C	250	800		
				Full range		2900		
$\alpha_{VIO}$	Temperature coefficient of input offset voltage			25°C to 85°C	2		$\mu\text{V}/^\circ\text{C}$	
$I_{IO}$	Input offset current (see Note 4)	$V_O = 5\text{ V}$ , $V_{IC} = 5\text{ V}$		25°C	0.1	60	pA	
$I_{IB}$	Input bias current (see Note 4)			85°C	26	1000		
				25°C	0.7	60	pA	
85°C	220			2000				
$V_{ICR}$	Common-mode input voltage range (see Note 5)			25°C	-0.2 to 9	-0.3 to 9.2	V	
				Full range	-0.2 to 8.5		V	
$V_{OH}$	High-level output voltage	$V_{ID} = 100\text{ mV}$ , $R_L = 10\text{ k}\Omega$		25°C	8	8.5	V	
				-40°C	7.8	8.5		
				85°C	7.8	8.5		
$V_{OL}$	Low-level output voltage	$V_{ID} = -100\text{ mV}$ , $I_{OL} = 0$		25°C	0	50	mV	
				-40°C	0	50		
				85°C	0	50		
$A_{VD}$	Large-signal differential voltage amplification	$V_O = 1\text{ V to }6\text{ V}$ , $R_L = 10\text{ k}\Omega$		25°C	10	36	V/mV	
				-40°C	7	46		
				85°C	7	31		
CMRR	Common-mode rejection ratio	$V_{IC} = V_{ICRmin}$		25°C	65	85	dB	
				-40°C	60	87		
				85°C	60	88		
$k_{SVR}$	Supply-voltage rejection ratio ( $\Delta V_{DD}/\Delta V_{IO}$ )	$V_{DD} = 5\text{ V to }10\text{ V}$ , $V_O = 1.4\text{ V}$		25°C	65	95	dB	
				-40°C	60	92		
				85°C	60	96		
$I_{DD}$	Supply current (two amplifiers)	$V_O = 5\text{ V}$ , No load	$V_{IC} = 5\text{ V}$	25°C	1.4	4	mA	
				-40°C	2.8	5		
				85°C	1.5	3.2		

† Full range is -40°C to 85°C.

NOTES: 4. The typical values of input bias current and input offset current below 5 pA were determined mathematically.

5. This range also applies to each input individually.



# TLC272, TLC272A, TLC272B, TLC272Y, TLC277 LinCMOS™ PRECISION DUAL OPERATIONAL AMPLIFIERS

SLOS091E – OCTOBER 1987 – REVISED FEBRUARY 2002

**electrical characteristics at specified free-air temperature,  $V_{DD} = 5\text{ V}$  (unless otherwise noted)**

PARAMETER		TEST CONDITIONS		$T_A$ †	TLC272M, TLC277M			UNIT
					MIN	TYP	MAX	
$V_{IO}$	Input offset voltage	TLC272M	$V_O = 1.4\text{ V}$ , $R_S = 50\ \Omega$ ,	$V_{IC} = 0$ , $R_L = 10\text{ k}\Omega$	25°C	1.1	10	mV
					Full range		12	
		TLC277M	$V_O = 1.4\text{ V}$ , $R_S = 50\ \Omega$ ,	$V_{IC} = 0$ , $R_L = 10\text{ k}\Omega$	25°C	200	500	$\mu\text{V}$
					Full range		3750	
$\alpha_{VIO}$	Temperature coefficient of input offset voltage			25°C to 125°C	2.1		$\mu\text{V}/^\circ\text{C}$	
$I_{IO}$	Input offset current (see Note 4)	$V_O = 2.5\text{ V}$	$V_{IC} = 2.5\text{ V}$	25°C	0.1	60	pA	
				125°C	1.4	15	nA	
$I_{IB}$	Input bias current (see Note 4)			25°C	0.6	60	pA	
				125°C	9	35	nA	
$V_{ICR}$	Common-mode input voltage range (see Note 5)			25°C	0 to 4	-0.3 to 4.2	V	
				Full range	0 to 3.5		V	
$V_{OH}$	High-level output voltage	$V_{ID} = 100\text{ mV}$ ,	$R_L = 10\text{ k}\Omega$	25°C	3.2	3.8	V	
				-55°C	3	3.8		
				125°C	3	3.8		
$V_{OL}$	Low-level output voltage	$V_{ID} = -100\text{ mV}$ ,	$I_{OL} = 0$	25°C	0	50	mV	
				-55°C	0	50		
				125°C	0	50		
$A_{VD}$	Large-signal differential voltage amplification	$V_O = 0.25\text{ V to }2\text{ V}$	$R_L = 10\text{ k}\Omega$	25°C	5	23	V/mV	
				-55°C	3.5	35		
				125°C	3.5	16		
CMRR	Common-mode rejection ratio	$V_{IC} = V_{ICRmin}$		25°C	65	80	dB	
				-55°C	60	81		
				125°C	60	84		
$k_{SVR}$	Supply-voltage rejection ratio ( $\Delta V_{DD}/\Delta V_{IO}$ )	$V_{DD} = 5\text{ V to }10\text{ V}$ ,	$V_O = 1.4\text{ V}$	25°C	65	95	dB	
				-55°C	60	90		
				125°C	60	97		
$I_{DD}$	Supply current (two amplifiers)	$V_O = 2.5\text{ V}$ , No load	$V_{IC} = 2.5\text{ V}$ ,	25°C	1.4	3.2	mA	
				-55°C	2	5		
				125°C	1	2.2		

† Full range is -55°C to 125°C.

- NOTES: 4. The typical values of input bias current and input offset current below 5 pA were determined mathematically.  
5. This range also applies to each input individually.



# TLC272, TLC272A, TLC272B, TLC272Y, TLC277 LinCMOS™ PRECISION DUAL OPERATIONAL AMPLIFIERS

SLOS091E – OCTOBER 1987 – REVISED FEBRUARY 2002

## electrical characteristics at specified free-air temperature, $V_{DD} = 10\text{ V}$ (unless otherwise noted)

PARAMETER		TEST CONDITIONS		$T_A$ †	TLC272M, TLC277M			UNIT
					MIN	TYP	MAX	
$V_{IO}$	Input offset voltage	TLC272M	$V_O = 1.4\text{ V}$ , $R_S = 50\ \Omega$	$V_{IC} = 0$ , $R_L = 10\text{ k}\Omega$	25°C	1.1	10	mV
					Full range		12	
		TLC277M	$V_O = 1.4\text{ V}$ , $R_S = 50\ \Omega$	$V_{IC} = 0$ , $R_L = 10\text{ k}\Omega$	25°C	250	800	$\mu\text{V}$
					Full range		4300	
$\alpha_{VIO}$	Temperature coefficient of input offset voltage			25°C to 125°C	2.2		$\mu\text{V}/^\circ\text{C}$	
$I_{IO}$	Input offset current (see Note 4)	$V_O = 5\text{ V}$ ,	$V_{IC} = 5\text{ V}$	25°C	0.1	60	pA	
				125°C	1.8	15	nA	
$I_{IB}$	Input bias current (see Note 4)			25°C	0.7	60	pA	
				125°C	10	35	nA	
$V_{ICR}$	Common-mode input voltage range (see Note 5)			25°C	0 to 9	-0.3 to 9.2	V	
				Full range	0 to 8.5		V	
$V_{OH}$	High-level output voltage	$V_{ID} = 100\text{ mV}$ ,	$R_L = 10\text{ k}\Omega$	25°C	8	8.5	V	
				-55°C	7.8	8.5		
				125°C	7.8	8.4		
$V_{OL}$	Low-level output voltage	$V_{ID} = -100\text{ mV}$ ,	$I_{OL} = 0$	25°C	0	50	mV	
				-55°C	0	50		
				125°C	0	50		
$AVD$	Large-signal differential voltage amplification	$V_O = 1\text{ V to }6\text{ V}$ ,	$R_L = 10\text{ k}\Omega$	25°C	10	36	V/mV	
				-55°C	7	50		
				125°C	7	27		
$CMRR$	Common-mode rejection ratio	$V_{IC} = V_{ICRmin}$		25°C	65	85	dB	
				-55°C	60	87		
				125°C	60	86		
$k_{SVR}$	Supply-voltage rejection ratio ( $\Delta V_{DD}/\Delta V_{IO}$ )	$V_{DD} = 5\text{ V to }10\text{ V}$ ,	$V_O = 1.4\text{ V}$	25°C	65	95	dB	
				-55°C	60	90		
				125°C	60	97		
$I_{DD}$	Supply current (two amplifiers)	$V_O = 5\text{ V}$ , No load	$V_{IC} = 5\text{ V}$ ,	25°C	1.9	4	mA	
				-55°C	3	6		
				125°C	1.3	2.8		

† Full range is -55°C to 125°C.

NOTES: 4. The typical values of input bias current and input offset current below 5 pA were determined mathematically.

5. This range also applies to each input individually.



# TLC272, TLC272A, TLC272B, TLC272Y, TLC277 LinCMOS™ PRECISION DUAL OPERATIONAL AMPLIFIERS

SLOS091E – OCTOBER 1987 – REVISED FEBRUARY 2002

## electrical characteristics, $V_{DD} = 5\text{ V}$ , $T_A = 25^\circ\text{C}$ (unless otherwise noted)

PARAMETER	TEST CONDITIONS	TLC272Y			UNIT
		MIN	TYP	MAX	
$V_{IO}$ Input offset voltage	$V_O = 1.4\text{ V}$ , $R_S = 50\ \Omega$ , $V_{IC} = 0$ , $R_L = 10\ \text{k}\Omega$		1.1	10	mV
$\alpha_{V_{IO}}$ Temperature coefficient of input offset voltage			1.8		$\mu\text{V}/^\circ\text{C}$
$I_{IO}$ Input offset current (see Note 4)	$V_O = 2.5\text{ V}$ , $V_{IC} = 2.5\text{ V}$		0.1		pA
$I_{IB}$ Input bias current (see Note 4)			0.6		pA
$V_{ICR}$ Common-mode input voltage range (see Note 5)		-0.2 to 4	-0.3 to 4.2		V
$V_{OH}$ High-level output voltage	$V_{ID} = 100\text{ mV}$ , $R_L = 10\ \text{k}\Omega$	3.2	3.8		V
$V_{OL}$ Low-level output voltage	$V_{ID} = -100\text{ mV}$ , $I_{OL} = 0$		0	50	mV
$A_{VD}$ Large-signal differential voltage amplification	$V_O = 0.25\text{ V to }2\text{ V}$ , $R_L = 10\ \text{k}\Omega$	5	23		V/mV
CMRR Common-mode rejection ratio	$V_{IC} = V_{ICRmin}$	65	80		dB
$k_{SVR}$ Supply-voltage rejection ratio ( $\Delta V_{DD}/\Delta V_{IO}$ )	$V_{DD} = 5\text{ V to }10\text{ V}$ , $V_O = 1.4\text{ V}$	65	95		dB
$I_{DD}$ Supply current (two amplifiers)	$V_O = 2.5\text{ V}$ , No load $V_{IC} = 2.5\text{ V}$		1.4	3.2	mA

NOTES: 4. The typical values of input bias current and input offset current below 5 pA were determined mathematically.  
5. This range also applies to each input individually.

## electrical characteristics, $V_{DD} = 10\text{ V}$ , $T_A = 25^\circ\text{C}$ (unless otherwise noted)

PARAMETER	TEST CONDITIONS	TLC272Y			UNIT
		MIN	TYP	MAX	
$V_{IO}$ Input offset voltage	$V_O = 1.4\text{ V}$ , $R_S = 50\ \Omega$ , $V_{IC} = 0$ , $R_L = 10\ \text{k}\Omega$		1.1	10	mV
$\alpha_{V_{IO}}$ Temperature coefficient of input offset voltage			1.8		$\mu\text{V}/^\circ\text{C}$
$I_{IO}$ Input offset current (see Note 4)	$V_O = 5\text{ V}$ , $V_{IC} = 5\text{ V}$		0.1		pA
$I_{IB}$ Input bias current (see Note 4)			0.7		pA
$V_{ICR}$ Common-mode input voltage range (see Note 5)		-0.2 to 9	-0.3 to 9.2		V
$V_{OH}$ High-level output voltage	$V_{ID} = 100\text{ mV}$ , $R_L = 10\ \text{k}\Omega$	8	8.5		V
$V_{OL}$ Low-level output voltage	$V_{ID} = -100\text{ mV}$ , $I_{OL} = 0$		0	50	mV
$A_{VD}$ Large-signal differential voltage amplification	$V_O = 1\text{ V to }6\text{ V}$ , $R_L = 10\ \text{k}\Omega$	10	36		V/mV
CMRR Common-mode rejection ratio	$V_{IC} = V_{ICRmin}$	65	85		dB
$k_{SVR}$ Supply-voltage rejection ratio ( $\Delta V_{DD}/\Delta V_{IO}$ )	$V_{DD} = 5\text{ V to }10\text{ V}$ , $V_O = 1.4\text{ V}$	65	95		dB
$I_{DD}$ Supply current (two amplifiers)	$V_O = 5\text{ V}$ , No load $V_{IC} = 5\text{ V}$		1.9	4	mA

NOTES: 4. The typical values of input bias current and input offset current below 5 pA were determined mathematically.  
5. This range also applies to each input individually.



# TLC272, TLC272A, TLC272B, TLC272Y, TLC277 LinCMOS™ PRECISION DUAL OPERATIONAL AMPLIFIERS

SLOS091E – OCTOBER 1987 – REVISED FEBRUARY 2002

## operating characteristics at specified free-air temperature, $V_{DD} = 5\text{ V}$

PARAMETER	TEST CONDITIONS		$T_A$	TLC272C, TLC272AC, TLC272BC, TLC277C			UNIT
				MIN	TYP	MAX	
SR Slew rate at unity gain	$R_L = 10\text{ k}\Omega$ , $C_L = 20\text{ pF}$ , See Figure 1	$V_{I\text{PP}} = 1\text{ V}$	25°C	3.6			V/ $\mu\text{s}$
			0°C	4			
			70°C	3			
		$V_{I\text{PP}} = 2.5\text{ V}$	25°C	2.9			
			0°C	3.1			
			70°C	2.5			
$V_n$ Equivalent input noise voltage	$f = 1\text{ kHz}$ , See Figure 2	$R_S = 20\ \Omega$	25°C	25			nV/ $\sqrt{\text{Hz}}$
$B_{\text{OM}}$ Maximum output-swing bandwidth	$V_O = V_{\text{OH}}$ , $R_L = 10\text{ k}\Omega$	$C_L = 20\text{ pF}$ , See Figure 1	25°C	320			kHz
			0°C	340			
			70°C	260			
$B_1$ Unity-gain bandwidth	$V_I = 10\text{ mV}$ , See Figure 3	$C_L = 20\text{ pF}$	25°C	1.7			MHz
			0°C	2			
			70°C	1.3			
$\phi_m$ Phase margin	$V_I = 10\text{ mV}$ , $C_L = 20\text{ pF}$	$f = B_1$ , See Figure 3	25°C	46°			
			0°C	47°			
			70°C	43°			

## operating characteristics at specified free-air temperature, $V_{DD} = 10\text{ V}$

PARAMETER	TEST CONDITIONS		$T_A$	TLC272C, TLC272AC, TLC272BC, TLC277C			UNIT
				MIN	TYP	MAX	
SR Slew rate at unity gain	$R_L = 10\text{ k}\Omega$ , $C_L = 20\text{ pF}$ , See Figure 1	$V_{I\text{PP}} = 1\text{ V}$	25°C	5.3			V/ $\mu\text{s}$
			0°C	5.9			
			70°C	4.3			
		$V_{I\text{PP}} = 5.5\text{ V}$	25°C	4.6			
			0°C	5.1			
			70°C	3.8			
$V_n$ Equivalent input noise voltage	$f = 1\text{ kHz}$ , See Figure 2	$R_S = 20\ \Omega$	25°C	25			nV/ $\sqrt{\text{Hz}}$
$B_{\text{OM}}$ Maximum output-swing bandwidth	$V_O = V_{\text{OH}}$ , $R_L = 10\text{ k}\Omega$	$C_L = 20\text{ pF}$ , See Figure 1	25°C	200			kHz
			0°C	220			
			70°C	140			
$B_1$ Unity-gain bandwidth	$V_I = 10\text{ mV}$ , See Figure 3	$C_L = 20\text{ pF}$	25°C	2.2			MHz
			0°C	2.5			
			70°C	1.8			
$\phi_m$ Phase margin	$V_I = 10\text{ mV}$ , $C_L = 20\text{ pF}$	$f = B_1$ , See Figure 3	25°C	49°			
			0°C	50°			
			70°C	46°			



# TLC272, TLC272A, TLC272B, TLC272Y, TLC277 LinCMOS™ PRECISION DUAL OPERATIONAL AMPLIFIERS

SLOS091E – OCTOBER 1987 – REVISED FEBRUARY 2002

## operating characteristics at specified free-air temperature, $V_{DD} = 5\text{ V}$

PARAMETER	TEST CONDITIONS	$T_A$	TLC272I, TLC272AI, TLC272BI, TLC277I			UNIT
			MIN	TYP	MAX	
SR      Slew rate at unity gain	$R_L = 10\text{ k}\Omega$ , $C_L = 20\text{ pF}$ , See Figure 1	$V_{I\text{PP}} = 1\text{ V}$	25°C	3.6		V/ $\mu$ s
			-40°C	4.5		
			85°C	2.8		
		$V_{I\text{PP}} = 2.5\text{ V}$	25°C	2.9		
			-40°C	3.5		
			85°C	2.3		
$V_n$ Equivalent input noise voltage	$f = 1\text{ kHz}$ , See Figure 2	$R_S = 20\ \Omega$ , 25°C	25		nV/ $\sqrt{\text{Hz}}$	
$B_{\text{OM}}$ Maximum output-swing bandwidth	$V_O = V_{\text{OH}}$ , $R_L = 10\text{ k}\Omega$ , See Figure 1	$C_L = 20\text{ pF}$ , See Figure 1	25°C	320		kHz
			-40°C	380		
			85°C	250		
$B_1$ Unity-gain bandwidth	$V_I = 10\text{ mV}$ , See Figure 3	$C_L = 20\text{ pF}$ ,	25°C	1.7		MHz
			-40°C	2.6		
			85°C	1.2		
$\phi_m$ Phase margin	$V_I = 10\text{ mV}$ , $C_L = 20\text{ pF}$ ,	$f = B_1$ , See Figure 3	25°C	46°		
			-40°C	49°		
			85°C	43°		

## operating characteristics at specified free-air temperature, $V_{DD} = 10\text{ V}$

PARAMETER	TEST CONDITIONS	$T_A$	TLC272I, TLC272AI, TLC272BI, TLC277I			UNIT
			MIN	TYP	MAX	
SR      Slew rate at unity gain	$R_L = 10\text{ k}\Omega$ , $C_L = 20\text{ pF}$ , See Figure 1	$V_{I\text{PP}} = 1\text{ V}$	25°C	5.3		V/ $\mu$ s
			-40°C	6.8		
			85°C	4		
		$V_{I\text{PP}} = 5.5\text{ V}$	25°C	4.6		
			-40°C	5.8		
			85°C	3.5		
$V_n$ Equivalent input noise voltage	$f = 1\text{ kHz}$ , See Figure 2	$R_S = 20\ \Omega$ , 25°C	25		nV/ $\sqrt{\text{Hz}}$	
$B_{\text{OM}}$ Maximum output-swing bandwidth	$V_O = V_{\text{OH}}$ , $R_L = 10\text{ k}\Omega$ , See Figure 1	$C_L = 20\text{ pF}$ , See Figure 1	25°C	200		kHz
			-40°C	260		
			85°C	130		
$B_1$ Unity-gain bandwidth	$V_I = 10\text{ mV}$ , See Figure 3	$C_L = 20\text{ pF}$ ,	25°C	2.2		MHz
			-40°C	3.1		
			85°C	1.7		
$\phi_m$ Phase margin	$V_I = 10\text{ mV}$ , $C_L = 20\text{ pF}$ ,	$f = B_1$ , See Figure 3	25°C	49°		
			-40°C	52°		
			85°C	46°		



# TLC272, TLC272A, TLC272B, TLC272Y, TLC277 LinCMOS™ PRECISION DUAL OPERATIONAL AMPLIFIERS

SLOS091E – OCTOBER 1987 – REVISED FEBRUARY 2002

## operating characteristics at specified free-air temperature, $V_{DD} = 5\text{ V}$

PARAMETER	TEST CONDITIONS	$T_A$	TLC272M, TLC277M			UNIT
			MIN	TYP	MAX	
SR Slew rate at unity gain	$R_L = 10\text{ k}\Omega$ , $C_L = 20\text{ pF}$ , See Figure 1	$V_{I\text{PP}} = 1\text{ V}$	25°C	3.6		V/ $\mu\text{s}$
			-55°C	4.7		
			125°C	2.3		
		$V_{I\text{PP}} = 2.5\text{ V}$	25°C	2.9		
			-55°C	3.7		
			125°C	2		
$V_n$ Equivalent input noise voltage	$f = 1\text{ kHz}$ , See Figure 2	$R_S = 20\ \Omega$	25°C	25		nV/ $\sqrt{\text{Hz}}$
$B_{OM}$ Maximum output-swing bandwidth	$V_O = V_{OH}$ , $R_L = 10\text{ k}\Omega$	$C_L = 20\text{ pF}$ , See Figure 1	25°C	320		kHz
			-55°C	400		
			125°C	230		
$B_1$ Unity-gain bandwidth	$V_I = 10\text{ mV}$ , See Figure 3	$C_L = 20\text{ pF}$	25°C	1.7		MHz
			-55°C	2.9		
			125°C	1.1		
$\phi_m$ Phase margin	$V_I = 10\text{ mV}$ , $C_L = 20\text{ pF}$	$f = B_1$ , See Figure 3	25°C	46°		
			-55°C	49°		
			125°C	41°		

## operating characteristics at specified free-air temperature, $V_{DD} = 10\text{ V}$

PARAMETER	TEST CONDITIONS	$T_A$	TLC272M, TLC277M			UNIT
			MIN	TYP	MAX	
SR Slew rate at unity gain	$R_L = 10\text{ k}\Omega$ , $C_L = 20\text{ pF}$ , See Figure 1	$V_{I\text{PP}} = 1\text{ V}$	25°C	5.3		V/ $\mu\text{s}$
			-55°C	7.1		
			125°C	3.1		
		$V_{I\text{PP}} = 5.5\text{ V}$	25°C	4.6		
			-55°C	6.1		
			125°C	2.7		
$V_n$ Equivalent input noise voltage	$f = 1\text{ kHz}$ , See Figure 2	$R_S = 20\ \Omega$	25°C	25		nV/ $\sqrt{\text{Hz}}$
$B_{OM}$ Maximum output-swing bandwidth	$V_O = V_{OH}$ , $R_L = 10\text{ k}\Omega$	$C_L = 20\text{ pF}$ , See Figure 1	25°C	200		kHz
			-55°C	280		
			125°C	110		
$B_1$ Unity-gain bandwidth	$V_I = 10\text{ mV}$ , See Figure 3	$C_L = 20\text{ pF}$	25°C	2.2		MHz
			-55°C	3.4		
			125°C	1.6		
$\phi_m$ Phase margin	$V_I = 10\text{ mV}$ , $C_L = 20\text{ pF}$	$f = B_1$ , See Figure 3	25°C	49°		
			-55°C	52°		
			125°C	44°		



# TLC272, TLC272A, TLC272B, TLC272Y, TLC277 LinCMOS™ PRECISION DUAL OPERATIONAL AMPLIFIERS

SLOS091E – OCTOBER 1987 – REVISED FEBRUARY 2002

## operating characteristics, $V_{DD} = 5\text{ V}$ , $T_A = 25^\circ\text{C}$

PARAMETER		TEST CONDITIONS			TLC272Y			UNIT
					MIN	TYP	MAX	
SR	Slew rate at unity gain	$R_L = 10\text{ k}\Omega$ , See Figure 1	$C_L = 20\text{ pF}$ ,	$V_{Ipp} = 1\text{ V}$	3.6			$\text{V}/\mu\text{s}$
				$V_{Ipp} = 2.5\text{ V}$	2.9			
$V_n$	Equivalent input noise voltage	$f = 1\text{ kHz}$ ,	$R_S = 20\ \Omega$ ,	See Figure 2		25		$\text{nV}/\sqrt{\text{Hz}}$
$B_{OM}$	Maximum output-swing bandwidth	$V_O = V_{OH}$ , See Figure 1	$C_L = 20\text{ pF}$ ,	$R_L = 10\text{ k}\Omega$ ,	320			kHz
$B_1$	Unity-gain bandwidth	$V_I = 10\text{ mV}$ ,	$C_L = 20\text{ pF}$ ,	See Figure 3		1.7		MHz
$\phi_m$	Phase margin	$V_I = 10\text{ mV}$ , See Figure 3	$f = B_1$ ,	$C_L = 20\text{ pF}$ ,	46°			

## operating characteristics, $V_{DD} = 10\text{ V}$ , $T_A = 25^\circ\text{C}$

PARAMETER		TEST CONDITIONS			TLC272Y			UNIT
					MIN	TYP	MAX	
SR	Slew rate at unity gain	$R_L = 10\text{ k}\Omega$ , See Figure 1	$C_L = 20\text{ pF}$ ,	$V_{Ipp} = 1\text{ V}$	5.3			$\text{V}/\mu\text{s}$
				$V_{Ipp} = 5.5\text{ V}$	4.6			
$V_n$	Equivalent input noise voltage	$f = 1\text{ kHz}$ ,	$R_S = 20\ \Omega$ ,	See Figure 2		25		$\text{nV}/\sqrt{\text{Hz}}$
$B_{OM}$	Maximum output-swing bandwidth	$V_O = V_{OH}$ , See Figure 1	$C_L = 20\text{ pF}$ ,	$R_L = 10\text{ k}\Omega$ ,	200			kHz
$B_1$	Unity-gain bandwidth	$V_I = 10\text{ mV}$ ,	$C_L = 20\text{ pF}$ ,	See Figure 3		2.2		MHz
$\phi_m$	Phase margin	$V_I = 10\text{ mV}$ , See Figure 3	$f = B_1$ ,	$C_L = 20\text{ pF}$ ,	49°			



PARAMETER MEASUREMENT INFORMATION

single-supply versus split-supply test circuits

Because the TLC272 and TLC277 are optimized for single-supply operation, circuit configurations used for the various tests often present some inconvenience since the input signal, in many cases, must be offset from ground. This inconvenience can be avoided by testing the device with split supplies and the output load tied to the negative rail. A comparison of single-supply versus split-supply test circuits is shown below. The use of either circuit gives the same result.



Figure 1. Unity-Gain Amplifier



Figure 2. Noise-Test Circuit

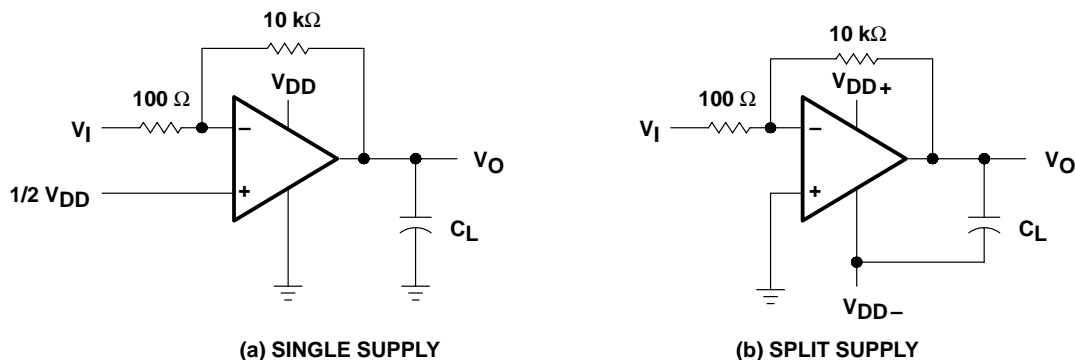

Figure 3. Gain-of-100 Inverting Amplifier

## PARAMETER MEASUREMENT INFORMATION

### input bias current

Because of the high input impedance of the TLC272 and TLC277 operational amplifiers, attempts to measure the input bias current can result in erroneous readings. The bias current at normal room ambient temperature is typically less than 1 pA, a value that is easily exceeded by leakages on the test socket. Two suggestions are offered to avoid erroneous measurements:

1. Isolate the device from other potential leakage sources. Use a grounded shield around and between the device inputs (see Figure 4). Leakages that would otherwise flow to the inputs are shunted away.
2. Compensate for the leakage of the test socket by actually performing an input bias current test (using a picoammeter) with no device in the test socket. The actual input bias current can then be calculated by subtracting the open-socket leakage readings from the readings obtained with a device in the test socket.

One word of caution: many automatic testers as well as some bench-top operational amplifier testers use the servo-loop technique with a resistor in series with the device input to measure the input bias current (the voltage drop across the series resistor is measured and the bias current is calculated). This method requires that a device be inserted into the test socket to obtain a correct reading; therefore, an open-socket reading is not feasible using this method.



Figure 4. Isolation Metal Around Device Inputs  
 (JG and P packages)

### low-level output voltage

To obtain low-supply-voltage operation, some compromise was necessary in the input stage. This compromise results in the device low-level output being dependent on the common-mode input voltage level as well as the differential input voltage level. When attempting to correlate low-level output readings with those quoted in the electrical specifications, these two conditions should be observed. If conditions other than these are to be used, please refer to Figures 14 through 19 in the Typical Characteristics of this data sheet.

### input offset voltage temperature coefficient

Erroneous readings often result from attempts to measure temperature coefficient of input offset voltage. This parameter is actually a calculation using input offset voltage measurements obtained at two different temperatures. When one (or both) of the temperatures is below freezing, moisture can collect on both the device and the test socket. This moisture results in leakage and contact resistance, which can cause erroneous input offset voltage readings. The isolation techniques previously mentioned have no effect on the leakage since the moisture also covers the isolation metal itself, thereby rendering it useless. It is suggested that these measurements be performed at temperatures above freezing to minimize error.

PARAMETER MEASUREMENT INFORMATION

full-power response

Full-power response, the frequency above which the operational amplifier slew rate limits the output voltage swing, is often specified two ways: full-linear response and full-peak response. The full-linear response is generally measured by monitoring the distortion level of the output while increasing the frequency of a sinusoidal input signal until the maximum frequency is found above which the output contains significant distortion. The full-peak response is defined as the maximum output frequency, without regard to distortion, above which full peak-to-peak output swing cannot be maintained.

Because there is no industry-wide accepted value for significant distortion, the full-peak response is specified in this data sheet and is measured using the circuit of Figure 1. The initial setup involves the use of a sinusoidal input to determine the maximum peak-to-peak output of the device (the amplitude of the sinusoidal wave is increased until clipping occurs). The sinusoidal wave is then replaced with a square wave of the same amplitude. The frequency is then increased until the maximum peak-to-peak output can no longer be maintained (Figure 5). A square wave is used to allow a more accurate determination of the point at which the maximum peak-to-peak output is reached.



Figure 5. Full-Power-Response Output Signal

test time

Inadequate test time is a frequent problem, especially when testing CMOS devices in a high-volume, short-test-time environment. Internal capacitances are inherently higher in CMOS than in bipolar and BiFET devices and require longer test times than their bipolar and BiFET counterparts. The problem becomes more pronounced with reduced supply levels and lower temperatures.

**TYPICAL CHARACTERISTICS**

**Table of Graphs**

		<b>FIGURE</b>	
$V_{IO}$	Input offset voltage	Distribution	6, 7
$\alpha_{VIO}$	Temperature coefficient of input offset voltage	Distribution	8, 9
$V_{OH}$	High-level output voltage	vs High-level output current	10, 11
		vs Supply voltage	12
		vs Free-air temperature	13
$V_{OL}$	Low-level output voltage	vs Common-mode input voltage	14, 15
		vs Differential input voltage	16
		vs Free-air temperature	17
		vs Low-level output current	18, 19
$A_{VD}$	Large-signal differential voltage amplification	vs Supply voltage	20
		vs Free-air temperature	21
		vs Frequency	32, 33
$I_{IB}$	Input bias current	vs Free-air temperature	22
$I_{IO}$	Input offset current	vs Free-air temperature	22
$V_{IC}$	Common-mode input voltage	vs Supply voltage	23
$I_{DD}$	Supply current	vs Supply voltage	24
		vs Free-air temperature	25
SR	Slew rate	vs Supply voltage	26
		vs Free-air temperature	27
	Normalized slew rate	vs Free-air temperature	28
$V_{O(PP)}$	Maximum peak-to-peak output voltage	vs Frequency	29
$B_1$	Unity-gain bandwidth	vs Free-air temperature	30
		vs Supply voltage	31
$\phi_m$	Phase margin	vs Supply voltage	34
		vs Free-air temperature	35
		vs Load capacitance	36
$V_n$	Equivalent input noise voltage	vs Frequency	37
		Phase shift	32, 33

TYPICAL CHARACTERISTICS

DISTRIBUTION OF TLC272  
 INPUT OFFSET VOLTAGE

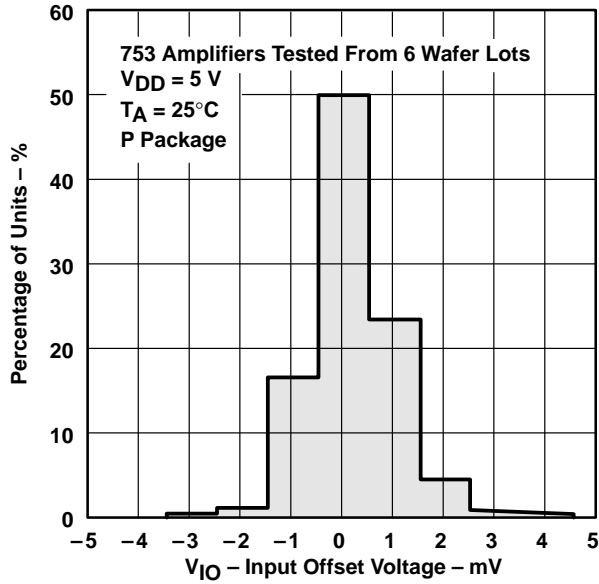

Figure 6

DISTRIBUTION OF TLC272  
 INPUT OFFSET VOLTAGE

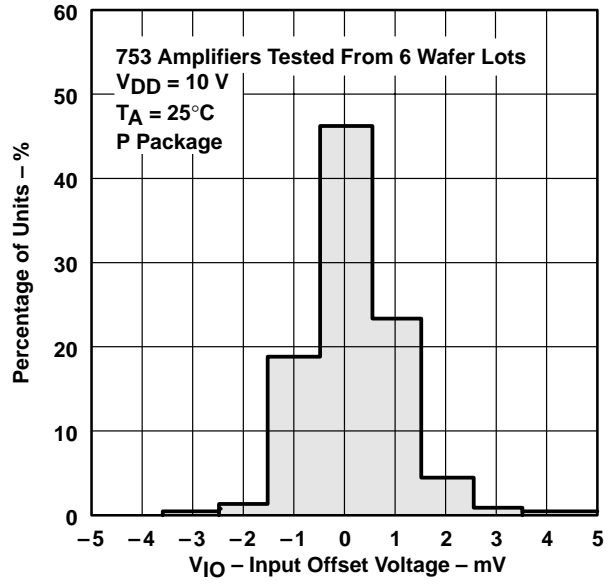

Figure 7

DISTRIBUTION OF TLC272 AND TLC277  
 INPUT OFFSET VOLTAGE  
 TEMPERATURE COEFFICIENT

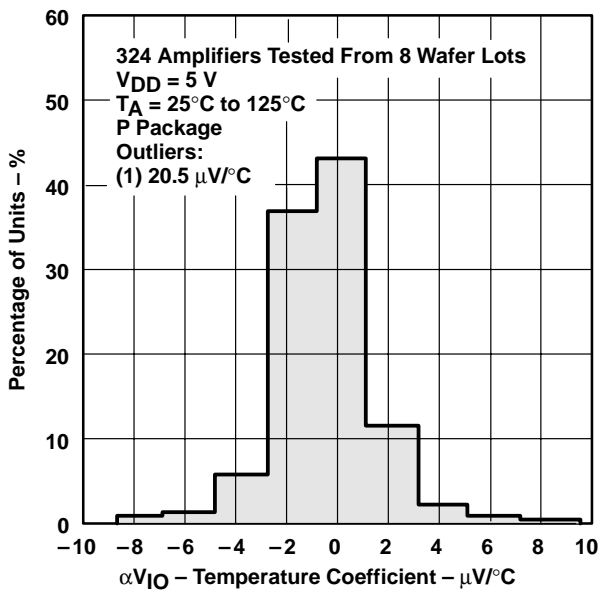

Figure 8

DISTRIBUTION OF TLC272 AND TLC277  
 INPUT OFFSET VOLTAGE  
 TEMPERATURE COEFFICIENT

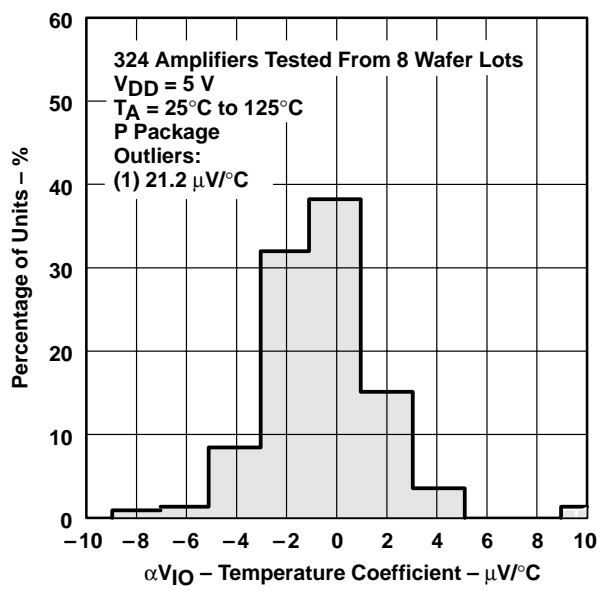
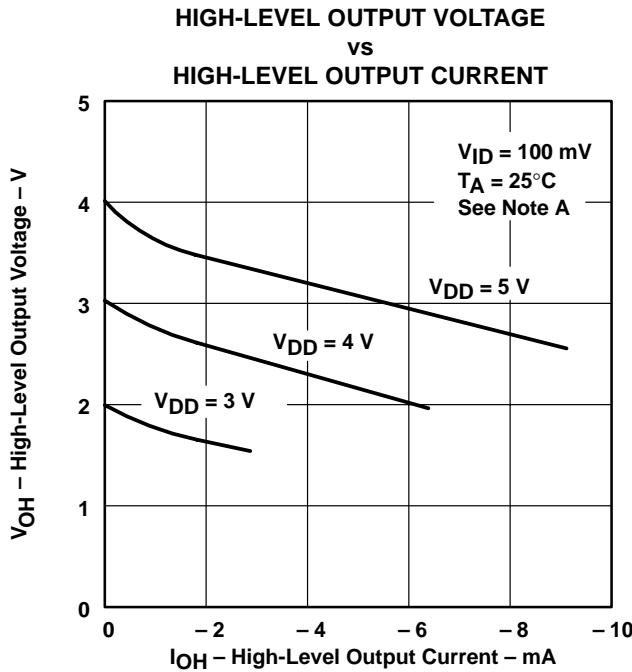

Figure 9

TYPICAL CHARACTERISTICS†



NOTE A: The 3-V curve only applies to the C version.

Figure 10



Figure 11



Figure 12



Figure 13

† Data at high and low temperatures are applicable only within the rated operating free-air temperature ranges of the various devices.

TYPICAL CHARACTERISTICS†

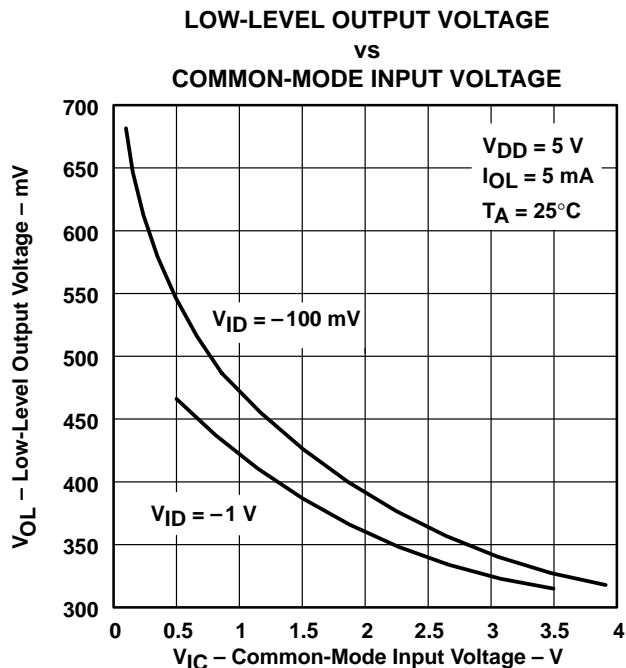

Figure 14

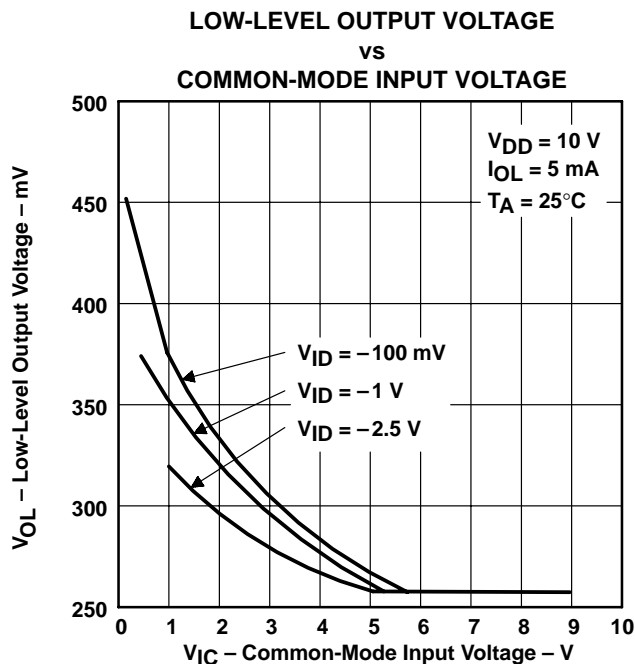

Figure 15



Figure 16



Figure 17

† Data at high and low temperatures are applicable only within the rated operating free-air temperature ranges of the various devices.

TYPICAL CHARACTERISTICS†

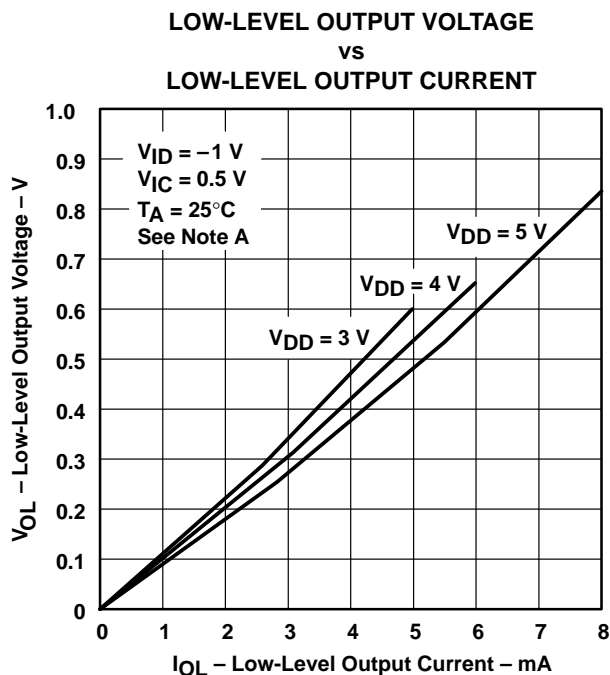

NOTE A: The 3-V curve only applies to the C version.

Figure 18

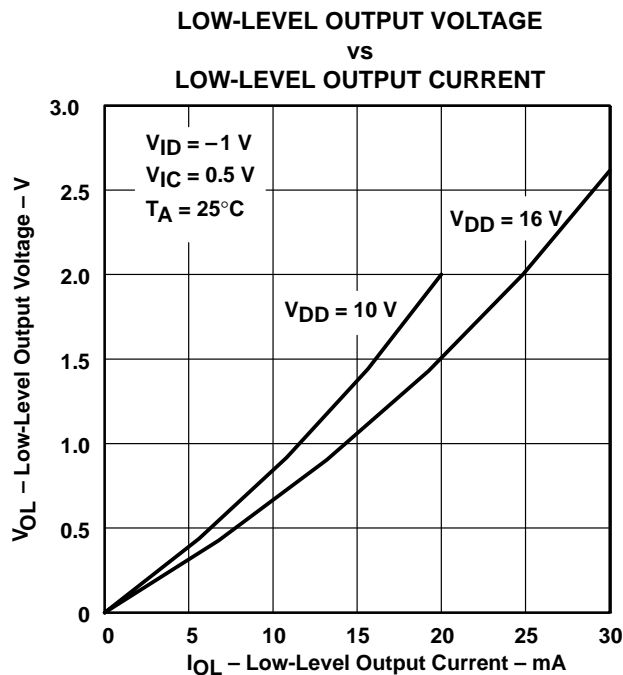

Figure 19

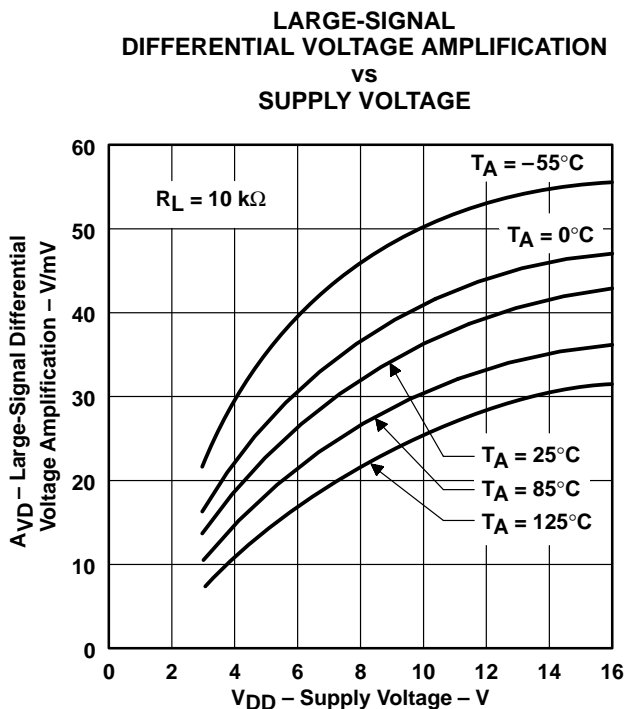

Figure 20

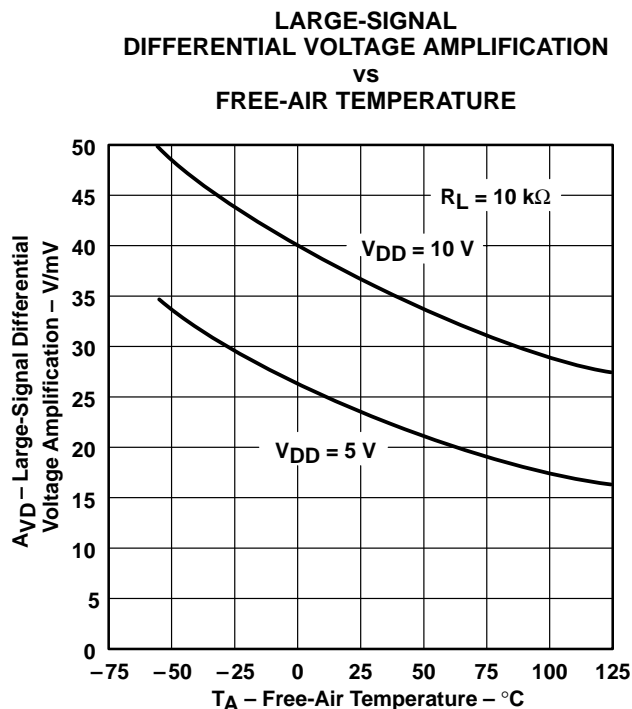

Figure 21

† Data at high and low temperatures are applicable only within the rated operating free-air temperature ranges of the various devices.

# TLC272, TLC272A, TLC272B, TLC272Y, TLC277 LinCMOS™ PRECISION DUAL OPERATIONAL AMPLIFIERS

SLOS091E – OCTOBER 1987 – REVISED FEBRUARY 2002

## TYPICAL CHARACTERISTICS†

**INPUT BIAS CURRENT AND INPUT OFFSET CURRENT  
vs  
FREE-AIR TEMPERATURE**



**Figure 22**

**COMMON-MODE  
INPUT VOLTAGE POSITIVE LIMIT  
vs  
SUPPLY VOLTAGE**



**Figure 23**

**SUPPLY CURRENT  
vs  
SUPPLY VOLTAGE**

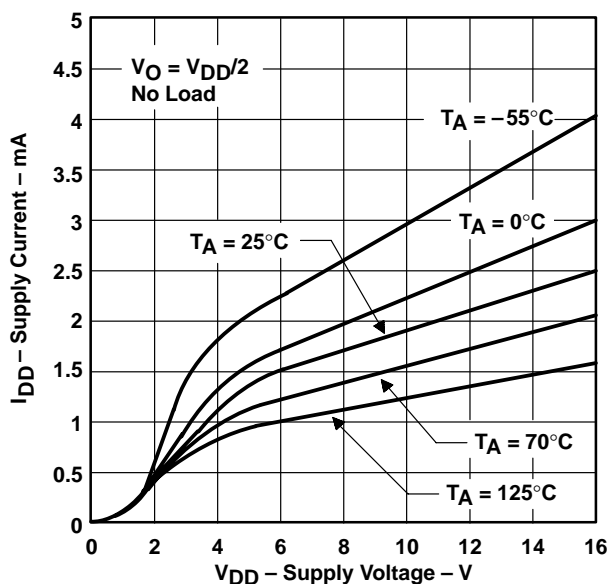

**Figure 24**

**SUPPLY CURRENT  
vs  
FREE-AIR TEMPERATURE**

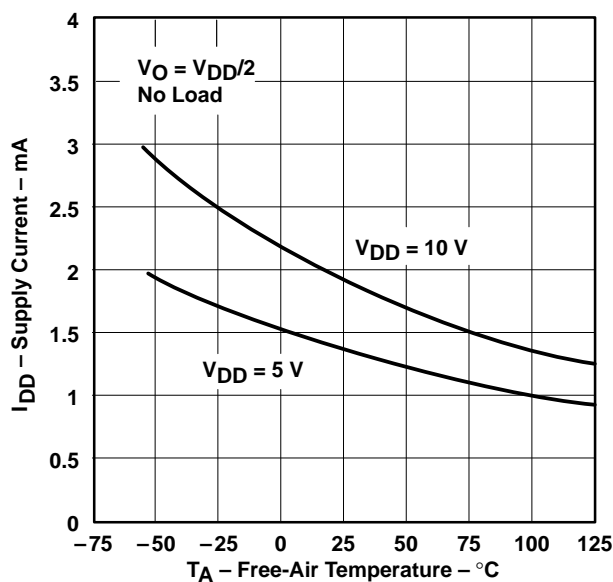

**Figure 25**

NOTE A: The typical values of input bias current and input offset current below 5 pA were determined mathematically.

† Data at high and low temperatures are applicable only within the rated operating free-air temperature ranges of the various devices.



TYPICAL CHARACTERISTICS†



Figure 26

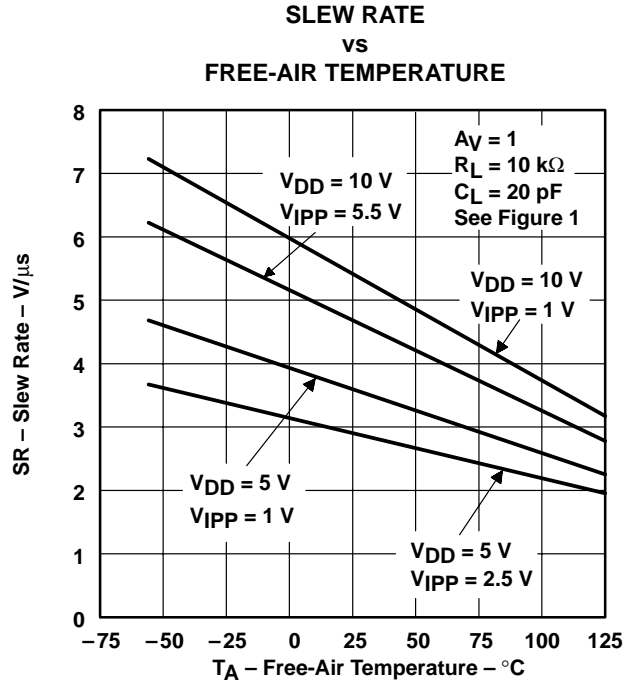

Figure 27



Figure 28

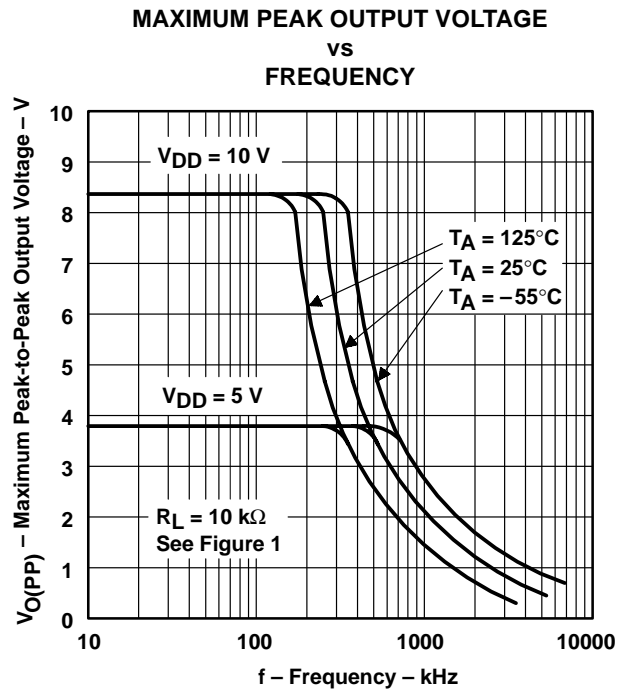

Figure 29

† Data at high and low temperatures are applicable only within the rated operating free-air temperature ranges of the various devices.

TYPICAL CHARACTERISTICS†

UNITY-GAIN BANDWIDTH  
 vs  
 FREE-AIR TEMPERATURE



Figure 30

UNITY-GAIN BANDWIDTH  
 vs  
 SUPPLY VOLTAGE

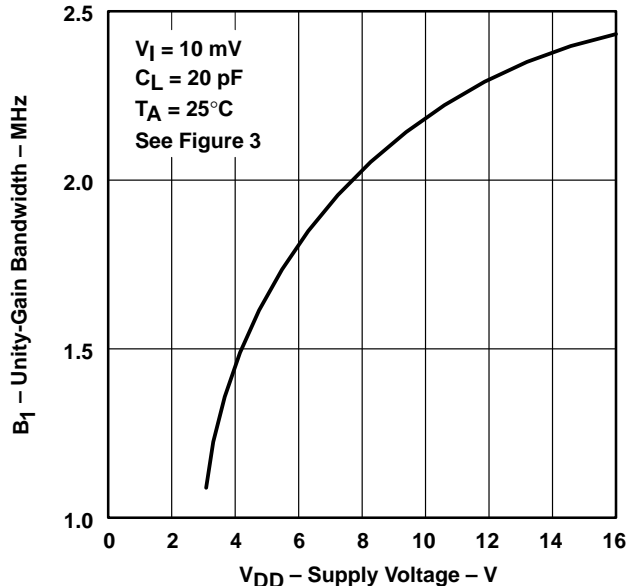

Figure 31

LARGE-SIGNAL DIFFERENTIAL VOLTAGE  
 AMPLIFICATION AND PHASE SHIFT  
 vs  
 FREQUENCY



Figure 32

† Data at high and low temperatures are applicable only within the rated operating free-air temperature ranges of the various devices.

TYPICAL CHARACTERISTICS†

LARGE-SIGNAL DIFFERENTIAL VOLTAGE  
 AMPLIFICATION AND PHASE SHIFT  
 vs  
 FREQUENCY

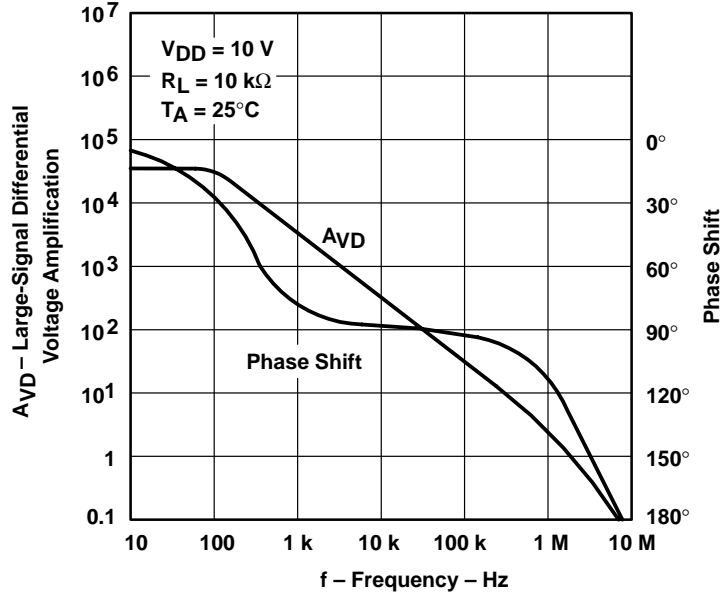

Figure 33

PHASE MARGIN  
 vs  
 SUPPLY VOLTAGE

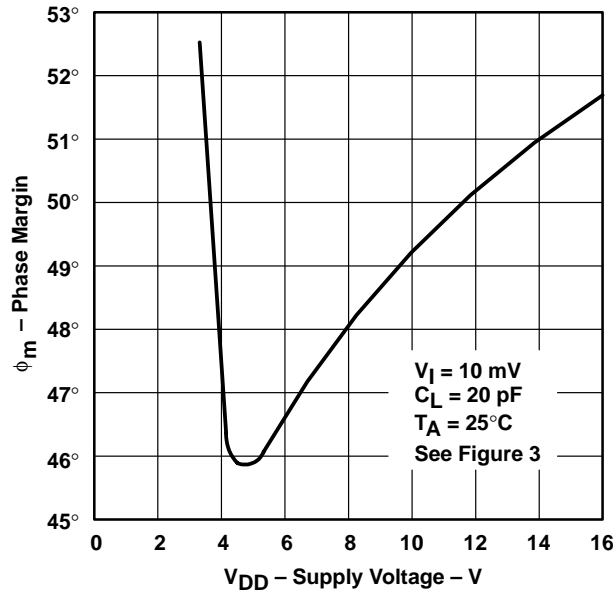

Figure 34

PHASE MARGIN  
 vs  
 FREE-AIR TEMPERATURE

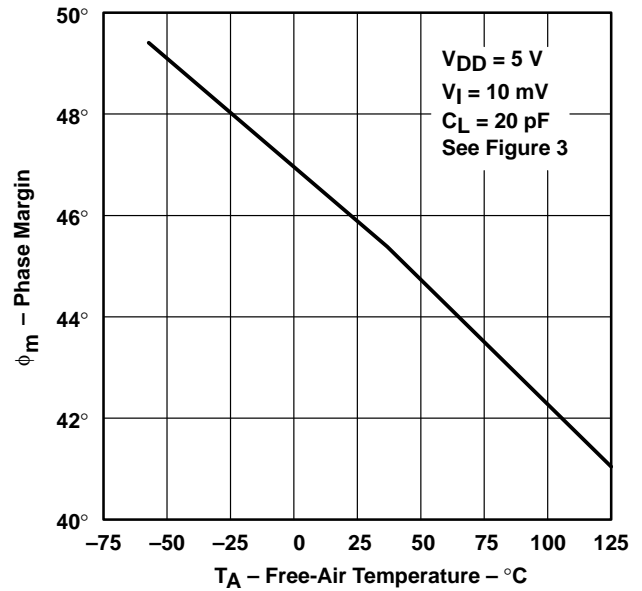

Figure 35

† Data at high and low temperatures are applicable only within the rated operating free-air temperature ranges of the various devices.

TYPICAL CHARACTERISTICS

PHASE MARGIN  
 VS  
 CAPACITIVE LOAD



Figure 36

EQUIVALENT INPUT NOISE VOLTAGE  
 VS  
 FREQUENCY



Figure 37

APPLICATION INFORMATION

single-supply operation

While the TLC272 and TLC277 perform well using dual power supplies (also called balanced or split supplies), the design is optimized for single-supply operation. This design includes an input common-mode voltage range that encompasses ground as well as an output voltage range that pulls down to ground. The supply voltage range extends down to 3 V (C-suffix types), thus allowing operation with supply levels commonly available for TTL and HCMOS; however, for maximum dynamic range, 16-V single-supply operation is recommended.

Many single-supply applications require that a voltage be applied to one input to establish a reference level that is above ground. A resistive voltage divider is usually sufficient to establish this reference level (see Figure 38). The low input bias current of the TLC272 and TLC277 permits the use of very large resistive values to implement the voltage divider, thus minimizing power consumption.

The TLC272 and TLC277 work well in conjunction with digital logic; however, when powering both linear devices and digital logic from the same power supply, the following precautions are recommended:

1. Power the linear devices from separate bypassed supply lines (see Figure 39); otherwise, the linear device supply rails can fluctuate due to voltage drops caused by high switching currents in the digital logic.
2. Use proper bypass techniques to reduce the probability of noise-induced errors. Single capacitive decoupling is often adequate; however, high-frequency applications may require RC decoupling.



Figure 38. Inverting Amplifier With Voltage Reference



Figure 39. Common vs Separate Supply Rails

**APPLICATION INFORMATION**

**input characteristics**

The TLC272 and TLC277 are specified with a minimum and a maximum input voltage that, if exceeded at either input, could cause the device to malfunction. Exceeding this specified range is a common problem, especially in single-supply operation. Note that the lower range limit includes the negative rail, while the upper range limit is specified at  $V_{DD} - 1\text{ V}$  at  $T_A = 25^\circ\text{C}$  and at  $V_{DD} - 1.5\text{ V}$  at all other temperatures.

The use of the polysilicon-gate process and the careful input circuit design gives the TLC272 and TLC277 very good input offset voltage drift characteristics relative to conventional metal-gate processes. Offset voltage drift in CMOS devices is highly influenced by threshold voltage shifts caused by polarization of the phosphorus dopant implanted in the oxide. Placing the phosphorus dopant in a conductor (such as a polysilicon gate) alleviates the polarization problem, thus reducing threshold voltage shifts by more than an order of magnitude. The offset voltage drift with time has been calculated to be typically  $0.1\ \mu\text{V}/\text{month}$ , including the first month of operation.

Because of the extremely high input impedance and resulting low bias current requirements, the TLC272 and TLC277 are well suited for low-level signal processing; however, leakage currents on printed-circuit boards and sockets can easily exceed bias current requirements and cause a degradation in device performance. It is good practice to include guard rings around inputs (similar to those of Figure 4 in the Parameter Measurement Information section). These guards should be driven from a low-impedance source at the same voltage level as the common-mode input (see Figure 40).

Unused amplifiers should be connected as grounded unity-gain followers to avoid possible oscillation.

**noise performance**

The noise specifications in operational amplifier circuits are greatly dependent on the current in the first-stage differential amplifier. The low input bias current requirements of the TLC272 and TLC277 result in a very low noise current, which is insignificant in most applications. This feature makes the devices especially favorable over bipolar devices when using values of circuit impedance greater than  $50\ \text{k}\Omega$ , since bipolar devices exhibit greater noise currents.



**Figure 40. Guard-Ring Schemes**

**output characteristics**

The output stage of the TLC272 and TLC277 is designed to sink and source relatively high amounts of current (see typical characteristics). If the output is subjected to a short-circuit condition, this high current capability can cause device damage under certain conditions. Output current capability increases with supply voltage.

All operating characteristics of the TLC272 and TLC277 are measured using a  $20\text{-pF}$  load. The devices can drive higher capacitive loads; however, as output load capacitance increases, the resulting response pole occurs at lower frequencies, thereby causing ringing, peaking, or even oscillation (see Figure 41). In many cases, adding a small amount of resistance in series with the load capacitance alleviates the problem.

APPLICATION INFORMATION

output characteristics (continued)



(a)  $C_L = 20 \text{ pF}$ ,  $R_L = \text{NO LOAD}$



(b)  $C_L = 130 \text{ pF}$ ,  $R_L = \text{NO LOAD}$



(c)  $C_L = 150 \text{ pF}$ ,  $R_L = \text{NO LOAD}$



(d) TEST CIRCUIT

$T_A = 25^\circ\text{C}$   
 $f = 1 \text{ kHz}$   
 $V_{IPP} = 1 \text{ V}$

Figure 41. Effect of Capacitive Loads and Test Circuit

Although the TLC272 and TLC277 possess excellent high-level output voltage and current capability, methods for boosting this capability are available, if needed. The simplest method involves the use of a pullup resistor ( $R_P$ ) connected from the output to the positive supply rail (see Figure 42). There are two disadvantages to the use of this circuit. First, the NMOS pulldown transistor N4 (see equivalent schematic) must sink a comparatively large amount of current. In this circuit, N4 behaves like a linear resistor with an on resistance between approximately  $60 \Omega$  and  $180 \Omega$ , depending on how hard the operational amplifier input is driven. With very low values of  $R_P$ , a voltage offset from 0 V at the output occurs. Second, pullup resistor  $R_P$  acts as a drain load to N4 and the gain of the operational amplifier is reduced at output voltage levels where N5 is not supplying the output current.

APPLICATION INFORMATION

output characteristics (continued)



$$R_p = \frac{V_{DD} - V_O}{I_F + I_L + I_P}$$

$I_p$  = Pullup current required by the operational amplifier (typically 500  $\mu$ A)

Figure 42. Resistive Pullup to Increase  $V_{OH}$



Figure 43. Compensation for Input Capacitance

feedback

Operational amplifier circuits almost always employ feedback, and since feedback is the first prerequisite for oscillation, some caution is appropriate. Most oscillation problems result from driving capacitive loads (discussed previously) and ignoring stray input capacitance. A small-value capacitor connected in parallel with the feedback resistor is an effective remedy (see Figure 43). The value of this capacitor is optimized empirically.

electrostatic discharge protection

The TLC272 and TLC277 incorporate an internal electrostatic discharge (ESD) protection circuit that prevents functional failures at voltages up to 2000 V as tested under MIL-STD-883C, Method 3015.2. Care should be exercised, however, when handling these devices as exposure to ESD may result in the degradation of the device parametric performance. The protection circuit also causes the input bias currents to be temperature dependent and have the characteristics of a reverse-biased diode.

latch-up

Because CMOS devices are susceptible to latch-up due to their inherent parasitic thyristors, the TLC272 and TLC277 inputs and outputs were designed to withstand –100-mA surge currents without sustaining latch-up; however, techniques should be used to reduce the chance of latch-up whenever possible. Internal protection diodes should not, by design, be forward biased. Applied input and output voltage should not exceed the supply voltage by more than 300 mV. Care should be exercised when using capacitive coupling on pulse generators. Supply transients should be shunted by the use of decoupling capacitors (0.1  $\mu$ F typical) located across the supply rails as close to the device as possible.

The current path established if latch-up occurs is usually between the positive supply rail and ground and can be triggered by surges on the supply lines and/or voltages on either the output or inputs that exceed the supply voltage. Once latch-up occurs, the current flow is limited only by the impedance of the power supply and the forward resistance of the parasitic thyristor and usually results in the destruction of the device. The chance of latch-up occurring increases with increasing temperature and supply voltages.

APPLICATION INFORMATION

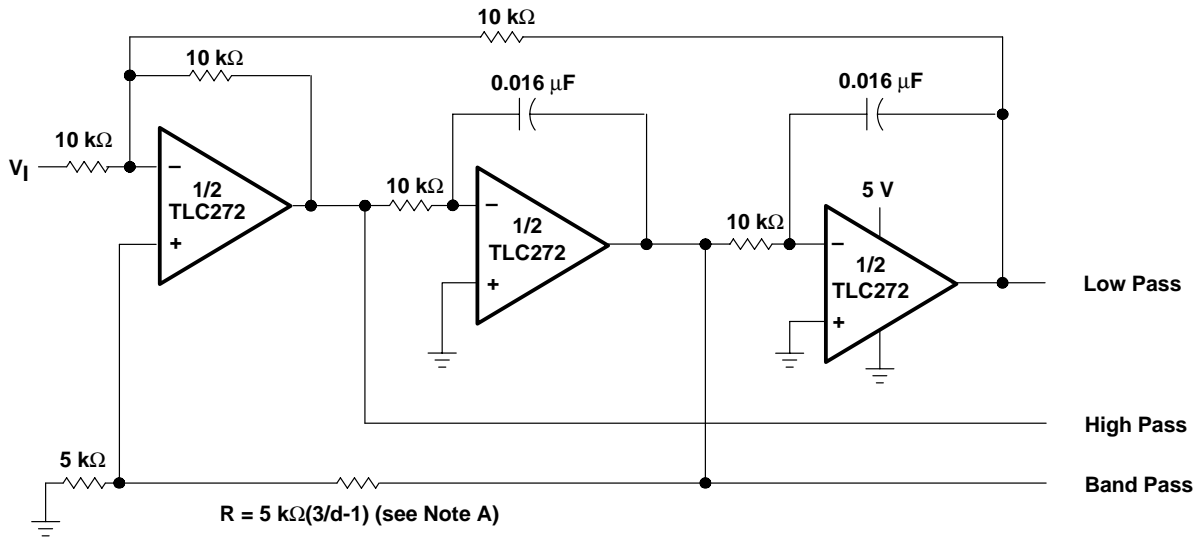

NOTE A:  $d$  = damping factor,  $1/Q$

Figure 44. State-Variable Filter

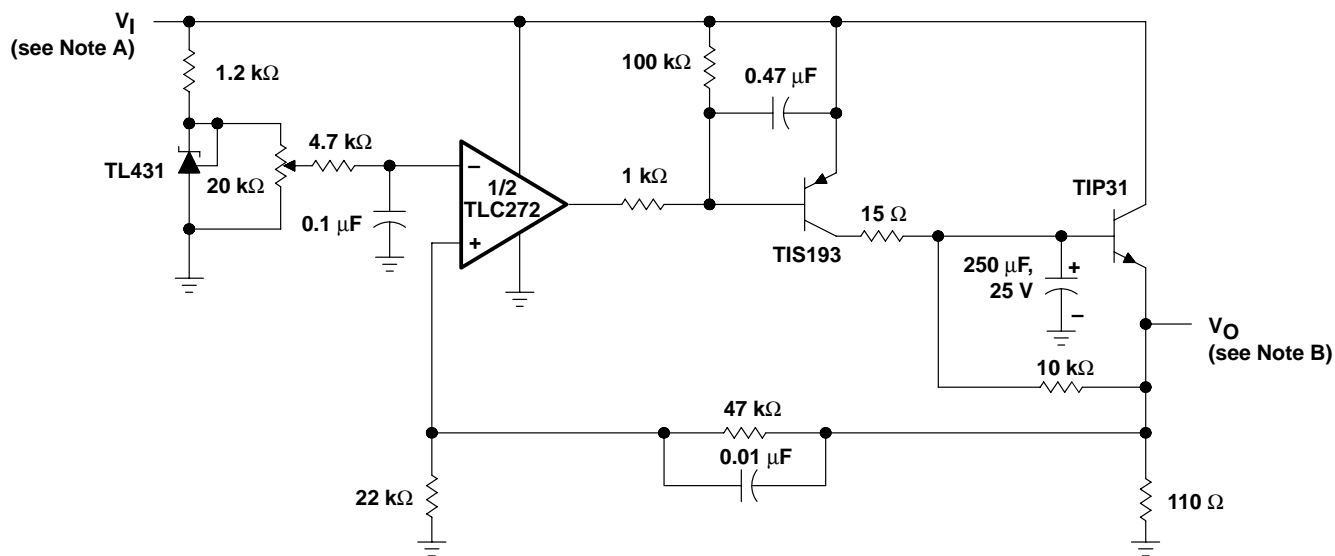

Figure 45. Positive-Peak Detector

# TLC272, TLC272A, TLC272B, TLC272Y, TLC277 LinCMOS™ PRECISION DUAL OPERATIONAL AMPLIFIERS

SLOS091E – OCTOBER 1987 – REVISED FEBRUARY 2002

## APPLICATION INFORMATION



NOTES: A.  $V_I = 3.5$  to  $15$  V  
B.  $V_O = 2$  V, 0 to 1 A

Figure 46. Logic-Array Power Supply



NOTES: A.  $V_{O(PP)} = 8$  V  
B.  $V_{O(PP)} = 4$  V

$$f_o = \frac{1}{4C(R2)} \left[ \frac{R1}{R3} \right]$$

Figure 47. Single-Supply Function Generator

APPLICATION INFORMATION



NOTE B: CMRR adjustment must be noninductive.

Figure 48. Low-Power Instrumentation Amplifier

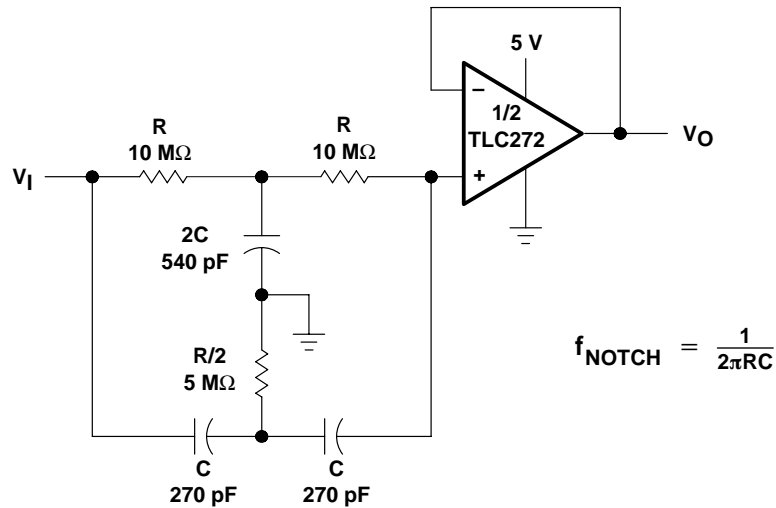

$$f_{\text{NOTCH}} = \frac{1}{2\pi RC}$$

Figure 49. Single-Supply Twin-T Notch Filter

**PACKAGING INFORMATION**

Orderable Device	Status (1)	Package Type	Package Drawing	Pins	Package Qty	Eco Plan (2)	Lead/Ball Finish (6)	MSL Peak Temp (3)	Op Temp (°C)	Device Marking (4/5)	Samples
TLC272ACD	ACTIVE	SOIC	D	8	75	Green (RoHS & no Sb/Br)	CU NIPDAU	Level-1-260C-UNLIM	0 to 70	272AC	<a href="#">Samples</a>
TLC272ACDR	ACTIVE	SOIC	D	8	2500	Green (RoHS & no Sb/Br)	CU NIPDAU	Level-1-260C-UNLIM	0 to 70	272AC	<a href="#">Samples</a>
TLC272ACP	ACTIVE	PDIP	P	8	50	Green (RoHS & no Sb/Br)	CU NIPDAU	N / A for Pkg Type	0 to 70	TLC272ACP	<a href="#">Samples</a>
TLC272ACPE4	ACTIVE	PDIP	P	8	50	Green (RoHS & no Sb/Br)	CU NIPDAU	N / A for Pkg Type	0 to 70	TLC272ACP	<a href="#">Samples</a>
TLC272AID	ACTIVE	SOIC	D	8	75	Green (RoHS & no Sb/Br)	CU NIPDAU	Level-1-260C-UNLIM	-40 to 85	272AI	<a href="#">Samples</a>
TLC272AIDR	ACTIVE	SOIC	D	8	2500	Green (RoHS & no Sb/Br)	CU NIPDAU	Level-1-260C-UNLIM	-40 to 85	272AI	<a href="#">Samples</a>
TLC272AIP	ACTIVE	PDIP	P	8	50	Green (RoHS & no Sb/Br)	CU NIPDAU	N / A for Pkg Type	-40 to 85	TLC272AIP	<a href="#">Samples</a>
TLC272BCD	ACTIVE	SOIC	D	8	75	Green (RoHS & no Sb/Br)	CU NIPDAU	Level-1-260C-UNLIM	0 to 70	272BC	<a href="#">Samples</a>
TLC272BCDR	ACTIVE	SOIC	D	8	2500	Green (RoHS & no Sb/Br)	CU NIPDAU	Level-1-260C-UNLIM	0 to 70	272BC	<a href="#">Samples</a>
TLC272BCP	ACTIVE	PDIP	P	8	50	Green (RoHS & no Sb/Br)	CU NIPDAU	N / A for Pkg Type	0 to 70	TLC272BCP	<a href="#">Samples</a>
TLC272BCPE4	ACTIVE	PDIP	P	8	50	Green (RoHS & no Sb/Br)	CU NIPDAU	N / A for Pkg Type	0 to 70	TLC272BCP	<a href="#">Samples</a>
TLC272BID	ACTIVE	SOIC	D	8	75	Green (RoHS & no Sb/Br)	CU NIPDAU	Level-1-260C-UNLIM	-40 to 85	272BI	<a href="#">Samples</a>
TLC272BIDR	ACTIVE	SOIC	D	8	2500	Green (RoHS & no Sb/Br)	CU NIPDAU	Level-1-260C-UNLIM	-40 to 85	272BI	<a href="#">Samples</a>
TLC272BIDRG4	ACTIVE	SOIC	D	8	2500	Green (RoHS & no Sb/Br)	CU NIPDAU	Level-1-260C-UNLIM	-40 to 85	272BI	<a href="#">Samples</a>
TLC272BIP	ACTIVE	PDIP	P	8	50	Green (RoHS & no Sb/Br)	CU NIPDAU	N / A for Pkg Type	-40 to 85	TLC272BIP	<a href="#">Samples</a>
TLC272CD	ACTIVE	SOIC	D	8	75	Green (RoHS & no Sb/Br)	CU NIPDAU	Level-1-260C-UNLIM	0 to 70	272C	<a href="#">Samples</a>
TLC272CDR	ACTIVE	SOIC	D	8	2500	Green (RoHS & no Sb/Br)	CU NIPDAU	Level-1-260C-UNLIM	0 to 70	272C	<a href="#">Samples</a>

Orderable Device	Status (1)	Package Type	Package Drawing	Pins	Package Qty	Eco Plan (2)	Lead/Ball Finish (6)	MSL Peak Temp (3)	Op Temp (°C)	Device Marking (4/5)	Samples
TLC272CDRG4	ACTIVE	SOIC	D	8	2500	Green (RoHS & no Sb/Br)	CU NIPDAU	Level-1-260C-UNLIM	0 to 70	272C	<a href="#">Samples</a>
TLC272CP	ACTIVE	PDIP	P	8	50	Pb-Free (RoHS)	CU NIPDAU	N / A for Pkg Type	0 to 70	TLC272CP	<a href="#">Samples</a>
TLC272CPE4	ACTIVE	PDIP	P	8	50	Pb-Free (RoHS)	CU NIPDAU	N / A for Pkg Type	0 to 70	TLC272CP	<a href="#">Samples</a>
TLC272CPSR	ACTIVE	SO	PS	8	2000	Green (RoHS & no Sb/Br)	CU NIPDAU	Level-1-260C-UNLIM	0 to 70	P272	<a href="#">Samples</a>
TLC272CPW	ACTIVE	TSSOP	PW	8	150	Green (RoHS & no Sb/Br)	CU NIPDAU	Level-1-260C-UNLIM	0 to 70	P272C	<a href="#">Samples</a>
TLC272CPWR	ACTIVE	TSSOP	PW	8	2000	Green (RoHS & no Sb/Br)	CU NIPDAU	Level-1-260C-UNLIM	0 to 70	P272C	<a href="#">Samples</a>
TLC272CPWRG4	ACTIVE	TSSOP	PW	8	2000	Green (RoHS & no Sb/Br)	CU NIPDAU	Level-1-260C-UNLIM	0 to 70	P272C	<a href="#">Samples</a>
TLC272ID	ACTIVE	SOIC	D	8	75	Green (RoHS & no Sb/Br)	CU NIPDAU	Level-1-260C-UNLIM	-40 to 85	272I	<a href="#">Samples</a>
TLC272IDG4	ACTIVE	SOIC	D	8	75	Green (RoHS & no Sb/Br)	CU NIPDAU	Level-1-260C-UNLIM	-40 to 85	272I	<a href="#">Samples</a>
TLC272IDR	ACTIVE	SOIC	D	8	2500	Green (RoHS & no Sb/Br)	CU NIPDAU	Level-1-260C-UNLIM	-40 to 85	272I	<a href="#">Samples</a>
TLC272IDRG4	ACTIVE	SOIC	D	8	2500	Green (RoHS & no Sb/Br)	CU NIPDAU	Level-1-260C-UNLIM	-40 to 85	272I	<a href="#">Samples</a>
TLC272IP	ACTIVE	PDIP	P	8	50	Green (RoHS & no Sb/Br)	CU NIPDAU	N / A for Pkg Type	-40 to 85	TLC272IP	<a href="#">Samples</a>
TLC272IPE4	ACTIVE	PDIP	P	8	50	Green (RoHS & no Sb/Br)	CU NIPDAU	N / A for Pkg Type	-40 to 85	TLC272IP	<a href="#">Samples</a>
TLC277CD	ACTIVE	SOIC	D	8	75	Green (RoHS & no Sb/Br)	CU NIPDAU	Level-1-260C-UNLIM	0 to 70	277C	<a href="#">Samples</a>
TLC277CDG4	ACTIVE	SOIC	D	8	75	Green (RoHS & no Sb/Br)	CU NIPDAU	Level-1-260C-UNLIM	0 to 70	277C	<a href="#">Samples</a>
TLC277CDR	ACTIVE	SOIC	D	8	2500	Green (RoHS & no Sb/Br)	CU NIPDAU	Level-1-260C-UNLIM	0 to 70	277C	<a href="#">Samples</a>
TLC277CP	ACTIVE	PDIP	P	8	50	Green (RoHS & no Sb/Br)	CU NIPDAU	N / A for Pkg Type	0 to 70	TLC277CP	<a href="#">Samples</a>
TLC277CPSR	ACTIVE	SO	PS	8	2000	Green (RoHS & no Sb/Br)	CU NIPDAU	Level-1-260C-UNLIM	0 to 70	P277	<a href="#">Samples</a>

Orderable Device	Status (1)	Package Type	Package Drawing	Pins	Package Qty	Eco Plan (2)	Lead/Ball Finish (6)	MSL Peak Temp (3)	Op Temp (°C)	Device Marking (4/5)	Samples
TLC277ID	ACTIVE	SOIC	D	8	75	Green (RoHS & no Sb/Br)	CU NIPDAU	Level-1-260C-UNLIM	-40 to 85	277I	<a href="#">Samples</a>
TLC277IDG4	ACTIVE	SOIC	D	8	75	Green (RoHS & no Sb/Br)	CU NIPDAU	Level-1-260C-UNLIM	-40 to 85	277I	<a href="#">Samples</a>
TLC277IDR	ACTIVE	SOIC	D	8	2500	Green (RoHS & no Sb/Br)	CU NIPDAU	Level-1-260C-UNLIM	-40 to 85	277I	<a href="#">Samples</a>
TLC277IP	ACTIVE	PDIP	P	8	50	Green (RoHS & no Sb/Br)	CU NIPDAU	N / A for Pkg Type	-40 to 85	TLC277IP	<a href="#">Samples</a>

(1) The marketing status values are defined as follows:

**ACTIVE:** Product device recommended for new designs.

**LIFEBUY:** TI has announced that the device will be discontinued, and a lifetime-buy period is in effect.

**NRND:** Not recommended for new designs. Device is in production to support existing customers, but TI does not recommend using this part in a new design.

**PREVIEW:** Device has been announced but is not in production. Samples may or may not be available.

**OBSELETE:** TI has discontinued the production of the device.

(2) **RoHS:** TI defines "RoHS" to mean semiconductor products that are compliant with the current EU RoHS requirements for all 10 RoHS substances, including the requirement that RoHS substance do not exceed 0.1% by weight in homogeneous materials. Where designed to be soldered at high temperatures, "RoHS" products are suitable for use in specified lead-free processes. TI may reference these types of products as "Pb-Free".

**RoHS Exempt:** TI defines "RoHS Exempt" to mean products that contain lead but are compliant with EU RoHS pursuant to a specific EU RoHS exemption.

**Green:** TI defines "Green" to mean the content of Chlorine (Cl) and Bromine (Br) based flame retardants meet JS709B low halogen requirements of <=1000ppm threshold. Antimony trioxide based flame retardants must also meet the <=1000ppm threshold requirement.

(3) MSL, Peak Temp. - The Moisture Sensitivity Level rating according to the JEDEC industry standard classifications, and peak solder temperature.

(4) There may be additional marking, which relates to the logo, the lot trace code information, or the environmental category on the device.

(5) Multiple Device Markings will be inside parentheses. Only one Device Marking contained in parentheses and separated by a "~" will appear on a device. If a line is indented then it is a continuation of the previous line and the two combined represent the entire Device Marking for that device.

(6) Lead/Ball Finish - Orderable Devices may have multiple material finish options. Finish options are separated by a vertical ruled line. Lead/Ball Finish values may wrap to two lines if the finish value exceeds the maximum column width.

**Important Information and Disclaimer:**The information provided on this page represents TI's knowledge and belief as of the date that it is provided. TI bases its knowledge and belief on information provided by third parties, and makes no representation or warranty as to the accuracy of such information. Efforts are underway to better integrate information from third parties. TI has taken and continues to take reasonable steps to provide representative and accurate information but may not have conducted destructive testing or chemical analysis on incoming materials and chemicals. TI and TI suppliers consider certain information to be proprietary, and thus CAS numbers and other limited information may not be available for release.

In no event shall TI's liability arising out of such information exceed the total purchase price of the TI part(s) at issue in this document sold by TI to Customer on an annual basis.

**TAPE AND REEL INFORMATION**

**QUADRANT ASSIGNMENTS FOR PIN 1 ORIENTATION IN TAPE**

\*All dimensions are nominal

Device	Package Type	Package Drawing	Pins	SPQ	Reel Diameter (mm)	Reel Width W1 (mm)	A0 (mm)	B0 (mm)	K0 (mm)	P1 (mm)	W (mm)	Pin1 Quadrant
TLC272ACDR	SOIC	D	8	2500	330.0	12.4	6.4	5.2	2.1	8.0	12.0	Q1
TLC272AIDR	SOIC	D	8	2500	330.0	12.4	6.4	5.2	2.1	8.0	12.0	Q1
TLC272BCDR	SOIC	D	8	2500	330.0	12.4	6.4	5.2	2.1	8.0	12.0	Q1
TLC272BIDR	SOIC	D	8	2500	330.0	12.4	6.4	5.2	2.1	8.0	12.0	Q1
TLC272CDR	SOIC	D	8	2500	330.0	12.4	6.4	5.2	2.1	8.0	12.0	Q1
TLC272CPWR	TSSOP	PW	8	2000	330.0	12.4	7.0	3.6	1.6	8.0	12.0	Q1
TLC272IDR	SOIC	D	8	2500	330.0	12.4	6.4	5.2	2.1	8.0	12.0	Q1
TLC277CDR	SOIC	D	8	2500	330.0	12.4	6.4	5.2	2.1	8.0	12.0	Q1
TLC277CPSR	SO	PS	8	2000	330.0	16.4	8.35	6.6	2.5	12.0	16.0	Q1
TLC277IDR	SOIC	D	8	2500	330.0	12.4	6.4	5.2	2.1	8.0	12.0	Q1

**TAPE AND REEL BOX DIMENSIONS**

\*All dimensions are nominal

Device	Package Type	Package Drawing	Pins	SPQ	Length (mm)	Width (mm)	Height (mm)
TLC272ACDR	SOIC	D	8	2500	340.5	338.1	20.6
TLC272AIDR	SOIC	D	8	2500	340.5	338.1	20.6
TLC272BCDR	SOIC	D	8	2500	340.5	338.1	20.6
TLC272BIDR	SOIC	D	8	2500	340.5	338.1	20.6
TLC272CDR	SOIC	D	8	2500	340.5	338.1	20.6
TLC272CPWR	TSSOP	PW	8	2000	367.0	367.0	35.0
TLC272IDR	SOIC	D	8	2500	340.5	338.1	20.6
TLC277CDR	SOIC	D	8	2500	340.5	338.1	20.6
TLC277CPSR	SO	PS	8	2000	367.0	367.0	38.0
TLC277IDR	SOIC	D	8	2500	340.5	338.1	20.6



D0008A

# PACKAGE OUTLINE

SOIC - 1.75 mm max height

SMALL OUTLINE INTEGRATED CIRCUIT



NOTES:

1. Linear dimensions are in inches [millimeters]. Dimensions in parenthesis are for reference only. Controlling dimensions are in inches. Dimensioning and tolerancing per ASME Y14.5M.
2. This drawing is subject to change without notice.
3. This dimension does not include mold flash, protrusions, or gate burrs. Mold flash, protrusions, or gate burrs shall not exceed  $.006$  [0.15] per side.
4. This dimension does not include interlead flash.
5. Reference JEDEC registration MS-012, variation AA.

# EXAMPLE BOARD LAYOUT

D0008A

SOIC - 1.75 mm max height

SMALL OUTLINE INTEGRATED CIRCUIT



LAND PATTERN EXAMPLE  
 EXPOSED METAL SHOWN  
 SCALE:8X



SOLDER MASK DETAILS

4214825/C 02/2019

NOTES: (continued)

- 6. Publication IPC-7351 may have alternate designs.
- 7. Solder mask tolerances between and around signal pads can vary based on board fabrication site.

# EXAMPLE STENCIL DESIGN

D0008A

SOIC - 1.75 mm max height

SMALL OUTLINE INTEGRATED CIRCUIT



SOLDER PASTE EXAMPLE  
BASED ON .005 INCH [0.125 MM] THICK STENCIL  
SCALE:8X

4214825/C 02/2019

NOTES: (continued)

8. Laser cutting apertures with trapezoidal walls and rounded corners may offer better paste release. IPC-7525 may have alternate design recommendations.
9. Board assembly site may have different recommendations for stencil design.

## MECHANICAL DATA

PS (R-PDSO-G8)

PLASTIC SMALL-OUTLINE PACKAGE



- NOTES:
- A. All linear dimensions are in millimeters.
  - B. This drawing is subject to change without notice.
  - C. Body dimensions do not include mold flash or protrusion, not to exceed 0,15.

PS (R-PDSO-G8)

PLASTIC SMALL OUTLINE



- NOTES:
- All linear dimensions are in millimeters.
  - This drawing is subject to change without notice.
  - Publication IPC-7351 is recommended for alternate designs.
  - Laser cutting apertures with trapezoidal walls and also rounding corners will offer better paste release. Customers should contact their board assembly site for stencil design recommendations. Refer to IPC-7525 for other stencil recommendations.
  - Customers should contact their board fabrication site for solder mask tolerances between and around signal pads.

P (R-PDIP-T8)

PLASTIC DUAL-IN-LINE PACKAGE



- NOTES:
- A. All linear dimensions are in inches (millimeters).
  - B. This drawing is subject to change without notice.
  - C. Falls within JEDEC MS-001 variation BA.



# EXAMPLE BOARD LAYOUT

PW0008A

TSSOP - 1.2 mm max height

SMALL OUTLINE PACKAGE

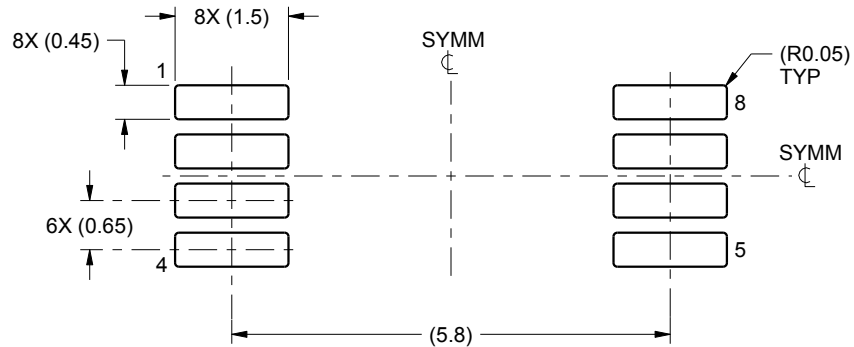

LAND PATTERN EXAMPLE  
SCALE:10X



SOLDER MASK DETAILS  
NOT TO SCALE

4221848/A 02/2015

NOTES: (continued)

- 6. Publication IPC-7351 may have alternate designs.
- 7. Solder mask tolerances between and around signal pads can vary based on board fabrication site.

# EXAMPLE STENCIL DESIGN

PW0008A

TSSOP - 1.2 mm max height

SMALL OUTLINE PACKAGE



SOLDER PASTE EXAMPLE  
BASED ON 0.125 mm THICK STENCIL  
SCALE:10X

4221848/A 02/2015

NOTES: (continued)

8. Laser cutting apertures with trapezoidal walls and rounded corners may offer better paste release. IPC-7525 may have alternate design recommendations.
9. Board assembly site may have different recommendations for stencil design.

## IMPORTANT NOTICE AND DISCLAIMER

TI PROVIDES TECHNICAL AND RELIABILITY DATA (INCLUDING DATASHEETS), DESIGN RESOURCES (INCLUDING REFERENCE DESIGNS), APPLICATION OR OTHER DESIGN ADVICE, WEB TOOLS, SAFETY INFORMATION, AND OTHER RESOURCES "AS IS" AND WITH ALL FAULTS, AND DISCLAIMS ALL WARRANTIES, EXPRESS AND IMPLIED, INCLUDING WITHOUT LIMITATION ANY IMPLIED WARRANTIES OF MERCHANTABILITY, FITNESS FOR A PARTICULAR PURPOSE OR NON-INFRINGEMENT OF THIRD PARTY INTELLECTUAL PROPERTY RIGHTS.

These resources are intended for skilled developers designing with TI products. You are solely responsible for (1) selecting the appropriate TI products for your application, (2) designing, validating and testing your application, and (3) ensuring your application meets applicable standards, and any other safety, security, or other requirements. These resources are subject to change without notice. TI grants you permission to use these resources only for development of an application that uses the TI products described in the resource. Other reproduction and display of these resources is prohibited. No license is granted to any other TI intellectual property right or to any third party intellectual property right. TI disclaims responsibility for, and you will fully indemnify TI and its representatives against, any claims, damages, costs, losses, and liabilities arising out of your use of these resources.

TI's products are provided subject to TI's Terms of Sale ([www.ti.com/legal/termsofsale.html](http://www.ti.com/legal/termsofsale.html)) or other applicable terms available either on [ti.com](http://ti.com) or provided in conjunction with such TI products. TI's provision of these resources does not expand or otherwise alter TI's applicable warranties or warranty disclaimers for TI products.

Mailing Address: Texas Instruments, Post Office Box 655303, Dallas, Texas 75265  
Copyright © 2019, Texas Instruments Incorporated

## Looking for pricing, stock, or lifecycle information?

Click below to explore more details on WIN SOURCE:

 [View TLC272CDRG4 on WIN SOURCE](#)

 [Texas Instruments](#) Information

## Optimize Your Supply Chain with WIN SOURCE Solutions

-  Global Sourcing Solution
-  Obsolete Management
-  Cost Control Management
-  Shortage Management
-  Alternative Solution
-  Excess Inventory Management