

## High-Current Low Dropout Regulators

### Features

- High Current Capability:
  - MIC29150/29151/29152/29153: 1.5A
  - MIC29300/29301/29302/29303: 3A
  - MIC29500/29501/29502/29503: 5A
  - MIC29751/29752: 7.5A
- Low Dropout Voltage
- Low Ground Current
- Accurate 1% Guaranteed Tolerance
- Extremely Fast Transient Response
- Reverse-Battery and “Load Dump” Protection
- Zero-Current Shutdown Mode (5-Pin Versions)
- Error Flag Signals Output Out-of-Regulation (5-Pin Versions)
- Also Characterized for Smaller Loads with Industry-Leading Performance Specifications
- Fixed-Voltage and Adjustable Versions

### Applications

- Battery-Powered Equipment
- High-Efficiency Green Computer Systems
- Automotive Electronics
- High-Efficiency Linear Power Supplies
- High-Efficiency Post-Regulator for Switching Supply

### General Description

The MIC2915x/2930x/2950x/2975x are high current, high accuracy, low dropout voltage regulators. Using Microchip’s proprietary Super  $\beta$  PNP process with a PNP pass element, these regulators feature 350 mV to 425 mV (full load) typical dropout voltages and very low ground current. Designed for high current loads, these devices also find applications in lower current, extremely low dropout-critical systems, where their tiny dropout voltage and ground current values are important attributes.

The MIC2915x/2930x/2950x/2975x are fully protected against overcurrent faults, reversed input polarity, reversed lead insertion, overtemperature operation, and positive and negative transient voltage spikes. Five pin fixed-voltage versions feature logic level ON/OFF control and an error flag that signals whenever the output falls out of regulation. Flagged states include low input voltage (dropout), output current limit, overtemperature shutdown, and extremely high voltage spikes on the input.

On the MIC29xx1 and MIC29xx2, the ENABLE pin may be tied to  $V_{IN}$  if it is not required for ON/OFF control. The MIC2915x/2930x/2950x are available in 3-pin and 5-pin TO-220 and surface mount TO-263 (D<sup>2</sup>Pak) packages. The MIC2975x 7.5A regulators are available in a 5-pin TO-247 package. The 1.5A, adjustable output MIC29152 is available in a 5-pin power D-Pak (TO-252) package.

For applications with input voltage 6V or below, see MIC37xxx LDOs.

### Package Types



# MIC2915X/30X/50X/75X

## Package Types (Continued)

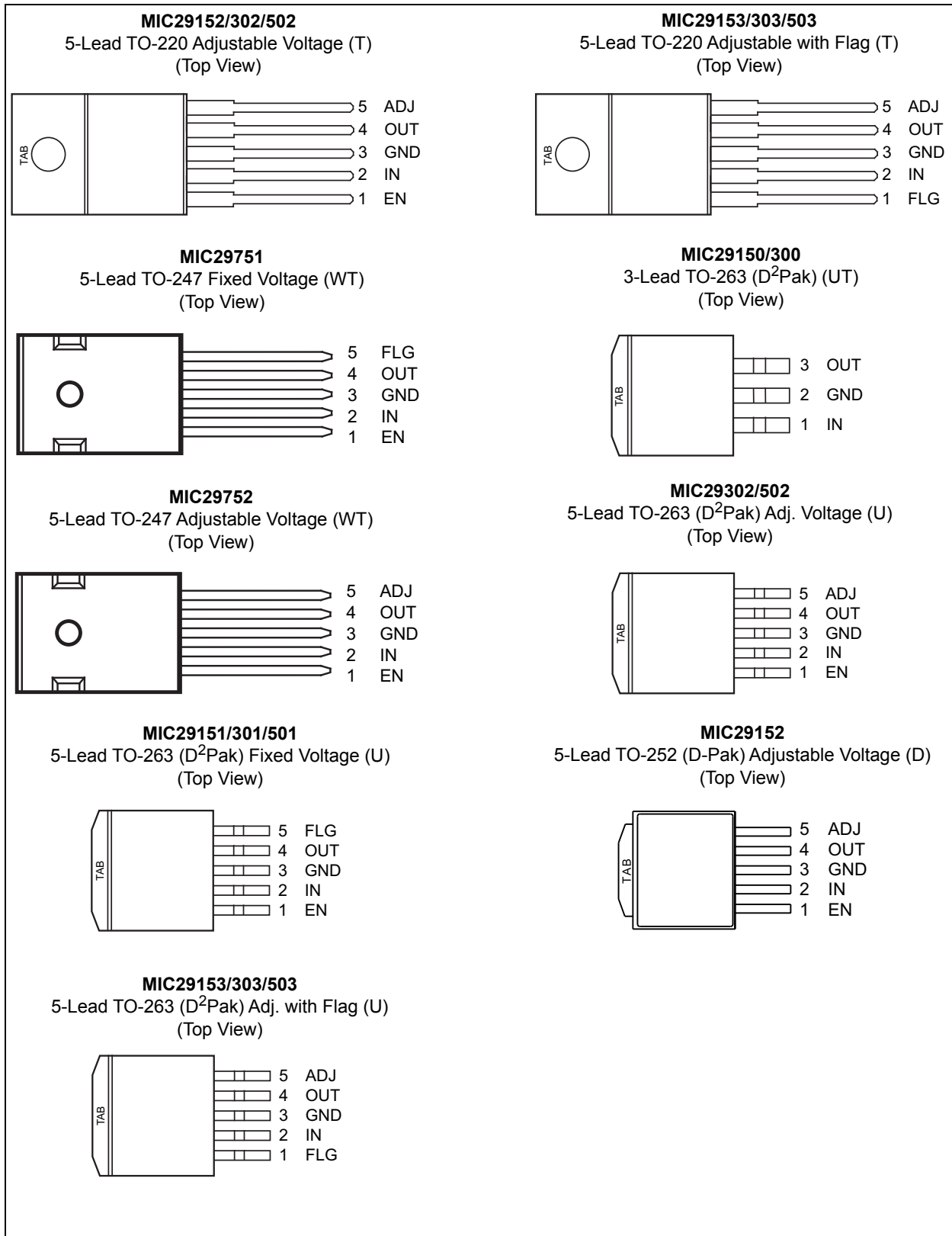

# MIC2915X/30X/50X/75X

## Typical Application Circuits



## Functional Diagram



# MIC2915X/30X/50X/75X

---

## 1.0 ELECTRICAL CHARACTERISTICS

### Absolute Maximum Ratings † (Note 1)

|   |                    |
|---|--------------------|
| Input Supply Voltage ( $V_{IN}$ ) (Note 1)..... | -20V to +60V       |
| Enable Input Voltage ( $V_{EN}$ ) .....         | -0.3V to $V_{IN}$  |
| Power Dissipation.....                          | Internally Limited |
| ESD Rating .....                                | Note 2             |

### Operating Ratings‡

|                                       |      |
|---------------------------------------|------|
| Maximum Operating Input Voltage ..... | +26V |
|---------------------------------------|------|

† **Notice:** Stresses above those listed under “Absolute Maximum Ratings” may cause permanent damage to the device. This is a stress rating only and functional operation of the device at those or any other conditions above those indicated in the operational sections of this specification is not intended. Exposure to maximum rating conditions for extended periods may affect device reliability.

‡ **Notice:** The device is not guaranteed to function outside its operating ratings.

**Note 1:** Maximum positive supply voltage of 60V must be of limited duration (<100 ms) and duty cycle ( $\leq 1\%$ ). The maximum continuous supply voltage is 26V. Exceeding the absolute maximum rating may damage the device.

**2:** Devices are ESD sensitive. Handling precautions recommended.

# MIC2915X/30X/50X/75X

**TABLE 1-1: ELECTRICAL CHARACTERISTICS (Note 1, Note 2)**

**Electrical Characteristics:**  $V_{IN} = V_{OUT} + 1V$ ;  $I_{OUT} = 10\text{ mA}$ ;  $T_J = +25^\circ\text{C}$ . **Bold** values indicate  $-40^\circ\text{C} \leq T_J \leq +125^\circ\text{C}$ , unless noted.

| Parameter   | Symbol       | Min. | Typ.      | Max.        | Units                 | Conditions   |
|---|--------------|------|-----------|-------------|-----------------------|--|
| Output Voltage                                      | $V_{OUT}$    | -1   | —         | 1           | %                     | $I_{OUT} = 10\text{ mA}$   |
|   |              | -2   | —         | 2           |                       | $10\text{ mA} \leq I_{OUT} \leq I_{FL}$ , $(V_{OUT} + 1V) \leq V_{IN} \leq 26V$ (Note 3) |
| Line Regulation                                     |              | —    | 0.06      | 0.5         | %                     | $I_{OUT} = 10\text{ mA}$ , $(V_{OUT} + 1V) \leq V_{IN} \leq 26V$                         |
| Load Regulation                                     |              | —    | 0.2       | 1           | %                     | $V_{IN} = V_{OUT} + 1V$ , $10\text{ mA} \leq I_{OUT} \leq 1.5A$ (Note 3, Note 4)         |
| $\Delta V_O/\Delta T$                               |              | —    | <b>20</b> | <b>100</b>  | ppm/ $^\circ\text{C}$ | Output Voltage (Note 4)<br>Temperature Coefficient                                       |
| Dropout Voltage<br>$\Delta V_{OUT} = -1\%$ (Note 5) |              | —    | 80        | <b>200</b>  | mV                    | MIC2915x $I_{OUT} = 100\text{ mA}$   |
|   |              | —    | 220       | —           |                       | MIC2915x $I_{OUT} = 750\text{ mA}$   |
|   |              | —    | 350       | <b>600</b>  |                       | MIC2915x $I_{OUT} = 1.5A$  |
|   |              | —    | 80        | <b>175</b>  |                       | MIC2930x $I_{OUT} = 100\text{ mA}$   |
|   |              | —    | 250       | —           |                       | MIC2930x $I_{OUT} = 1.5A$  |
|   |              | —    | 370       | <b>600</b>  |                       | MIC2930x $I_{OUT} = 3A$  |
|   |              | —    | 125       | <b>250</b>  |                       | MIC2950x $I_{OUT} = 250\text{ mA}$   |
|   |              | —    | 250       | —           |                       | MIC2950x $I_{OUT} = 2.5A$  |
|   |              | —    | 370       | <b>600</b>  |                       | MIC2950x $I_{OUT} = 5A$  |
|   |              | —    | 80        | <b>200</b>  |                       | MIC2975x $I_{OUT} = 250\text{ mA}$   |
|   |              | —    | 270       | —           |                       | MIC2975x $I_{OUT} = 4A$  |
|   |              | —    | 425       | 750         |                       | MIC2975x $I_{OUT} = 7.5A$  |
| Ground Current (Note 6)                             | $I_{GND}$    | —    | 8         | <b>20</b>   | mA                    | MIC2915x $I_{OUT} = 750\text{ mA}$ ,<br>$V_{IN} = V_{OUT} + 1V$                          |
|   |              | —    | 22        | —           |                       | MIC2915x $I_{OUT} = 1.5A$  |
|   |              | —    | 10        | <b>35</b>   |                       | MIC2930x $I_{OUT} = 1.5A$ ,<br>$V_{IN} = V_{OUT} + 1V$                                   |
|   |              | —    | 37        | —           |                       | MIC2930x $I_{OUT} = 3A$  |
|   |              | —    | 15        | <b>50</b>   |                       | MIC2950x $I_{OUT} = 2.5A$ ,<br>$V_{IN} = V_{OUT} + 1V$                                   |
|   |              | —    | 70        | —           |                       | MIC2950x $I_{OUT} = 5A$  |
|   |              | —    | 35        | <b>75</b>   |                       | MIC2975x $I_{OUT} = 4A$ ,<br>$V_{IN} = V_{OUT} + 1V$                                     |
|   |              | —    | 120       | —           |                       | MIC2975x $I_{OUT} = 7.5A$  |
| Ground Pin Current at Dropout                       | $I_{GRNDDO}$ | —    | 0.9       | —           | mA                    | MIC2915x, $V_{IN} = 0.5V$ less than specified $V_{OUT} \times I_{OUT} = 10\text{ mA}$    |
|   |              | —    | 1.7       | —           |                       | MIC2930x, $V_{IN} = 0.5V$ less than specified $V_{OUT} \times I_{OUT} = 10\text{ mA}$    |
|   |              | —    | 2.1       | —           |                       | MIC2950x, $V_{IN} = 0.5V$ less than specified $V_{OUT} \times I_{OUT} = 10\text{ mA}$    |
|   |              | —    | 3.1       | —           |                       | MIC2975x, $V_{IN} = 0.5V$ less than specified $V_{OUT} \times I_{OUT} = 10\text{ mA}$    |
| Current Limit                                       | $I_{LIM}$    | —    | 2.1       | <b>3.5</b>  | A                     | MIC2915x, $V_{OUT} = 0V$ , (Note 7)  |
|   |              | —    | 4.5       | <b>5.0</b>  |                       | MIC2930x, $V_{OUT} = 0V$ , (Note 7)  |
|   |              | —    | 7.5       | <b>10.0</b> |                       | MIC2950x, $V_{OUT} = 0V$ , (Note 7)  |
|   |              | —    | 9.5       | <b>15.0</b> |                       | MIC2975x, $V_{OUT} = 0V$ , (Note 7)  |

# MIC2915X/30X/50X/75X

**TABLE 1-1: ELECTRICAL CHARACTERISTICS (Note 1, Note 2) (CONTINUED)**

**Electrical Characteristics:**  $V_{IN} = V_{OUT} + 1V$ ;  $I_{OUT} = 10\text{ mA}$ ;  $T_J = +25^\circ\text{C}$ . **Bold** values indicate  $-40^\circ\text{C} \leq T_J \leq +125^\circ\text{C}$ , unless noted.

| Parameter  | Symbol          | Min.         | Typ.  | Max.         | Units                      | Conditions   |
|--|-----------------|--------------|-------|--------------|----------------------------|--|
| $e_n$ , Output Noise Voltage (10 Hz to 100 kHz)<br>$I_L = 100\text{ mA}$ |                 | —            | 400   | —            | $\mu\text{V}_{\text{RMS}}$ | $C_L = 10\text{ }\mu\text{F}$  |
|  |                 | —            | 260   | —            |                            | $C_L = 33\text{ }\mu\text{F}$  |
| Ground Current in Shutdown   |                 | —            | 2     | 10           | $\mu\text{A}$              | MIC29150/1/2/3 only  |
|  |                 | —            | —     | <b>30</b>    |                            | $V_{\text{EN}} = 0.4\text{V}$  |
| <b>Reference - MIC29xx2/MIC29xx3</b>                                     |                 |              |       |              |                            |  |
| Reference Voltage  |                 | 1.228        | 1.240 | 1.252        | V                          | —  |
|  |                 | <b>1.215</b> | —     | <b>1.265</b> | $V_{\text{MAX}}$           |  |
| Reference Voltage  |                 | <b>1.203</b> | —     | <b>1.277</b> | V                          | Note 8   |
| Adjust Pin Bias Current  |                 | —            | 40    | 80           | nA                         | —  |
|  |                 | —            | —     | <b>120</b>   |                            |  |
| Reference Voltage Temperature Coefficient                                |                 | —            | 20    | —            | ppm/°C                     | Note 9   |
| Adjust Pin Bias Current Temperature Coefficient                          |                 | —            | 0.1   | —            | nA/°C                      | —  |
| <b>Flag Output (Error Comparator) - MIC29xx1/29xx3</b>                   |                 |              |       |              |                            |  |
| Output Leakage Current   |                 | —            | 0.01  | 1.00         | $\mu\text{A}$              | $V_{\text{OH}} = 26\text{V}$   |
|  |                 | —            | —     | <b>2.00</b>  |                            |  |
| Output Low Voltage   | $V_{\text{OL}}$ | —            | 220   | 300          | mV                         | Device set for 5V, $V_{\text{IN}} = 4.5\text{V}$<br>$I_{\text{OL}} = 250\text{ }\mu\text{A}$ |
|  |                 | —            | —     | <b>400</b>   |                            |  |
| Upper Threshold Voltage  |                 | 40           | 60    | —            | mV                         | Device set for 5V, (Note 10)   |
|  |                 | 25           | —     | —            |                            |  |
| Lower Threshold Voltage  |                 | —            | 75    | 95           | mV                         | Device set for 5V, (Note 10)   |
|  |                 | —            | —     | <b>140</b>   |                            |  |
| Hysteresis   |                 | —            | 15    | —            | mV                         | Device set for 5V, (Note 10)   |

# MIC2915X/30X/50X/75X

**TABLE 1-1: ELECTRICAL CHARACTERISTICS (Note 1, Note 2) (CONTINUED)**

**Electrical Characteristics:**  $V_{IN} = V_{OUT} + 1V$ ;  $I_{OUT} = 10\text{ mA}$ ;  $T_J = +25^\circ\text{C}$ . **Bold** values indicate  $-40^\circ\text{C} \leq T_J \leq +125^\circ\text{C}$ , unless noted.

| Parameter                               | Symbol | Min. | Typ. | Max.       | Units         | Conditions   |
|---|--------|------|------|------------|---------------|--|
| <b>ENABLE Input - MIC29xx1/MIC29xx2</b> |        |      |      |            |               |  |
| Input Logic Voltage Low (OFF)           |        | —    | —    | 0.8        | V             | —  |
| Input Logic Voltage High (ON)           |        | 2.4  | —    | —          | V             | —  |
| Enable Pin Input Current                |        | —    | 100  | 600        | $\mu\text{A}$ | $V_{EN} = 26V$   |
|   |        | —    | —    | <b>750</b> |               |  |
|   |        | 0.7  | —    | 2          |               | $V_{EN} = 0.8V$  |
|   |        | —    | —    | <b>4</b>   |               |  |
| Regulator Output Current in Shutdown    |        | —    | 10   | <b>500</b> | $\mu\text{A}$ | $V_{EN} \leq 0.8V$ and $V_{IN} \leq 26V$ , $V_{OUT} = 0$ . |

**Note 1:** Specification for packaged product only.

- 2:** When used in dual supply systems where the regulator load is returned to a negative supply, the output voltage must be diode clamped to ground.
- 3:** Full load current ( $I_{FL}$ ) is defined as 1.5A for the MIC2915x, 3A for the MIC2930x, 5A for the MIC2950x, and 7.5A for the MIC2975x families.
- 4:** Output voltage temperature coefficient is defined as the worst case voltage change divided by the total temperature range.
- 5:** Dropout voltage is defined as the input-to-output differential when the output voltage drops to 99% of its normal value with  $V_{OUT} + 1V$  applied to  $V_{IN}$ .
- 6:** Ground pin current is the regulator quiescent current. The total current drawn from the source is the sum of the load current plus the ground pin current.
- 7:**  $V_{IN} = V_{OUT} (\text{nominal}) + 1V$ . For example, use  $V_{IN} = 4.3V$  for a 3.3V regulator or use 6V for a 5V regulator. Employ pulse-testing procedures to pin current.
- 8:**  $V_{REF} \leq V_{OUT} \leq (V_{IN} - 1V)$ ,  $2.3V \leq V_{IN} \leq 26V$ ,  $10\text{ mA} < I_L \leq I_{FL}$ ,  $T_J \leq T_{JMAX}$ .
- 9:** Thermal regulation is defined as the change in output voltage at a time T after a change in power dissipation is applied, excluding load or line regulation effects. Specifications are for a 200 mA load pulse at  $V_{IN} = 20V$  (a 4W pulse) for  $T = 10\text{ ms}$ .
- 10:** Comparator thresholds are expressed in terms of a voltage differential at the adjust terminal below the nominal reference voltage measured at 6V input. To express these thresholds in terms of output voltage change, multiply by the error amplifier gain =  $V_{OUT}/V_{REF} = (R1 + R2)/R2$ . For example, at a programmed output voltage of 5V, the error output is guaranteed to go low when the output drops by  $95\text{ mV} \times 5V/1.240V = 384\text{ mV}$ . Thresholds remain constant as a percent of  $V_{OUT}$  as  $V_{OUT}$  is varied, with the dropout warning occurring at typically 5% below nominal, 7.7% guaranteed.

# MIC2915X/30X/50X/75X

## TEMPERATURE SPECIFICATIONS (Note 1)

| Parameters                        | Sym.          | Min. | Typ. | Max. | Units | Conditions        |
|-----------------------------------|---------------|------|------|------|-------|-------------------|
| <b>Temperature Ranges</b>         |               |      |      |      |       |                   |
| Storage Temperature Range         | $T_S$         | -65  | —    | +150 | °C    | —                 |
| Operating Junction Temperature    | $T_J$         | -40  | —    | +125 | °C    | —                 |
| Lead Temperature                  | —             | —    | —    | +260 | °C    | Soldering, 5 sec. |
| <b>Package Thermal Resistance</b> |               |      |      |      |       |                   |
| Thermal Resistance TO-220         | $\theta_{JC}$ | —    | 2    | —    | °C/W  | —                 |
| Thermal Resistance TO-263         | $\theta_{JC}$ | —    | 2    | —    | °C/W  | —                 |
| Thermal Resistance TO-247         | $\theta_{JC}$ | —    | 1.5  | —    | °C/W  | —                 |
| Thermal Resistance TO-252         | $\theta_{JC}$ | —    | 3    | —    | °C/W  | —                 |
| Thermal Resistance TO-252         | $\theta_{JA}$ | —    | 56   | —    | °C/W  | —                 |

**Note 1:** The maximum allowable power dissipation is a function of ambient temperature, the maximum allowable junction temperature and the thermal resistance from junction to air (i.e.,  $T_A$ ,  $T_J$ ,  $\theta_{JA}$ ). Exceeding the maximum allowable power dissipation will cause the device operating junction temperature to exceed the maximum +125°C rating. Sustained junction temperatures above +125°C can impact the device reliability.

## 2.0 TYPICAL PERFORMANCE CURVES

**Note:** The graphs and tables provided following this note are a statistical summary based on a limited number of samples and are provided for informational purposes only. The performance characteristics listed herein are not tested or guaranteed. In some graphs or tables, the data presented may be outside the specified operating range (e.g., outside specified power supply range) and therefore outside the warranted range.

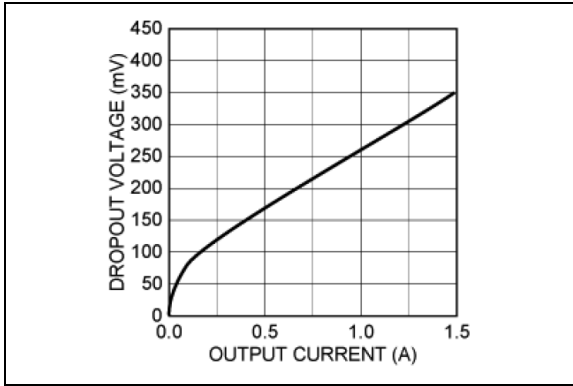

**FIGURE 2-1:** MIC2915x Dropout Voltage vs. Output Current.

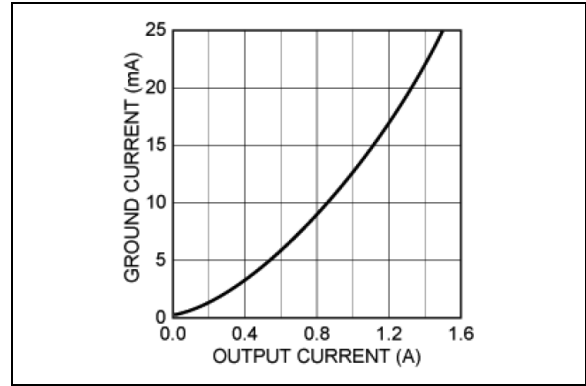

**FIGURE 2-4:** MIC2915x Ground Current vs. Output Current.

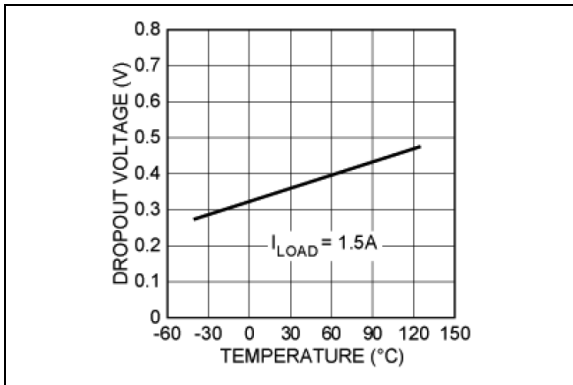

**FIGURE 2-2:** MIC2915x Dropout Voltage vs. Temperature.

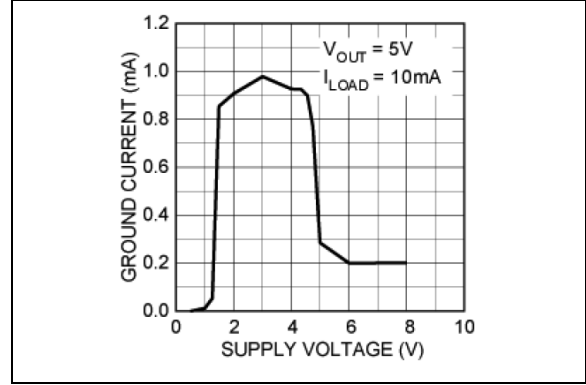

**FIGURE 2-5:** MIC2915x Ground Current vs. Supply Voltage.

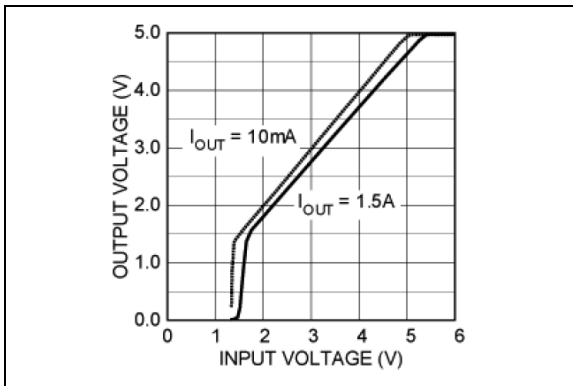

**FIGURE 2-3:** MIC29150-5.0 Dropout Characteristics.

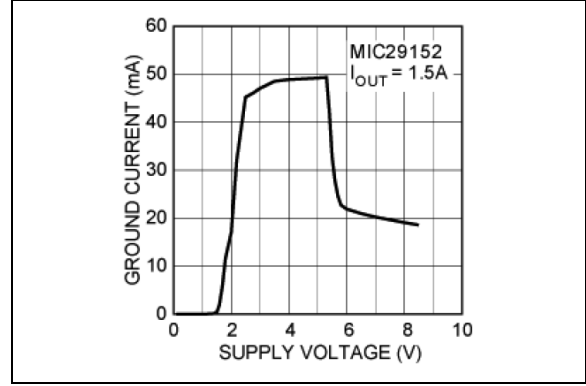

**FIGURE 2-6:** MIC2915x Ground Current vs. Supply Voltage.

# MIC2915X/30X/50X/75X



**FIGURE 2-7:** MIC2915x Ground Current vs. Temperature.



**FIGURE 2-10:** MIC29150-3.3 Output Voltage vs. Temperature.



**FIGURE 2-8:** MIC2915x Ground Current vs. Temperature.



**FIGURE 2-11:** MIC29150-3.3 Short-Circuit Current vs. Temperature.



**FIGURE 2-9:** MIC2915x Ground Current vs. Temperature.

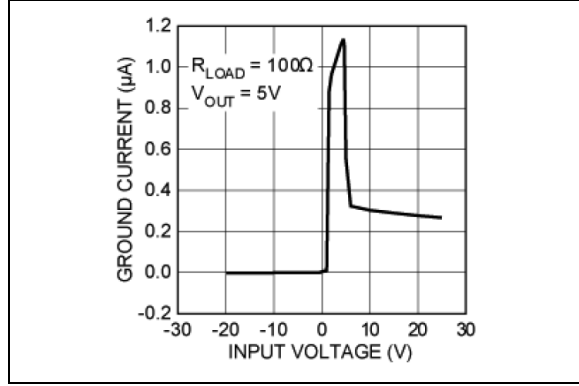

**FIGURE 2-12:** MIC2915x Ground Current vs. Input Voltage.



**FIGURE 2-13:** MIC29151-xx/2 Enable Current vs. Temperature.



**FIGURE 2-16:** MIC29152/3 Adjust Pin Current vs. Temperature.



**FIGURE 2-14:** MIC2915x Load Transient.



**FIGURE 2-17:** MIC2915x Line Transient.



**FIGURE 2-15:** MIC2915x Load Transient.



**FIGURE 2-18:** MIC2915x Line Transient.

# MIC2915X/30X/50X/75X



**FIGURE 2-19:** MIC2915x Output Impedance vs. Frequency.



**FIGURE 2-22:** MIC2930x Dropout Voltage vs. Output Current.



**FIGURE 2-20:** MIC29152 Ground Current vs. Temperature.



**FIGURE 2-23:** MIC2930x Dropout Voltage vs. Temperature.



**FIGURE 2-21:** MIC29152 Dropout Voltage vs. Output Current.



**FIGURE 2-24:** MIC29300-3.3 Dropout Characteristics.



**FIGURE 2-25:** MIC2930x Ground Current vs. Output Current.



**FIGURE 2-28:** MIC2930x Ground Current vs. Temperature.

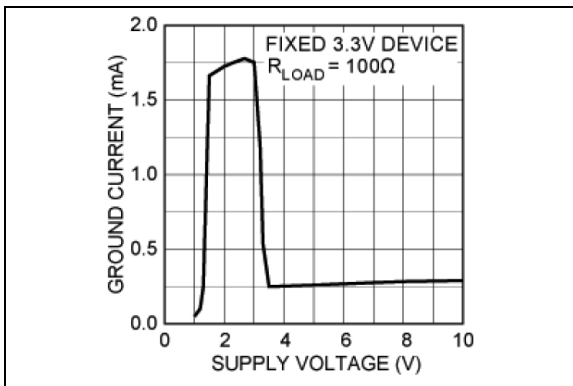

**FIGURE 2-26:** MIC2930x Ground Current vs. Supply Voltage.

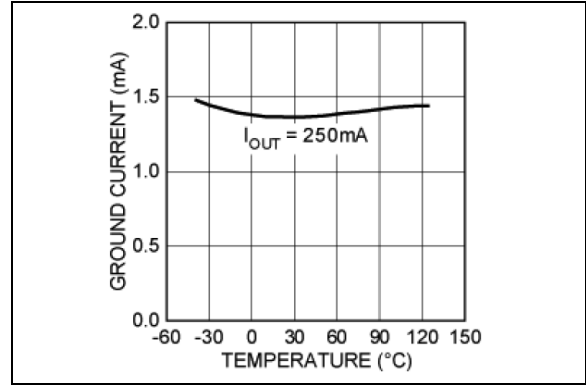

**FIGURE 2-29:** MIC2930x Ground Current vs. Temperature.



**FIGURE 2-27:** MIC2930x Ground Current vs. Supply Voltage.



**FIGURE 2-30:** MIC2930x Ground Current vs. Temperature.

# MIC2915X/30X/50X/75X



**FIGURE 2-31:** MIC29300-3.3 Output Voltage vs. Temperature.



**FIGURE 2-34:** MIC29301-xx/2 Enable Current vs. Temperature.



**FIGURE 2-32:** MIC29300-5.0 Short-Circuit Current vs. Temperature.



**FIGURE 2-35:** MIC2930x Load Transient.



**FIGURE 2-33:** MIC2930x Ground Current vs. Input Voltage.

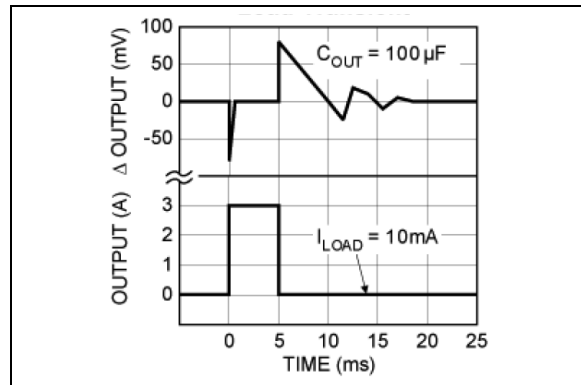

**FIGURE 2-36:** MIC2930x Load Transient.



**FIGURE 2-37:** MIC29302/3 Adjust Pin Current vs. Temperature.



**FIGURE 2-40:** MIC2930x Output Impedance vs. Frequency.



**FIGURE 2-38:** MIC2930x Line Transient.



**FIGURE 2-41:** MIC2930x  $I_{OUT}$  vs.  $V_{IN} - V_{OUT}$  SOA (TO-263).



**FIGURE 2-39:** MIC2930x Line Transient.



**FIGURE 2-42:** MIC2930x  $I_{OUT}$  vs.  $T_A$  SOA (TO-263).

# MIC2915X/30X/50X/75X



**FIGURE 2-43:** MIC2930x Short-Circuit SOA vs. Temperature (TO-263).



**FIGURE 2-46:** MIC29500-3.3 Dropout Characteristics.



**FIGURE 2-44:** MIC2950x Dropout Voltage vs. Output Current.



**FIGURE 2-47:** MIC2950x Ground Current vs. Output Current.



**FIGURE 2-45:** MIC2950x Dropout Voltage vs. Temperature.



**FIGURE 2-48:** MIC2950x Ground Current vs. Supply Voltage.



**FIGURE 2-49:** MIC2950x Ground Current vs. Supply Voltage.



**FIGURE 2-52:** MIC2950x Ground Current vs. Temperature.



**FIGURE 2-50:** MIC2950x Ground Current vs. Temperature.

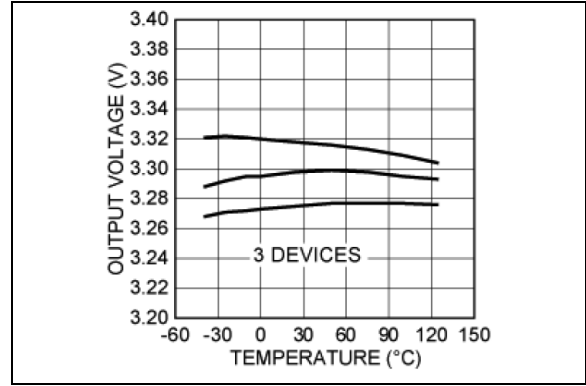

**FIGURE 2-53:** MIC29500-3.3 Output Voltage vs. Temperature.



**FIGURE 2-51:** MIC2950x Ground Current vs. Temperature.

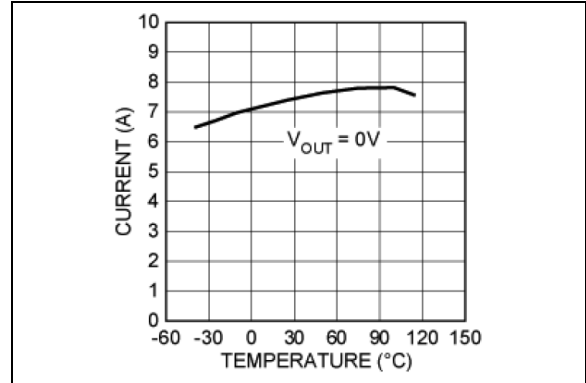

**FIGURE 2-54:** MIC2950x-5.0 Short-Circuit Current vs. Temperature.

# MIC2915X/30X/50X/75X



**FIGURE 2-55:** MIC2950x Ground Current vs. Input Voltage.



**FIGURE 2-58:** MIC2950x Load Transient.



**FIGURE 2-56:** MIC29501-xx/2 Enable Current vs. Temperature.



**FIGURE 2-59:** MIC29502/3 Adjust Pin Current vs. Temperature.



**FIGURE 2-57:** MIC2950x Load Transient.



**FIGURE 2-60:** MIC2950x Line Transient.



**FIGURE 2-61:** MIC2950x Line Transient.



**FIGURE 2-64:** MIC2975x Dropout Voltage vs. Temperature.



**FIGURE 2-62:** MIC2950x Output Impedance vs. Frequency.



**FIGURE 2-65:** MIC29751-3.3 Dropout Characteristics.



**FIGURE 2-63:** MIC2975x Dropout Voltage vs. Output Current.



**FIGURE 2-66:** MIC2975x Ground Current vs. Output Current.

# MIC2915X/30X/50X/75X



**FIGURE 2-67:** MIC2975x Ground Current vs. Supply Voltage.



**FIGURE 2-70:** MIC2975x Ground Current vs. Temperature.



**FIGURE 2-68:** MIC2975x Ground Current vs. Supply Voltage.



**FIGURE 2-71:** MIC2975x Ground Current vs. Temperature.



**FIGURE 2-69:** MIC2975x Ground Current vs. Temperature.



**FIGURE 2-72:** MIC29751-3.3 Output Voltage vs. Temperature.

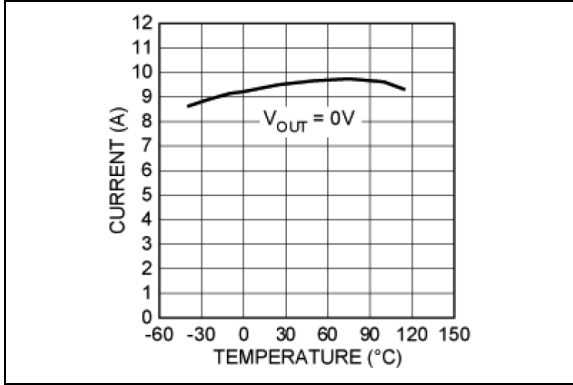

**FIGURE 2-73:** MIC29751-5.0 Short-Circuit Current vs. Temperature.

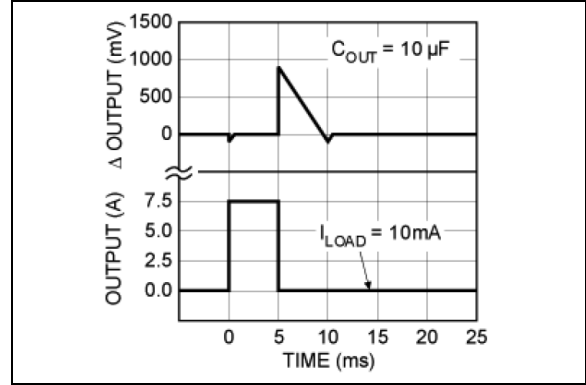

**FIGURE 2-76:** MIC2975x Load Transient.

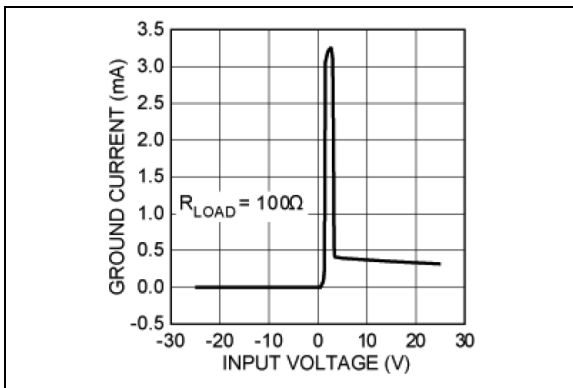

**FIGURE 2-74:** MIC2975x Ground Current vs. Input Voltage.

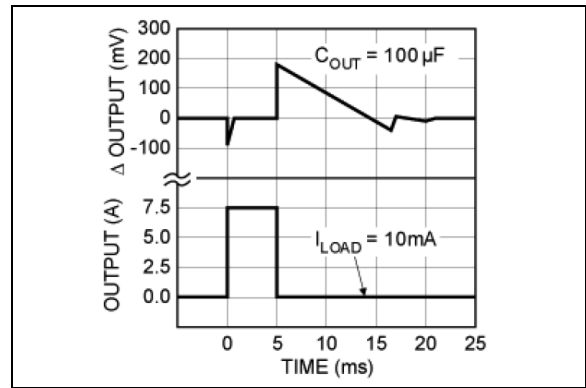

**FIGURE 2-77:** MIC2975x Load Transient.

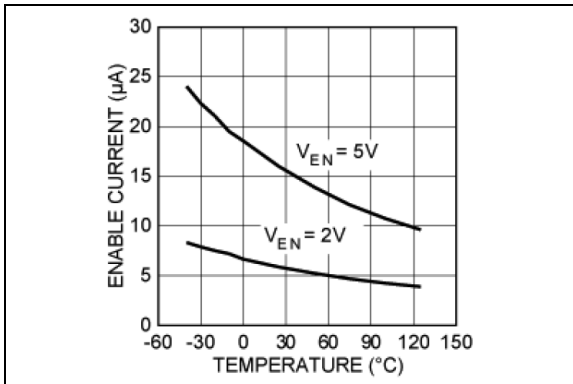

**FIGURE 2-75:** MIC29751-xx/2 Enable Current vs. Temperature.

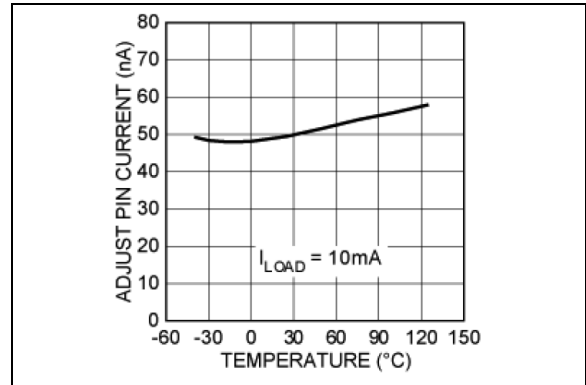

**FIGURE 2-78:** MIC29752 Adjust Pin Current vs. Temperature.

# MIC2915X/30X/50X/75X



**FIGURE 2-79:** MIC2975x Line Transient.



**FIGURE 2-80:** MIC2975x Line Transient.

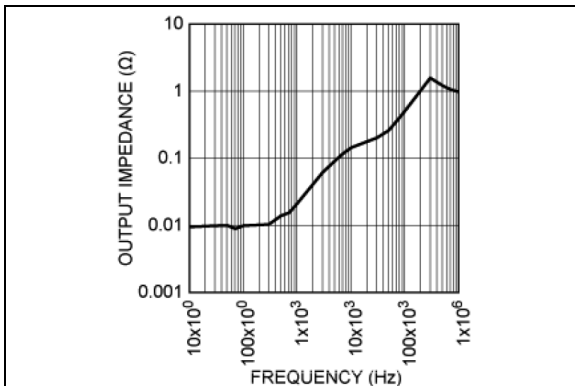

**FIGURE 2-81:** MIC2975x Output Impedance vs. Frequency.

## 3.0 PIN DESCRIPTIONS

The descriptions of the pins are listed in [Table 3-1](#) and [Table 3-2](#).

**TABLE 3-1: PIN FUNCTION TABLE**

| Pin Number<br>TO-220<br>TO-263 | Pin Name | Description   |
|--------------------------------|----------|---|
| 1                              | INPUT    | Supplies the current to the output power device.              |
| 2                              | GND      | TAB is also connected internally to the IC's ground on D-PAK. |
| 3                              | OUTPUT   | The regulator output voltage.                                 |

**TABLE 3-2: PIN FUNCTION TABLE**

| Pin Number<br>Fixed<br>TO-220<br>TO-247<br>TO-263 | Pin Number<br>Adjustable<br>TO-220<br>TO-247<br>TO-252<br>TO-263 | Pin Number<br>Adj. w/ Flag<br>TO-220<br>TO-247<br>TO-263 | Pin Name | Description   |
|---|--|--|----------|---|
| 1   | 1  | —  | ENABLE   | CMOS compatible control input. Logic-high = enable, logic-low = shutdown.   |
| 2   | 2  | 2  | INPUT    | Supplies the current to the output power device.  |
| 3, TAB  | 3, TAB   | 3, TAB   | GND      | TAB is also connected internally to the IC's ground on D-PAK.   |
| 4   | 4  | 4  | OUTPUT   | The regulator output voltage.   |
| —   | 5  | 5  | ADJUST   | Adjustable regulator feedback input that connects to the resistor voltage divider that is placed from OUTPUT to GND in order to set the output voltage. |
| 5   | —  | 1  | FLAG     | Active-low error flag output signal that indicates an output fault condition.   |

# MIC2915X/30X/50X/75X

## 4.0 APPLICATION INFORMATION

The MIC2915x, MIC2930x, MIC2950x, and MIC2975x are high-performance low-dropout voltage regulators suitable for all moderate to high-current voltage regulator applications. Their 350 mV to 425 mV typical dropout voltage at full load make them especially valuable in battery powered systems and as high efficiency noise filters in post-regulator applications. Unlike older NPN-pass transistor designs, where the minimum dropout voltage is limited by the base-emitter voltage drop and collector-emitter saturation voltage, dropout performance of the PNP output of these devices is limited merely by the low VCE saturation voltage.

A trade-off for the low-dropout voltage is a varying base driver requirement. But Microchip's Super  $\beta$  PNP process reduces this drive requirement to merely 1% of the load current.

The MIC2915x/2930x/2950x/2975x family of regulators are fully protected from damage due to fault conditions. Current limiting is provided. This limiting is linear; output current under overload conditions is constant. Thermal shutdown disables the device when the die temperature exceeds the +125°C maximum safe operating temperature. Line transient protection allows device and load survival even when the input voltage spikes between -20V and +60V. When the input voltage exceeds approximately 32V, the overvoltage sensor disables the regulator. The output structure of these regulators allows voltages in excess of the desired output voltage to be applied without reverse current flow. MIC29xx1 and MIC29xx2 versions offer a logic-level ON/OFF control. When disabled, the devices draw nearly zero current.

An additional feature of this regulator family is a common pinout. A design's current requirement may change up or down, but use the same board layout because all of these regulators have identical pinouts.



**FIGURE 4-1:** Linear Regulators Require Only Two Capacitors for Operation.

## 4.1 Thermal Design

Linear regulators are simple to use. The most complicated design parameters to consider are thermal characteristics. Thermal design requires the following application-specific parameters:

- Maximum Ambient Temperature,  $T_A$
- Output Current,  $I_{OUT}$
- Output Voltage,  $V_{OUT}$
- Input Voltage,  $V_{IN}$

First, calculate the power dissipation of the regulator from these numbers and the device parameters from this data sheet.

### EQUATION 4-1:

$$P_D = I_{OUT}(1.01(V_{IN} - V_{OUT}))$$

The ground current is approximated by 1% of  $I_{OUT}$ . Then the heat sink thermal resistance is determined with [Equation 4-2](#).

### EQUATION 4-2:

$$\theta_{SA} = \frac{T_{JMAX} - T_A}{P_D} - (\theta_{JC} + \theta_{CS})$$

Where:

$$T_{JMAX} \leq 125^\circ\text{C}$$

$$\theta_{CS} \text{ Between } 0^\circ\text{C/W and } 2^\circ\text{C/W}$$

The heat sink may be significantly reduced in applications where the minimum input voltage is known and is large compared with the dropout voltage. Use a series input resistor to drop excessive voltage and distribute the heat between this resistor and the regulator. The low-dropout properties of Super  $\beta$  PNP regulators allow very significant reductions in regulator power dissipation and the associated heat sink without compromising performance. When this technique is employed, a capacitor of at least 0.1  $\mu\text{F}$  is needed directly between the input and regulator ground.

Please refer to [Application Note 9](#) and [Application Hint 17](#) for further details and examples on thermal design and heat sink specification.

With no heat sink in the application, calculate the junction temperature to determine the maximum power dissipation that will be allowed before exceeding the maximum junction temperature of the MIC29152. The maximum power allowed can be calculated using the

thermal resistance ( $\theta_{JA}$ ) of the D-Pak adhering to the following criteria for the PCB design: 2 oz. copper and 100 mm<sup>2</sup> copper area for the MIC29152.

For example, given an expected maximum ambient temperature ( $T_A$ ) of +75°C with  $V_{IN} = 3.3V$ ,  $V_{OUT} = 2.5V$ , and  $I_{OUT} = 1.5A$ , first calculate the expected  $P_D$  using [Equation 4-3](#):

**EQUATION 4-3:**

$$P_D = (3.3V - 2.5V) \times 1.5A - (3.3V \times 0.016A) = 1.1472W$$

Next, calculate the junction temperature for the expected power dissipation.

**EQUATION 4-4:**

$$T_J = (\theta_{JA} \times P_D) + T_A = (56^\circ C/W \times 1.1472W) + 75^\circ C = 139.24^\circ C$$

Now determine the maximum power dissipation allowed that would not exceed the IC's maximum junction temperature (+125°C) without the use of a heat sink.

**EQUATION 4-5:**

$$P_{D(MAX)} = (T_{J(MAX)} - T_A) \div \theta_{JA} = (125^\circ C - 75^\circ C) \div 56^\circ C/W = 0.893W$$

## 4.2 Capacitor Requirements

For stability and minimum output noise, a capacitor on the regulator output is necessary. The value of this capacitor is dependent upon the output current; lower currents allow smaller capacitors. The MIC2915x/2930x/2950x/2975x regulators are stable with the following minimum capacitor values at full load, as noted in [Table 4-1](#).

**TABLE 4-1: MINIMUM CAPACITOR VALUES AT FULL LOAD**

| Device   | Full-Load Capacitor |
|----------|---------------------|
| MIC2915x | 10 $\mu$ F          |
| MIC2930x | 10 $\mu$ F          |
| MIC2950x | 10 $\mu$ F          |
| MIC2975x | 22 $\mu$ F          |

This capacitor need not be an expensive low ESR type: aluminum electrolytics are adequate. In fact, extremely low ESR capacitors may contribute to instability. Tantalum capacitors are recommended for systems where fast load transient response is important.

Where the regulator is powered from a source with high AC impedance, a 0.1  $\mu$ F capacitor connected between Input and GND is recommended. This capacitor should have good characteristics to above 250 kHz.

## 4.3 Minimum Load Current

The MIC2915x–2975x regulators are specified between finite loads. If the output current is too small, leakage currents dominate and the output voltage rises. The following minimum load current swamps any expected leakage current across the operating temperature range, as shown in [Table 4-2](#).

**TABLE 4-2: MINIMUM LOAD CURRENTS**

| Device   | Minimum Load |
|----------|--------------|
| MIC2915x | 5 mA         |
| MIC2930x | 7 mA         |
| MIC2950x | 10 mA        |
| MIC2975x | 10 mA        |

## 4.4 Adjustable Regulator Design

The adjustable regulator versions, MIC29xx2 and MIC29xx3, allow programming the output voltage anywhere between 1.25V and the 25V. Two resistors are used. The resistor values are calculated by [Equation 4-6](#).

**EQUATION 4-6:**

$$R1 = R2 \times \left( \frac{V_{OUT}}{1.240} - 1 \right)$$

In the equation above,  $V_{OUT}$  is the desired output voltage. [Figure 4-2](#) shows component definition. Applications with widely varying load currents may scale the resistors to draw the minimum load current required for proper operation (see the [Minimum Load Current](#) sub-section).

# MIC2915X/30X/50X/75X



**FIGURE 4-2:** Adjustable Regulator with Resistors.

## 4.5 Error Flag

MIC29xx1 and MIC29xx3 versions feature an Error Flag, which looks at the output voltage and signals an error condition when this voltage drops 5% below its expected value. The error flag is an open-collector output that pulls low under fault conditions. It may sink 10 mA. Low output voltage signifies a number of possible problems, including an overcurrent fault (the device is in current-limit) and low input voltage. The flag output is inoperative during overtemperature shutdown conditions.

## 4.6 Enable Input

MIC29xx1 and MIC29xx2 versions feature an enable (EN) input that allows ON/OFF control of the device. Special design allows “zero” current drain when the device is disabled; only microamperes of leakage current flows. The EN input has TTL/CMOS compatible thresholds for simple interfacing with logic, or may be directly tied to  $\leq 30V$ . Enabling the regulator requires approximately 20  $\mu A$  of current.

## 5.0 PACKAGING INFORMATION

### 5.1 Package Marking Information

3- and 5-Pin TO-263 (Fixed)\*

XXXXXXXXX  
X.XXX  
WNNNP

Example

MIC29150  
3.3WU  
8943P

5-Pin TO-263 (Adjustable)\*

XXX  
XXXXXXXXX  
WNNNP

Example

MIC  
29152WU  
6235P

3- and 5-Pin TO-220 (Fixed)\*

XXXXX  
X.XXX  
WNNNP

Example

29301  
5.0WT  
1586P

5-Pin TO-220 (Adjustable)\*

XXX  
XXXXXXXXX  
WNNNP

Example

MIC  
29302WT  
7404P

# MIC2915X/30X/50X/75X

5-Pin TO-252\*

```

mXXX
XXXXXXXX
WNNNP<BS1><COO>
    
```

Example

```

mMIC
29152WD
3102P USA
    
```

5-Pin TO-247 (Fixed)\*

```

mXXXXX
XXXXXXXXX-X.XXXX
WNNNP
<COO>
YYWWNNN
    
```

Example

```

mMICREL
MIC29751-3.3WWT
5943P
USA
1642815
    
```

5-Pin TO-247 (Adjustable)\*

```

mXXXXX
XXXXXXXXXXXXX
WNNNP
<COO>
YYWWNNN
    
```

Example

```

mMICREL
MIC29752WWT
2359P
USA
1521108
    
```

|                |  |  |
|----------------|--|--|
| <b>Legend:</b> | XX...X   | Product code or customer-specific information  |
|                | Y  | Year code (last digit of calendar year)  |
|                | YY   | Year code (last 2 digits of calendar year)   |
|                | WW   | Week code (week of January 1 is week '01')   |
|                | NNN  | Alphanumeric traceability code   |
|                | (e3)   | Pb-free JEDEC® designator for Matte Tin (Sn)   |
|                | *  | This package is Pb-free. The Pb-free JEDEC designator ((e3)) can be found on the outer packaging for this package. |
|                | •, ▲, ▼  | Pin one index is identified by a dot, delta up, or delta down (triangle mark).                                     |
| <b>Note:</b>   | In the event the full Microchip part number cannot be marked on one line, it will be carried over to the next line, thus limiting the number of available characters for customer-specific information. Package may or may not include the corporate logo. |  |
|                | Underbar ( _ ) and/or Overbar ( ¯ ) symbol may not be to scale.  |  |

# MIC2915X/30X/50X/75X

## 3-Lead TO-220 Package Outline and Recommended Land Pattern

**TITLE**

3 LEAD TO220 PACKAGE OUTLINE & RECOMMENDED LAND PATTERN

|                   |                |                    |           |
|-------------------|----------------|--------------------|-----------|
| <b>DRAWING #</b>  | TO220-3LD-PL-1 | <b>UNIT</b>        | INCH      |
| <b>Lead Frame</b> | Copper Alloy   | <b>Lead Finish</b> | Matte Tin |

Top View

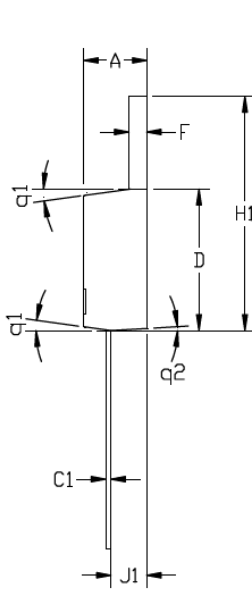
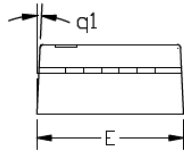
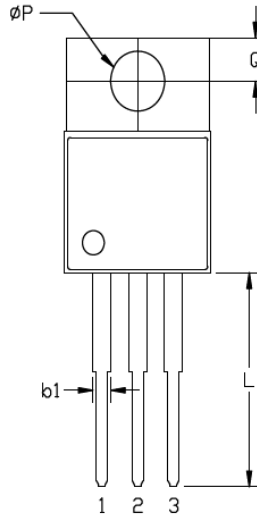

Btm View

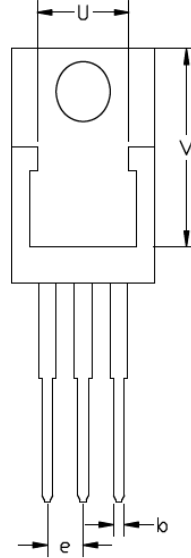

| POS | INCH  |       |
|-----|-------|-------|
|     | MIN   | MAX   |
| A   | 0.160 | 0.190 |
| b   | 0.025 | 0.040 |
| b1  | 0.045 | 0.060 |
| C1  | 0.012 | 0.022 |
| D   | 0.348 | 0.360 |
| E   | 0.385 | 0.420 |
| e   | 0.090 | 0.110 |
| F   | 0.045 | 0.055 |
| H1  | 0.541 | 0.619 |
| J1  | 0.080 | 0.120 |
| ØP  | 0.146 | 0.156 |
| Q   | 0.103 | 0.113 |
| L   | 0.500 | 0.580 |
| q1  | 3°    | 10°   |
| q2  | 1°    | 7°    |
| U   | 0.256 | Ref.  |
| V   | 0.486 | Ref.  |

Note : Foot Length using gauge plane method measurement 0.010".

Note: For the most current package drawings, please see the Microchip Packaging Specification located at <http://www.microchip.com/packaging>.

# MIC2915X/30X/50X/75X

## 5-Lead TO-220 Package Outline and Recommended Land Pattern

**TITLE**

5 LEAD TO220 PACKAGE OUTLINE & RECOMMENDED LAND PATTERN

|                   |                |                    |           |
|-------------------|----------------|--------------------|-----------|
| <b>DRAWING #</b>  | TO220-5LD-PL-1 | <b>UNIT</b>        | INCH      |
| <b>Lead Frame</b> | Copper Alloy   | <b>Lead Finish</b> | Matte Tin |



Note: For the most current package drawings, please see the Microchip Packaging Specification located at <http://www.microchip.com/packaging>.

# MIC2915X/30X/50X/75X

## 5-Lead TO-263 (DDPAK) Package Outline and Recommended Land Pattern

### 5-Lead Plastic (ET) [DDPAK]

**Note:** For the most current package drawings, please see the Microchip Packaging Specification located at <http://www.microchip.com/packaging>



| Dimension Limits      | Units | INCHES   |     |      |
|-----------------------|-------|----------|-----|------|
|                       |       | MIN      | NOM | MAX  |
| Number of Pins        | N     | 5        |     |      |
| Pitch                 | e     | .067 BSC |     |      |
| Overall Height        | A     | .160     | –   | .190 |
| Standoff §            | A1    | .000     | –   | .010 |
| Overall Width         | E     | .380     | –   | .420 |
| Exposed Pad Width     | E1    | .245     | –   | –    |
| Molded Package Length | D     | .330     | –   | .380 |
| Overall Length        | H     | .549     | –   | .625 |
| Exposed Pad Length    | D1    | .270     | –   | –    |
| Lead Thickness        | c     | .014     | –   | .029 |
| Pad Thickness         | C2    | .045     | –   | .065 |
| Lead Width            | b     | .020     | –   | .039 |
| Foot Length           | L     | .068     | –   | .110 |
| Pad Length            | L1    | –        | –   | .067 |
| Foot Angle            | φ     | 0°       | –   | 8°   |

**Notes:**

- § Significant Characteristic.
- Dimensions D and E do not include mold flash or protrusions. Mold flash or protrusions shall not exceed .005" per side.
- Dimensioning and tolerancing per ASME Y14.5M.

BSC: Basic Dimension. Theoretically exact value shown without tolerances.

Microchip Technology Drawing C04-012B

# MIC2915X/30X/50X/75X

5-Lead Plastic (ET) [DDPAK]

**Note:** For the most current package drawings, please see the Microchip Packaging Specification located at <http://www.microchip.com/packaging>

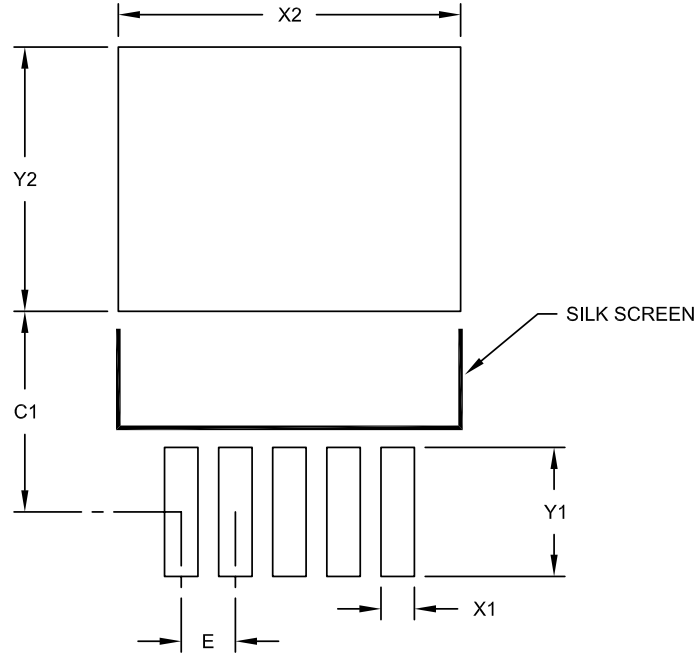

RECOMMENDED LAND PATTERN

| Dimension Limits           | Units | INCHES |          |      |
|----------------------------|-------|--------|----------|------|
|                            |       | MIN    | NOM      | MAX  |
| Contact Pitch              | E     |        | .067 BSC |      |
| Optional Center Pad Width  | X2    |        |          | .423 |
| Optional Center Pad Length | Y2    |        |          | .327 |
| Contact Pad Spacing        | C1    |        | .248     |      |
| Contact Pad Width (X5)     | X1    |        |          | .041 |
| Contact Pad Length (X5)    | Y1    |        |          | .159 |

Notes:

1. Dimensioning and tolerancing per ASME Y14.5M

BSC: Basic Dimension. Theoretically exact value shown without tolerances.

Microchip Technology Drawing No. C04-2012A

# MIC2915X/30X/50X/75X

## 3-Lead TO-263 Package Outline and Recommended Land Pattern

**TITLE**

3 LEAD TO263 PACKAGE OUTLINE & RECOMMENDED LAND PATTERN

**DRAWING #** TO263-3LD-PL-1

**UNIT** INCH/MM

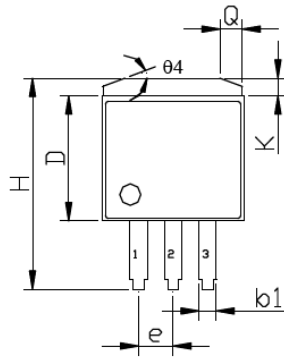

TOP VIEW



SIDE VIEW 1

| POS    | INCH  |       | MM     |        |
|--------|-------|-------|--------|--------|
|        | MIN   | MAX   | MIN    | MAX    |
| A      | 0.170 | 0.181 | 4.318  | 4.597  |
| A1     | 0.000 | 0.012 | 0.000  | 0.305  |
| b1     | 0.047 | 0.053 | 1.194  | 1.346  |
| C1     | 0.012 | 0.023 | 0.305  | 0.584  |
| D      | 0.330 | 0.361 | 8.382  | 9.169  |
| E      | 0.396 | 0.420 | 10.058 | 10.668 |
| e      | 0.095 | 0.105 | 2.413  | 2.667  |
| F      | 0.045 | 0.055 | 1.143  | 1.397  |
| H      | 0.575 | 0.625 | 14.605 | 15.875 |
| J1     | 0.080 | 0.120 | 2.032  | 3.048  |
| L1     | 0.090 | 0.110 | 2.286  | 2.794  |
| K      | 0.045 | 0.066 | 1.143  | 1.676  |
| theta1 | 3°    | 10°   | 3°     | 10°    |
| theta2 | 1°    | 7°    | 1°     | 7°     |
| theta3 | 0°    | 8°    | 0°     | 8°     |
| theta4 | 18°   | 22°   | 18°    | 22°    |
| Q      | 0.055 | 0.075 | 1.397  | 1.905  |
| U      | 0.256 | Ref.  | 6.502  | Ref.   |
| V      | 0.303 | Ref.  | 7.696  | Ref.   |

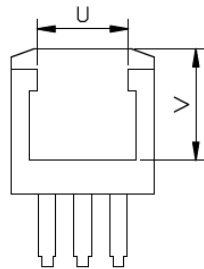

BOTTOM VIEW

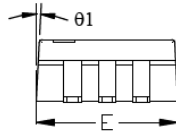

SIDE VIEW 2



RECOMMENDED LAND PATTERN (UNIT: INCH)

**NOTES:**

FOOT LENGTH USE GAUGE PLANE METHOD MEASUREMENT 0.010"

Note: For the most current package drawings, please see the Microchip Packaging Specification located at <http://www.microchip.com/packaging>.

# MIC2915X/30X/50X/75X

## 5-Lead TO-247 Package Outline and Recommended Land Pattern

**TITLE**

5 LEAD TO247 PACKAGE OUTLINE & RECOMMENDED LAND PATTERN

|                   |                |                    |           |
|-------------------|----------------|--------------------|-----------|
| <b>DRAWING #</b>  | TO247-5LD-PL-1 | <b>UNIT</b>        | INCH/ MM  |
| <b>Lead Frame</b> | Copper Alloy   | <b>Lead Finish</b> | Matte Tin |



**NOTE**

1. CONTROLLED DIMENSION IS INCH. DIMENSION IN BLANKET IS MILLIMETER.
2. DIMENSIONS DO NOT INCLUDE END FLASH, MOLD FLASH, MATERIAL PROTRUSIONS.

Note: For the most current package drawings, please see the Microchip Packaging Specification located at <http://www.microchip.com/packaging>.

# MIC2915X/30X/50X/75X

## 5-Lead TO-252 Package Outline and Recommended Land Pattern

**TITLE**

5 LEAD TO252 PACKAGE OUTLINE & RECOMMENDED LAND PATTERN

|                   |                |                    |           |
|-------------------|----------------|--------------------|-----------|
| <b>DRAWING #</b>  | TO252-5LD-PL-1 | <b>UNIT</b>        | INCH/ MM  |
| <b>Lead Frame</b> | Copper Alloy   | <b>Lead Finish</b> | Matte Tin |

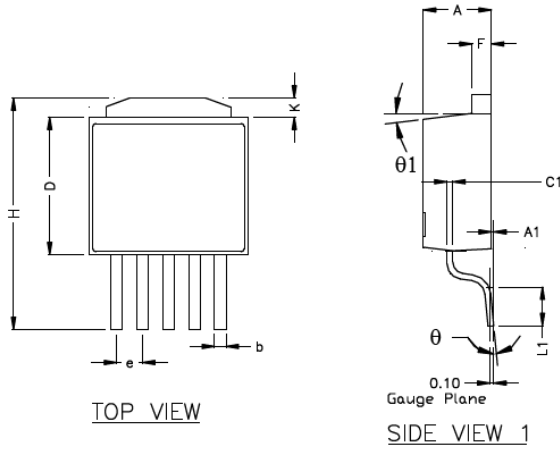

| POS    | INCH  |       | MM    |        |
|--------|-------|-------|-------|--------|
|        | MIN   | MAX   | MIN   | MAX    |
| A      | 0.087 | 0.094 | 2.210 | 2.387  |
| A1     | 0.000 | 0.012 | 0.000 | 0.305  |
| b      | 0.023 | 0.026 | 0.584 | 0.660  |
| C1     | 0.012 | 0.023 | 0.305 | 0.584  |
| D      | 0.236 | 0.241 | 6.000 | 6.200  |
| E      | 0.252 | 0.260 | 6.400 | 6.604  |
| e      | 0.045 | 0.055 | 1.143 | 1.397  |
| F      | 0.019 | 0.023 | 0.483 | 0.584  |
| H      | 0.378 | 0.402 | 9.601 | 10.210 |
| K      | 0.039 | 0.047 | 1.000 | 1.200  |
| L1     | 0.055 | 0.065 | 1.397 | 1.651  |
| theta  | 0°    | 8°    | 0°    | 8°     |
| theta1 | 3°    | 10°   | 3°    | 10°    |
| Q      | 0.055 | 0.075 | 1.397 | 1.905  |
| U      | 0.206 | Ref.  | 5.232 | Ref.   |
| V      | 0.213 | Ref.  | 5.415 | Ref.   |

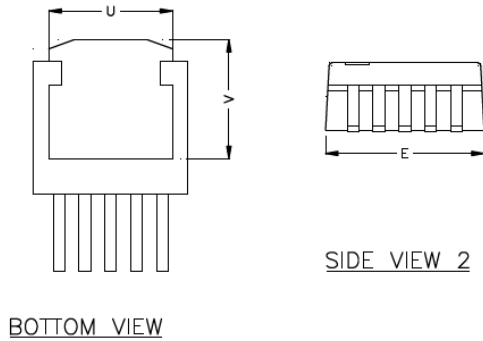

NOTE: unit in mm

- NOTE:
1. PACKAGE OUTLINE EXCLUSIVE OF MOLD FLASH & METAL BURR.
  2. PACKAGE OUTLINE INCLUSIVE OF PLATING THICKNESS.
  3. FOOT LENGTH USING GAUGE PLANE METHOD MEASUREMENT 0.010"
  4. ALL DIMENSIONS ARE IN INCHES/MILLIMETERS.

Note: For the most current package drawings, please see the Microchip Packaging Specification located at <http://www.microchip.com/packaging>.

# MIC2915X/30X/50X/75X

---

NOTES:

## APPENDIX A: REVISION HISTORY

### Revision A (December 2016)

- Converted Micrel document MIC2915x/30x/50x/75x to Microchip data sheet DS20005685A.
- Minor text changes throughout.
- Removed references to the discontinued MIC29750.
- Added [Figure 2-41](#), [Figure 2-42](#), and [Figure 2-43](#).
- Removed the 3-Pin TO-247 package option.

### Revision B (January 2019)

- Updated package drawing for [5-Lead TO-263 \(DDPAK\) Package Outline and Recommended Land Pattern](#) option.

# MIC2915X/30X/50X/75X

---

NOTES:

# MIC2915X/30X/50X/75X

## PRODUCT IDENTIFICATION SYSTEM

To order or obtain information, e.g., on pricing or delivery, contact your local Microchip representative or sales office.

| <u>PART NO.</u>   | -         | <u>XX</u>                               | <u>X</u> | <u>X</u>   | - | <u>XX</u> |
|---|-----------|---|----------|------------|---|-----------|
| Device  | Voltage   | Junction<br>Temperature Range           | Package  | Media Type |   |           |
| <b>Device:</b>  | MIC2915x: | 1.5A High-Current Low-Dropout Regulator |          |            |   |           |
|   | MIC2930x: | 3A High-Current Low-Dropout Regulator   |          |            |   |           |
|   | MIC2950x: | 5A High-Current Low-Dropout Regulator   |          |            |   |           |
|   | MIC2975x: | 7.5A High-Current Low-Dropout Regulator |          |            |   |           |
| <b>Voltage:</b>   | 3.3       | = 3.3V                                  |          |            |   |           |
|   | 5.0       | = 5.0V                                  |          |            |   |           |
|   | 12        | = 12V                                   |          |            |   |           |
|   | (blank)   | = Adjustable                            |          |            |   |           |
| <b>Junction<br/>Temperature<br/>Range:</b>  | W         | = -40°C to +125°C                       |          |            |   |           |
| <b>Package:</b>   | U         | = 3-Lead or 5-Lead TO-263               |          |            |   |           |
|   | T         | = 3-Lead or 5-Lead TO-220               |          |            |   |           |
|   | D         | = 5-Lead TO-252                         |          |            |   |           |
|   | WT        | = 5-Lead TO-247                         |          |            |   |           |
| <b>Media Type:</b>  | TR        | = 2,500/Reel for D and WT Packages      |          |            |   |           |
|   | TR        | = 750/Reel for U Package                |          |            |   |           |
|   | (blank)   | = 50/Tube for U, T, and D Packages      |          |            |   |           |
|   | (blank)   | = 30/Tube for WT Package                |          |            |   |           |
| <b>Examples:</b>  |           |   |          |            |   |           |
| a) MIC29150-3.3WT: 1.5A High-Current Low-Dropout Regulator, 3.3V, -40°C to +125°C Temperature Range, 3-Lead TO-220, 50/Tube   |           |   |          |            |   |           |
| b) MIC29152WD-TR: 1.5A High-Current Low-Dropout Regulator, Adjustable Voltage, -40°C to +125°C Temperature Range, 5-Lead TO-252, 2,500/Reel   |           |   |          |            |   |           |
| c) MIC29302WU: 3A High-Current Low-Dropout Regulator, Adjustable Voltage, -40°C to +125°C Temperature Range, 5-Lead TO-263, 50/Tube   |           |   |          |            |   |           |
| d) MIC29301-12WU-TR: 3A High-Current Low-Dropout Regulator, 12V, -40°C to +125°C Temperature Range, 5-Lead TO-263, 750/Reel   |           |   |          |            |   |           |
| e) MIC29500-5.0WT: 5A High-Current Low-Dropout Regulator, 5.0V, -40°C to +125°C Temperature Range, 3-Lead TO-220, 50/Tube   |           |   |          |            |   |           |
| f) MIC29503WT: 5A High-Current Low-Dropout Regulator, Adjustable Voltage, -40°C to +125°C Temperature Range, 5-Lead TO-220, 50/Tube   |           |   |          |            |   |           |
| g) MIC29751-3.3WWT-TR: 7.5A High-Current Low-Dropout Regulator, 3.3V, -40°C to +125°C Temperature Range, 5-Lead TO-247, 2,500/Reel  |           |   |          |            |   |           |
| h) MIC29752WWT: 7.5A High-Current Low-Dropout Regulator, Adjustable Voltage, -40°C to +125°C Temperature Range, 5-Lead TO-247, 30/Tube  |           |   |          |            |   |           |
| <b>Note 1:</b> Tape and Reel identifier only appears in the catalog part number description. This identifier is used for ordering purposes and is not printed on the device package. Check with your Microchip Sales Office for package availability with the Tape and Reel option. |           |   |          |            |   |           |

# MIC2915X/30X/50X/75X

---

NOTES:

---

**Note the following details of the code protection feature on Microchip devices:**

- Microchip products meet the specification contained in their particular Microchip Data Sheet.
- Microchip believes that its family of products is one of the most secure families of its kind on the market today, when used in the intended manner and under normal conditions.
- There are dishonest and possibly illegal methods used to breach the code protection feature. All of these methods, to our knowledge, require using the Microchip products in a manner outside the operating specifications contained in Microchip's Data Sheets. Most likely, the person doing so is engaged in theft of intellectual property.
- Microchip is willing to work with the customer who is concerned about the integrity of their code.
- Neither Microchip nor any other semiconductor manufacturer can guarantee the security of their code. Code protection does not mean that we are guaranteeing the product as “unbreakable.”

Code protection is constantly evolving. We at Microchip are committed to continuously improving the code protection features of our products. Attempts to break Microchip's code protection feature may be a violation of the Digital Millennium Copyright Act. If such acts allow unauthorized access to your software or other copyrighted work, you may have a right to sue for relief under that Act.

---

Information contained in this publication regarding device applications and the like is provided only for your convenience and may be superseded by updates. It is your responsibility to ensure that your application meets with your specifications. MICROCHIP MAKES NO REPRESENTATIONS OR WARRANTIES OF ANY KIND WHETHER EXPRESS OR IMPLIED, WRITTEN OR ORAL, STATUTORY OR OTHERWISE, RELATED TO THE INFORMATION, INCLUDING BUT NOT LIMITED TO ITS CONDITION, QUALITY, PERFORMANCE, MERCHANTABILITY OR FITNESS FOR PURPOSE. Microchip disclaims all liability arising from this information and its use. Use of Microchip devices in life support and/or safety applications is entirely at the buyer's risk, and the buyer agrees to defend, indemnify and hold harmless Microchip from any and all damages, claims, suits, or expenses resulting from such use. No licenses are conveyed, implicitly or otherwise, under any Microchip intellectual property rights unless otherwise stated.

*Microchip received ISO/TS-16949:2009 certification for its worldwide headquarters, design and wafer fabrication facilities in Chandler and Tempe, Arizona; Gresham, Oregon and design centers in California and India. The Company's quality system processes and procedures are for its PIC® MCUs and dsPIC® DSCs, KEELOQ® code hopping devices, Serial EEPROMs, microperipherals, nonvolatile memory and analog products. In addition, Microchip's quality system for the design and manufacture of development systems is ISO 9001:2000 certified.*

**QUALITY MANAGEMENT SYSTEM  
CERTIFIED BY DNV  
= ISO/TS 16949 =**

**Trademarks**

The Microchip name and logo, the Microchip logo, AnyRate, AVR, AVR logo, AVR Freaks, BitCloud, chipKIT, chipKIT logo, CryptoMemory, CryptoRF, dsPIC, FlashFlex, flexPWR, Heldo, JukeBlox, KeeLoq, Klear, LANCheck, LINK MD, maXStylus, maXTouch, MediaLB, megaAVR, MOST, MOST logo, MPLAB, OptoLyzer, PIC, picoPower, PICSTART, PIC32 logo, Prochip Designer, QTouch, SAM-BA, SpyNIC, SST, SST Logo, SuperFlash, tinyAVR, UNI/O, and XMEGA are registered trademarks of Microchip Technology Incorporated in the U.S.A. and other countries.

ClockWorks, The Embedded Control Solutions Company, EtherSynch, Hyper Speed Control, HyperLight Load, IntellIMOS, mTouch, Precision Edge, and Quiet-Wire are registered trademarks of Microchip Technology Incorporated in the U.S.A.

Adjacent Key Suppression, AKS, Analog-for-the-Digital Age, Any Capacitor, AnyIn, AnyOut, BodyCom, CodeGuard, CryptoAuthentication, CryptoAutomotive, CryptoCompanion, CryptoController, dsPICDEM, dsPICDEM.net, Dynamic Average Matching, DAM, ECAN, EtherGREEN, In-Circuit Serial Programming, ICSP, INICnet, Inter-Chip Connectivity, JitterBlocker, KlearNet, KlearNet logo, memBrain, Mindi, MiWi, motorBench, MPASM, MPF, MPLAB Certified logo, MPLIB, MPLINK, MultiTRAK, NetDetach, Omniscient Code Generation, PICDEM, PICDEM.net, PICKit, PICtail, PowerSmart, PureSilicon, QMatrix, REAL ICE, Ripple Blocker, SAM-ICE, Serial Quad I/O, SMART-I.S., SQI, SuperSwitcher, SuperSwitcher II, Total Endurance, TSHARC, USBCheck, VariSense, ViewSpan, WiperLock, Wireless DNA, and ZENA are trademarks of Microchip Technology Incorporated in the U.S.A. and other countries.

SQTP is a service mark of Microchip Technology Incorporated in the U.S.A.

Silicon Storage Technology is a registered trademark of Microchip Technology Inc. in other countries.

GestIC is a registered trademark of Microchip Technology Germany II GmbH & Co. KG, a subsidiary of Microchip Technology Inc., in other countries.

All other trademarks mentioned herein are property of their respective companies.

© 2016-2019, Microchip Technology Incorporated, All Rights Reserved.

ISBN: 978-1-5224-4105-2



# MICROCHIP

## Worldwide Sales and Service

### AMERICAS

**Corporate Office**  
2355 West Chandler Blvd.  
Chandler, AZ 85224-6199  
Tel: 480-792-7200  
Fax: 480-792-7277  
Technical Support:  
<http://www.microchip.com/support>  
Web Address:  
[www.microchip.com](http://www.microchip.com)

#### Atlanta

Duluth, GA  
Tel: 678-957-9614  
Fax: 678-957-1455

#### Austin, TX

Tel: 512-257-3370

#### Boston

Westborough, MA  
Tel: 774-760-0087  
Fax: 774-760-0088

#### Chicago

Itasca, IL  
Tel: 630-285-0071  
Fax: 630-285-0075

#### Dallas

Addison, TX  
Tel: 972-818-7423  
Fax: 972-818-2924

#### Detroit

Novi, MI  
Tel: 248-848-4000

#### Houston, TX

Tel: 281-894-5983

#### Indianapolis

Noblesville, IN  
Tel: 317-773-8323  
Fax: 317-773-5453  
Tel: 317-536-2380

#### Los Angeles

Mission Viejo, CA  
Tel: 949-462-9523  
Fax: 949-462-9608  
Tel: 951-273-7800

#### Raleigh, NC

Tel: 919-844-7510

#### New York, NY

Tel: 631-435-6000

#### San Jose, CA

Tel: 408-735-9110  
Tel: 408-436-4270

#### Canada - Toronto

Tel: 905-695-1980  
Fax: 905-695-2078

### ASIA/PACIFIC

**Australia - Sydney**  
Tel: 61-2-9868-6733

**China - Beijing**  
Tel: 86-10-8569-7000

**China - Chengdu**  
Tel: 86-28-8665-5511

**China - Chongqing**  
Tel: 86-23-8980-9588

**China - Dongguan**  
Tel: 86-769-8702-9880

**China - Guangzhou**  
Tel: 86-20-8755-8029

**China - Hangzhou**  
Tel: 86-571-8792-8115

**China - Hong Kong SAR**  
Tel: 852-2943-5100

**China - Nanjing**  
Tel: 86-25-8473-2460

**China - Qingdao**  
Tel: 86-532-8502-7355

**China - Shanghai**  
Tel: 86-21-3326-8000

**China - Shenyang**  
Tel: 86-24-2334-2829

**China - Shenzhen**  
Tel: 86-755-8864-2200

**China - Suzhou**  
Tel: 86-186-6233-1526

**China - Wuhan**  
Tel: 86-27-5980-5300

**China - Xian**  
Tel: 86-29-8833-7252

**China - Xiamen**  
Tel: 86-592-2388138

**China - Zhuhai**  
Tel: 86-756-3210040

### ASIA/PACIFIC

**India - Bangalore**  
Tel: 91-80-3090-4444

**India - New Delhi**  
Tel: 91-11-4160-8631

**India - Pune**  
Tel: 91-20-4121-0141

**Japan - Osaka**  
Tel: 81-6-6152-7160

**Japan - Tokyo**  
Tel: 81-3-6880-3770

**Korea - Daegu**  
Tel: 82-53-744-4301

**Korea - Seoul**  
Tel: 82-2-554-7200

**Malaysia - Kuala Lumpur**  
Tel: 60-3-7651-7906

**Malaysia - Penang**  
Tel: 60-4-227-8870

**Philippines - Manila**  
Tel: 63-2-634-9065

**Singapore**  
Tel: 65-6334-8870

**Taiwan - Hsin Chu**  
Tel: 886-3-577-8366

**Taiwan - Kaohsiung**  
Tel: 886-7-213-7830

**Taiwan - Taipei**  
Tel: 886-2-2508-8600

**Thailand - Bangkok**  
Tel: 66-2-694-1351

**Vietnam - Ho Chi Minh**  
Tel: 84-28-5448-2100

### EUROPE

**Austria - Wels**  
Tel: 43-7242-2244-39  
Fax: 43-7242-2244-393

**Denmark - Copenhagen**  
Tel: 45-4450-2828  
Fax: 45-4485-2829

**Finland - Espoo**  
Tel: 358-9-4520-820

**France - Paris**  
Tel: 33-1-69-53-63-20  
Fax: 33-1-69-30-90-79

**Germany - Garching**  
Tel: 49-8931-9700

**Germany - Haan**  
Tel: 49-2129-3766400

**Germany - Heilbronn**  
Tel: 49-7131-67-3636

**Germany - Karlsruhe**  
Tel: 49-721-625370

**Germany - Munich**  
Tel: 49-89-627-144-0  
Fax: 49-89-627-144-44

**Germany - Rosenheim**  
Tel: 49-8031-354-560

**Israel - Ra'anana**  
Tel: 972-9-744-7705

**Italy - Milan**  
Tel: 39-0331-742611  
Fax: 39-0331-466781

**Italy - Padova**  
Tel: 39-049-7625286

**Netherlands - Drunen**  
Tel: 31-416-690399  
Fax: 31-416-690340

**Norway - Trondheim**  
Tel: 47-7288-4388

**Poland - Warsaw**  
Tel: 48-22-3325737

**Romania - Bucharest**  
Tel: 40-21-407-87-50

**Spain - Madrid**  
Tel: 34-91-708-08-90  
Fax: 34-91-708-08-91

**Sweden - Gothenberg**  
Tel: 46-31-704-60-40

**Sweden - Stockholm**  
Tel: 46-8-5090-4654

**UK - Wokingham**  
Tel: 44-118-921-5800  
Fax: 44-118-921-5820

## Looking for pricing, stock, or lifecycle information?

Click below to explore more details on WIN SOURCE:

- ⊖ [View MIC29301-5.0WT on WIN SOURCE](#)
- ⊖ [Microchip Technology](#) Information

## Optimize Your Supply Chain with WIN SOURCE Solutions

- ✓ Global Sourcing Solution
- ✓ Obsolete Management
- ✓ Cost Control Management
- ✓ Shortage Management
- ✓ Alternative Solution
- ✓ Excess Inventory Management