



**THE DATASHEET OF  
LP2951CS-L-5-0/TR**





Is Now A Part Of



Visit [www.maxlinear.com](http://www.maxlinear.com)  
for more information about  
MaxLinear Inc.





## ABSOLUTE MAXIMUM RATINGS

Power Dissipation.....Internally Limited	Feedback Input Voltage.....-1.5V to +30V
Lead Temp. (Soldering, 5 Seconds).....260°C	Shutdown Input Voltage.....-0.3V to +30V
Storage Temperature Range.....-65° to +150°C	Error Comparator Output.....-0.3V to +30V
Operating Junction Temperature Range -40C to +125C	ESD Rating .....2kV Min
Input Supply Voltage.....-0.3V to +30V	

## ELECTRICAL CHARACTERISTICS $V_{IN}=6V$ , $I_O=100\mu A$ , $C_{OUT}=1\mu F$ (Note 2) $T_A=25^\circ C$ , unless otherwise noted

PARAMETER	CONDITIONS	LP2950AC LP2951AC			LP2950C LP2951C			UNITS
		Min.	Typ.	Max.	Min.	Typ.	Max.	
<b>3.3 V Versions</b>								
Output Voltage	$T_J = 25^\circ C$	3.284	3.3	3.317	3.267	3.3	3.333	V
	$-25^\circ C \leq T_J \leq 85^\circ C$	3.267	3.3	3.333	3.251	3.3	3.350	
	Full Operating Temperature	3.260	3.3	3.340	3.234	3.3	3.366	
Output Voltage	$100\mu A \leq I_L \leq 100\text{ mA}$ $T_J \leq T_{MAX}$	3.254	3.3	3.346	3.221	3.3	3.379	V
<b>5 V Versions</b>								
Output Voltage	$T_J = 25^\circ C$	4.975	5.0	5.025	4.950	5.0	5.050	V
	$-25^\circ C \leq T_J \leq 85^\circ C$	4.950	5.0	5.050	4.925	5.0	5.075	
	Full Operating Temperature	4.940	5.0	5.060	4.900	5.0	5.100	
Output Voltage	$100\mu A \leq I_L \leq 100\text{ mA}$ $T_J \leq T_{MAX}$	4.925	5.0	5.075	4.880	5.0	5.120	V
<b>All Voltage Options</b>								
Output Voltage Temperature Coefficient	(Note 1)		20	120		50	150	ppm/ $^\circ C$
Line Regulation (Note 3)	$6V \leq V_{IN} \leq 30V$ (Note 4)		0.03	0.1		0.04	0.2	%
Load Regulation (Note 3)	$100\mu A \leq I_L \leq 100\text{ mA}$		0.04	0.1		0.1	0.2	%
Dropout Voltage (Note 5)	$I_L = 100\mu A$		50	80		50	80	mV
	$I_L = 100\text{ mA}$		380	450		380	450	mV
Ground Current	$I_L = 100\mu A$		150	170		150	170	$\mu A$
	$I_L = 100\text{ mA}$		8	12		8	12	mA
Current Limit	$V_{OUT} = 0$		150	200		150	200	mA
Thermal Regulation			0.05	0.2		0.05	0.2	%/W
Output Noise, 10Hz to 100KHz	$C_L = 1\mu F$		430			430		$\mu V$ rms
	$C_L = 200\mu F$		160			160		$\mu V$ rms
	$C_L = 3.3\mu F$ , Bypass = 0.01 $\mu F$ from Pin 7 to Pin 1 (LP2951)		100			100		$\mu V$ rms
<b>8-Pin Versions only</b>		<b>LP2951AC</b>			<b>LP2951C</b>			
Reference Voltage		1.220	1.235	1.250	1.210	1.235	1.260	V
Reference Voltage	Over Temperature (Note 6)	1.190		1.270	1.185		1.285	V
Feedback Pin Bias Current			40	60		40	60	nA

PARAMETER	CONDITIONS (Note 2)	LP2951AC			LP2951C			UNITS
		Min.	Typ.	Max.	Min.	Typ.	Max.	
<b>8-Pin Versions only (Continued)</b>								
Reference Voltage Temperature Coefficient			20			50		ppm/°C
Feedback Pin Bias Current Temperature Coefficient			0.1			0.1		nA/°C
<b>Error Comparator</b>								
Output Leakage Current	$V_{OH} = 30V$		0.01	1		0.01	1	μA
Output Low Voltage	$V_{IN} = 4.5V$ $I_{OL} = 400 \mu A$		150	250		150	250	mV
Upper Threshold Voltage	(Note 7)		40	60		40	60	mV
Lower Threshold Voltage	(Note 7)		75	95		75	95	mV
Hysteresis	(Note 7)		15			15		mV
<b>Shutdown Input</b>								
Input logic Voltage	Low (Regulator ON) High (Regulator OFF)		2.0	1.3 0.7		2.0	1.3 0.7	V V
Shut down Pin Input Current	$V_S = 2.4V$ $V_S = 30V$		30 675	50 800		30 675	50 800	μA μA
Regulator Output Current in Shutdown	(Note 8)		3	10		3	10	μA
Thermal Resistance $\theta_{JA}$	8 Pin SOIC		128.4					°C/W
	3 Pin TO-92		131.9					°C/W

**Note 1:** Output or reference voltage temperature coefficients defined as the worst case voltage change divided by the total temperature range.

**Note 2:** Unless otherwise specified all limits guaranteed for  $T_J = 25^\circ C$ ,  $V_{IN} = 6V$ ,  $I_L = 100 \mu A$  and  $C_L = 1 \mu F$ . Additional conditions for the 8-pin versions are feedback tied to 5V tap and output tied to output sense ( $V_{OUT} = 5V$ ) and  $V_{SHUTDOWN} \leq 0.8V$ .

**Note 3:** Regulation is measured at constant junction temperature, using pulse testing with a low duty cycle. Changes in output voltage due to heating effects are covered under the specification for thermal regulation.

**Note 4:** Line regulation for the LP2951 is tested at  $I_L = 1mA$ . For  $I_L = 100 \mu A$  and  $T_J = 125^\circ C$ , line regulation is guaranteed by design to 0.2%. See typical performance characteristics for line regulation versus temperature and load current.

**Note 5:** Dropout voltage is defined as the input to output differential at which the output voltage drops 100 mV below its nominal value measured at 1V differential. At very low values of programmed output voltage, the minimum input supply voltage of 2V (2.3V over temperature) must be taken into account.

**Note 6:**  $V_{REF} \leq V_{OUT} \leq (V_{IN} - 1V)$ ,  $2.3 \leq V_{IN} \leq 30V$ ,  $100 \mu A \leq I_L \leq 100mA$ ,  $T_J \leq T_{JMAX}$ .

**Note 7:** Comparator thresholds are expressed in terms of a voltage differential at the feedback terminal below the nominal reference voltage measured at 6V input. To express these thresholds in terms of output voltage change, multiply by the error amplifier gain =  $V_{OUT}/V_{REF} = (R_1 + R_2)/R_2$ . For example, at a programmed output voltage of 5V, the error output is guaranteed to go low when the output drops by  $95 mV \times 5V/1.235 = 384 mV$ . Thresholds remain constant as a percent of  $V_{OUT}$  as  $V_{OUT}$  is varied, with the dropout warning occurring at typically 5% below nominal, 7.5% guaranteed.

**Note 8:**  $V_{SHUTDOWN} \geq 2V$ ,  $V_{IN} \leq 30V$ ,  $V_{OUT} = 0$ , Feedback pin tied to 5V Tap.

**Note 9:** All typical values are not guaranteed. The value could vary from lot to lot.

## TYPICAL PERFORMANCE CHARACTERISTIC

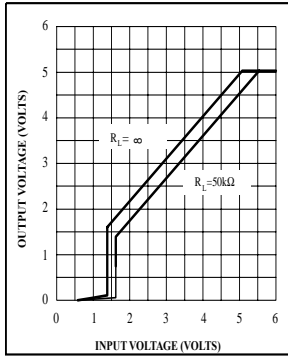

Dropout Characteristics

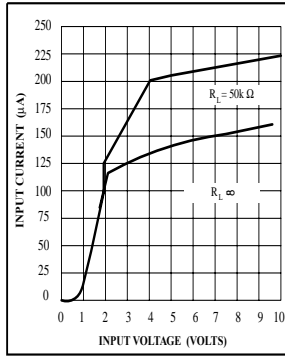

Input Current

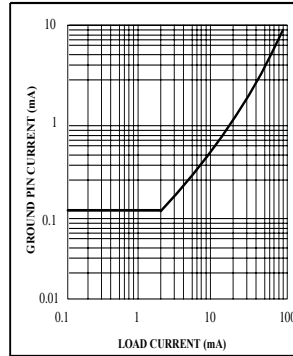

Quiescent Current

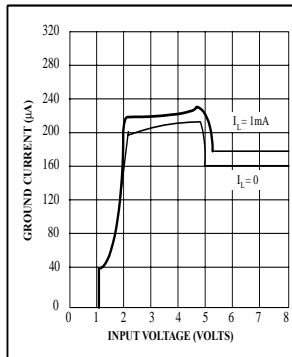

Ground Current

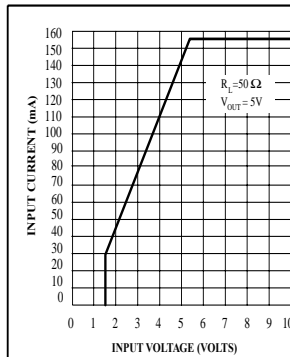

Input Current

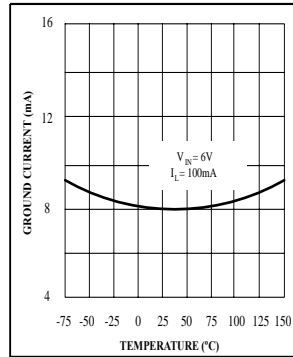

Ground Current

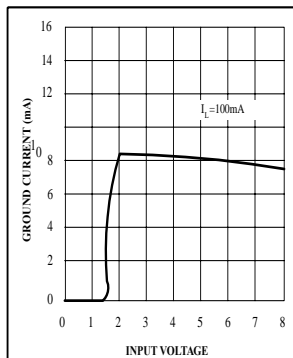

Ground Current

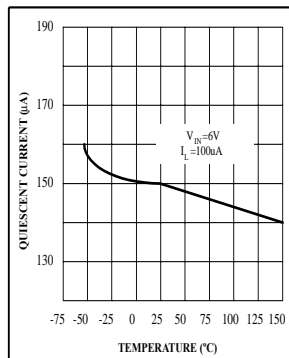

Quiescent Current

## TYPICAL PERFORMANCE CHARACTERISTICS (continued)

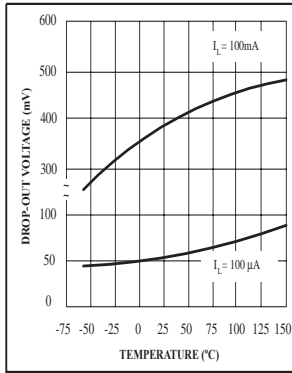

Drop-Out Voltage

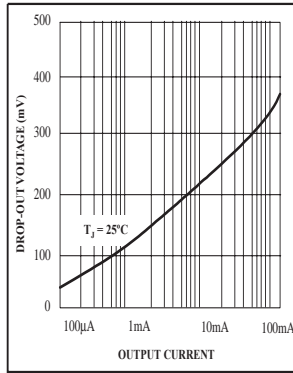

Drop-Out Voltage

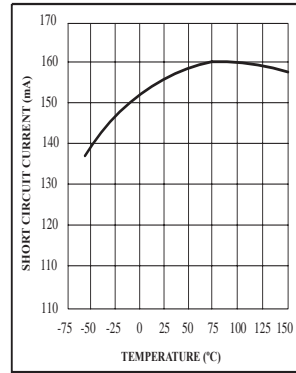

Short Circuit Current

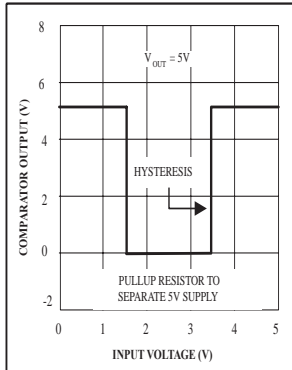

Error Comparator Output

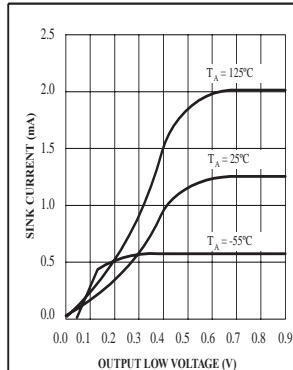

LP2951 Comparator Sink Current

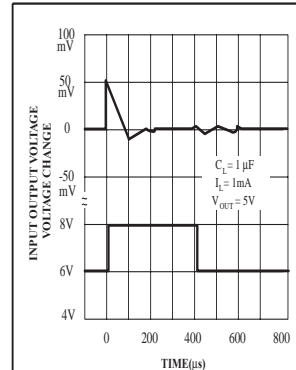

Line Transient Response

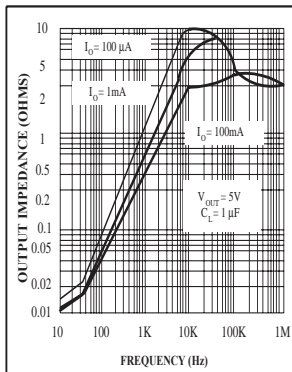

Output Impedance

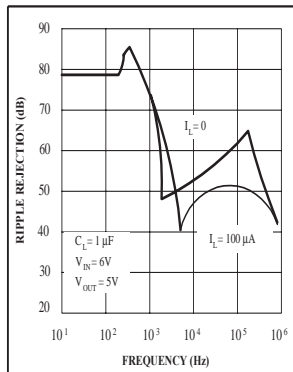

Ripple Rejection

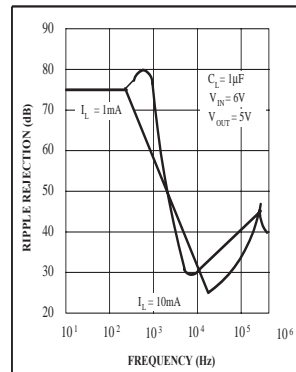

Ripple Rejection

## TYPICAL PERFORMANCE CHARACTERISTICS (continued)

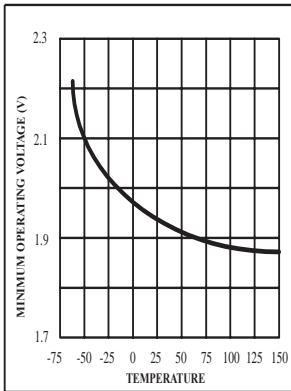

LP2951 Minimum Operating Voltage

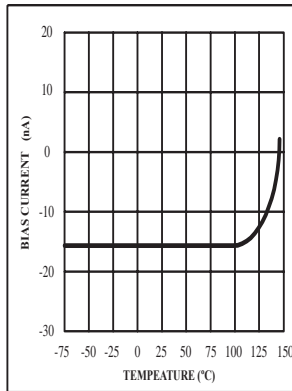

LP2951 Feedback Bias Current

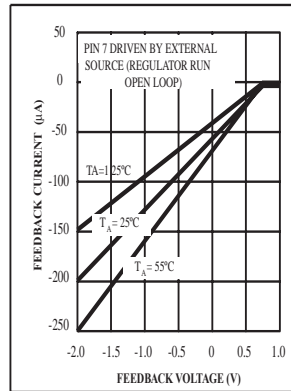

LP2951 Feedback Pin Current

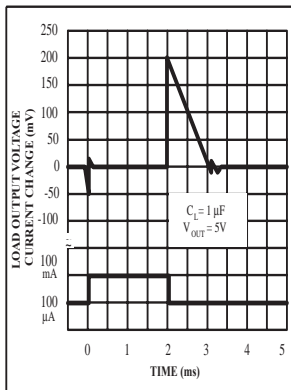

Load Transient Response

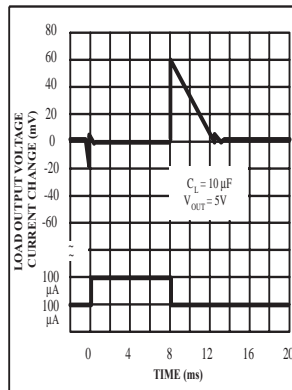

Load Transient Response

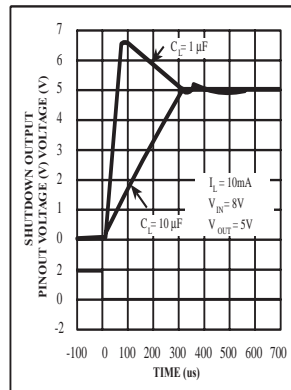

Enable Transient

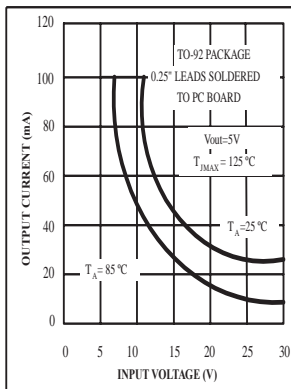

LP2950 Maximum Rated Output

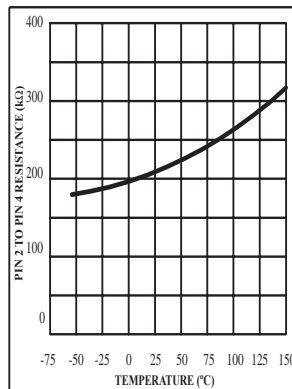

LP2951 Divider Resistance

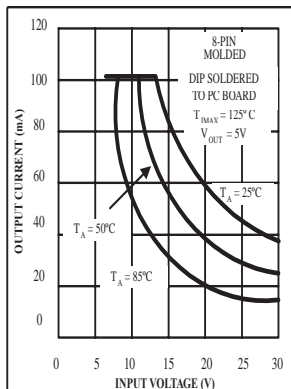

LP2950 Maximum Rated Output Current

## TYPICAL APPLICATIONS

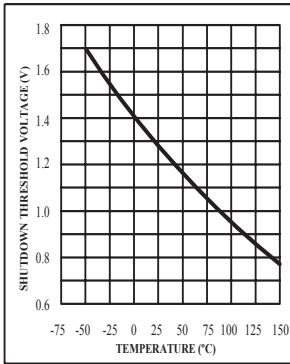

Shutdown Threshold Voltage

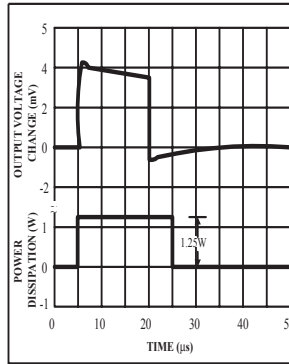

Thermal Response

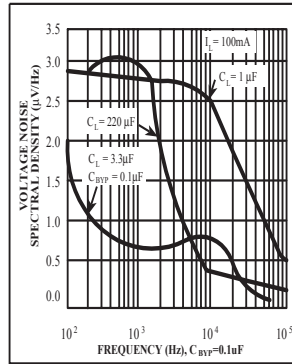

Output Noise

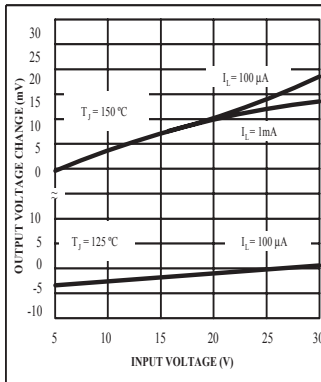

Line Regulation

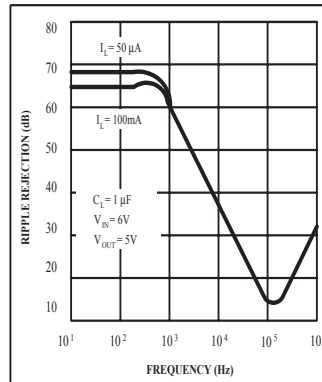

Ripple Rejection

## APPLICATION HINTS

### EXTERNAL CAPACITORS

The stability of the LP2950/LP2951 requires a 1.0 $\mu$ F or greater capacitor between output and ground. Oscillation could occur without this capacitor. Most types of tantalum or aluminum electrolytic works fine here. For operations below -25°C solid tantalum is recommended since the many aluminum types have electrolytes that freeze at about -30°C. The ESR of about 5 $\Omega$  or less and resonant frequency above 500kHz are the most important parameters in the value of the capacitor. The capacitors value may be increased without limit.

At lower values of output current, less output capacitance is required for stability. For the currents below 10mA the value of the capacitor can be reduced to 0.33 $\mu$ F and 0.1 $\mu$ F for 1mA. More output capacitance is needed for the 8-pin version at voltages below 5V since it runs the error amplifier at lower gain. At worst case 3.3  $\mu$ F or greater must be used for the condition of 100mA load at 1.23V output.

The LP2950/51 unlike other low dropout regulators will remain stable and in regulation with no load in addition to the internal voltage divider. This feature is especially important in applications like CMOS RAM keep-alive. When setting the output voltage of the LP2950/51 version with external resistors, a minimum load of 1 $\mu$ A is recommended

If there is more than 10 inches of wire between the input and the AC filter capacitor or if a battery is used as the input then a 1 $\mu$ A tantalum or aluminum electrolytic capacitor should be placed from the input to the ground.

Instability can occur if there is stray capacitance to the LP2951 feedback terminal (pin 7). This could cause more problems when using a higher value of external resistors to set the output voltage. This problem can be fixed by adding a 100pF capacitor between output and feedback and increasing the output capacitor to at least 3.3  $\mu$ F.

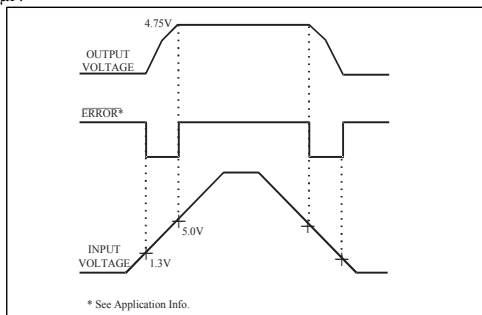

Figure 1. ERROR Output Timing

### ERROR DETECTION COMPARATOR OUTPUT

The Comparator produces a logic low output whenever the LP2951 output falls out of regulation by more than around 5%. This is around 60 mV offset divided by the 1.235 reference voltage. This trip level

remains 5% below normal regardless of the programmed output voltage of the regulator.

Figure 1 shows the timing diagram depicting the ERROR signal and the regulator output voltage as the LP2951 input is ramped up and down. The ERROR signal becomes low at around 1.3V input, and goes high around 5V input (input voltage at which  $V_{OUT} = 4.75$ ).

Since the LP2951's dropout voltage is load dependent, the input voltage trip point (around 5V) will vary with the load current. The output voltage trip point (approx. 4.75V) does not vary with load.

The error comparator has an open-collector output, which requires an external pull-up resistor. Depending on the system requirements the resistor may be returned to 5V output or other supply voltage. In determining the value of this resistor, note that the output is rated to sink 400 $\mu$ A, this value adds to battery drain in a low battery condition. Suggested values range from 100K to 1M $\Omega$ . If the output is unused this resistor is not required.

### PROGRAMMING THE OUTPUT VOLTAGE OF LP2951

The LP2951 may be pin-strapped for 5V using its internal voltage divider by tying Pin 1 (output) to Pin 2 (sense) and Pin 7 (feedback) to Pin 6 (5V Tap). Also, it may be programmed for any output voltage between its 1.235V reference and its 29V maximum rating. As seen in Figure 2, an external pair of resistors is required. Refer to the below equation for the programming of the output voltage:

$$V_{OUT} = V_{REF} \times (1 + R_1/R_2) + I_{FB}R_1$$

The  $V_{REF}$  is 1.235 and  $I_{FB}$  is the feedback bias current, nominally -20nA. The minimum recommended load current of 1  $\mu$ A forces an upper limit of 1.2M $\Omega$  on value of  $R_2$ . If no load is presented the  $I_{FB}$  produces an error of typically 2% in  $V_{OUT}$  which may be eliminated at room temperature by trimming  $R_1$ . To improve the accuracy choose the value of  $R_2 = 100k$  this reduces the error by 0.17% and increases the resistor program current by 12 $\mu$ A. Since the LP2951 typically draws 60 $\mu$ A at no load with Pin 2 open-circuited this is a small price to pay

### REDUCING OUTPUT NOISE

It may be an advantage to reduce the AC noise present at the output. One way is to reduce the regulator bandwidth by increasing the size of the output capacitor. This is the only way that noise can be reduced on the 3 lead LP2950 but is relatively inefficient, as increasing the capacitor from 1 $\mu$ F to 220  $\mu$ F only decreases the noise from 430 $\mu$ V to 160 $\mu$ V<sub>RMS</sub> for a 100kHz bandwidth at 5V output. Noise could also be reduced fourfold by a bypass capacitor across  $R_1$ , since it reduces the high frequency gain from 4 to unity. Pick

$$C_{BYPASS} \cong 1 / 2 \pi R_1 \times 200 \text{ Hz}$$

or choose 0.01 $\mu$ F. When doing this, the output capacitor must be increased to 3.3 $\mu$ F to maintain stability. These changes reduce the output noise from 430 $\mu$ V to 100 $\mu$ V<sub>RMS</sub> for a 100kHz bandwidth at 5V output. With the bypass capacitor added, noise no longer scales with output voltage so that improvements are more dramatic at higher output voltages.

## TYPICAL APPLICATIONS

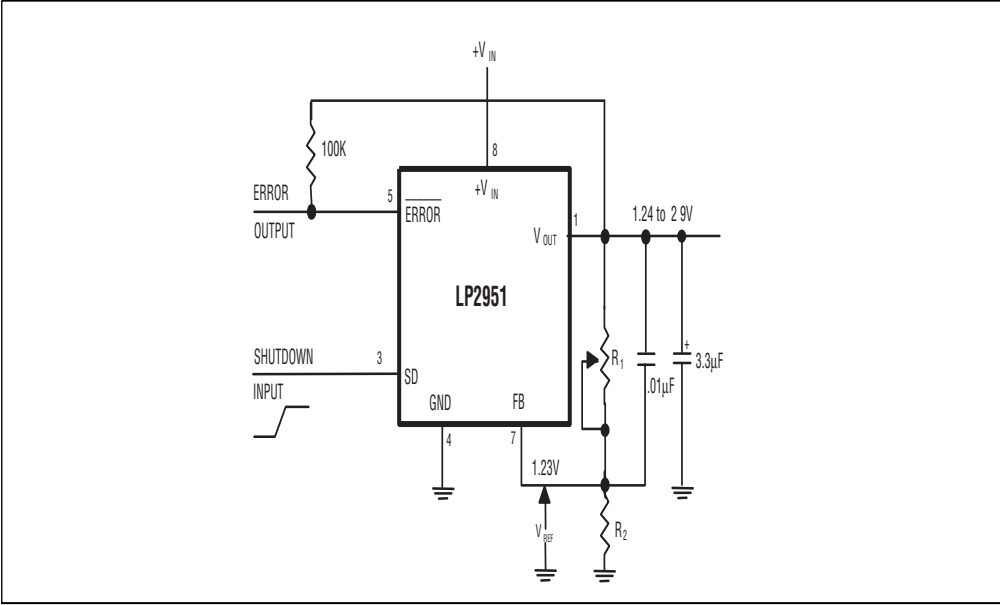

Figure 2. Adjustable Regulator

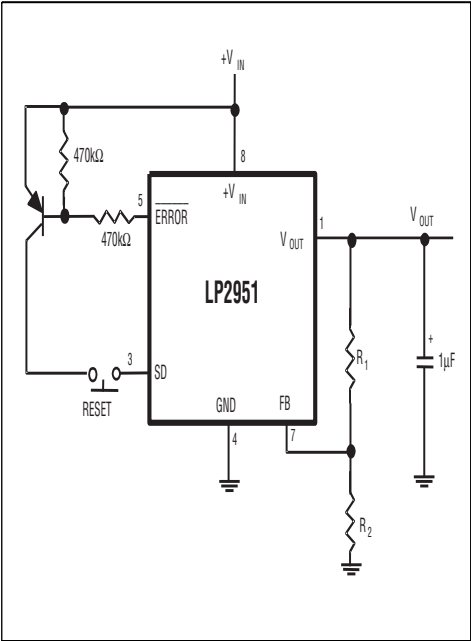

Figure 3. Latch Off When Error Flag Occurs

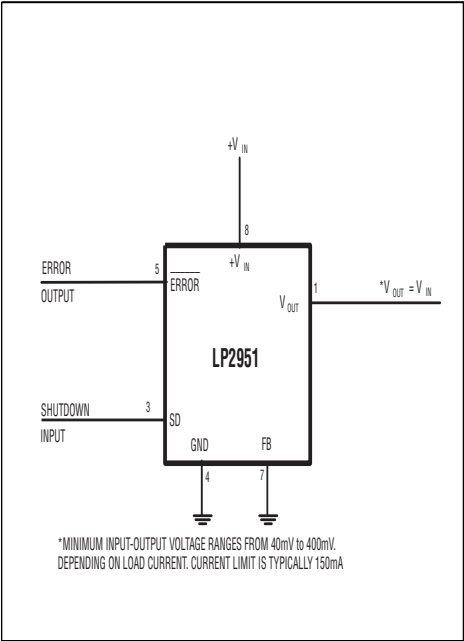

Figure 4. Wide Input voltage Range Current Limiter

## TYPICAL APPLICATIONS (continued)

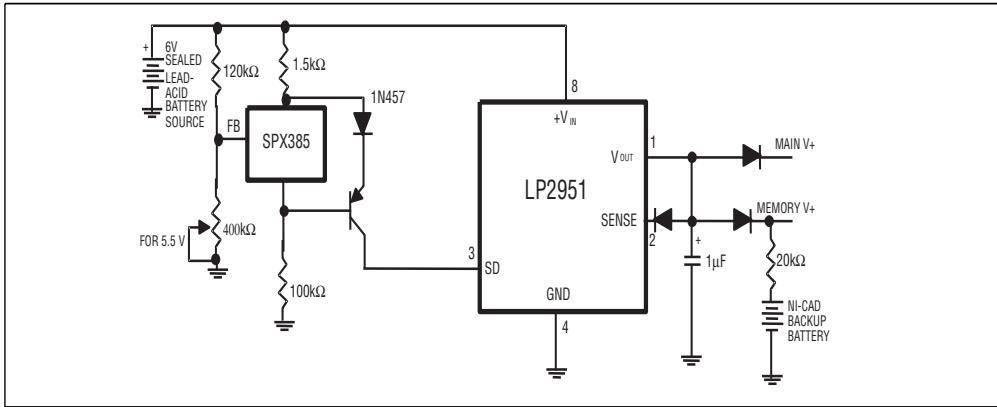

Figure 5. Low Battery disconnect

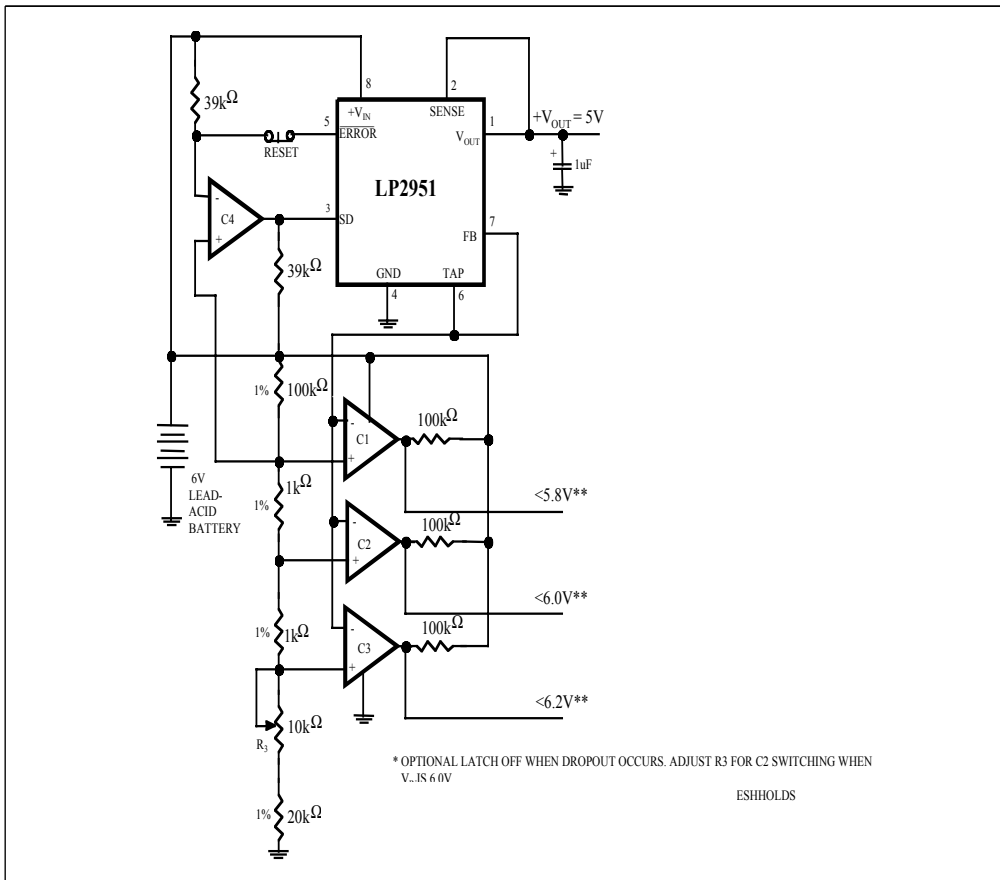
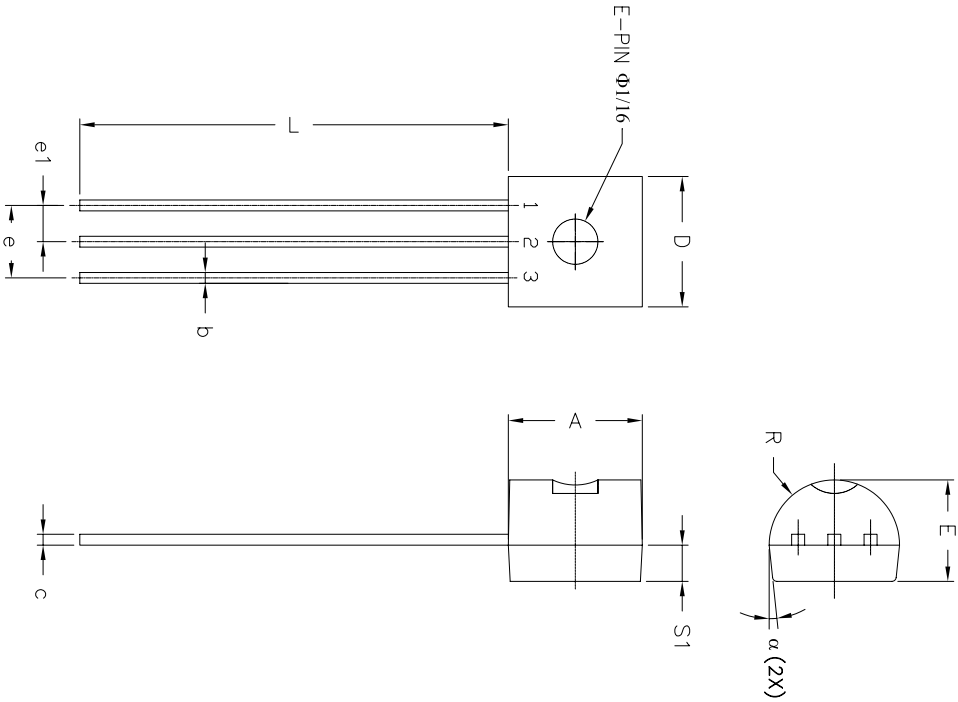

Figure 6. Regulator with State-of-Charge Indicator





3 Pin TO-92 (Option 1)* JEDEC TO-226-AA					
SYMBOLS	DIMENSIONS IN INCH (Control Unit)		DIMENSIONS IN MM (Reference Unit)		
	MIN	MAX	MIN	MAX	
A	0.170	0.210	4.32	5.33	
b	0.014	0.020	0.36	0.51	
c	0.016	0.022	0.41	0.55	
D	0.175	0.205	4.45	5.20	
E	0.125	0.165	3.18	4.19	
e	0.095	0.105	2.42	2.66	
e1	0.045	0.055	1.15	1.39	
L	0.500	0.610	12.70	15.49	
R	0.045	0.095	2.16	2.41	
S1	0.045	0.060	1.14	1.52	
α	4°	6°	4°	6°	
N	3		3		

\* Refer to product datasheet for POD option being used

REVISION HISTORY			
REV.	DESCRIPTION	DATE	APP'D
A	DRAWING ORIGINATION	09/23/05	JL
B	DRAWING FORMAT MODIFICATION	06/15/06	JL
C	CHANGE DRAWING LOGO AND COMPANY NAME	11/28/07	JL

		<b>EXAR CORPORATION</b>	
Packaging Approval:	By: JL	Drawing No:	3 PIN TO-92 PACKAGE OUTLINE
Date: 11/28/07		Revision:	C
		Sheet:	1 OF 2

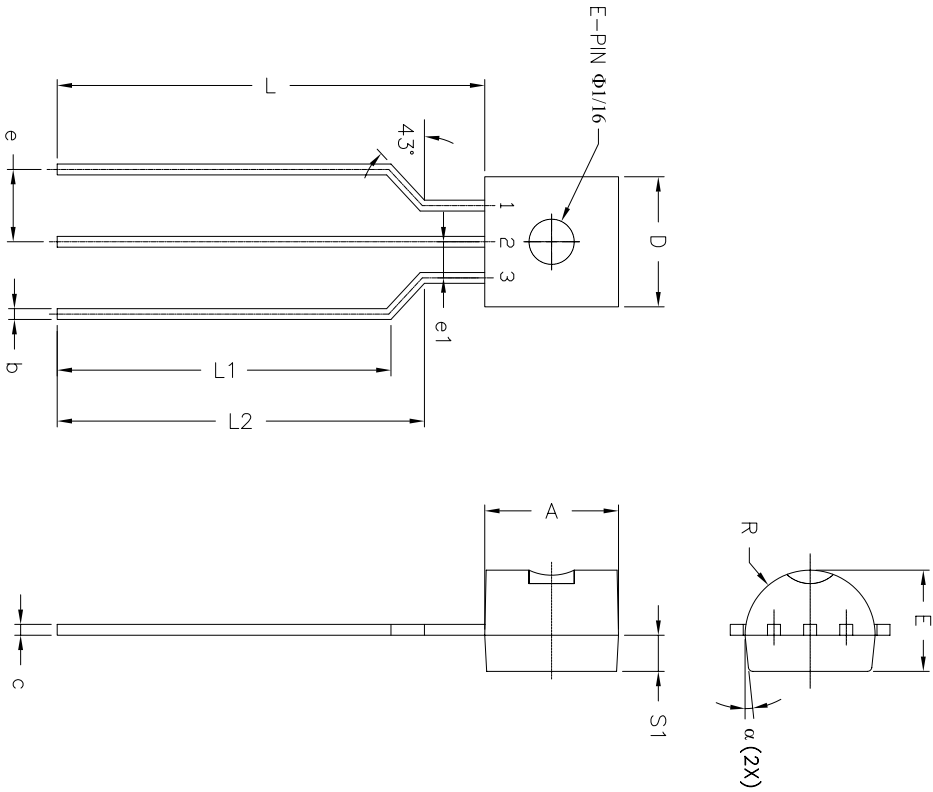

3 Pin TO-92 (Option 2)*					
SYMBOLS	DIMENSIONS IN INCH (Control Unit)		DIMENSIONS IN MM (Reference Unit)		
	MIN	MAX	MIN	MAX	MAX
A	0.170	0.210	4.32	5.33	
b	0.014	0.020	0.36	0.51	
c	0.016	0.022	0.41	0.55	
D	0.175	0.205	4.45	5.20	
E	0.125	0.165	3.18	4.19	
e	0.095	0.105	2.42	2.66	
e1	0.045	0.055	1.15	1.39	
L	0.525		13.34		
L1	0.404		10.26		
L2	0.451		11.46		
R	0.045	0.095	2.16	2.41	
S1	0.045	0.060	1.14	1.52	
alpha	4°	6°	4°	6°	
N	3		3		

\* Refer to product datasheet for P0D option being used

REVISION HISTORY				
REV.	DESCRIPTION	DATE	APP'D	
A	DRAWING ORIGINATOR	12/11/06	JL	
B	ADD LEADS BENDING DIMENSIONS	07/29/07	JL	
C	CHANGE DRAWING LOGO AND COMPANY NAME	11/28/07	JL	

		<b>EXAR CORPORATION</b>	
Packaging Approval:		Drawing No:	
By: JL	Date: 11/28/07	3 PIN TO-92 PACKAGE OUTLINE	3-PIN TO-92
		Revision: C	Sheet: 2 OF 2

REVISION HISTORY		DATE	APP'D
REV.	DESCRIPTION		
A	DRAWING ORIGINATION	08/16/05	JL
B	DRAWING FORMAT MODIFICATION	07/19/06	JL
C	CHANGE DRAWING LOGO AND COMPANY NAME	11/16/07	JL

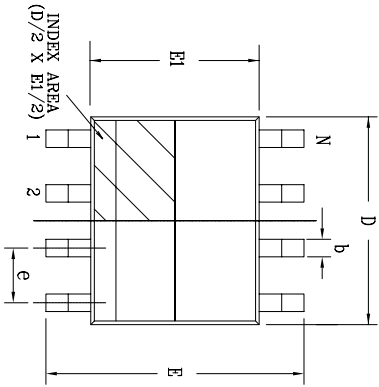

Top View

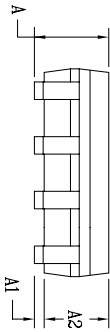

Side View

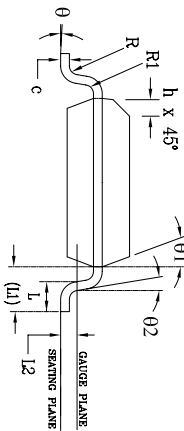

Front View

8 Pin SOICN		JEDEC MS-012		Variation AA		
SYMBOLS	DIMENSIONS IN MM (Control Unit)			DIMENSIONS IN INCH (Reference Unit)		
	MIN.	NOM.	MAX.	MIN.	NOM.	MAX.
A	1.35	—	1.75	0.053	—	0.069
A1	0.10	—	0.25	0.004	—	0.010
A2	1.25	—	1.65	0.049	—	0.065
b	0.31	—	0.51	0.012	—	0.020
c	0.17	—	0.25	0.007	—	0.010
E	—	6.00 BSC	—	—	0.236 BSC	—
E1	—	3.90 BSC	—	—	0.154 BSC	—
e	—	1.27 BSC	—	—	0.050 BSC	—
h	0.25	—	0.50	0.010	—	0.020
L	0.40	—	1.27	0.016	—	0.050
L1	—	1.04 REF	—	—	0.041 REF	—
L2	—	0.25 BSC	—	—	0.010 BSC	—
R	0.07	—	—	0.003	—	—
R1	0.07	—	—	0.003	—	—
θ	0°	—	8°	0°	—	8°
01	5°	—	15°	5°	—	15°
02	0°	—	—	0°	—	—
D	—	4.90 BSC	—	—	0.193 BSC	—
N	—	8	—	—	8	—

		<b>EXAR CORPORATION</b> Powering Connectivity	
Packaging Approvdi:		Drawing No.:	
By: JL		Date: 11/16/07	
Revision: C		Sheet: 1 OF 1	
8 PIN SOICN PACKAGE OUTLINE		8-PIN SOICN	

Part Number	Accuracy	Output Voltage	Package	Shipping	Status
LP2950ACN-L-3-3	0.50%	3.3V	Lead Free 3 Pin TO-92	Bulk	Active
LP2950ACN-L-3-3/TR	0.50%	3.3V	Lead Free 3 Pin TO-92	Tape & Reel	Active
LP2950ACN-L-5-0	0.50%	5.0V	Lead Free 3 Pin TO-92	Bulk	Active
LP2950ACN-L-5-0/TR	0.50%	5.0V	Lead Free 3 Pin TO-92	Tape & Reel	Active
LP2950CN-L-3-3	1%	3.3V	Lead Free 3 Pin TO-92	Bulk	Active
LP2950CN-L-3-3/TR	1%	3.3V	Lead Free 3 Pin TO-92	Tape & Reel	Active
LP2950CN-L-5-0	1%	5.0V	Lead Free 3 Pin TO-92	Bulk	Active
LP2950CN-L-5-0/TR	1%	5.0V	Lead Free 3 Pin TO-92	Tape & Reel	Active
LP2951ACS-L-3-3	0.50%	3.3V	Lead Free 8 Pin SOIC	Bulk	Active
LP2951ACS-L-3-3/TR	0.50%	3.3V	Lead Free 8 Pin SOIC	Tape & Reel	Active
LP2951ACS-L-5-0	0.50%	5.0V/ADJ	Lead Free 8 Pin SOIC	Bulk	Active
LP2951ACS-L-5-0/TR	0.50%	5.0V/ADJ	Lead Free 8 Pin SOIC	Tape & Reel	Active
LP2951CS-L-3-3	1%	3.3V	Lead Free 8 Pin SOIC	Bulk	Active
LP2951CS-L-3-3/TR	1%	3.3V	Lead Free 8 Pin SOIC	Tape & Reel	Active
LP2951CS-L-5-0	1%	5.0V/ADJ	Lead Free 8 Pin SOIC	Bulk	Active
LP2951CS-L-5-0/TR	1%	5.0V/ADJ	Lead Free 8 Pin SOIC	Tape & Reel	Active

Part Number	Accuracy	Output Voltage	Package	Shipping	Status
LP2950ACN-3-3	0.50%	3.3V	3 Pin TO-92	Bulk	EOL
LP2950ACN-5-0	0.50%	5.0V	3 Pin TO-92	Bulk	EOL
LP2950CN-3-3	1%	3.3V	3 Pin TO-92	Bulk	EOL
LP2950CN-3-3/TR	1%	3.3V	3 Pin TO-92	Tape & Reel	EOL
LP2950CN-5-0	1%	5.0V	3 Pin TO-92	Bulk	EOL
LP2950CN-5-0/TR	1%	5.0V	3 Pin TO-92	Tape & Reel	EOL
LP2951ACS-3-3	0.50%	3.3V	8 Pin SOIC	Bulk	EOL
LP2951ACS-5-0	0.50%	5.0V/ADJ	8 Pin SOIC	Bulk	EOL
LP2951CS-3-3	1%	3.3V	8 Pin SOIC	Bulk	EOL
LP2951CS-3-3/TR	1%	3.3V	8 Pin SOIC	Tape & Reel	EOL
LP2951CS-5-0	1%	5.0V/ADJ	8 Pin SOIC	Bulk	EOL
LP2951CS-5-0/TR	1%	5.0V/ADJ	8 Pin SOIC	Tape & Reel	EOL
LP2950ACN-3-3/TR	0.50%	3.3V	3 Pin TO-92	Tape & Reel	OBS
LP2950ACN-5-0/TR	0.50%	5.0V	3 Pin TO-92	Tape & Reel	OBS
LP2951ACS-3-3/TR	0.50%	3.3V	8 Pin SOIC	Tape & Reel	OBS
LP2951ACS-5-0/TR	0.50%	5.0V/ADJ	8 Pin SOIC	Tape & Reel	OBS



**Exar Corporation**  
**Headquarters and**  
**Sales Office**  
 48720 Kato Road  
 Fremont, CA 94538  
 main: 510-668-7000  
 fax: 510-668-7030

EXAR Corporation reserves the right to make changes to the products contained in this publication in order to improve design, performance or reliability. EXAR Corporation assumes no responsibility for the use of any circuits described herein, conveys no license under any patent or other right, and makes no representation that the circuits are free of patent infringement. Charts and schedules contained here in are only for illustration purposes and may vary depending upon a user's specific application. While the information in this publication has been carefully checked; no responsibility, however, is assumed for inaccuracies.

EXAR Corporation does not recommend the use of any of its products in life support applications where the failure or malfunction of the product can reasonably be expected to cause failure of the life support system or to significantly affect its safety or effectiveness. Products are not authorized for use in such applications unless EXAR Corporation receives, in writing, assurances to its satisfaction that: (a) the risk of injury or damage has been minimized; (b) the user assumes all such risks; (c) potential liability of EXAR Corporation is adequately protected under the circumstances.



The content of this document is furnished for informational use only, is subject to change without notice, and should not be construed as a commitment by MaxLinear, Inc.. MaxLinear, Inc. assumes no responsibility or liability for any errors or inaccuracies that may appear in the informational content contained in this guide. Complying with all applicable copyright laws is the responsibility of the user. Without limiting the rights under copyright, no part of this document may be reproduced into, stored in, or introduced into a retrieval system, or transmitted in any form or by any means (electronic, mechanical, photocopying, recording, or otherwise), or for any purpose, without the express written permission of MaxLinear, Inc.

Maxlinear, Inc. does not recommend the use of any of its products in life support applications where the failure or malfunction of the product can reasonably be expected to cause failure of the life support system or to significantly affect its safety or effectiveness. Products are not authorized for use in such applications unless MaxLinear, Inc. receives, in writing, assurances to its satisfaction that: (a) the risk of injury or damage has been minimized; (b) the user assumes all such risks; (c) potential liability of

MaxLinear, Inc. is adequately protected under the circumstances.

MaxLinear, Inc. may have patents, patent applications, trademarks, copyrights, or other intellectual property rights covering subject matter in this document. Except as expressly provided in any written license agreement from MaxLinear, Inc., the furnishing of this document does not give you any license to these patents, trademarks, copyrights, or other intellectual property.

Company and product names may be registered trademarks or trademarks of the respective owners with which they are associated.

© 2017 MaxLinear, Inc. All rights reserved

---

## Looking for pricing, stock, or lifecycle information?

Click below to explore more details on WIN SOURCE:

 [View LP2951CS-L-5-0/TR on WIN SOURCE](#)

 [Exar Corporation](#) Information

## Optimize Your Supply Chain with WIN SOURCE Solutions

-  Global Sourcing Solution
-  Obsolete Management
-  Cost Control Management
-  Shortage Management
-  Alternative Solution
-  Excess Inventory Management