



**THE DATASHEET OF
MB95F274KPF-G-SNE2**





The following document contains information on Cypress products. The document has the series name, product name, and ordering part numbering with the prefix “MB”. However, Cypress will offer these products to new and existing customers with the series name, product name, and ordering part number with the prefix “CY”.

How to Check the Ordering Part Number

1. Go to www.cypress.com/pcn.
2. Enter the keyword (for example, ordering part number) in the **SEARCH PCNS** field and click **Apply**.
3. Click the corresponding title from the search results.
4. Download the Affected Parts List file, which has details of all changes

For More Information

Please contact your local sales office for additional information about Cypress products and solutions.

About Cypress

Cypress is the leader in advanced embedded system solutions for the world's most innovative automotive, industrial, smart home appliances, consumer electronics and medical products. Cypress' microcontrollers, analog ICs, wireless and USB-based connectivity solutions and reliable, high-performance memories help engineers design differentiated products and get them to market first. Cypress is committed to providing customers with the best support and development resources on the planet enabling them to disrupt markets by creating new product categories in record time. To learn more, go to www.cypress.com.



MB95260H/270H/280H are series of general-purpose, single-chip microcontrollers. In addition to a compact instruction set, the microcontrollers of these series contain a variety of peripheral resources.

Features

F²MC-8FX CPU core

Instruction set optimized for controllers

- Multiplication and division instructions
- 16-bit arithmetic operations
- Bit test branch instructions
- Bit manipulation instructions, etc.

Clock (main OSC clock and sub-OSC clock are only available on MB95F262H/F262K/F263H/F263K/F264H/F264K/F282H/F282K/F283H/F283K/F284H/F284K)

- Selectable main clock source
 - Main OSC clock (up to 16.25 MHz, maximum machine clock frequency: 8.125 MHz)
 - External clock (up to 32.5 MHz, maximum machine clock frequency: 16.25 MHz)
 - Main CR clock (1/8/10 MHz \pm 3%, maximum machine clock frequency: 10 MHz)
- Selectable subclock source
 - Sub-OSC clock (32.768 kHz)
 - External clock (32.768 kHz)
 - Sub CR clock (Typ: 100 kHz, Min: 50 kHz, Max: 200 kHz)

Timer

- 8/16-bit composite timer
- Time-base timer
- Watch prescaler

LIN-UART (only available on MB95F262H/F262K/F263H/F263K/F264H/F264K/F282H/F282K/F283H/F283K/F284H/F284K)

- Full duplex double buffer
- Capable of clock-synchronized serial data transfer and clock-asynchronous serial data transfer

External interrupt

- Interrupt by edge detection (rising edge, falling edge, and both edges can be selected)
- Can be used to wake up the device from different low power consumption (standby) modes

8/10-bit A/D converter

- 8-bit or 10-bit resolution can be selected.

Low power consumption (standby) modes

- Stop mode
- Sleep mode
- Watch mode
- Time-base timer mode

I/O port (Max: 17) (MB95F262K/F263K/F264K)

- General-purpose I/O ports (Max):
CMOS I/O: 15, N-ch open drain: 2

I/O port (Max: 16) (MB95F262H/F263H/F264H)

- General-purpose I/O ports (Max):
CMOS I/O: 15, N-ch open drain: 1

I/O port (Max: 5) (MB95F272K/F273K/F274K)

- General-purpose I/O ports (Max):
CMOS I/O: 3, N-ch open drain: 2

I/O port (Max: 4) (MB95F272H/F273H/F274H)

- General-purpose I/O ports (Max):
CMOS I/O: 3, N-ch open drain: 1

I/O port (Max: 13) (MB95F282K/F283K/F284K)

- General-purpose I/O ports (Max):
CMOS I/O: 11, N-ch open drain: 2

I/O port (Max: 12) (MB95F282H/F283H/F284H)

- General-purpose I/O ports (Max):
CMOS I/O: 11, N-ch open drain: 1

On-chip debug

- 1-wire serial control
- Serial writing supported (asynchronous mode)

Hardware/software watchdog timer

- Built-in hardware watchdog timer
- Built-in software watchdog timer

Power-on reset

- A power-on reset is generated when the power is switched on.

Low-voltage detection reset circuit

- Built-in low-voltage detector

Clock supervisor counter

- Built-in clock supervisor counter function

Programmable port input voltage level

- CMOS input level / hysteresis input level

Dual operation Flash memory

- The program/erase operation and the read operation can be executed in different banks (upper bank/lower bank) simultaneously.

Flash memory security function

- Protects the content of the Flash memory

Contents

Product Line-up	4	I/O Map (MB95260H Series)	32
Packages and Corresponding Products	9	I/O Map (MB95270H Series)	36
Differences among Products and Note on Product Selection	10	I/O Map (MB95280H Series)	40
Pin Assignment	11	Interrupt Source Table (MB95260H Series)	44
Pin Description (MB95260H Series, 32 pins)	13	Interrupt Source Table (MB95270H Series)	45
Pin Description (MB95260H Series, 24 pins)	15	Interrupt Source Table (MB95280H Series)	46
Pin Description (MB95260H Series, 20 pins)	17	Electrical Characteristics	47
Pin Description (MB95270H Series, 8 pins)	19	Absolute Maximum Ratings	47
Pin Description (MB95280H Series, 32 pins)	20	Recommended Operating Conditions	49
Pin Description (MB95280H Series, 16 pins)	22	DC Characteristics	50
I/O Circuit Type	24	AC Characteristics	53
Notes on Device Handling	26	A/D Converter	68
Pin Connection	26	Flash Memory Program/Erase Characteristics	72
Block Diagram (MB95260H Series)	28	Sample Characteristics	73
Block Diagram (MB95270H Series)	29	Mask Options	79
Block Diagram (MB95280H Series)	30	Ordering Information	80
CPU Core	31	Package Dimension	82
		Major Changes	90
		Document History	91

1. Product Line-up

MB95260H Series

Part number	MB95F262H	MB95F263H	MB95F264H	MB95F262K	MB95F263K	MB95F264K
Type	Flash memory product					
Clock supervisor counter	It supervises the main clock oscillation.					
Flash memory capacity	8 Kbyte	12 Kbyte	20 Kbyte	8 Kbyte	12 Kbyte	20 Kbyte
RAM capacity	240 bytes	496 bytes	496 bytes	240 bytes	496 bytes	496 bytes
Power-on reset	Yes					
Low-voltage detection reset	No			Yes		
Reset input	Dedicated			Selected by software		
CPU functions	<ul style="list-style-type: none"> • Number of basic instructions : 136 • Instruction bit length : 8 bits • Instruction length : 1 to 3 bytes • Data bit length : 1, 8 and 16 bits • Minimum instruction execution time : 61.5 ns (machine clock frequency = 16.25 MHz) • Interrupt processing time : 0.6 μs (machine clock frequency = 16.25 MHz) 					
General-purpose I/O	<ul style="list-style-type: none"> • I/O ports (Max) : 16 • CMOS I/O : 15 • N-ch open drain : 1 			<ul style="list-style-type: none"> • I/O ports (Max) : 17 • CMOS I/O : 15 • N-ch open drain : 2 		
Time-base timer	Interval time: 0.256 ms to 8.3 s (external clock frequency = 4 MHz)					
Hardware/software watchdog timer	<ul style="list-style-type: none"> • Reset generation cycle Main oscillation clock at 10 MHz: 105 ms (Min) • The sub CR clock can be used as the source clock of the hardware watchdog timer. 					
Wild register	It can be used to replace three bytes of data.					
LIN-UART	<ul style="list-style-type: none"> • A wide range of communication speed can be selected by a dedicated reload timer. • It has a full duplex double buffer. • Clock-synchronized serial data transfer and clock-asynchronized serial data transfer is enabled. • The LIN function can be used as a LIN master or a LIN slave. 					
8/10-bit A/D converter	6 channels 8-bit or 10-bit resolution can be selected.					
8/16-bit composite timer	2 channels <ul style="list-style-type: none"> • The timer can be configured as an "8-bit timer \times 2 channels" or a "16-bit timer \times 1 channel". • It has built-in timer function, PWC function, PWM function and input capture function. • Count clock: it can be selected from internal clocks (seven types) and external clocks. • It can output square wave. 					
External interrupt	6 channels <ul style="list-style-type: none"> • Interrupt by edge detection (The rising edge, falling edge, or both edges can be selected.) • It can be used to wake up the device from the standby mode. 					
On-chip debug	<ul style="list-style-type: none"> • 1-wire serial control • It supports serial writing. (asynchronous mode) 					

(Continued)

(Continued)

Part number	MB95F262H	MB95F263H	MB95F264H	MB95F262K	MB95F263K	MB95F264K
Parameter						
Watch prescaler	Eight different time intervals can be selected.					
Flash memory	<ul style="list-style-type: none"> • It supports automatic programming, Embedded Algorithm, program/erase/erase-suspend/erase-resume commands. • It has a flag indicating the completion of the operation of Embedded Algorithm. • Number of program/erase cycles: 100000 • Data retention time: 20 years • Flash security feature for protecting the content of the Flash memory 					
Standby mode	Sleep mode, stop mode, watch mode, time-base timer mode					
Package	DIP-24P-M07 LCC-32P-M19 FPT-20P-M09 FPT-20P-M10					

MB95270H Series

Part number	MB95F272H	MB95F273H	MB95F274H	MB95F272K	MB95F273K	MB95F274K
Parameter						
Type	Flash memory product					
Clock supervisor counter	It supervises the main clock oscillation.					
Flash memory capacity	8 Kbyte	12 Kbyte	20 Kbyte	8 Kbyte	12 Kbyte	20 Kbyte
RAM capacity	240 bytes	496 bytes	496 bytes	240 bytes	496 bytes	496 bytes
Power-on reset	Yes					
Low-voltage detection reset	No			Yes		
Reset input	Dedicated			Selected by software		
CPU functions	<ul style="list-style-type: none"> • Number of basic instructions : 136 • Instruction bit length : 8 bits • Instruction length : 1 to 3 bytes • Data bit length : 1, 8 and 16 bits • Minimum instruction execution time : 61.5 ns (machine clock frequency = 16.25 MHz) • Interrupt processing time : 0.6 μs (machine clock frequency = 16.25 MHz) 					
General-purpose I/O	<ul style="list-style-type: none"> • I/O ports (Max) : 4 • CMOS I/O : 3 • N-ch open drain : 1 			<ul style="list-style-type: none"> • I/O ports (Max) : 5 • CMOS I/O : 3 • N-ch open drain : 2 		
Time-base timer	Interval time: 0.256 ms to 8.3 s (external clock frequency = 4 MHz)					
Hardware/software watchdog timer	<ul style="list-style-type: none"> • Reset generation cycle Main oscillation clock at 10 MHz: 105 ms (Min) • The sub-internal CR clock can be used as the source clock of the hardware watchdog timer. 					
Wild register	It can be used to replace three bytes of data.					
LIN-UART	No LIN-UART					
8/10-bit A/D converter	2 channels 8-bit or 10-bit resolution can be selected.					
8/16-bit composite timer	1 channel <ul style="list-style-type: none"> • The timer can be configured as an "8-bit timer × 2 channels" or a "16-bit timer × 1 channel". • It has built-in timer function, PWC function, PWM function and input capture function. • Count clock: it can be selected from internal clocks (seven types) and external clocks. • It can output square wave. 					
External interrupt	2 channels <ul style="list-style-type: none"> • Interrupt by edge detection (The rising edge, falling edge, or both edges can be selected.) • It can be used to wake up the device from standby modes. 					
On-chip debug	<ul style="list-style-type: none"> • 1-wire serial control • It supports serial writing. (asynchronous mode) 					
Watch prescaler	Eight different time intervals can be selected.					
Flash memory	<ul style="list-style-type: none"> • It supports automatic programming, Embedded Algorithm, program/erase/erase-suspend/erase-resume commands. • It has a flag indicating the completion of the operation of Embedded Algorithm. • Number of program/erase cycles: 100000 • Data retention time: 20 years • Flash security feature for protecting the content of the Flash memory 					
Standby mode	Sleep mode, stop mode, watch mode, time-base timer mode					
Package	DIP-8P-M03 FPT-8P-M08					

MB95280H Series

Part number	MB95F282H	MB95F283H	MB95F284H	MB95F282K	MB95F283K	MB95F284K
Parameter						
Type	Flash memory product					
Clock supervisor counter	It supervises the main clock oscillation.					
Flash memory capacity	8 Kbyte	12 Kbyte	20 Kbyte	8 Kbyte	12 Kbyte	20 Kbyte
RAM capacity	240 bytes	496 bytes	496 bytes	240 bytes	496 bytes	496 bytes
Power-on reset	Yes					
Low-voltage detection reset	No			Yes		
Reset input	Dedicated			Selected by software		
CPU functions	<ul style="list-style-type: none"> • Number of basic instructions : 136 • Instruction bit length : 8 bits • Instruction length : 1 to 3 bytes • Data bit length : 1, 8 and 16 bits • Minimum instruction execution time : 61.5 ns (machine clock frequency = 16.25 MHz) • Interrupt processing time : 0.6 μs (machine clock frequency = 16.25 MHz) 					
General-purpose I/O	<ul style="list-style-type: none"> • I/O ports (Max) : 12 • CMOS I/O : 11 • N-ch open drain : 1 			<ul style="list-style-type: none"> • I/O ports (Max) : 13 • CMOS I/O : 11 • N-ch open drain : 2 		
Time-base timer	Interval time: 0.256 ms to 8.3 s (external clock frequency = 4 MHz)					
Hardware/software watchdog timer	<ul style="list-style-type: none"> • Reset generation cycle Main oscillation clock at 10 MHz: 105 ms (Min) • The sub-internal CR clock can be used as the source clock of the hardware watchdog timer. 					
Wild register	It can be used to replace three bytes of data.					
LIN-UART	<ul style="list-style-type: none"> • A wide range of communication speed can be selected by a dedicated reload timer. • It has a full duplex double buffer. • Clock-synchronized serial data transfer and clock-asynchronized serial data transfer is enabled. • The LIN function can be used as a LIN master or a LIN slave. 					
8/10-bit A/D converter	5 channels					
	8-bit or 10-bit resolution can be selected.					
8/16-bit composite timer	1 channel					
	<ul style="list-style-type: none"> • The timer can be configured as an "8-bit timer × 2 channels" or a "16-bit timer × 1 channel". • It has built-in timer function, PWC function, PWM function and input capture function. • Count clock: it can be selected from internal clocks (seven types) and external clocks. • It can output square wave. 					
External interrupt	6 channels					
	<ul style="list-style-type: none"> • Interrupt by edge detection (The rising edge, falling edge, or both edges can be selected.) • It can be used to wake up the device from standby modes. 					
On-chip debug	<ul style="list-style-type: none"> • 1-wire serial control • It supports serial writing. (asynchronous mode) 					

(Continued)

(Continued)

Part number	MB95F282H	MB95F283H	MB95F284H	MB95F282K	MB95F283K	MB95F284K
Parameter						
Watch prescaler	Eight different time intervals can be selected.					
Flash memory	<ul style="list-style-type: none"> • It supports automatic programming, Embedded Algorithm, program/erase/erase-suspend/erase-resume commands. • It has a flag indicating the completion of the operation of Embedded Algorithm. • Number of program/erase cycles: 100000 • Data retention time: 20 years • Flash security feature for protecting the content of the Flash memory 					
Standby mode	Sleep mode, stop mode, watch mode, time-base timer mode					
Package	LCC-32P-M19 DIP-16P-M06 FPT-16P-M06					

2. Packages and Corresponding Products

Part number Package	MB95F2	MB95F2	MB95F2	MB95F2	MB95F2	MB95F2	MB95F2	MB95F2	MB95F2	MB95F2	MB95F2	MB95F2
	62H	62K	63H	63K	64H	64K	72H	72K	73H	73K	74H	74K
DIP-24P-M07	O	O	O	O	O	O	X	X	X	X	X	X
FPT-20P-M09	O	O	O	O	O	O	X	X	X	X	X	X
FPT-20P-M10	O	O	O	O	O	O	X	X	X	X	X	X
DIP-16P-M06	X	X	X	X	X	X	X	X	X	X	X	X
FPT-16P-M06	X	X	X	X	X	X	X	X	X	X	X	X
DIP-8P-M03	X	X	X	X	X	X	O	O	O	O	O	O
FPT-8P-M08	X	X	X	X	X	X	O	O	O	O	O	O
LCC-32P-M19	O	O	O	O	O	O	X	X	X	X	X	X

Part number Package	MB95F282H	MB95F282K	MB95F283H	MB95F283K	MB95F284H	MB95F284K
	DIP-24P-M07	X	X	X	X	X
FPT-20P-M09	X	X	X	X	X	X
FPT-20P-M10	X	X	X	X	X	X
DIP-16P-M06	O	O	O	O	O	O
FPT-16P-M06	O	O	O	O	O	O
DIP-8P-M03	X	X	X	X	X	X
FPT-8P-M08	X	X	X	X	X	X
LCC-32P-M19	O	O	O	O	O	O

O: Available

X: Unavailable

3. Differences among Products and Notes on Product Selection

Current consumption

When using the on-chip debug function, take account of the current consumption of flash erase/write.

For details of current consumption, see “24. Electrical Characteristics”.

Package

For details of information on each package, see “2. Packages and Corresponding Products” and “28. Package Dimension”.

Operating voltage

The operating voltage varies, depending on whether the on-chip debug function is used or not.

For details of the operating voltage, see “24. Electrical Characteristics”.

On-chip debug function

The on-chip debug function requires that V_{CC} , V_{SS} and 1 serial-wire be connected to an evaluation tool. In addition, if the Flash memory data has to be updated, the PF2/RST pin must also be connected to the same evaluation tool.

4. Pin Assignment

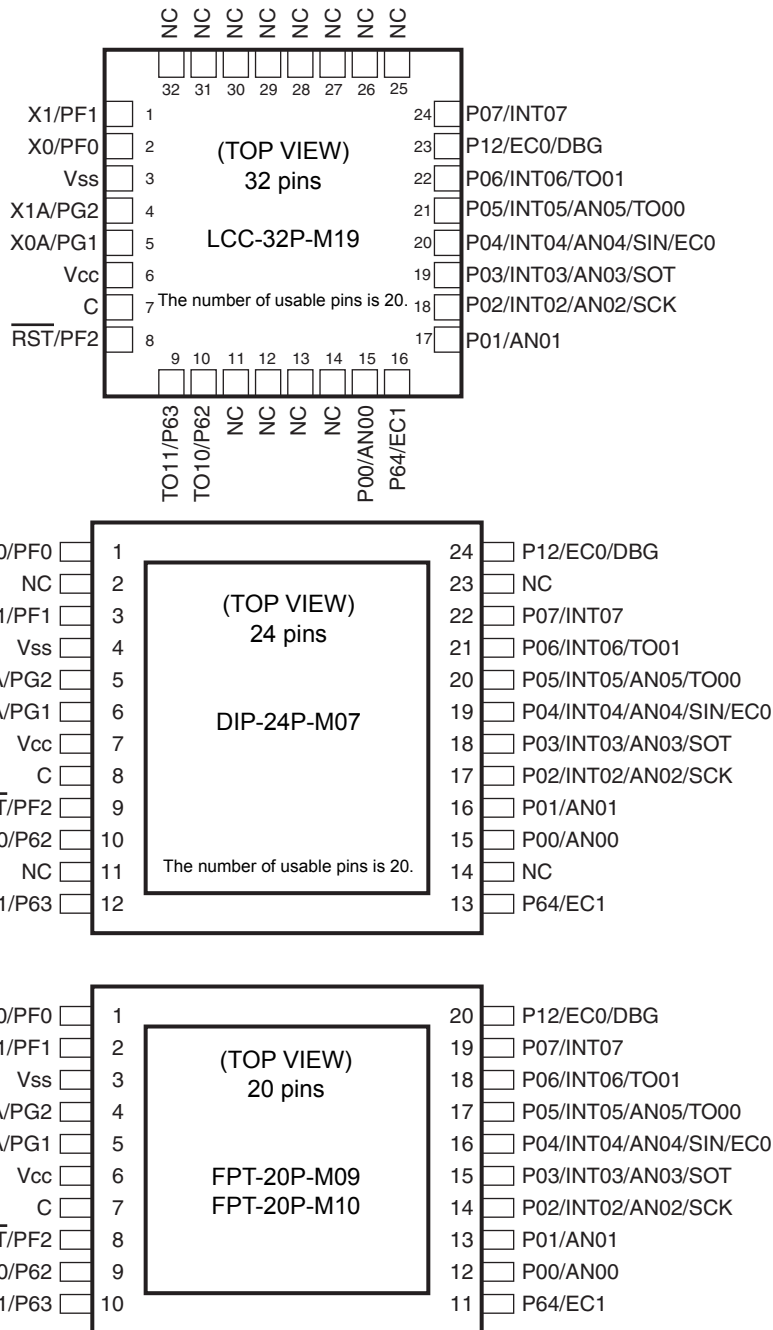

(Continued)

(Continued)

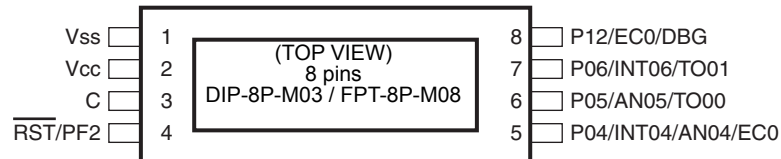
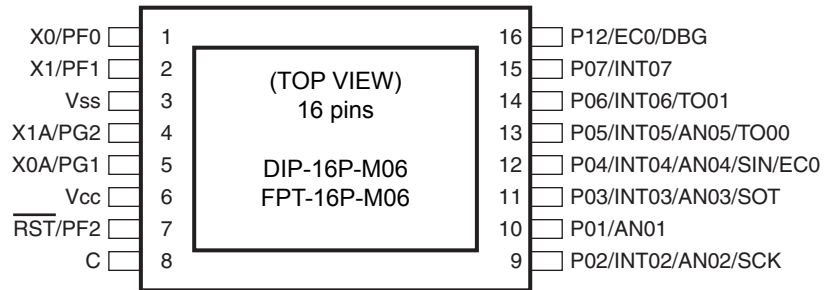
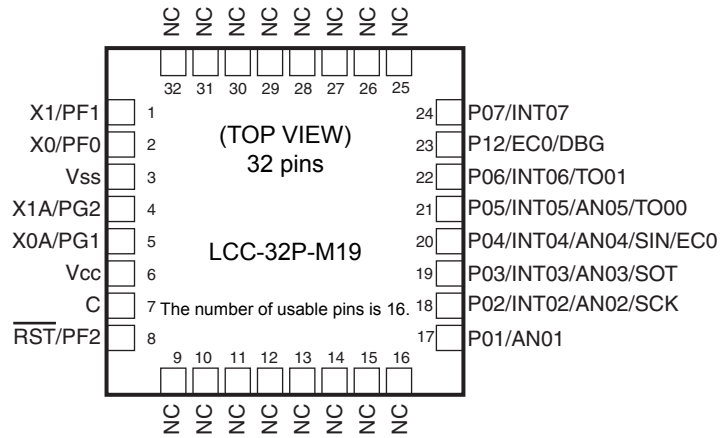

5. Pin Description (MB95260H Series, 32 pins)

Pin no.	Pin name	I/O circuit type*	Function
1	PF1	B	General-purpose I/O port
	X1		Main clock I/O oscillation pin
2	PF0	B	General-purpose I/O port
	X0		Main clock input oscillation pin
3	Vss	—	Power supply pin (GND)
4	PG2	C	General-purpose I/O port
	X1A		Subclock I/O oscillation pin
5	PG1	C	General-purpose I/O port
	X0A		Subclock input oscillation pin
6	Vcc	—	Power supply pin
7	C	—	Capacitor connection pin
8	PF2	A	General-purpose I/O port
	$\overline{\text{RST}}$		Reset pin This is a dedicated reset pin in MB95F262H/F263H/F264H.
9	P63	D	General-purpose I/O port High-current pin
	TO11		8/16-bit composite timer ch. 1 output pin
10	P62	D	General-purpose I/O port High-current pin
	TO10		8/16-bit composite timer ch. 1 output pin
11	NC	—	It is an internally connected pin. Always leave it unconnected.
12	NC	—	It is an internally connected pin. Always leave it unconnected.
13	NC	—	It is an internally connected pin. Always leave it unconnected.
14	NC	—	It is an internally connected pin. Always leave it unconnected.
15	P00	E	General-purpose I/O port
	AN00		A/D converter analog input pin
16	P64	D	General-purpose I/O port
	EC1		8/16-bit composite timer ch. 1 clock input pin
17	P01	E	General-purpose I/O port
	AN01		A/D converter analog input pin
18	P02	E	General-purpose I/O port
	INT02		External interrupt input pin
	AN02		A/D converter analog input pin
	SCK		LIN-UART clock I/O pin
19	P03	E	General-purpose I/O port
	INT03		External interrupt input pin
	AN03		A/D converter analog input pin
	SOT		LIN-UART data output pin

(Continued)

(Continued)

Pin no.	Pin name	I/O circuit type*	Function
20	P04	F	General-purpose I/O port
	INT04		External interrupt input pin
	AN04		A/D converter analog input pin
	SIN		LIN-UART data input pin
	EC0		8/16-bit composite timer ch. 0 clock input pin
21	P05	E	General-purpose I/O port High-current pin
	INT05		External interrupt input pin
	AN05		A/D converter analog input pin
	TO00		8/16-bit composite timer ch. 0 output pin
22	P06	G	General-purpose I/O port High-current pin
	INT06		External interrupt input pin
	TO01		8/16-bit composite timer ch. 0 output pin
23	P12	H	General-purpose I/O port
	EC0		8/16-bit composite timer ch. 0 clock input pin
	DBG		DBG input pin
24	P07	G	General-purpose I/O port
	INT07		External interrupt input pin
25	NC	—	It is an internally connected pin. Always leave it unconnected.
26	NC	—	It is an internally connected pin. Always leave it unconnected.
27	NC	—	It is an internally connected pin. Always leave it unconnected.
28	NC	—	It is an internally connected pin. Always leave it unconnected.
29	NC	—	It is an internally connected pin. Always leave it unconnected.
30	NC	—	It is an internally connected pin. Always leave it unconnected.
31	NC	—	It is an internally connected pin. Always leave it unconnected.
32	NC	—	It is an internally connected pin. Always leave it unconnected.

*: For the I/O circuit types, see “11. I/O Circuit Type”.

6. Pin Description (MB95260H Series, 24 pins)

Pin no.	Pin name	I/O circuit type*	Function
1	PF0	B	General-purpose I/O port
	X0		Main clock input oscillation pin
2	NC	—	It is an internally connected pin. Always leave it unconnected.
3	PF1	B	General-purpose I/O port
	X1		Main clock I/O oscillation pin
4	V _{SS}	—	Power supply pin (GND)
5	PG2	C	General-purpose I/O port
	X1A		Subclock I/O oscillation pin
6	PG1	C	General-purpose I/O port
	X0A		Subclock input oscillation pin
7	V _{CC}	—	Power supply pin
8	C	—	Capacitor connection pin
9	PF2	A	General-purpose I/O port
	$\overline{\text{RST}}$		Reset pin This is a dedicated reset pin in MB95F262H/F263H/F264H.
10	P62	D	General-purpose I/O port High-current pin
	TO10		8/16-bit composite timer ch. 1 output pin
11	NC	—	It is an internally connected pin. Always leave it unconnected.
12	P63	D	General-purpose I/O port High-current pin
	TO11		8/16-bit composite timer ch. 1 output pin
13	P64	D	General-purpose I/O port
	EC1		8/16-bit composite timer ch. 1 clock input pin
14	NC	—	It is an internally connected pin. Always leave it unconnected.
15	P00	E	General-purpose I/O port
	AN00		A/D converter analog input pin
16	P01	E	General-purpose I/O port
	AN01		A/D converter analog input pin
17	P02	E	General-purpose I/O port
	INT02		External interrupt input pin
	AN02		A/D converter analog input pin
	SCK		LIN-UART clock I/O pin

(Continued)

(Continued)

Pin no.	Pin name	I/O circuit type*	Function
18	P03	E	General-purpose I/O port
	INT03		External interrupt input pin
	AN03		A/D converter analog input pin
	SOT		LIN-UART data output pin
19	P04	F	General-purpose I/O port
	INT04		External interrupt input pin
	AN04		A/D converter analog input pin
	SIN		LIN-UART data input pin
	EC0		8/16-bit composite timer ch. 0 clock input pin
20	P05	E	General-purpose I/O port High-current pin
	INT05		External interrupt input pin
	AN05		A/D converter analog input pin
	TO00		8/16-bit composite timer ch. 0 output pin
21	P06	G	General-purpose I/O port High-current pin
	INT06		External interrupt input pin
	TO01		8/16-bit composite timer ch. 0 output pin
22	P07	G	General-purpose I/O port
	INT07		External interrupt input pin
23	NC	—	It is an internally connected pin. Always leave it unconnected.
24	P12	H	General-purpose I/O port
	EC0		8/16-bit composite timer ch. 0 clock input pin
	DBG		DBG input pin

*: For the I/O circuit types, see “11. I/O Circuit Type”.

7. Pin Description (MB95260H Series, 20 pins)

Pin no.	Pin name	I/O circuit type*	Function
1	PF0	B	General-purpose I/O port
	X0		Main clock input oscillation pin
2	PF1	B	General-purpose I/O port
	X1		Main clock I/O oscillation pin
3	V _{SS}	—	Power supply pin (GND)
4	PG2	C	General-purpose I/O port
	X1A		Subclock I/O oscillation pin
5	PG1	C	General-purpose I/O port
	X0A		Subclock input oscillation pin
6	V _{CC}	—	Power supply pin
7	C	—	Capacitor connection pin
8	PF2	A	General-purpose I/O port
	$\overline{\text{RST}}$		Reset pin This is a dedicated reset pin in MB95F262H/F263H/F264H.
9	P62	D	General-purpose I/O port High-current pin
	TO10		8/16-bit composite timer ch. 1 output pin
10	P63	D	General-purpose I/O port High-current pin
	TO11		8/16-bit composite timer ch. 1 output pin
11	P64	D	General-purpose I/O port
	EC1		8/16-bit composite timer ch. 1 clock input pin
12	P00	E	General-purpose I/O port
	AN00		A/D converter analog input pin
13	P01	E	General-purpose I/O port
	AN01		A/D converter analog input pin
14	P02	E	General-purpose I/O port
	INT02		External interrupt input pin
	AN02		A/D converter analog input pin
	SCK		LIN-UART clock I/O pin
15	P03	E	General-purpose I/O port
	INT03		External interrupt input pin
	AN03		A/D converter analog input pin
	SOT		LIN-UART data output pin

(Continued)

(Continued)

Pin no.	Pin name	I/O circuit type*	Function
16	P04	F	General-purpose I/O port
	INT04		External interrupt input pin
	AN04		A/D converter analog input pin
	SIN		LIN-UART data input pin
	EC0		8/16-bit composite timer ch. 0 clock input pin
17	P05	E	General-purpose I/O port High-current pin
	INT05		External interrupt input pin
	AN05		A/D converter analog input pin
	TO00		8/16-bit composite timer ch. 0 output pin
18	P06	G	General-purpose I/O port High-current pin
	INT06		External interrupt input pin
	TO01		8/16-bit composite timer ch. 0 output pin
19	P07	G	General-purpose I/O port
	INT07		External interrupt input pin
20	P12	H	General-purpose I/O port
	EC0		8/16-bit composite timer ch. 0 clock input pin
	DBG		DBG input pin

*: For the I/O circuit types, see "11. I/O Circuit Type".

8. Pin Description (MB95270H Series, 8 pins)

Pin no.	Pin name	I/O circuit type*	Function
1	V _{SS}	—	Power supply pin (GND)
2	V _{CC}	—	Power supply pin
3	C	—	Capacitor connection pin
4	PF2	A	General-purpose I/O port
	$\overline{\text{RST}}$		Reset pin This pin is a dedicated reset pin in MB95F272H/F273H/F274H.
5	P04	F	General-purpose I/O port
	INT04		External interrupt input pin
	AN04		A/D converter analog input pin
	EC0		8/16-bit composite timer ch. 0 clock input pin
6	P05	E	General-purpose I/O port High-current pin
	AN05		A/D converter analog input pin
	TO00		8/16-bit composite timer ch. 0 output pin
7	P06	G	General-purpose I/O port High-current pin
	INT06		External interrupt input pin
	TO01		8/16-bit composite timer ch. 0 output pin
8	P12	H	General-purpose I/O port
	EC0		8/16-bit composite timer ch. 0 clock input pin
	DBG		DBG input pin

*: For the I/O circuit types, see “11. I/O Circuit Type”.

9. Pin Description (MB95280H Series, 32 pins)

Pin no.	Pin name	I/O circuit type*	Function
1	PF1	B	General-purpose I/O port
	X1		Main clock I/O oscillation pin
2	PF0	B	General-purpose I/O port
	X0		Main clock input oscillation pin
3	Vss	—	Power supply pin (GND)
4	PG2	C	General-purpose I/O port
	X1A		Subclock I/O oscillation pin
5	PG1	C	General-purpose I/O port
	X0A		Subclock input oscillation pin
6	Vcc	—	Power supply pin
7	C	—	Capacitor connection pin
8	PF2	A	General-purpose I/O port
	$\overline{\text{RST}}$		Reset pin This is a dedicated reset pin in MB95F282H/F283H/F284H.
9	NC	—	It is an internally connected pin. Always leave it unconnected.
10	NC	—	It is an internally connected pin. Always leave it unconnected.
11	NC	—	It is an internally connected pin. Always leave it unconnected.
12	NC	—	It is an internally connected pin. Always leave it unconnected.
13	NC	—	It is an internally connected pin. Always leave it unconnected.
14	NC	—	It is an internally connected pin. Always leave it unconnected.
15	NC	—	It is an internally connected pin. Always leave it unconnected.
16	NC	—	It is an internally connected pin. Always leave it unconnected.
17	P01	E	General-purpose I/O port
	AN01		A/D converter analog input pin
18	P02	E	General-purpose I/O port
	INT02		External interrupt input pin
	AN02		A/D converter analog input pin
	SCK		LIN-UART clock I/O pin
19	P03	E	General-purpose I/O port
	INT03		External interrupt input pin
	AN03		A/D converter analog input pin
	SOT		LIN-UART data output pin
20	P04	F	General-purpose I/O port
	INT04		External interrupt input pin
	AN04		A/D converter analog input pin
	SIN		LIN-UART data input pin
	EC0		8/16-bit composite timer ch. 0 clock input pin

(Continued)

(Continued)

Pin no.	Pin name	I/O circuit type*	Function
21	P05	E	General-purpose I/O port High-current pin
	INT05		External interrupt input pin
	AN05		A/D converter analog input pin
	TO00		8/16-bit composite timer ch. 0 output pin
22	P06	G	General-purpose I/O port High-current pin
	INT06		External interrupt input pin
	TO01		8/16-bit composite timer ch. 0 output pin
23	P12	H	General-purpose I/O port
	EC0		8/16-bit composite timer ch. 0 clock input pin
	DBG		DBG input pin
24	P07	G	General-purpose I/O port
	INT07		External interrupt input pin
25	NC	—	It is an internally connected pin. Always leave it unconnected.
26	NC	—	It is an internally connected pin. Always leave it unconnected.
27	NC	—	It is an internally connected pin. Always leave it unconnected.
28	NC	—	It is an internally connected pin. Always leave it unconnected.
29	NC	—	It is an internally connected pin. Always leave it unconnected.
30	NC	—	It is an internally connected pin. Always leave it unconnected.
31	NC	—	It is an internally connected pin. Always leave it unconnected.
32	NC	—	It is an internally connected pin. Always leave it unconnected.

*: For the I/O circuit types, see "11. I/O Circuit Type".

10. Pin Description (MB95280H Series, 16 pins)

Pin no.	Pin name	I/O circuit type*	Function
1	PF0	B	General-purpose I/O port
	X0		Main clock input oscillation pin
2	PF1	B	General-purpose I/O port
	X1		Main clock I/O oscillation pin
3	V _{SS}	—	Power supply pin (GND)
4	PG2	C	General-purpose I/O port
	X1A		Subclock I/O oscillation pin
5	PG1	C	General-purpose I/O port
	X0A		Subclock input oscillation pin
6	V _{CC}	—	Power supply pin
7	PF2	A	General-purpose I/O port
	$\overline{\text{RST}}$		Reset pin This pin is a dedicated reset pin in MB95F282H/F283H/F284H.
8	C	—	Capacitor connection pin
9	P02	E	General-purpose I/O port
	INT02		External interrupt input pin
	AN02		A/D converter analog input pin
	SCK		LIN-UART clock I/O pin
10	P01	E	General-purpose I/O port
	AN01		A/D converter analog input pin
11	P03	E	General-purpose I/O port
	INT03		External interrupt input pin
	AN03		A/D converter analog input pin
	SOT		LIN-UART data output pin
12	P04	F	General-purpose I/O port
	INT04		External interrupt input pin
	AN04		A/D converter analog input pin
	SIN		LIN-UART data input pin
	EC0		8/16-bit composite timer ch. 0 clock input pin

(Continued)

(Continued)

Pin no.	Pin name	I/O circuit type*	Function
13	P05	E	General-purpose I/O port High-current pin
	INT05		External interrupt input pin
	AN05		A/D converter analog input pin
	TO00		8/16-bit composite timer ch. 0 clock input pin
14	P06	G	General-purpose I/O port High-current pin
	INT06		External interrupt input pin
	TO01		8/16-bit composite timer ch. 0 clock input pin
15	P07	G	General-purpose I/O port
	INT07		External interrupt input pin
16	P12	H	General-purpose I/O port
	EC0		8/16-bit composite timer ch. 0 clock input pin
	DBG		DBG input pin

*: For the I/O circuit types, see "11. I/O Circuit Type".

11. I/O Circuit Type

Type	Circuit	Remarks
A		<ul style="list-style-type: none"> • N-ch open drain output • Hysteresis input • Reset output
B		<ul style="list-style-type: none"> • Oscillation circuit • High-speed side • Feedback resistance: approx. 1 MΩ • CMOS output • Hysteresis input
C		<ul style="list-style-type: none"> • Oscillation circuit • Low-speed side • Feedback resistance: approx. 10 MΩ • CMOS output • Hysteresis input • Pull-up control available

(Continued)

(Continued)

Type	Circuit	Remarks
D		<ul style="list-style-type: none"> • CMOS output • Hysteresis input
E		<ul style="list-style-type: none"> • CMOS output • Hysteresis input • Pull-up control available
F		<ul style="list-style-type: none"> • CMOS output • Hysteresis input • CMOS input • Pull-up control available
G		<ul style="list-style-type: none"> • Hysteresis input • CMOS output • Pull-up control available
H		<ul style="list-style-type: none"> • N-ch open drain output • Hysteresis input

12. Notes on Device Handling

Preventing latch-ups

When using the device, ensure that the voltage applied does not exceed the maximum voltage rating.

In a CMOS IC, if a voltage higher than V_{CC} or a voltage lower than V_{SS} is applied to an input/output pin that is neither a medium-withstand voltage pin nor a high-withstand voltage pin, or if a voltage out of the rating range of power supply voltage mentioned in “24.1 Absolute Maximum Ratings” of “24. Electrical Characteristics” is applied to the V_{CC} pin or the V_{SS} pin, a latch-up may occur.

When a latch-up occurs, power supply current increases significantly, which may cause a component to be thermally destroyed.

Stabilizing supply voltage

Supply voltage must be stabilized.

A malfunction may occur when power supply voltage fluctuates rapidly even though the fluctuation is within the guaranteed operating range of the V_{CC} power supply voltage.

As a rule of voltage stabilization, suppress voltage fluctuation so that the fluctuation in V_{CC} ripple (p-p value) at the commercial frequency (50 Hz/60 Hz) does not exceed 10% of the standard V_{CC} value, and the transient fluctuation rate does not exceed 0.1 V/ms at a momentary fluctuation such as switching the power supply.

Notes on using the external clock

When an external clock is used, oscillation stabilization wait time is required for power-on reset, wake-up from subclock mode or stop mode.

13. Pin Connection

Treatment of unused pins

If an unused input pin is left unconnected, a component may be permanently damaged due to malfunctions or latch-ups. Always pull up or pull down an unused input pin through a resistor of at least 2 k Ω . Set an unused input/output pin to the output state and leave it unconnected, or set it to the input state and treat it the same as an unused input pin. If there is an unused output pin, leave it unconnected.

Power supply pins

To reduce unnecessary electro-magnetic emission, prevent malfunctions of strobe signals due to an increase in the ground level, and conform to the total output current standard, always connect the V_{CC} pin and the V_{SS} pin to the power supply and ground outside the device. In addition, connect the current supply source to the V_{CC} pin and the V_{SS} pin with low impedance.

It is also advisable to connect a ceramic capacitor of approximately 0.1 μ F as a bypass capacitor between the V_{CC} pin and the V_{SS} pin at a location close to this device.

DBG pin

Connect the DBG pin directly to an external pull-up resistor.

To prevent the device from unintentionally entering the debug mode due to noise, minimize the distance between the DBG pin and the V_{CC} or V_{SS} pin when designing the layout of the printed circuit board.

The DBG pin should not stay at “L” level after power-on until the reset output is released.

$\overline{\text{RST}}$ pin

Connect the $\overline{\text{RST}}$ pin directly to an external pull-up resistor.

To prevent the device from unintentionally entering the reset mode due to noise, minimize the distance between the $\overline{\text{RST}}$ pin and the V_{CC} or V_{SS} pin when designing the layout of the printed circuit board.

The PF2/ $\overline{\text{RST}}$ pin functions as the reset input/output pin after power-on. In addition, the reset output of the PF2/ $\overline{\text{RST}}$ pin can be enabled by the RSTOE bit of the SYSC register, and the reset input function and the general purpose I/O function can be selected by the RSTEN bit of the SYSC register.

C pin

Use a ceramic capacitor or a capacitor with equivalent frequency characteristics. The bypass capacitor for the V_{CC} pin must have a capacitance larger than C_S . For the connection to a smoothing capacitor C_S , see the diagram below. To prevent the device from unintentionally entering a mode to which the device is not set to transit due to noise, minimize the distance between the C pin and C_S and the distance between C_S and the V_{SS} pin when designing the layout of a printed circuit board.

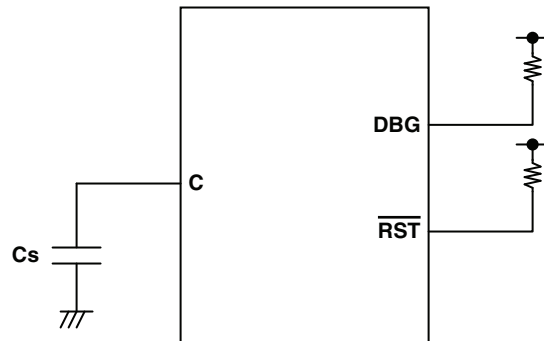
DBG/ \overline{RST} /C pins connection diagram

14. Block Diagram (MB95260H Series)

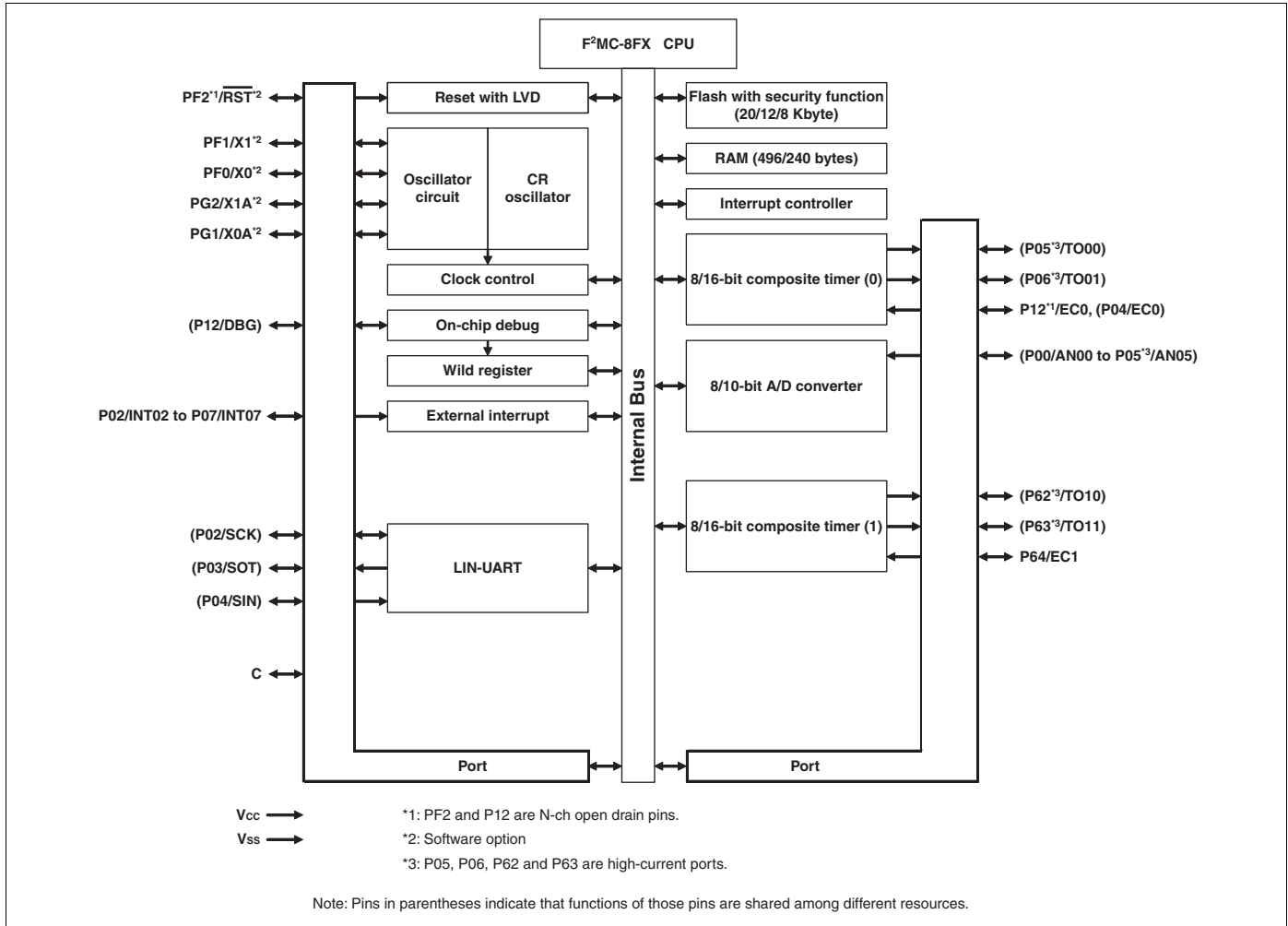

15. Block Diagram (MB95270H Series)

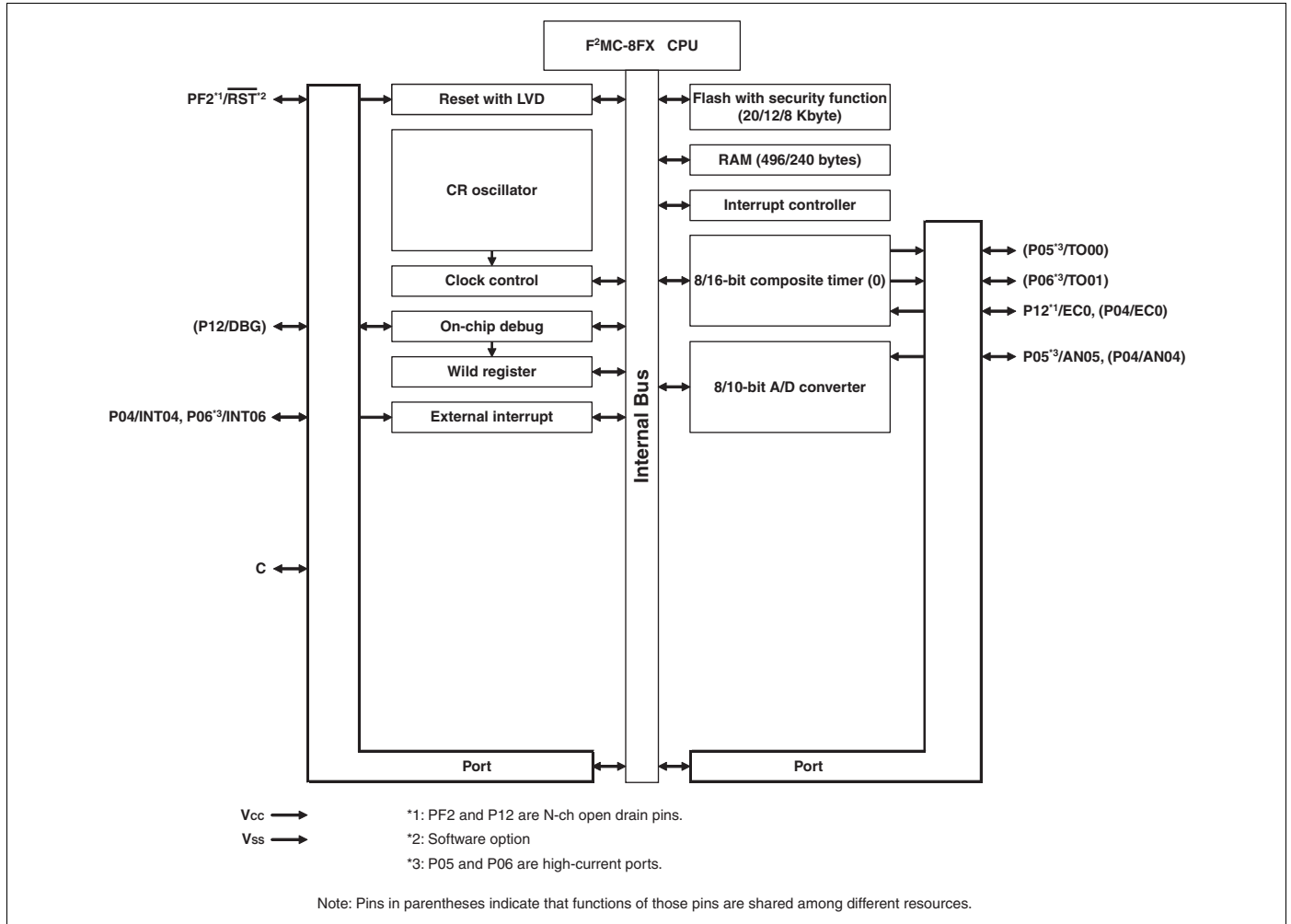

16. Block Diagram (MB95280H Series)

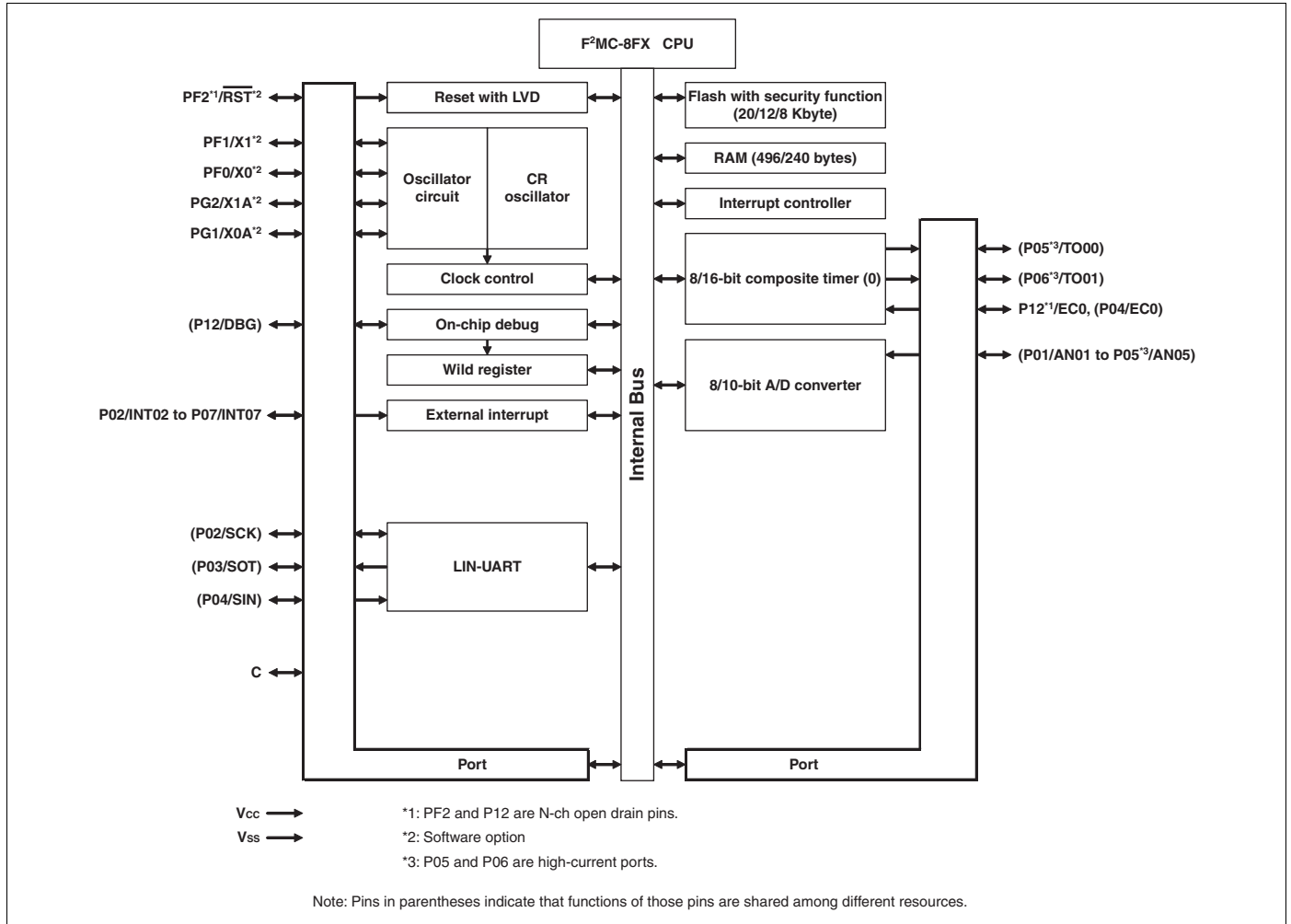

17. CPU Core

Memory Space

The memory space of the MB95260H/270H/280H Series is 64 Kbyte in size, and consists of an I/O area, a data area, and a program area. The memory space includes areas intended for specific purposes such as general-purpose registers and a vector table. The memory maps of the MB95260H/270H/280H Series are shown below.

Memory Maps

MB95F262H/F262K/F272H/ F272K/F282H/F282K	MB95F263H/F263K/F273H/ F273K/F283H/F283K	MB95F264H/F264K/F274H/ F274K/F284H/F284K
0000 _H	0000 _H	0000 _H
0080 _H	0080 _H	0080 _H
0090 _H	0090 _H	0090 _H
0100 _H	0100 _H	0100 _H
0180 _H	0200 _H	0200 _H
0F80 _H	0280 _H	0280 _H
1000 _H	0F80 _H	0F80 _H
B000 _H	1000 _H	1000 _H
C000 _H	B000 _H	B000 _H
F000 _H	C000 _H	Flash 20 Kbyte
FFFF _H	E000 _H	
	FFFF _H	

18. I/O Map (MB95260H Series)

Address	Register abbreviation	Register name	R/W	Initial value
0000 _H	PDR0	Port 0 data register	R/W	00000000 _B
0001 _H	DDR0	Port 0 direction register	R/W	00000000 _B
0002 _H	PDR1	Port 1 data register	R/W	00000000 _B
0003 _H	DDR1	Port 1 direction register	R/W	00000000 _B
0004 _H	—	(Disabled)	—	—
0005 _H	WATR	Oscillation stabilization wait time setting register	R/W	11111111 _B
0006 _H	—	(Disabled)	—	—
0007 _H	SYCC	System clock control register	R/W	0000X011 _B
0008 _H	STBC	Standby control register	R/W	00000XXX _B
0009 _H	RSRR	Reset source register	R/W	000XXXXX _B
000A _H	TBTC	Time-base timer control register	R/W	00000000 _B
000B _H	WPCR	Watch prescaler control register	R/W	00000000 _B
000C _H	WDTC	Watchdog timer control register	R/W	00XX0000 _B
000D _H	SYCC2	System clock control register 2	R/W	XX100011 _B
000E _H to 0015 _H	—	(Disabled)	—	—
0016 _H	PDR6	Port 6 data register	R/W	00000000 _B
0017 _H	DDR6	Port 6 direction register	R/W	00000000 _B
0018 _H to 0027 _H	—	(Disabled)	—	—
0028 _H	PDRF	Port F data register	R/W	00000000 _B
0029 _H	DDRF	Port F direction register	R/W	00000000 _B
002A _H	PDRG	Port G data register	R/W	00000000 _B
002B _H	DDRG	Port G direction register	R/W	00000000 _B
002C _H	PUL0	Port 0 pull-up register	R/W	00000000 _B
002D _H to 0034 _H	—	(Disabled)	—	—
0035 _H	PULG	Port G pull-up register	R/W	00000000 _B
0036 _H	T01CR1	8/16-bit composite timer 01 status control register 1 ch. 0	R/W	00000000 _B
0037 _H	T00CR1	8/16-bit composite timer 00 status control register 1 ch. 0	R/W	00000000 _B
0038 _H	T11CR1	8/16-bit composite timer 11 status control register 1 ch. 1	R/W	00000000 _B
0039 _H	T10CR1	8/16-bit composite timer 10 status control register 1 ch. 1	R/W	00000000 _B
003A _H to 0048 _H	—	(Disabled)	—	—
0049 _H	EIC10	External interrupt circuit control register ch. 2/ch. 3	R/W	00000000 _B

(Continued)

Address	Register abbreviation	Register name	R/W	Initial value
004A _H	EIC20	External interrupt circuit control register ch. 4/ch. 5	R/W	00000000 _B
004B _H	EIC30	External interrupt circuit control register ch. 6/ch. 7	R/W	00000000 _B
004C _H to 004F _H	—	(Disabled)	—	—
0050 _H	SCR	LIN-UART serial control register	R/W	00000000 _B
0051 _H	SMR	LIN-UART serial mode register	R/W	00000000 _B
0052 _H	SSR	LIN-UART serial status register	R/W	00001000 _B
0053 _H	RDR/TDR	LIN-UART receive/transmit data register	R/W	00000000 _B
0054 _H	ESCR	LIN-UART extended status control register	R/W	00000100 _B
0055 _H	ECCR	LIN-UART extended communication control register	R/W	000000XX _B
0056 _H to 006B _H	—	(Disabled)	—	—
006C _H	ADC1	8/10-bit A/D converter control register 1	R/W	00000000 _B
006D _H	ADC2	8/10-bit A/D converter control register 2	R/W	00000000 _B
006E _H	ADDH	8/10-bit A/D converter data register upper	R/W	00000000 _B
006F _H	ADDL	8/10-bit A/D converter data register lower	R/W	00000000 _B
0070 _H	—	(Disabled)	—	—
0071 _H	FSR2	Flash memory status register 2	R/W	00000000 _B
0072 _H	FSR	Flash memory status register	R/W	000X0000 _B
0073 _H	SWRE0	Flash memory sector write control register 0	R/W	00000000 _B
0074 _H	FSR3	Flash memory status register 3	R	0000XXXX _B
0075 _H	—	(Disabled)	—	—
0076 _H	WREN	Wild register address compare enable register	R/W	00000000 _B
0077 _H	WROR	Wild register data test setting register	R/W	00000000 _B
0078 _H	—	Mirror of register bank pointer (RP) and direct bank pointer (DP)	—	—
0079 _H	ILR0	Interrupt level setting register 0	R/W	11111111 _B
007A _H	ILR1	Interrupt level setting register 1	R/W	11111111 _B
007B _H	ILR2	Interrupt level setting register 2	R/W	11111111 _B
007C _H	ILR3	Interrupt level setting register 3	R/W	11111111 _B
007D _H	ILR4	Interrupt level setting register 4	R/W	11111111 _B
007E _H	ILR5	Interrupt level setting register 5	R/W	11111111 _B
007F _H	—	(Disabled)	—	—
0F80 _H	WRARH0	Wild register address setting register (Upper) ch. 0	R/W	00000000 _B

(Continued)

Address	Register abbreviation	Register name	R/W	Initial value
0F81 _H	WRARL0	Wild register address setting register (Lower) ch. 0	R/W	00000000 _B
0F82 _H	WRDR0	Wild register data setting register ch. 0	R/W	00000000 _B
0F83 _H	WRARH1	Wild register address setting register (Upper) ch. 1	R/W	00000000 _B
0F84 _H	WRARL1	Wild register address setting register (Lower) ch. 1	R/W	00000000 _B
0F85 _H	WRDR1	Wild register data setting register ch. 1	R/W	00000000 _B
0F86 _H	WRARH2	Wild register address setting register (Upper) ch. 2	R/W	00000000 _B
0F87 _H	WRARL2	Wild register address setting register (Lower) ch. 2	R/W	00000000 _B
0F88 _H	WRDR2	Wild register data setting register ch. 2	R/W	00000000 _B
0F89 _H to 0F91 _H	—	(Disabled)	—	—
0F92 _H	T01CR0	8/16-bit composite timer 01 status control register 0 ch. 0	R/W	00000000 _B
0F93 _H	T00CR0	8/16-bit composite timer 00 status control register 0 ch. 0	R/W	00000000 _B
0F94 _H	T01DR	8/16-bit composite timer 01 data register ch. 0	R/W	00000000 _B
0F95 _H	T00DR	8/16-bit composite timer 00 data register ch. 0	R/W	00000000 _B
0F96 _H	TMCR0	8/16-bit composite timer 00/01 timer mode control register ch. 0	R/W	00000000 _B
0F97 _H	T11CR0	8/16-bit composite timer 11 status control register 0 ch. 1	R/W	00000000 _B
0F98 _H	T10CR0	8/16-bit composite timer 10 status control register 0 ch. 1	R/W	00000000 _B
0F99 _H	T11DR	8/16-bit composite timer 11 data register ch. 1	R/W	00000000 _B
0F9A _H	T10DR	8/16-bit composite timer 10 data register ch. 1	R/W	00000000 _B
0F9B _H	TMCR1	8/16-bit composite timer 10/11 timer mode control register ch. 1	R/W	00000000 _B
0F9C _H to 0FBB _H	—	(Disabled)	—	—
0FBC _H	BGR1	LIN-UART baud rate generator register 1	R/W	00000000 _B
0FBD _H	BGR0	LIN-UART baud rate generator register 0	R/W	00000000 _B
0FBE _H to 0FC2 _H	—	(Disabled)	—	—
0FC3 _H	AIDRL	A/D input disable register (Lower)	R/W	00000000 _B
0FC4 _H to 0FE3 _H	—	(Disabled)	—	—
0FE4 _H	CRTH	Main CR clock trimming register (Upper)	R/W	1XXXXXXX _B
0FE5 _H	CRTL	Main CR clock trimming register (Lower)	R/W	000XXXXX _B

(Continued)

(Continued)

Address	Register abbreviation	Register name	R/W	Initial value
0FE6 _H , 0FE7 _H	—	(Disabled)	—	—
0FE8 _H	SYSC	System configuration register	R/W	11000011 _B
0FE9 _H	CMCR	Clock monitoring control register	R/W	00000000 _B
0FEA _H	CMDR	Clock monitoring data register	R/W	00000000 _B
0FEB _H	WDTH	Watchdog timer selection ID register (Upper)	R/W	XXXXXXXX _B
0FEC _H	WDTL	Watchdog timer selection ID register (Lower)	R/W	XXXXXXXX _B
0FED _H	—	(Disabled)	—	—
0FEE _H	ILSR	Input level select register	R/W	00000000 _B
0FEF _H to 0FFF _H	—	(Disabled)	—	—

R/W access symbols

R/W : Readable / Writable

R : Read only

Initial value symbols

0 : The initial value of this bit is "0".

1 : The initial value of this bit is "1".

X : The initial value of this bit is undefined.

Note: Do not write to an address that is "(Disabled)". If a "(Disabled)" address is read, an indeterminate value is returned.

19. I/O Map (MB95270H Series)

Address	Register abbreviation	Register name	R/W	Initial value
0000 _H	PDR0	Port 0 data register	R/W	00000000 _B
0001 _H	DDR0	Port 0 direction register	R/W	00000000 _B
0002 _H	PDR1	Port 1 data register	R/W	00000000 _B
0003 _H	DDR1	Port 1 direction register	R/W	00000000 _B
0004 _H	—	(Disabled)	—	—
0005 _H	WATR	Oscillation stabilization wait time setting register	R/W	11111111 _B
0006 _H	—	(Disabled)	—	—
0007 _H	SYCC	System clock control register	R/W	0000X011 _B
0008 _H	STBC	Standby control register	R/W	0000XXXX _B
0009 _H	RSRR	Reset source register	R/W	000XXXXX _B
000A _H	TBTC	Time-base timer control register	R/W	00000000 _B
000B _H	WPCR	Watch prescaler control register	R/W	00000000 _B
000C _H	WDTC	Watchdog timer control register	R/W	00XX0000 _B
000D _H	SYCC2	System clock control register 2	R/W	XX100011 _B
000E _H to 0015 _H	—	(Disabled)	—	—
0016 _H	—	(Disabled)	—	—
0017 _H	—	(Disabled)	—	—
0018 _H to 0027 _H	—	(Disabled)	—	—
0028 _H	PDRF	Port F data register	R/W	00000000 _B
0029 _H	DDRF	Port F direction register	R/W	00000000 _B
002A _H	—	(Disabled)	—	—
002B _H	—	(Disabled)	—	—
002C _H	PUL0	Port 0 pull-up register	R/W	00000000 _B
002D _H to 0034 _H	—	(Disabled)	—	—
0035 _H	—	(Disabled)	—	—
0036 _H	T01CR1	8/16-bit composite timer 01 status control register 1 ch. 0	R/W	00000000 _B
0037 _H	T00CR1	8/16-bit composite timer 00 status control register 1 ch. 0	R/W	00000000 _B
0038 _H	—	(Disabled)	—	—
0039 _H	—	(Disabled)	—	—
003A _H to 0048 _H	—	(Disabled)	—	—
0049 _H	—	(Disabled)	—	—

(Continued)

Address	Register abbreviation	Register name	R/W	Initial value
004A _H	EIC20	External interrupt circuit control register ch. 4	R/W	00000000 _B
004B _H	EIC30	External interrupt circuit control register ch. 6	R/W	00000000 _B
004C _H to 004F _H	—	(Disabled)	—	—
0050 _H	—	(Disabled)	—	—
0051 _H	—	(Disabled)	—	—
0052 _H	—	(Disabled)	—	—
0053 _H	—	(Disabled)	—	—
0054 _H	—	(Disabled)	—	—
0055 _H	—	(Disabled)	—	—
0056 _H to 006B _H	—	(Disabled)	—	—
006C _H	ADC1	8/10-bit A/D converter control register 1	R/W	00000000 _B
006D _H	ADC2	8/10-bit A/D converter control register 2	R/W	00000000 _B
006E _H	ADDH	8/10-bit A/D converter data register upper	R/W	00000000 _B
006F _H	ADDL	8/10-bit A/D converter data register lower	R/W	00000000 _B
0070 _H	—	(Disabled)	—	—
0071 _H	FSR2	Flash memory status register 2	R/W	00000000 _B
0072 _H	FSR	Flash memory status register	R/W	00X0000 _B
0073 _H	SWRE0	Flash memory sector write control register 0	R/W	00000000 _B
0074 _H	FSR3	Flash memory status register 3	R	0000XXXX _B
0075 _H	—	(Disabled)	—	—
0076 _H	WREN	Wild register address compare enable register	R/W	00000000 _B
0077 _H	WROR	Wild register data test setting register	R/W	00000000 _B
0078 _H	—	Mirror of register bank pointer (RP) and direct bank pointer (DP)	—	—
0079 _H	ILR0	Interrupt level setting register 0	R/W	11111111 _B
007A _H	ILR1	Interrupt level setting register 1	R/W	11111111 _B
007B _H	—	(Disabled)	—	—
007C _H	—	(Disabled)	—	—
007D _H	ILR4	Interrupt level setting register 4	R/W	11111111 _B
007E _H	ILR5	Interrupt level setting register 5	R/W	11111111 _B
007F _H	—	(Disabled)	—	—
0F80 _H	WRARH0	Wild register address setting register (Upper) ch. 0	R/W	00000000 _B
0F81 _H	WRARL0	Wild register address setting register (Lower) ch. 0	R/W	00000000 _B
0F82 _H	WRDR0	Wild register data setting register ch. 0	R/W	00000000 _B

(Continued)

Address	Register abbreviation	Register name	R/W	Initial value
0F83 _H	WRARH1	Wild register address setting register (Upper) ch. 1	R/W	00000000 _B
0F84 _H	WRARL1	Wild register address setting register (Lower) ch. 1	R/W	00000000 _B
0F85 _H	WRDR1	Wild register data setting register ch. 1	R/W	00000000 _B
0F86 _H	WRARH2	Wild register address setting register (Upper) ch. 2	R/W	00000000 _B
0F87 _H	WRARL2	Wild register address setting register (Lower) ch. 2	R/W	00000000 _B
0F88 _H	WRDR2	Wild register data setting register ch. 2	R/W	00000000 _B
0F89 _H to 0F91 _H	—	(Disabled)	—	—
0F92 _H	T01CR0	8/16-bit composite timer 01 status control register 0 ch. 0	R/W	00000000 _B
0F93 _H	T00CR0	8/16-bit composite timer 00 status control register 0 ch. 0	R/W	00000000 _B
0F94 _H	T01DR	8/16-bit composite timer 01 data register ch. 0	R/W	00000000 _B
0F95 _H	T00DR	8/16-bit composite timer 00 data register ch. 0	R/W	00000000 _B
0F96 _H	TMCR0	8/16-bit composite timer 00/01 timer mode control register ch. 0	R/W	00000000 _B
0F97 _H	—	(Disabled)	—	—
0F98 _H	—	(Disabled)	—	—
0F99 _H	—	(Disabled)	—	—
0F9A _H	—	(Disabled)	—	—
0F9B _H	—	(Disabled)	—	—
0F9C _H to 0FBB _H	—	(Disabled)	—	—
0FBC _H	—	(Disabled)	—	—
0FBD _H	—	(Disabled)	—	—
0FBE _H to 0FC2 _H	—	(Disabled)	—	—
0FC3 _H	AIDRL	A/D input disable register (Lower)	R/W	00000000 _B
0FC4 _H to 0FE3 _H	—	(Disabled)	—	—
0FE4 _H	CRTH	Main CR clock trimming register (Upper)	R/W	1XXXXXXX _B
0FE5 _H	CRTL	Main CR clock trimming register (Lower)	R/W	000XXXXX _B
0FE6 _H , 0FE7 _H	—	(Disabled)	—	—
0FE8 _H	SYSC	System configuration register	R/W	11000011 _B

(Continued)

(Continued)

Address	Register abbreviation	Register name	R/W	Initial value
0FE9 _H	CMCR	Clock monitoring control register	R/W	00000000 _B
0FEA _H	CMDR	Clock monitoring data register	R/W	00000000 _B
0FEB _H	WDTH	Watchdog timer selection ID register (Upper)	R/W	XXXXXXXX _B
0FEC _H	WDTL	Watchdog timer selection ID register (Lower)	R/W	XXXXXXXX _B
0FED _H	—	(Disabled)	—	—
0FEE _H	ILSR	Input level select register	R/W	00000000 _B
0FEF _H to 0FFF _H	—	(Disabled)	—	—

R/W access symbols

R/W : Readable / Writable

R : Read only

Initial value symbols

0 : The initial value of this bit is "0".

1 : The initial value of this bit is "1".

X : The initial value of this bit is undefined.

Note: Do not write to an address that is "(Disabled)". If a "(Disabled)" address is read, an indeterminate value is returned.

20. I/O Map (MB95280H Series)

Address	Register abbreviation	Register name	R/W	Initial value
0000 _H	PDR0	Port 0 data register	R/W	00000000 _B
0001 _H	DDR0	Port 0 direction register	R/W	00000000 _B
0002 _H	PDR1	Port 1 data register	R/W	00000000 _B
0003 _H	DDR1	Port 1 direction register	R/W	00000000 _B
0004 _H	—	(Disabled)	—	—
0005 _H	WATR	Oscillation stabilization wait time setting register	R/W	11111111 _B
0006 _H	—	(Disabled)	—	—
0007 _H	SYCC	System clock control register	R/W	0000X011 _B
0008 _H	STBC	Standby control register	R/W	0000XXX _B
0009 _H	RSRR	Reset source register	R/W	000XXXX _B
000A _H	TBTC	Time-base timer control register	R/W	00000000 _B
000B _H	WPCR	Watch prescaler control register	R/W	00000000 _B
000C _H	WDTC	Watchdog timer control register	R/W	00XX0000 _B
000D _H	SYCC2	System clock control register 2	R/W	XX100011 _B
000E _H to 0015 _H	—	(Disabled)	—	—
0016 _H	—	(Disabled)	—	—
0017 _H	—	(Disabled)	—	—
0018 _H to 0027 _H	—	(Disabled)	—	—
0028 _H	PDRF	Port F data register	R/W	00000000 _B
0029 _H	DDRF	Port F direction register	R/W	00000000 _B
002A _H	PDRG	Port G data register	R/W	00000000 _B
002B _H	DDRG	Port G direction register	R/W	00000000 _B
002C _H	PUL0	Port 0 pull-up register	R/W	00000000 _B
002D _H to 0034 _H	—	(Disabled)	—	—
0035 _H	PULG	Port G pull-up register	R/W	00000000 _B
0036 _H	T01CR1	8/16-bit composite timer 01 status control register 1 ch. 0	R/W	00000000 _B
0037 _H	T00CR1	8/16-bit composite timer 00 status control register 1 ch. 0	R/W	00000000 _B
0038 _H	—	(Disabled)	—	—
0039 _H	—	(Disabled)	—	—
003A _H to 0048 _H	—	(Disabled)	—	—
0049 _H	EIC10	External interrupt circuit control register ch. 2/ch. 3	R/W	00000000 _B

(Continued)

Address	Register abbreviation	Register name	R/W	Initial value
004A _H	EIC20	External interrupt circuit control register ch. 4/ch. 5	R/W	00000000 _B
004B _H	EIC30	External interrupt circuit control register ch. 6/ch. 7	R/W	00000000 _B
004C _H to 004F _H	—	(Disabled)	—	—
0050 _H	SCR	LIN-UART serial control register	R/W	00000000 _B
0051 _H	SMR	LIN-UART serial mode register	R/W	00000000 _B
0052 _H	SSR	LIN-UART serial status register	R/W	00001000 _B
0053 _H	RDR/TDR	LIN-UART receive/transmit data register	R/W	00000000 _B
0054 _H	ESCR	LIN-UART extended status control register	R/W	00000100 _B
0055 _H	ECCR	LIN-UART extended communication control register	R/W	000000XX _B
0056 _H to 006B _H	—	(Disabled)	—	—
006C _H	ADC1	8/10-bit A/D converter control register 1	R/W	00000000 _B
006D _H	ADC2	8/10-bit A/D converter control register 2	R/W	00000000 _B
006E _H	ADDH	8/10-bit A/D converter data register upper	R/W	00000000 _B
006F _H	ADDL	8/10-bit A/D converter data register lower	R/W	00000000 _B
0070 _H	—	(Disabled)	—	—
0071 _H	FSR2	Flash memory status register 2	R/W	00000000 _B
0072 _H	FSR	Flash memory status register	R/W	000X0000 _B
0073 _H	SWRE0	Flash memory sector write control register 0	R/W	00000000 _B
0074 _H	FSR3	Flash memory status register 3	R	0000XXXX _B
0075 _H	—	(Disabled)	—	—
0076 _H	WREN	Wild register address compare enable register	R/W	00000000 _B
0077 _H	WROR	Wild register data test setting register	R/W	00000000 _B
0078 _H	—	Mirror of register bank pointer (RP) and direct bank pointer (DP)	—	—
0079 _H	ILR0	Interrupt level setting register 0	R/W	11111111 _B
007A _H	ILR1	Interrupt level setting register 1	R/W	11111111 _B
007B _H	ILR2	Interrupt level setting register 2	R/W	11111111 _B
007C _H	ILR3	Interrupt level setting register 3	R/W	11111111 _B
007D _H	ILR4	Interrupt level setting register 4	R/W	11111111 _B
007E _H	ILR5	Interrupt level setting register 5	R/W	11111111 _B
007F _H	—	(Disabled)	—	—

(Continued)

Address	Register abbreviation	Register name	R/W	Initial value
0F80 _H	WRARH0	Wild register address setting register (Upper) ch. 0	R/W	00000000 _B
0F81 _H	WRARL0	Wild register address setting register (Lower) ch. 0	R/W	00000000 _B
0F82 _H	WRDR0	Wild register data setting register ch. 0	R/W	00000000 _B
0F83 _H	WRARH1	Wild register address setting register (Upper) ch. 1	R/W	00000000 _B
0F84 _H	WRARL1	Wild register address setting register (Lower) ch. 1	R/W	00000000 _B
0F85 _H	WRDR1	Wild register data setting register ch. 1	R/W	00000000 _B
0F86 _H	WRARH2	Wild register address setting register (Upper) ch. 2	R/W	00000000 _B
0F87 _H	WRARL2	Wild register address setting register (Lower) ch. 2	R/W	00000000 _B
0F88 _H	WRDR2	Wild register data setting register ch. 2	R/W	00000000 _B
0F89 _H to 0F91 _H	—	(Disabled)	—	—
0F92 _H	T01CR0	8/16-bit composite timer 01 status control register 0 ch. 0	R/W	00000000 _B
0F93 _H	T00CR0	8/16-bit composite timer 00 status control register 0 ch. 0	R/W	00000000 _B
0F94 _H	T01DR	8/16-bit composite timer 01 data register ch. 0	R/W	00000000 _B
0F95 _H	T00DR	8/16-bit composite timer 00 data register ch. 0	R/W	00000000 _B
0F96 _H	TMCR0	8/16-bit composite timer 00/01 timer mode control register ch. 0	R/W	00000000 _B
0F97 _H	—	(Disabled)	—	—
0F98 _H	—	(Disabled)	—	—
0F99 _H	—	(Disabled)	—	—
0F9A _H	—	(Disabled)	—	—
0F9B _H	—	(Disabled)	—	—
0F9C _H to 0FBB _H	—	(Disabled)	—	—
0FBC _H	BGR1	LIN-UART baud rate generator register 1	R/W	00000000 _B
0FBD _H	BGR0	LIN-UART baud rate generator register 0	R/W	00000000 _B
0FBE _H to 0FC2 _H	—	(Disabled)	—	—
0FC3 _H	AIDRL	A/D input disable register (Lower)	R/W	00000000 _B
0FC4 _H to 0FE3 _H	—	(Disabled)	—	—
0FE4 _H	CRTH	Main CR clock trimming register (Upper)	R/W	1XXXXXXX _B
0FE5 _H	CRTL	Main CR clock trimming register (Lower)	R/W	000XXXXX _B

(Continued)

(Continued)

Address	Register abbreviation	Register name	R/W	Initial value
0FE6 _H , 0FE7 _H	—	(Disabled)	—	—
0FE8 _H	SYSC	System configuration register	R/W	11000011 _B
0FE9 _H	CMCR	Clock monitoring control register	R/W	00000000 _B
0FEA _H	CMDR	Clock monitoring data register	R/W	00000000 _B
0FEB _H	WDTH	Watchdog timer selection ID register (Upper)	R/W	XXXXXXXX _B
0FEC _H	WDTL	Watchdog timer selection ID register (Lower)	R/W	XXXXXXXX _B
0FED _H	—	(Disabled)	—	—
0FEE _H	ILSR	Input level select register	R/W	00000000 _B
0FEF _H to 0FFF _H	—	(Disabled)	—	—

R/W access symbols

R/W : Readable / Writable

R : Read only

Initial value symbols



0 : The initial value of this bit is "0".

1 : The initial value of this bit is "1".



X : The initial value of this bit is undefined.

Note: Do not write to an address that is "(Disabled)". If a "(Disabled)" address is read, an indeterminate value is returned.

21. Interrupt Source Table (MB95260H Series)

Interrupt source	Interrupt request number	Vector table address		Bit name of interrupt level setting register	Priority order of interrupt sources of the same level (occurring simultaneously)
		Upper	Lower		
External interrupt ch. 4	IRQ00	FFFA _H	FFFB _H	L00 [1:0]	<div style="text-align: center;">High</div>   <div style="text-align: center;">Low</div>
External interrupt ch. 5	IRQ01	FFF8 _H	FFF9 _H	L01 [1:0]	
External interrupt ch. 2	IRQ02	FFF6 _H	FFF7 _H	L02 [1:0]	
External interrupt ch. 6					
External interrupt ch. 3	IRQ03	FFF4 _H	FFF5 _H	L03 [1:0]	
External interrupt ch. 7					
—	IRQ04	FFF2 _H	FFF3 _H	L04 [1:0]	
8/16-bit composite timer ch. 0 (Lower)	IRQ05	FFF0 _H	FFF1 _H	L05 [1:0]	
8/16-bit composite timer ch. 0 (Upper)	IRQ06	FFEE _H	FFEF _H	L06 [1:0]	
LIN-UART (reception)	IRQ07	FFEC _H	FFED _H	L07 [1:0]	
LIN-UART (transmission)	IRQ08	FFEA _H	FFEB _H	L08 [1:0]	
—	IRQ09	FFE8 _H	FFE9 _H	L09 [1:0]	
—	IRQ10	FFE6 _H	FFE7 _H	L10 [1:0]	
—	IRQ11	FFE4 _H	FFE5 _H	L11 [1:0]	
—	IRQ12	FFE2 _H	FFE3 _H	L12 [1:0]	
—	IRQ13	FFE0 _H	FFE1 _H	L13 [1:0]	
8/16-bit composite timer ch. 1 (Upper)	IRQ14	FFDE _H	FFDF _H	L14 [1:0]	
—	IRQ15	FFDC _H	FFDD _H	L15 [1:0]	
—	IRQ16	FFDA _H	FFDB _H	L16 [1:0]	
—	IRQ17	FFD8 _H	FFD9 _H	L17 [1:0]	
8/10-bit A/D converter	IRQ18	FFD6 _H	FFD7 _H	L18 [1:0]	
Time-base timer	IRQ19	FFD4 _H	FFD5 _H	L19 [1:0]	
Watch prescaler	IRQ20	FFD2 _H	FFD3 _H	L20 [1:0]	
—	IRQ21	FFD0 _H	FFD1 _H	L21 [1:0]	
8/16-bit composite timer ch. 1 (Lower)	IRQ22	FFCE _H	FFCF _H	L22 [1:0]	
Flash memory	IRQ23	FFCC _H	FFCD _H	L23 [1:0]	

22. Interrupt Source Table (MB95270H Series)

Interrupt source	Interrupt request number	Vector table address		Bit name of interrupt level setting register	Priority order of interrupt sources of the same level (occurring simultaneously)
		Upper	Lower		
External interrupt ch. 4	IRQ00	FFFA _H	FFFB _H	L00 [1:0]	<div style="text-align: center;"> High   Low </div>
—	IRQ01	FFF8 _H	FFF9 _H	L01 [1:0]	
—	IRQ02	FFF6 _H	FFF7 _H	L02 [1:0]	
External interrupt ch. 6		—	FFF4 _H	FFF5 _H	
—	IRQ03	FFF4 _H	FFF5 _H	L03 [1:0]	
—	IRQ04	FFF2 _H	FFF3 _H	L04 [1:0]	
8/16-bit composite timer ch. 0 (Lower)	IRQ05	FFF0 _H	FFF1 _H	L05 [1:0]	
8/16-bit composite timer ch. 0 (Upper)	IRQ06	FFEE _H	FFEF _H	L06 [1:0]	
—	IRQ07	FFEC _H	FFED _H	L07 [1:0]	
—	IRQ08	FFEA _H	FFEB _H	L08 [1:0]	
—	IRQ09	FFE8 _H	FFE9 _H	L09 [1:0]	
—	IRQ10	FFE6 _H	FFE7 _H	L10 [1:0]	
—	IRQ11	FFE4 _H	FFE5 _H	L11 [1:0]	
—	IRQ12	FFE2 _H	FFE3 _H	L12 [1:0]	
—	IRQ13	FFE0 _H	FFE1 _H	L13 [1:0]	
—	IRQ14	FFDE _H	FFDF _H	L14 [1:0]	
—	IRQ15	FFDC _H	FFDD _H	L15 [1:0]	
—	IRQ16	FFDA _H	FFDB _H	L16 [1:0]	
—	IRQ17	FFD8 _H	FFD9 _H	L17 [1:0]	
8/10-bit A/D converter	IRQ18	FFD6 _H	FFD7 _H	L18 [1:0]	
Time-base timer	IRQ19	FFD4 _H	FFD5 _H	L19 [1:0]	
Watch prescaler	IRQ20	FFD2 _H	FFD3 _H	L20 [1:0]	
—	IRQ21	FFD0 _H	FFD1 _H	L21 [1:0]	
—	IRQ22	FFCE _H	FFCF _H	L22 [1:0]	
Flash memory	IRQ23	FFCC _H	FFCD _H	L23 [1:0]	

23. Interrupt Source Table (MB95280H Series)

Interrupt source	Interrupt request number	Vector table address		Bit name of interrupt level setting register	Priority order of interrupt sources of the same level (occurring simultaneously)
		Upper	Lower		
External interrupt ch. 4	IRQ00	FFFA _H	FFFB _H	L00 [1:0]	<div style="text-align: center;"> High  Low </div>
External interrupt ch. 5	IRQ01	FFF8 _H	FFF9 _H	L01 [1:0]	
External interrupt ch. 2	IRQ02	FFF6 _H	FFF7 _H	L02 [1:0]	
External interrupt ch. 6					
External interrupt ch. 3	IRQ03	FFF4 _H	FFF5 _H	L03 [1:0]	
External interrupt ch. 7					
—	IRQ04	FFF2 _H	FFF3 _H	L04 [1:0]	
8/16-bit composite timer ch. 0 (Lower)	IRQ05	FFF0 _H	FFF1 _H	L05 [1:0]	
8/16-bit composite timer ch. 0 (Upper)	IRQ06	FFEE _H	FFEF _H	L06 [1:0]	
LIN-UART (reception)	IRQ07	FFEC _H	FFED _H	L07 [1:0]	
LIN-UART (transmission)	IRQ08	FFEA _H	FFEB _H	L08 [1:0]	
—	IRQ09	FFE8 _H	FFE9 _H	L09 [1:0]	
—	IRQ10	FFE6 _H	FFE7 _H	L10 [1:0]	
—	IRQ11	FFE4 _H	FFE5 _H	L11 [1:0]	
—	IRQ12	FFE2 _H	FFE3 _H	L12 [1:0]	
—	IRQ13	FFE0 _H	FFE1 _H	L13 [1:0]	
—	IRQ14	FFDE _H	FFDF _H	L14 [1:0]	
—	IRQ15	FFDC _H	FFDD _H	L15 [1:0]	
—	IRQ16	FFDA _H	FFDB _H	L16 [1:0]	
—	IRQ17	FFD8 _H	FFD9 _H	L17 [1:0]	
8/10-bit A/D converter	IRQ18	FFD6 _H	FFD7 _H	L18 [1:0]	
Time-base timer	IRQ19	FFD4 _H	FFD5 _H	L19 [1:0]	
Watch prescaler	IRQ20	FFD2 _H	FFD3 _H	L20 [1:0]	
—	IRQ21	FFD0 _H	FFD1 _H	L21 [1:0]	
—	IRQ22	FFCE _H	FFCF _H	L22 [1:0]	
Flash memory	IRQ23	FFCC _H	FFCD _H	L23 [1:0]	

24. Electrical Characteristics

24.1 Absolute Maximum Ratings

Parameter	Symbol	Rating		Unit	Remarks
		Min	Max		
Power supply voltage*1	V_{CC}	$V_{SS} - 0.3$	$V_{SS} + 6$	V	
Input voltage*1	V_I	$V_{SS} - 0.3$	$V_{SS} + 6$	V	*2
Output voltage*1	V_O	$V_{SS} - 0.3$	$V_{SS} + 6$	V	*2
Maximum clamp current	I_{CLAMP}	- 2	+ 2	mA	Applicable to specific pins*3
Total maximum clamp current	$\sum I_{CLAMP} $	—	20	mA	Applicable to specific pins*3
“L” level maximum output current	I_{OL1}	—	15	mA	Other than P05, P06, P62 and P63*4
	I_{OL2}		15		P05, P06, P62 and P63*4
“L” level average current	I_{OLAV1}	—	4	mA	Other than P05, P06, P62 and P63*4 Average output current= operating current × operating ratio (1 pin)
	I_{OLAV2}		12		P05, P06, P62 and P63*4 Average output current= operating current × operating ratio (1 pin)
“L” level total maximum output current	$\sum I_{OL}$	—	100	mA	
“L” level total average output current	$\sum I_{OLAV}$	—	50	mA	Total average output current= operating current × operating ratio (Total number of pins)
“H” level maximum output current	I_{OH1}	—	- 15	mA	Other than P05, P06, P62 and P63*4
	I_{OH2}		- 15		P05, P06, P62 and P63*4
“H” level average current	I_{OHAV1}	—	- 4	mA	Other than P05, P06, P62 and P63*4 Average output current= operating current × operating ratio (1 pin)
	I_{OHAV2}		- 8		P05, P06, P62 and P63*4 Average output current= operating current × operating ratio (1 pin)
“H” level total maximum output current	$\sum I_{OH}$	—	- 100	mA	
“H” level total average output current	$\sum I_{OHAV}$	—	- 50	mA	Total average output current= operating current × operating ratio (Total number of pins)
Power consumption	P_d	—	320	mW	
Operating temperature	T_A	- 40	+ 85	°C	
Storage temperature	T_{stg}	- 55	+ 150	°C	

(Continued)

(Continued)

*1: These parameters are based on the condition that V_{SS} is 0.0 V.

*2: V_I and V_O must not exceed $V_{CC} + 0.3$ V. V_I must not exceed the rated voltage. However, if the maximum current to/from an input is limited by means of an external component, the I_{CLAMP} rating is used instead of the V_I rating.

*3: Applicable to the following pins: P00 to P07, P62 to P64, PG1, PG2, PF0, PF1 (P00, P62, P63 and P64 are only available on MB95F262H/F262K/F263H/F263K/F264H/F264K. P01, P02, P03, P07, PG1, PG2, PF0 and PF1 are only available on MB95F262H/F262K/F263H/F263K/F264H/F264K/F282H/F282K/F283H/F283K/F284H/F284K.)

- Use under recommended operating conditions.
- Use with DC voltage (current).
- The HV (High Voltage) signal is an input signal exceeding the V_{CC} voltage. Always connect a limiting resistor between the HV (High Voltage) signal and the microcontroller before applying the HV (High Voltage) signal.
- The value of the limiting resistor should be set to a value at which the current to be input to the microcontroller pin when the HV (High Voltage) signal is input is below the standard value, irrespective of whether the current is transient current or stationary current.
- When the microcontroller drive current is low, such as in low power consumption modes, the HV (High Voltage) input potential may pass through the protective diode to increase the potential of the V_{CC} pin, affecting other devices.
- If the HV (High Voltage) signal is input when the microcontroller power supply is off (not fixed at 0 V), since power is supplied from the pins, incomplete operations may be executed.
- If the HV (High Voltage) input is input after power-on, since power is supplied from the pins, the voltage of power supply may not be sufficient to enable a power-on reset.
- Do not leave the HV (High Voltage) input pin unconnected.
- Example of a recommended circuit:

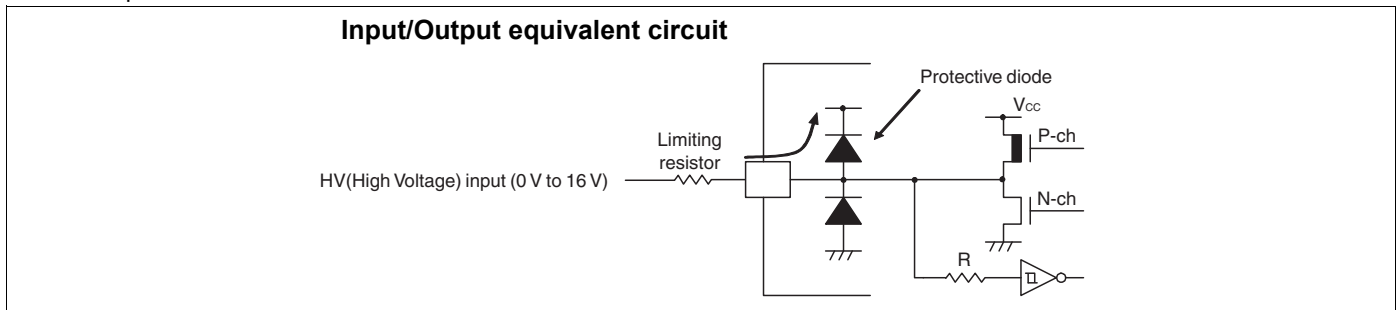

*4: P62 and P63 are only available on MB95F262H/F262K/F263H/F263K/F264H/F264K.

WARNING: Semiconductor devices can be permanently damaged by application of stress (voltage, current, temperature, etc.) in excess of absolute maximum ratings. Do not exceed these ratings.

24.2 Recommended Operating Conditions

 (V_{SS} = 0.0 V)

Parameter	Symbol	Value		Unit	Remarks	
		Min	Max			
Power supply voltage	V _{CC}	2.4*1*2	5.5*1	V	In normal operation	Other than on-chip debug mode
		2.3	5.5		Hold condition in stop mode	
		2.9	5.5		In normal operation	On-chip debug mode
		2.3	5.5		Hold condition in stop mode	
Smoothing capacitor	C _S	0.022	1	μF	*3	
Operating temperature	T _A	-40	+ 85	°C	Other than on-chip debug mode	
		+ 5	+ 35		On-chip debug mode	

*1: The value varies depending on the operating frequency, the machine clock and the analog guaranteed range.

*2: The value is 2.88 V when the low-voltage detection reset is used.

*3: Use a ceramic capacitor or a capacitor with equivalent frequency characteristics. The bypass capacitor for the V_{CC} pin must have a capacitance larger than C_S. For the connection to a smoothing capacitor C_S, see the diagram below. To prevent the device from unintentionally entering an unknown mode due to noise, minimize the distance between the C pin and C_S and the distance between C_S and the V_{SS} pin when designing the layout of a printed circuit board.

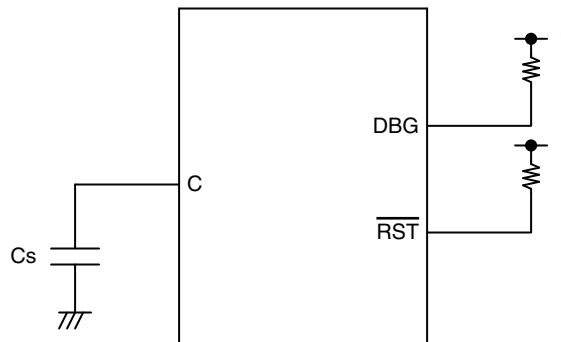
DBG / $\overline{\text{RST}}$ / C pins connection diagram

*: Since the DBG pin becomes a communication pin in on-chip debug mode, set a pull-up resistor value suiting the input/output specifications of P12/DBG.

WARNING: The recommended operating conditions are required in order to ensure the normal operation of the semiconductor device.

All of the device's electrical characteristics are warranted when the device is operated within these ranges.

Always use semiconductor devices within their recommended operating condition ranges.

Operation outside these ranges may adversely affect reliability and could result in device failure.

No warranty is made with respect to uses, operating conditions, or combinations not represented on the data sheet.

Users considering application outside the listed conditions are advised to contact their representatives beforehand.

24.3 DC Characteristics
 $(V_{CC} = 5.0 V \pm 10\%, V_{SS} = 0.0 V, T_A = -40^\circ C \text{ to } +85^\circ C)$

Parameter	Symbol	Pin name	Condition	Value			Unit	Remarks
				Min	Typ	Max		
"H" level input voltage	V_{IH1}	P04	*1	$0.7 V_{CC}$	—	$V_{CC} + 0.3$	V	When CMOS input level (hysteresis input) is selected
	V_{IHS}	P00 to P07, P12, P62 to P64, PF0, PF1, PG1, PG2	*1	$0.8 V_{CC}$	—	$V_{CC} + 0.3$	V	Hysteresis input
	V_{IHM}	PF2	—	$0.7 V_{CC}$	—	$V_{CC} + 0.3$	V	Hysteresis input
"L" level input voltage	V_{IL}	P04	*1	$V_{SS} - 0.3$	—	$0.3 V_{CC}$	V	When CMOS input level (hysteresis input) is selected
	V_{ILS}	P00 to P07, P12, P62 to P64, PF0, PF1, PG1, PG2	*1	$V_{SS} - 0.3$	—	$0.2 V_{CC}$	V	Hysteresis input
	V_{ILM}	PF2	—	$V_{SS} - 0.3$	—	$0.3 V_{CC}$	V	Hysteresis input
Open-drain output application voltage	V_D	PF2, P12	—	$V_{SS} - 0.3$	—	$V_{SS} + 5.5$	V	
"H" level output voltage	V_{OH1}	Output pins other than P05, P06, P12, P62, P63, PF2*2	$I_{OH} = -4 \text{ mA}$	$V_{CC} - 0.5$	—	—	V	
	V_{OH2}	P05, P06, P62, P63*2	$I_{OH} = -8 \text{ mA}$	$V_{CC} - 0.5$	—	—	V	
"L" level output voltage	V_{OL1}	Output pins other than P05, P06, P62, P63*2	$I_{OL} = 4 \text{ mA}$	—	—	0.4	V	
	V_{OL2}	P05, P06, P62, P63*2	$I_{OL} = 12 \text{ mA}$	—	—	0.4	V	
Input leak current (Hi-Z output leak current)	I_{LI}	All input pins	$0.0 V < V_I < V_{CC}$	- 5	—	+ 5	μA	When pull-up resistance is disabled
Pull-up resistance	R_{PULL}	P00 to P07, PG1, PG2*3*4	$V_I = 0 V$	25	50	100	k Ω	When pull-up resistance is enabled
Input capacitance	C_{IN}	Other than V_{CC} and V_{SS}	$f = 1 \text{ MHz}$	—	5	15	pF	

(Continued)

$(V_{CC} = 5.0\text{ V} \pm 10\%, V_{SS} = 0.0\text{ V}, T_A = -40^\circ\text{C to } +85^\circ\text{C})$

Parameter	Symbol	Pin name	Condition	Value			Unit	Remarks
				Min	Typ	Max		
Power supply current*4	I _{CC}	V _{CC} (External clock operation)	V _{CC} = 5.5 V F _{CH} = 32 MHz F _{MP} = 16 MHz Main clock mode (divided by 2)	—	13	17	mA	Except during Flash memory programming and erasing
			—	33.5	39.5	mA	During Flash memory programming and erasing	
			—	15	21	mA	At A/D conversion	
	I _{CCS}		V _{CC} = 5.5 V F _{CH} = 32 MHz F _{MP} = 16 MHz Main sleep mode (divided by 2)	—	5.5	9	mA	
	I _{CCCL}		V _{CC} = 5.5 V F _{CL} = 32 kHz F _{MPL} = 16 kHz Subclock mode (divided by 2) T _A = +25°C	—	65	153	μA	
	I _{CCLS}		V _{CC} = 5.5 V F _{CL} = 32 kHz F _{MPL} = 16 kHz Subsleep mode (divided by 2) T _A = +25°C	—	10	84	μA	
	I _{CCCT}		V _{CC} = 5.5 V F _{CL} = 32 kHz Watch mode Main stop mode T _A = +25°C	—	5	30	μA	
	I _{CCMCR}		V _{CC} = 5.5 V F _{CRH} = 10 MHz F _{MP} = 10 MHz Main CR clock mode	—	8.6	—	mA	
I _{CCSCR}	V _{CC} = 5.5 V Sub-CR clock mode (divided by 2) T _A = +25°C	—	110	410	μA			

(Continued)

(Continued)

($V_{CC} = 5.0\text{ V} \pm 10\%$, $V_{SS} = 0.0\text{ V}$, $T_A = -40^\circ\text{C}$ to $+85^\circ\text{C}$)

Parameter	Symbol	Pin name	Condition	Value			Unit	Remarks
				Min	Typ	Max		
Power supply current**4	I_{CCTS}	V_{CC} (External clock operation)	$V_{CC} = 5.5\text{ V}$ $F_{CH} = 32\text{ MHz}$ Time-base timer mode $T_A = +25^\circ\text{C}$	—	1.1	3	mA	
	I_{CCH}		$V_{CC} = 5.5\text{ V}$ Substop mode $T_A = +25^\circ\text{C}$	—	3.5	22.5	μA	Main stop mode for single external clock selection
	I_{LVD}	V_{CC}	Current consumption for low-voltage detection circuit only	—	37	54	μA	
	I_{CRH}		Current consumption for the main CR oscillator	—	0.5	0.6	mA	
	I_{CRL}		Current consumption for the sub-CR oscillator oscillating at 100 kHz	—	20	72	μA	

*1: The input level of P04 can be switched between “CMOS input level” and “hysteresis input level”. The input level selection register (ILSR) is used to switch between the two input levels.

*2: P62 and P63 are only available on MB95F262H/F262K/F263H/F263K/F264H/F264K.

*3: P00 is only available on MB95F262H/F262K/F263H/F263K/F264H/F264K. P01, P02, P03, P07, PG1 and PG2 are only available on MB95F262H/F262K/F263H/F263K/F264H/F264K/F282H/F282K/F283H/F283K/F284H/F284K.

- *4:
- The power supply current is determined by the external clock. When the low-voltage detection option is selected, the power-supply current will be the sum of adding the current consumption of the low-voltage detection circuit (I_{LVD}) to one of the value from I_{CC} to I_{CCH} . In addition, when both the low-voltage detection option and the CR oscillator are selected, the power supply current will be the sum of adding up the current consumption of the low-voltage detection circuit, the current consumption of the CR oscillators (I_{CRH} , I_{CRL}) and a specified value. In on-chip debug mode, the CR oscillator (I_{CRH}) and the low-voltage detection circuit are always enabled, and current consumption therefore increases accordingly.
 - See “24.4. AC Characteristics: 24.4.1. Clock Timing” for F_{CH} and F_{CL} .
 - See “24.4. AC Characteristics: 24.4.2. Source Clock / Machine Clock” for F_{MP} and F_{MPL} .

24.4 AC Characteristics
24.4.1 Clock Timing
 $(V_{CC} = 2.4 \text{ V to } 5.5 \text{ V}, V_{SS} = 0.0 \text{ V}, T_A = -40^\circ\text{C to } +85^\circ\text{C})$

Parameter	Symbol	Pin name	Condition	Value			Unit	Remarks	
				Min	Typ	Max			
Clock frequency	F _{CH}	X0, X1	—	1	—	16.25	MHz	When the main oscillation circuit is used	
		X0	X1 : open	1	—	12	MHz	When the main external clock is used	
		X0, X1	*1	1	—	32.5	MHz		
	F _{CRH}	—	—	—	9.7	10	10.3	MHz	When the main CR clock is used*2
					7.76	8	8.24	MHz	3.3 V ≤ V _{CC} ≤ 5.5 V (-40 °C ≤ T _A ≤ +40 °C)
					0.97	1	1.03	MHz	2.4 V ≤ V _{CC} < 3.3 V (0 °C ≤ T _A ≤ +40 °C)
					9.55	10	10.45	MHz	When the main CR clock is used*2 3.3 V ≤ V _{CC} ≤ 5.5 V (+40 °C < T _A ≤ +85 °C)
					7.64	8	8.36	MHz	
					0.955	1	1.045	MHz	
					9.5	10	10.5	MHz	When the main CR clock is used*2 2.4 V ≤ V _{CC} < 3.3 V (-40 °C ≤ T _A < 0 °C, +40 °C < T _A ≤ +85 °C)
					7.6	8	8.4	MHz	
					0.95	1	1.05	MHz	
					9.7	10	10.3	MHz	When the main CR clock is used*3 2.4 V ≤ V _{CC} ≤ 5.5 V (0 °C ≤ T _A ≤ +40 °C)
					7.76	8	8.24	MHz	
					0.97	1	1.03	MHz	
					9.5	10	10.5	MHz	When the main CR clock is used*3 2.4 V ≤ V _{CC} ≤ 5.5 V (-40 °C ≤ T _A < 0 °C, +40 °C < T _A ≤ +85 °C)
					7.6	8	8.4	MHz	
					0.95	1	1.05	MHz	
	F _{CL}	X0A, X1A	—	—	—	32.768	—	kHz	When the sub oscillation circuit is used
					—	32.768	—	kHz	When the sub-external clock is used
F _{CRL}	—	—	—	50	100	200	kHz	When the sub CR clock is used	
Clock cycle time	t _{H CYL}	X0, X1	—	61.5	—	1000	ns	When the main oscillation circuit is used	
		X0	X1 : open	83.4	—	1000	ns	When the external clock is used	
		X0, X1	*1	30.8	—	1000	ns		
	t _{L CYL}	X0A, X1A	—	—	30.5	—	μs	When the subclock is used	

(Continued)

(Continued)

($V_{CC} = 2.4\text{ V to }5.5\text{ V}$, $V_{SS} = 0.0\text{ V}$, $T_A = -40^\circ\text{C to }+85^\circ\text{C}$)

Parameter	Symbol	Pin name	Condition	Value			Unit	Remarks
				Min	Typ	Max		
Input clock pulse width	t_{WH1}	X0	X1 : open	33.4	—	—	ns	When the external clock is used, the duty ratio should range between 40% and 60%.
	t_{WL1}	X0, X1	*1	12.4	—	—	ns	
	t_{WH2} t_{WL2}	X0A	—	—	15.2	—	μs	
Input clock rise time and fall time	t_{CR}	X0	X1 : open	—	—	5	ns	When the external clock is used
	t_{CF}	X0, X1	*1	—	—	5	ns	
CR oscillation start time	t_{CRHWK}	—	—	—	—	80	μs	When the main CR clock is used
	t_{CRLWK}	—	—	—	—	10	μs	When the sub CR clock is used

*1: The external clock signal is input to X0 and the inverted external clock signal to X1.

*2: These specifications are not applicable to the following products: MB95F272HPH, MB95F272KPH, MB95F273HPH, MB95F273KPH, MB95F274HPH, MB95F274KPH, MB95F282HPH, MB95F282KPH, MB95F283HPH, MB95F283KPH, MB95F284HPH and MB95F284KPH.

*3: These specifications are only applicable to the following products: MB95F272HPH, MB95F272KPH, MB95F273HPH, MB95F273KPH, MB95F274HPH, MB95F274KPH, MB95F282HPH, MB95F282KPH, MB95F283HPH, MB95F283KPH, MB95F284HPH and MB95F284KPH.

Input waveform generated when an external clock (main clock) is used

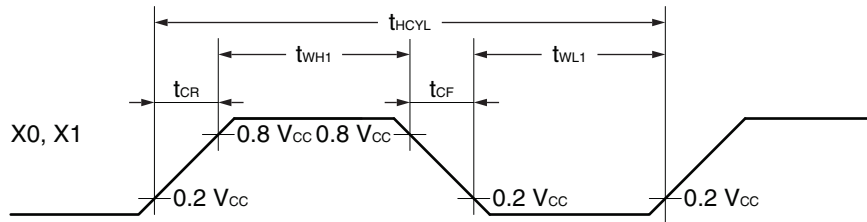
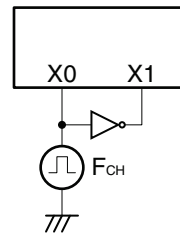
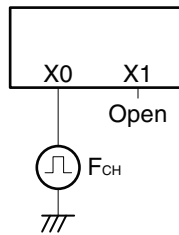
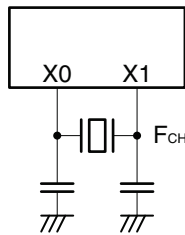

Figure of main clock input port external connection

When a crystal oscillator or a ceramic oscillator is used

When an external clock is used (X1 is open)

When an external clock is used



Input waveform generated when an external clock (subclock) is used

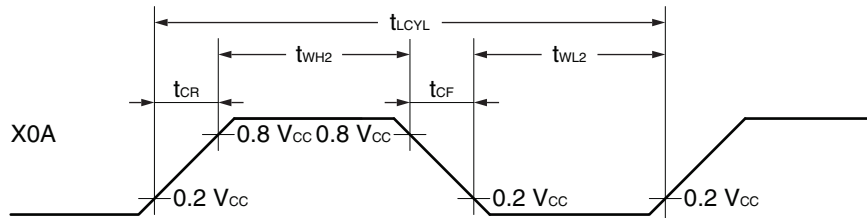
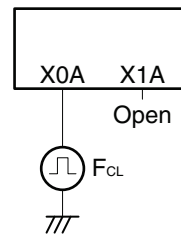
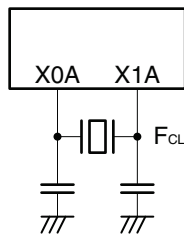

Figure of subclock input port external connection

When a crystal oscillator or a ceramic oscillator is used

When an external clock is used



24.4.2 Source Clock / Machine Clock
 $(V_{CC} = 5.0 V \pm 10\%, V_{SS} = 0.0 V, T_A = -40^\circ C \text{ to } +85^\circ C)$

Parameter	Symbol	Pin name	Value			Unit	Remarks
			Min	Typ	Max		
Source clock cycle time*1	t_{SCLK}	—	61.5	—	2000	ns	When the main external clock is used Min: $F_{CH} = 32.5$ MHz, divided by 2 Max: $F_{CH} = 1$ MHz, divided by 2
			100	—	1000	ns	When the main CR clock is used Min: $F_{CRH} = 10$ MHz Max: $F_{CRH} = 1$ MHz
			—	61	—	μs	When the sub-oscillation clock is used $F_{CL} = 32.768$ kHz, divided by 2
			—	20	—	μs	When the sub CR clock is used $F_{CRL} = 100$ kHz, divided by 2
Source clock frequency	F_{SP}	—	0.5	—	16.25	MHz	When the main oscillation clock is used
			1	—	10	MHz	When the main CR clock is used
	—		16.384	—	kHz	When the sub-oscillation clock is used	
	F_{SPL}		—	50	—	kHz	When the sub-CR clock is used $F_{CRL} = 100$ kHz, divided by 2
Machine clock cycle time*2 (minimum instruction execution time)	t_{MCLK}	—	61.5	—	32000	ns	When the main oscillation clock is used Min: $F_{SP} = 16.25$ MHz, no division Max: $F_{SP} = 0.5$ MHz, divided by 16
			100	—	16000	ns	When the main CR clock is used Min: $F_{SP} = 10$ MHz Max: $F_{SP} = 1$ MHz, divided by 16
			61	—	976.5	μs	When the sub-oscillation clock is used Min: $F_{SPL} = 16.384$ kHz, no division Max: $F_{SPL} = 16.384$ kHz, divided by 16
			20	—	320	μs	When the sub-CR clock is used Min: $F_{SPL} = 50$ kHz, no division Max: $F_{SPL} = 50$ kHz, divided by 16
Machine clock frequency	F_{MP}	—	0.031	—	16.25	MHz	When the main oscillation clock is used
			0.0625	—	10	MHz	When the main CR clock is used
	F_{MPL}		1.024	—	16.384	kHz	When the sub-oscillation clock is used
	F_{MPL}		3.125	—	50	kHz	When the sub-CR clock is used $F_{CRL} = 100$ kHz

*1: This is the clock before it is divided according to the division ratio set by the machine clock division ratio select bits (SYCC : DIV1 and DIV0) . This source clock is divided to become a machine clock according to the division ratio set by the machine clock division ratio select bits (SYCC : DIV1 and DIV0). In addition, a source clock can be selected from the following.

- Main clock divided by 2
- Main CR clock
- Subclock divided by 2
- Sub-CR clock divided by 2

*2: This is the operating clock of the microcontroller. A machine clock can be selected from the following.

- Source clock (no division)
- Source clock divided by 4
- Source clock divided by 8
- Source clock divided by 16

Schematic diagram of the clock generation block

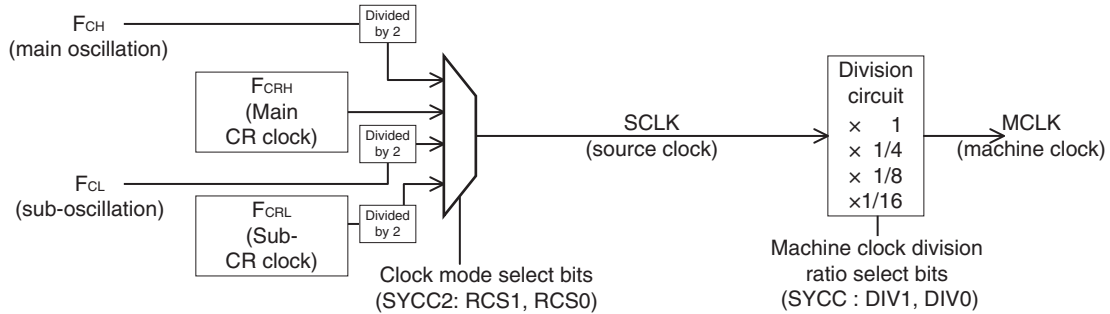

**Operating voltage - Operating frequency (When $T_A = -40^\circ\text{C}$ to $+85^\circ\text{C}$)
MB95260H/270H/280H (without the on-chip debug function)**

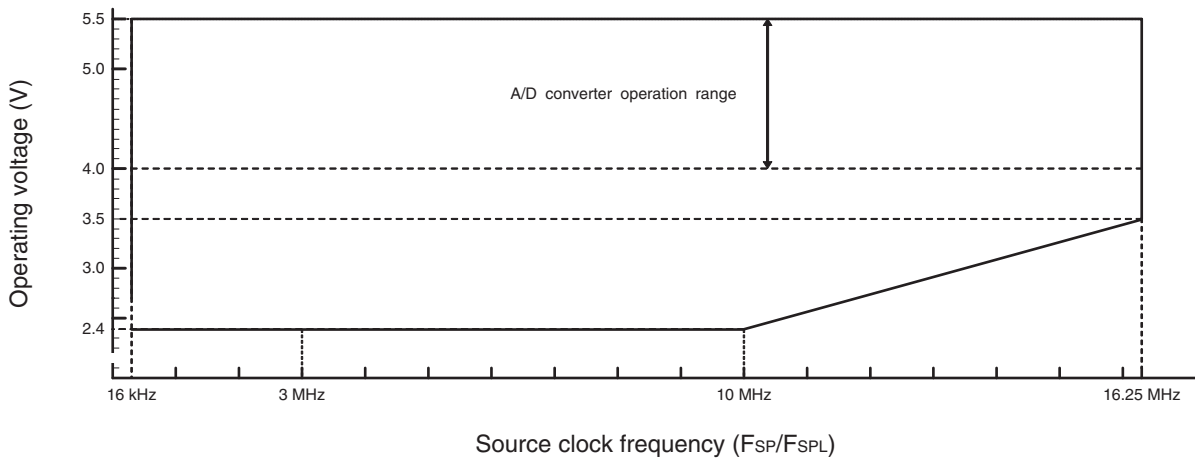

**Operating voltage - Operating frequency (When $T_A = -40^\circ\text{C}$ to $+85^\circ\text{C}$)
MB95260H/270H/280H (with the on-chip debug function)**

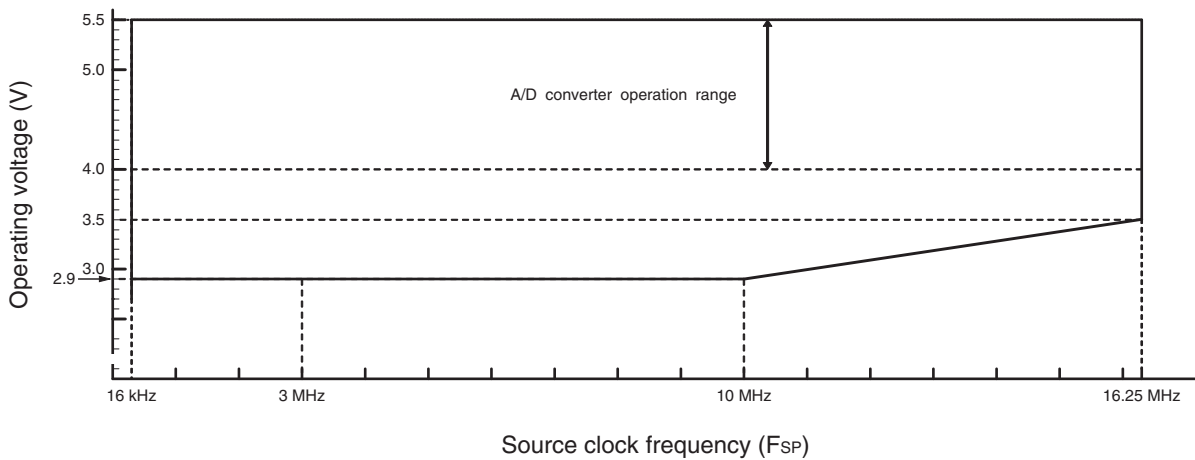

24.4.3 External Reset

($V_{CC} = 5.0 V \pm 10\%$, $V_{SS} = 0.0 V$, $T_A = -40^\circ C$ to $+85^\circ C$)

Parameter	Symbol	Value		Unit	Remarks
		Min	Max		
\overline{RST} "L" level pulse width	t_{RSTL}	$2 t_{MCLK}^{*1}$	—	ns	In normal operation
		Oscillation time of the oscillator ^{*2} + 100	—	μs	In stop mode, subclock mode, sub-sleep mode, watch mode, and power-on
		100	—	μs	In time-base timer mode

*1 : See "24.4.2. Source Clock / Machine Clock" for t_{MCLK} .

*2 : The oscillation time of an oscillator is the time for it to reach 90% of its amplitude. The crystal oscillator has an oscillation time of between several ms and tens of ms. The ceramic oscillator has an oscillation time of between hundreds of μs and several ms. The external clock has an oscillation time of 0 ms. The CR oscillator clock has an oscillation time of between several μs and several ms.

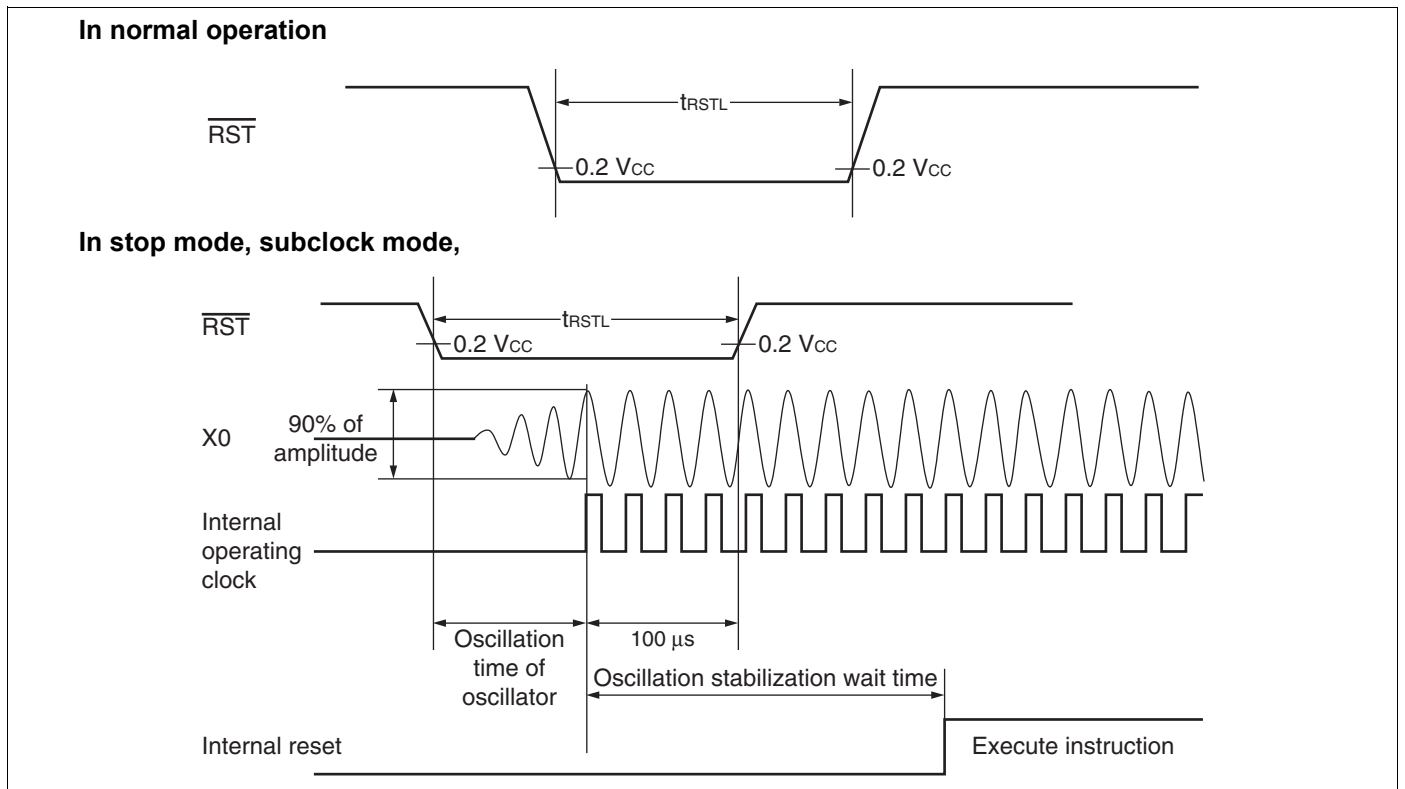

24.4.4 Power-on Reset

($V_{SS} = 0.0\text{ V}$, $T_A = -40^\circ\text{C}$ to $+85^\circ\text{C}$)

Parameter	Symbol	Condition	Value		Unit	Remarks
			Min	Max		
Power supply rising time	t_R	—	—	50	ms	
Power supply cutoff time	t_{OFF}	—	1	—	ms	Wait time until power-on

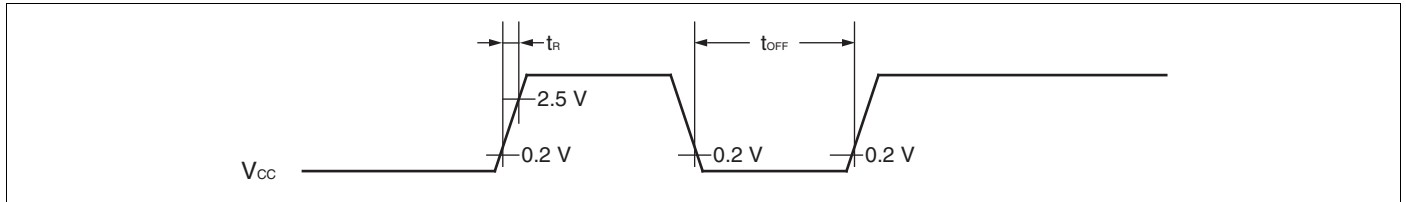

Note: A sudden change of power supply voltage may activate the power-on reset function. When changing the power supply voltage during the operation, set the slope of rising to a value below within 30 mV/ms as shown below.

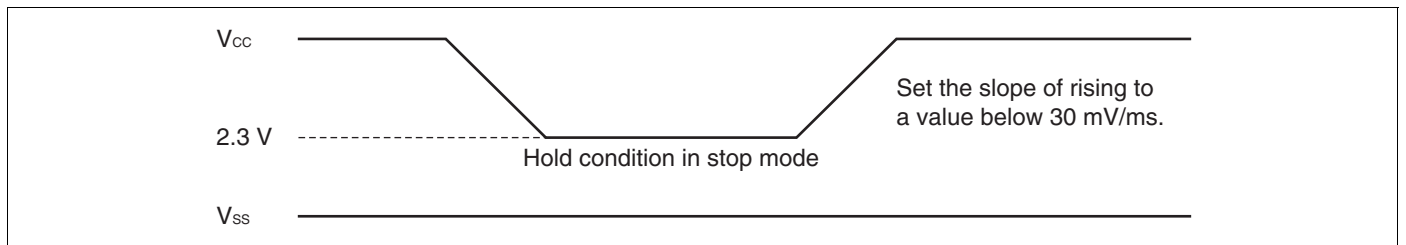

24.4.5 Peripheral Input Timing
 $(V_{CC} = 5.0 V \pm 10\%, V_{SS} = 0.0 V, T_A = -40^\circ C \text{ to } +85^\circ C)$

Parameter	Symbol	Pin name	Value		Unit
			Min	Max	
Peripheral input "H" pulse width	t_{ILIH}	INT02 to INT07 ^{*2,*3} , EC0 ^{*2} , EC1 ^{*4}	$2 t_{MCLK}^{*1}$	—	ns
Peripheral input "L" pulse width	t_{IHIL}		$2 t_{MCLK}^{*1}$	—	ns

*1: See "24.4.2. Source Clock / Machine Clock" for t_{MCLK} .

*2: INT04, INT06 and EC0 are available in all products.

*3: INT02, INT03, INT05 and INT07 are only available on MB95F262H/F262K/F263H/F263K/F264H/F264K/F282H/F282K/F283H/F283K/F284H/F284K.

*4: EC1 is only available on MB95F262H/F262K/F263H/F263K/F264H/F264K.

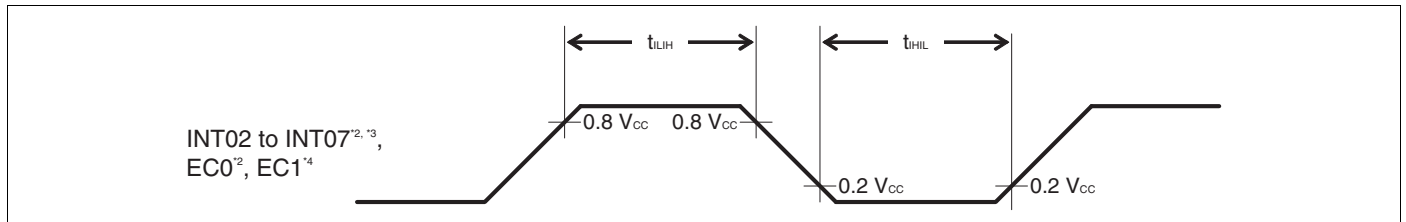

24.4.6 LIN-UART Timing (only available on MB95F262H/F262K/F263H/F263K/F264H/F264K/F282H/F282K/F283H/F283K/F284H/F284K)

Sampling is executed at the rising edge of the sampling clock*1, and serial clock delay is disabled*2.
(ESCR register: SCES bit = 0, ECCR register: SCDE bit = 0)

($V_{CC} = 5.0 V \pm 10\%$, $AV_{SS} = V_{SS} = 0.0 V$, $T_A = -40^\circ C$ to $+85^\circ C$)

Parameter	Symbol	Pin name	Condition	Value		Unit
				Min	Max	
Serial clock cycle time	t_{SCYC}	SCK	Internal clock operation output pin: $C_L = 80 \text{ pF} + 1 \text{ TTL}$	$5 t_{MCLK}^{*3}$	—	ns
SCK $\downarrow \rightarrow$ SOT delay time	t_{SLOVI}	SCK, SOT		- 95	+ 95	ns
Valid SIN \rightarrow SCK \uparrow	t_{IVSHI}	SCK, SIN		$t_{MCLK}^{*3} + 190$	—	ns
SCK $\uparrow \rightarrow$ valid SIN hold time	t_{SHIXI}	SCK, SIN		0	—	ns
Serial clock "L" pulse width	t_{SLSH}	SCK	External clock operation output pin: $C_L = 80 \text{ pF} + 1 \text{ TTL}$	$3 t_{MCLK}^{*3} - t_R$	—	ns
Serial clock "H" pulse width	t_{SHSL}	SCK		$t_{MCLK}^{*3} + 95$	—	ns
SCK $\downarrow \rightarrow$ SOT delay time	t_{SLOVE}	SCK, SOT		—	$2 t_{MCLK}^{*3} + 95$	ns
Valid SIN \rightarrow SCK \uparrow	t_{IVSHE}	SCK, SIN		190	—	ns
SCK $\uparrow \rightarrow$ valid SIN hold time	t_{SHIXE}	SCK, SIN		$t_{MCLK}^{*3} + 95$	—	ns
SCK fall time	t_F	SCK		—	10	ns
SCK rise time	t_R	SCK		—	10	ns

*1: There is a function used to choose whether the sampling of reception data is performed at a rising edge or a falling edge of the serial clock.

*2: The serial clock delay function is a function used to delay the output signal of the serial clock for half the clock.

*3: See "24.4.2. Source Clock / Machine Clock" for t_{MCLK} .

Internal shift clock mode

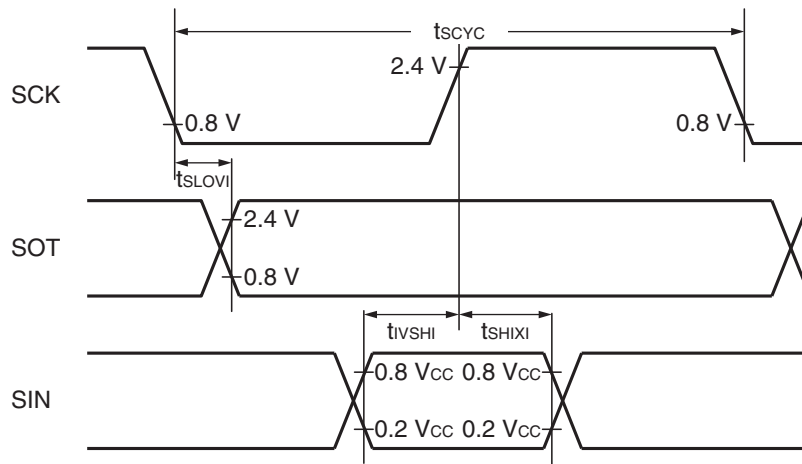

External shift clock mode

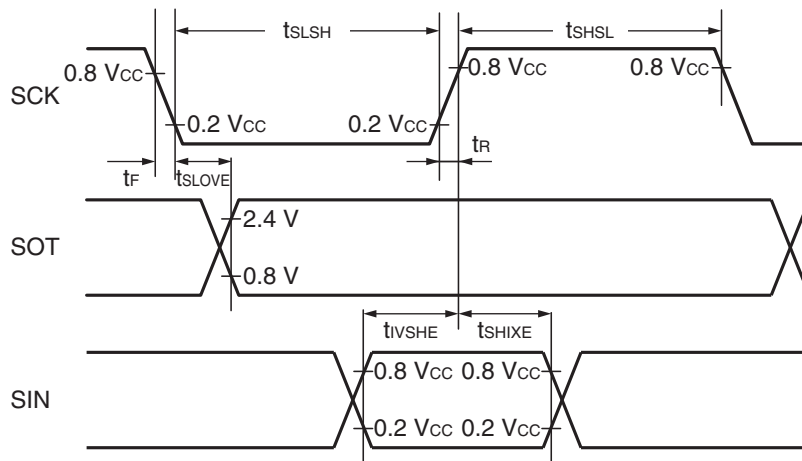

Sampling is executed at the falling edge of the sampling clock*1, and serial clock delay is disabled*2.
 (ESCR register: SCES bit = 1, ECCR register: SCDE bit = 0)

($V_{CC} = 5.0\text{ V} \pm 10\%$, $V_{SS} = 0.0\text{ V}$, $T_A = -40^\circ\text{C}$ to $+85^\circ\text{C}$)

Parameter	Symbol	Pin name	Condition	Value		Unit
				Min	Max	
Serial clock cycle time	t_{SCYC}	SCK	Internal clock operation output pin: $C_L = 80\text{ pF} + 1\text{ TTL}$	$5 t_{MCLK}^{*3}$	—	ns
SCK $\uparrow \rightarrow$ SOT delay time	t_{SHOVI}	SCK, SOT		- 95	+ 95	ns
Valid SIN \rightarrow SCK \downarrow	t_{IVSLI}	SCK, SIN		$t_{MCLK}^{*3} + 190$	—	ns
SCK $\downarrow \rightarrow$ valid SIN hold time	t_{SLIXI}	SCK, SIN		0	—	ns
Serial clock "H" pulse width	t_{SHSL}	SCK	External clock operation output pin: $C_L = 80\text{ pF} + 1\text{ TTL}$	$3 t_{MCLK}^{*3} - t_R$	—	ns
Serial clock "L" pulse width	t_{SLSH}	SCK		$t_{MCLK}^{*3} + 95$	—	ns
SCK $\uparrow \rightarrow$ SOT delay time	t_{SHOVE}	SCK, SOT		—	$2 t_{MCLK}^{*3} + 95$	ns
Valid SIN \rightarrow SCK \downarrow	t_{IVSLE}	SCK, SIN		190	—	ns
SCK $\downarrow \rightarrow$ valid SIN hold time	t_{SLIXE}	SCK, SIN		$t_{MCLK}^{*3} + 95$	—	ns
SCK fall time	t_F	SCK		—	10	ns
SCK rise time	t_R	SCK		—	10	ns

*1: There is a function used to choose whether the sampling of reception data is performed at a rising edge or a falling edge of the serial clock.

*2: The serial clock delay function is a function used to delay the output signal of the serial clock for half the clock.

*3: See "24.4.2. Source Clock / Machine Clock" for t_{MCLK} .

Internal shift clock mode

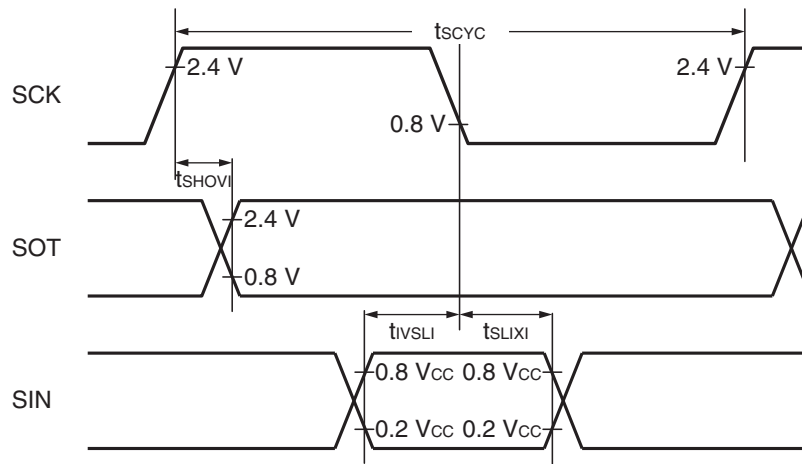

External shift clock mode

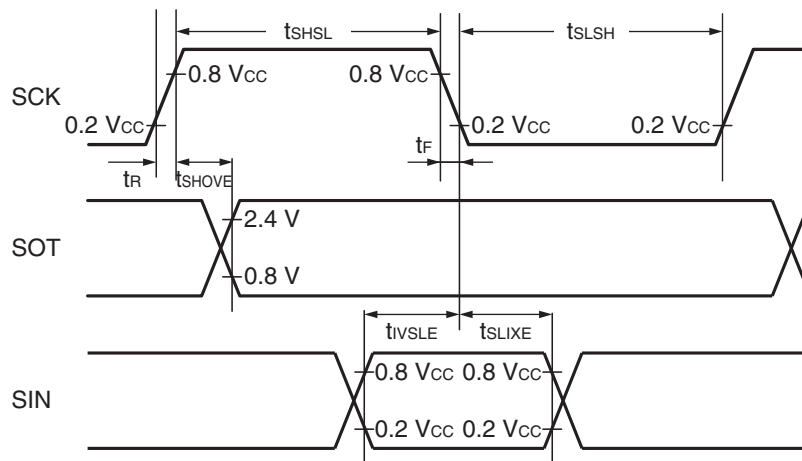

Sampling is executed at the rising edge of the sampling clock*1, and serial clock delay is enabled*2.
 (ESCR register: SCES bit = 0, ECCR register: SCDE bit = 1)

($V_{CC} = 5.0\text{ V} \pm 10\%$, $V_{SS} = 0.0\text{ V}$, $T_A = -40^\circ\text{C}$ to $+85^\circ\text{C}$)

Parameter	Symbol	Pin name	Condition	Value		Unit
				Min	Max	
Serial clock cycle time	t_{SCYC}	SCK	Internal clock operation output pin: $C_L = 80\text{ pF} + 1\text{ TTL}$	$5 t_{MCLK}^{*3}$	—	ns
SCK $\uparrow \rightarrow$ SOT delay time	t_{SHOVI}	SCK, SOT		- 95	+ 95	ns
Valid SIN \rightarrow SCK \downarrow	t_{IVSLI}	SCK, SIN		$t_{MCLK}^{*3} + 190$	—	ns
SCK $\downarrow \rightarrow$ valid SIN hold time	t_{SLIXI}	SCK, SIN		0	—	ns
SOT \rightarrow SCK \downarrow delay time	t_{SOVLI}	SCK, SOT		—	$4 t_{MCLK}^{*3}$	ns

*1: There is a function used to choose whether the sampling of reception data is performed at a rising edge or a falling edge of the serial clock.

*2: The serial clock delay function is a function that delays the output signal of the serial clock for half clock.

*3: See “24.4.2. Source Clock / Machine Clock” for t_{MCLK} .

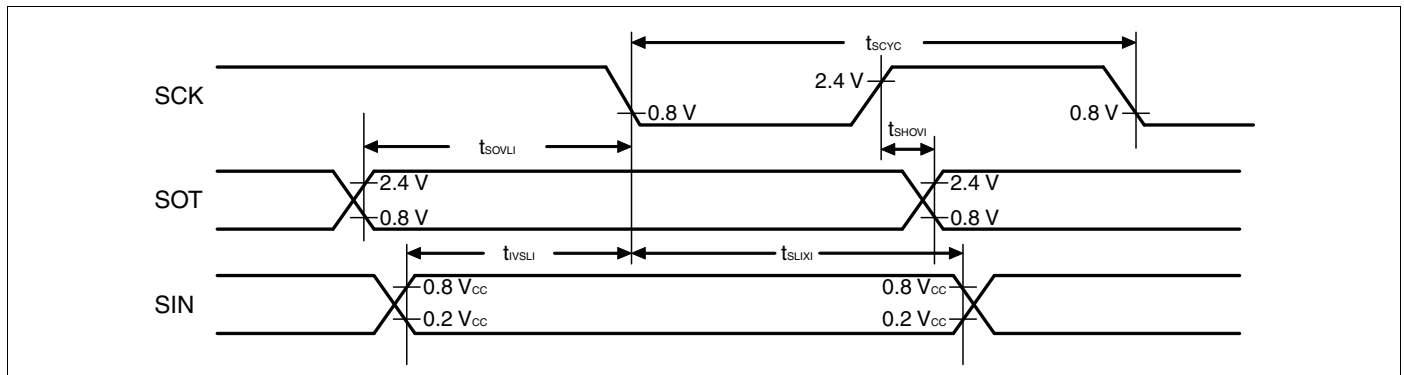

Sampling is executed at the falling edge of the sampling clock*1, and serial clock delay is enabled*2.
 (ESCR register: SCES bit = 1, ECCR register: SCDE bit = 1)

($V_{CC} = 5.0\text{ V} \pm 10\%$, $V_{SS} = 0.0\text{ V}$, $T_A = -40^\circ\text{C}$ to $+85^\circ\text{C}$)

Parameter	Symbol	Pin name	Condition	Value		Unit
				Min	Max	
Serial clock cycle time	t_{SCYC}	SCK	Internal clock operating output pin: $C_L = 80\text{ pF} + 1\text{ TTL}$	$5 t_{MCLK}^{*3}$	—	ns
SCK $\downarrow \rightarrow$ SOT delay time	t_{SLOVI}	SCK, SOT		- 95	+ 95	ns
Valid SIN \rightarrow SCK \uparrow	t_{IVSHI}	SCK, SIN		$t_{MCLK}^{*3} + 190$	—	ns
SCK $\uparrow \rightarrow$ valid SIN hold time	t_{SHIXI}	SCK, SIN		0	—	ns
SOT \rightarrow SCK \uparrow delay time	t_{SOVHI}	SCK, SOT		—	$4 t_{MCLK}^{*3}$	ns

*1: There is a function used to choose whether the sampling of reception data is performed at a rising edge or a falling edge of the serial clock.

*2: The serial clock delay function is a function that delays the output signal of the serial clock for half clock.

*3: See "24.4.2. Source Clock / Machine Clock" for t_{MCLK} .

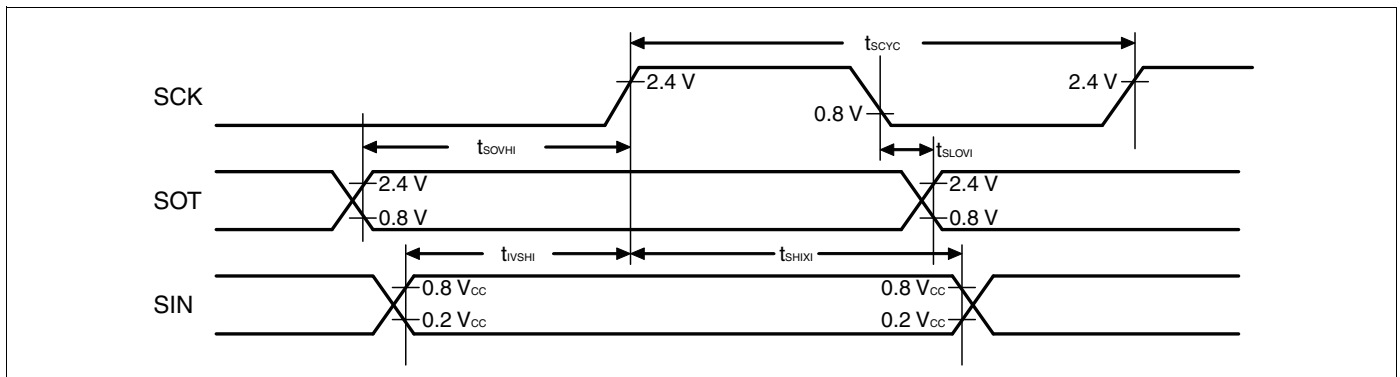

24.4.7 Low-voltage Detection

 ($V_{SS} = 0.0\text{ V}$, $T_A = -40^\circ\text{C}$ to $+85^\circ\text{C}$)

Parameter	Symbol	Value			Unit	Remarks
		Min	Typ	Max		
Release voltage	V_{DL+}	2.52	2.7	2.88	V	At power supply rise
Detection voltage	V_{DL-}	2.42	2.6	2.78	V	At power supply fall
Hysteresis width	V_{HYS}	70	100	—	mV	
Power supply start voltage	V_{off}	—	—	2.3	V	
Power supply end voltage	V_{on}	4.9	—	—	V	
Power supply voltage change time (at power supply rise)	t_r	3000	—	—	μs	Slope of power supply that the reset release signal generates within the rating (V_{DL+})
Power supply voltage change time (at power supply fall)	t_f	300	—	—	μs	Slope of power supply that the reset detection signal generates within the rating (V_{DL-})
Reset release delay time	t_{d1}	—	—	300	μs	
Reset detection delay time	t_{d2}	—	—	20	μs	

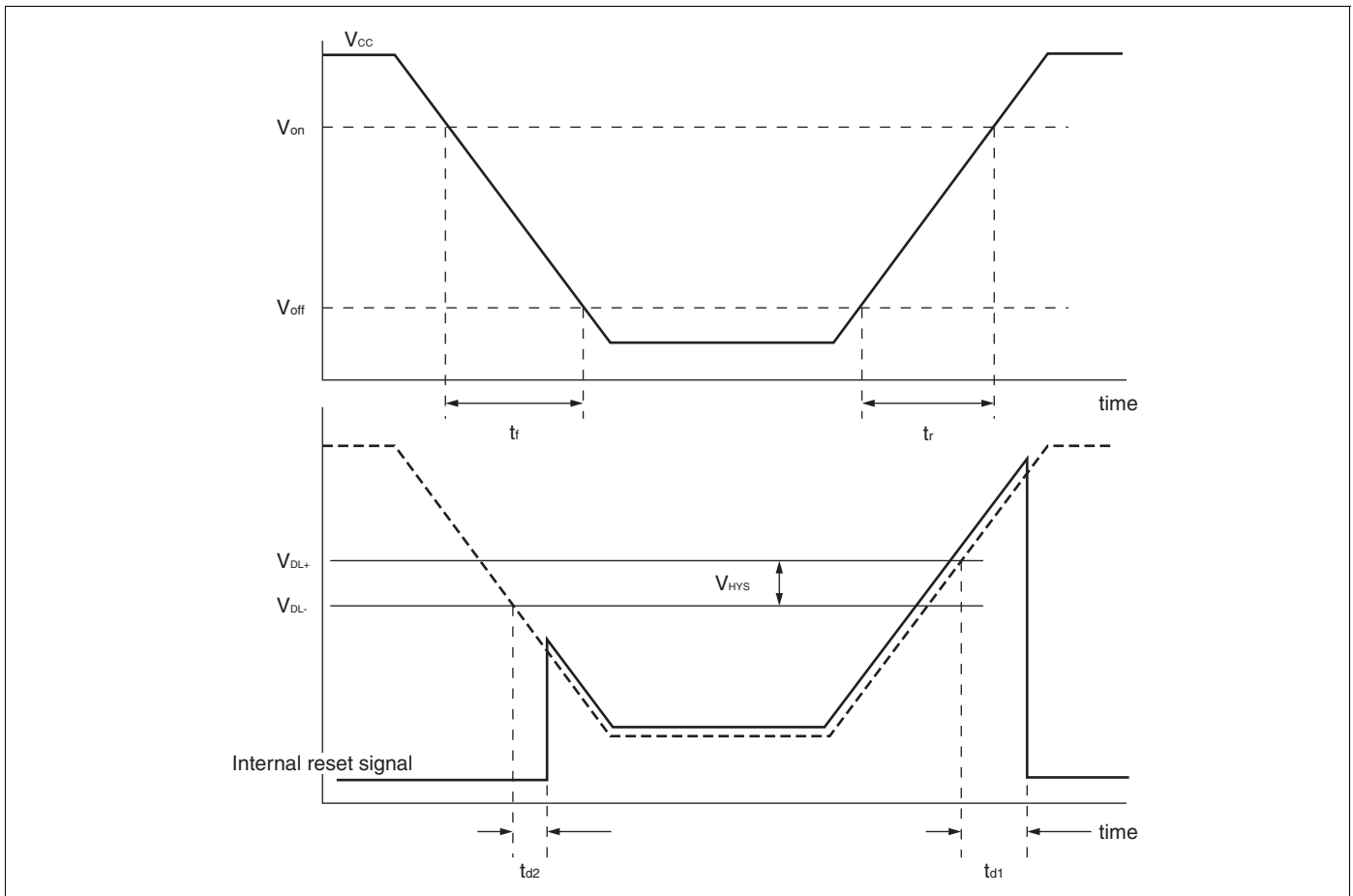

24.5 A/D Converter
24.5.1 A/D Converter Electrical Characteristics
 $(V_{CC} = 4.0\text{ V to } 5.5\text{ V}, V_{SS} = 0.0\text{ V}, T_A = -40^\circ\text{C to } +85^\circ\text{C})$

Parameter	Symbol	Value			Unit	Remarks
		Min	Typ	Max		
Resolution	—	—	—	10	bit	
Total error		- 3	—	+ 3	LSB	
Linearity error		- 2.5	—	+ 2.5	LSB	
Differential linear error		- 1.9	—	+ 1.9	LSB	
Zero transition voltage	V_{OT}	$V_{SS} - 1.5\text{ LSB}$	$V_{SS} + 0.5\text{ LSB}$	$V_{SS} + 2.5\text{ LSB}$	V	
Full-scale transition voltage	V_{FST}	$V_{CC} - 4.5\text{ LSB}$	$V_{CC} - 2\text{ LSB}$	$V_{CC} + 0.5\text{ LSB}$	V	
Compare time	—	0.9	—	16500	μs	$4.5\text{ V} \leq V_{CC} \leq 5.5\text{ V}$
		1.8	—	16500	μs	$4.0\text{ V} \leq V_{CC} < 4.5\text{ V}$
Sampling time	—	0.6	—	∞	μs	$4.5\text{ V} \leq V_{CC} \leq 5.5\text{ V}$, with external impedance < 5.4 k Ω
		1.2	—	∞	μs	$4.0\text{ V} \leq V_{CC} < 4.5\text{ V}$, with external impedance < 2.4 k Ω
Analog input current	I_{AIN}	- 0.3	—	+ 0.3	μA	
Analog input voltage	V_{AIN}	V_{SS}	—	V_{CC}	V	

24.5.2 Notes on Using the A/D Converter

External impedance of analog input and its sampling time

The A/D converter has a sample and hold circuit. If the external impedance is too high to keep sufficient sampling time, the analog voltage charged to the capacitor of the internal sample and hold circuit is insufficient, adversely affecting A/D conversion precision. Therefore, to satisfy the A/D conversion precision standard, considering the relationship between the external impedance and minimum sampling time, either adjust the register value and operating frequency or decrease the external impedance so that the sampling time is longer than the minimum value. In addition, if sufficient sampling time cannot be secured, connect a capacitor of about 0.1 μF to the analog input pin.

Analog input equivalent circuit

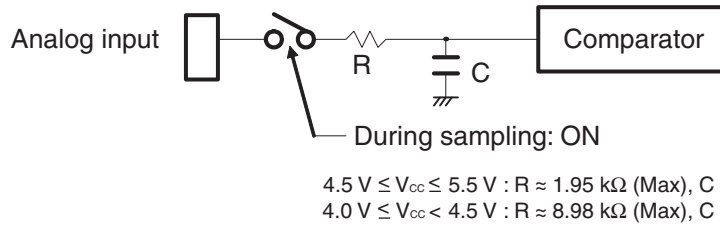

Note: The values are reference values.

Relationship between external impedance and minimum sampling time

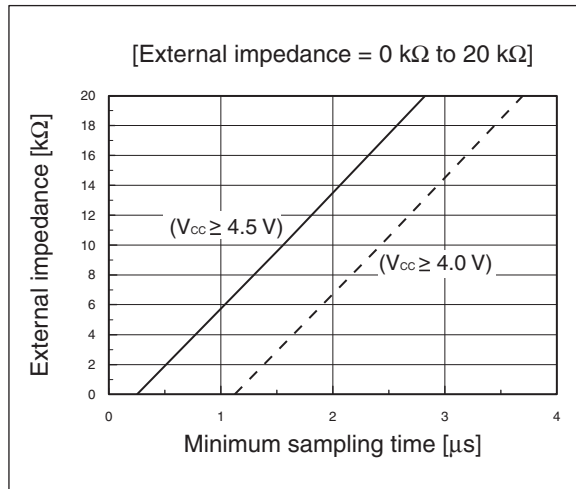
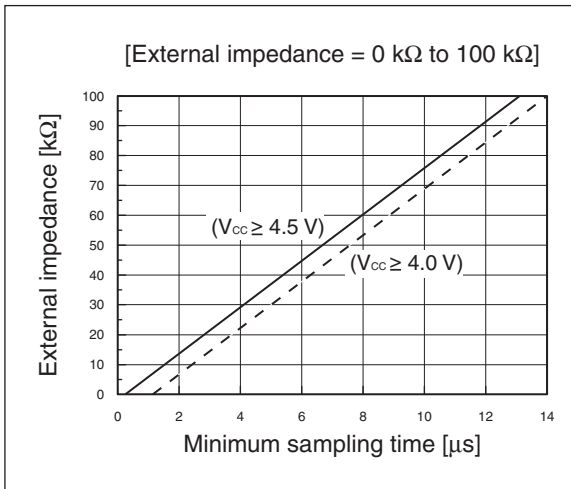

A/D conversion error

As $|V_{CC}-V_{SS}|$ decreases, the A/D conversion error increases proportionately.

24.5.3 Definitions of A/D Converter Terms

Resolution

It indicates the level of analog variation that can be distinguished by the A/D converter. When the number of bits is 10, analog voltage can be divided into $2^{10} = 1024$.

Linearity error (unit: LSB)

It indicates how much an actual conversion value deviates from the straight line connecting the zero transition point ("00 0000 0000" \leftrightarrow "00 0000 0001") of a device to the full-scale transition point ("11 1111 1111" \leftrightarrow "11 1111 1110") of the same device.

Differential linear error (unit: LSB)

It indicates how much the input voltage required to change the output code by 1 LSB deviates from an ideal value.

Total error (unit: LSB)

It indicates the difference between an actual value and a theoretical value. The error can be caused by a zero transition error, a full-scale transition errors, a linearity error, a quantum error, or noise.

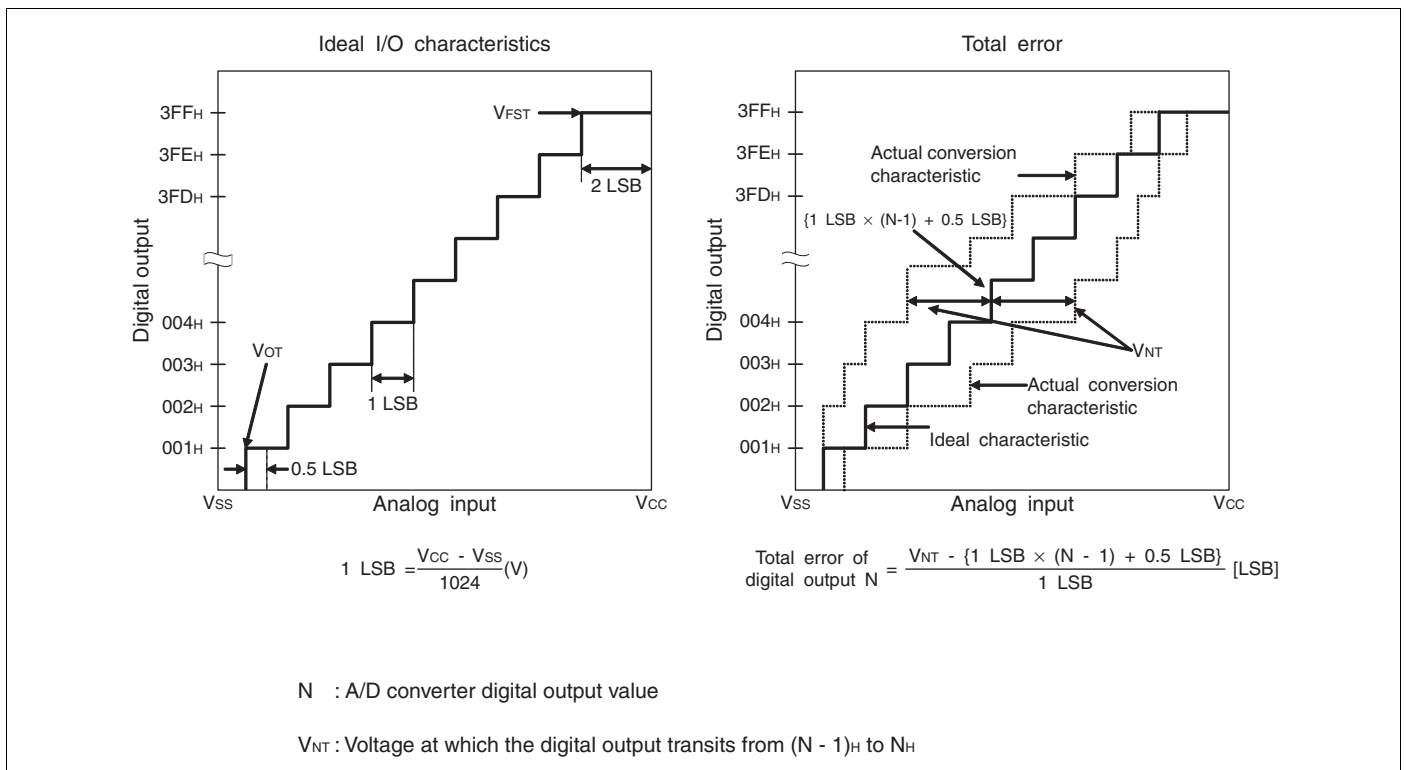

(Continued)

(Continued)

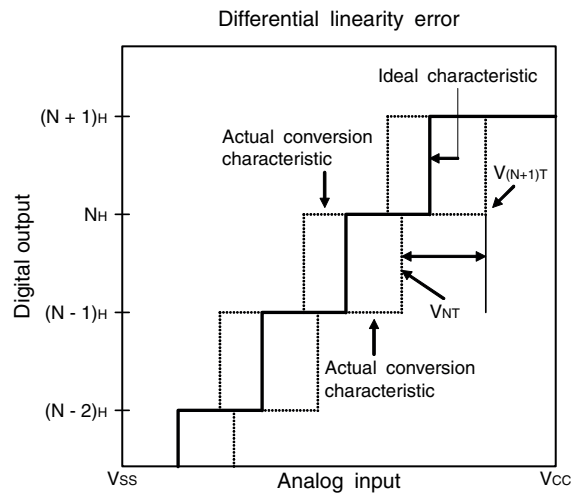
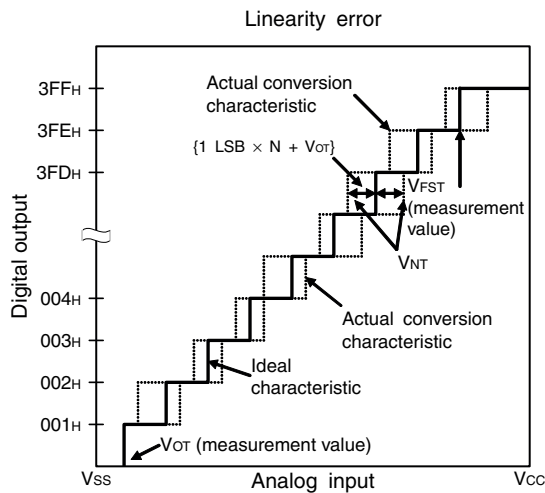
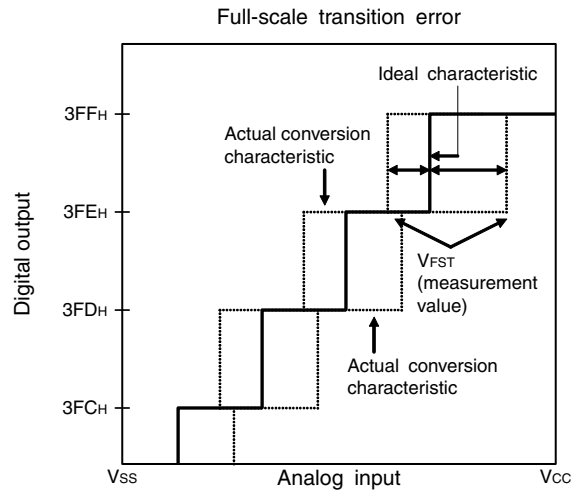
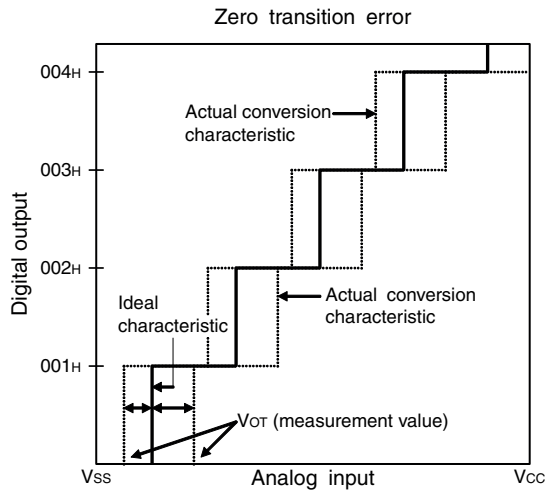

$$\text{Linearity error of digital output } N = \frac{V_{NT} - \{1 \text{ LSB} \times N + V_{OT}\}}{1 \text{ LSB}}$$

$$\text{Differential linear error of digital output } N = \frac{V_{(N+1)T} - V_{NT}}{1 \text{ LSB}} - 1$$

N : A/D converter digital output value

V_{NT} : Voltage at which the digital output transits from $(N - 1)_H$ to N_H

V_{OT} (ideal value) = $V_{SS} + 0.5 \text{ LSB}$ [V]

V_{FST} (ideal value) = $V_{CC} - 2 \text{ LSB}$ [V]

24.6 Flash Memory Program/Erase Characteristics

Parameter	Value			Unit	Remarks
	Min	Typ	Max		
Sector erase time (2 Kbyte sector)	—	0.2* ¹	0.5* ²	s	The time of writing 00 _H prior to erasure is excluded.
Sector erase time (16 Kbyte sector)	—	0.5* ¹	7.5* ²	s	The time of writing 00 _H prior to erasure is excluded.
Byte writing time	—	21	6100* ²	μs	System-level overhead is excluded.
Program/erase cycle	100000	—	—	cycle	
Power supply voltage at program/erase	3.0	—	5.5	V	
Flash memory data retention time	20* ³	—	—	year	Average T _A = + 85°C

*1: T_A = + 25°C, V_{CC} = 5.0 V, 100000 cycles

*2: T_A = + 85°C, V_{CC} = 3.0 V, 100000 cycles

*3: This value is converted from the result of a technology reliability assessment. (The value is converted from the result of a high temperature accelerated test using the Arrhenius equation with the average temperature being + 85°C) .

25. Sample Characteristics

Power supply current temperature

I_{CC} - V_{CC}
 $T_A = +25^\circ\text{C}$ $F_{MP} = 2, 4, 8, 10, 16$ MHz (divided by 2)
 Main clock mode with the external clock operating

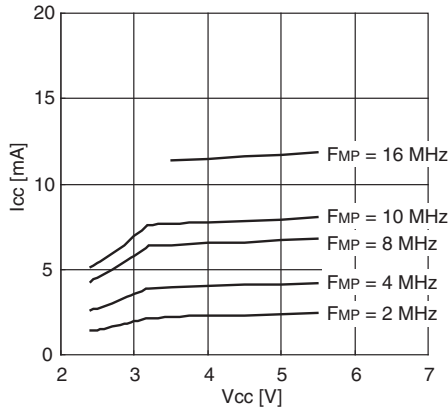

I_{CC} - T_A
 $V_{CC} = 5.5$ V $F_{MP} = 10, 16$ MHz (divided by 2)
 Main clock mode with the external clock operating

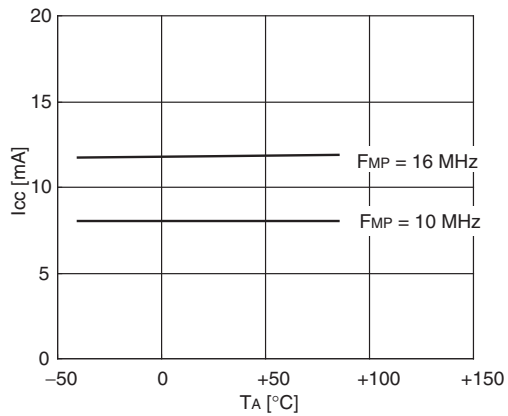

I_{CCS} - V_{CC}
 $T_A = +25^\circ\text{C}$ $F_{MP} = 2, 4, 8, 10, 16$ MHz (divided by 2)
 Main sleep mode with the external clock operating

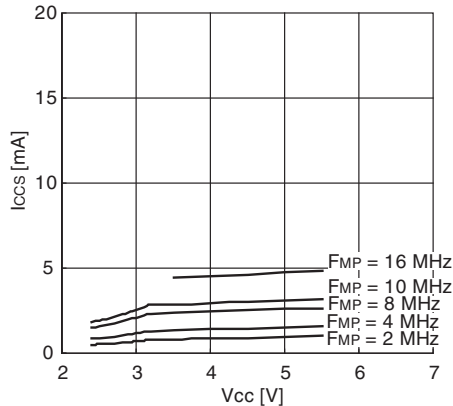

I_{CCS} - T_A
 $V_{CC} = 5.5$ V $F_{MP} = 10, 16$ MHz (divided by 2)
 Main sleep mode with the external clock operating

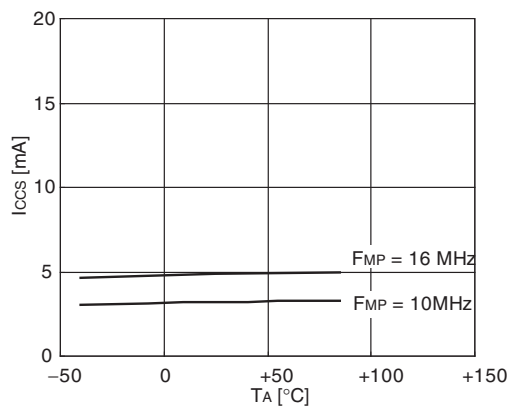

I_{CCCL} - V_{CC}
 $T_A = +25^\circ\text{C}$ $F_{MPL} = 16$ kHz (divided by 2)
 Subclock mode with the external clock operating

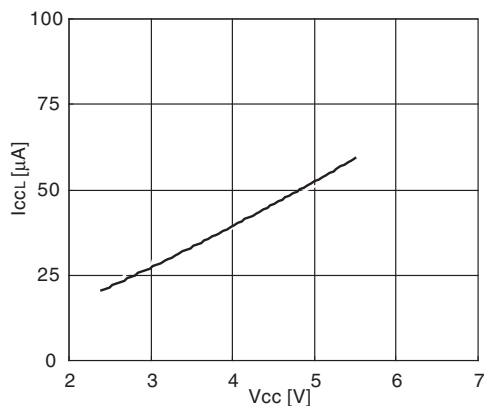

I_{CCCL} - T_A
 $V_{CC} = 5.5$ V $F_{MPL} = 16$ kHz (divided by 2)
 Subclock mode with the external clock operating

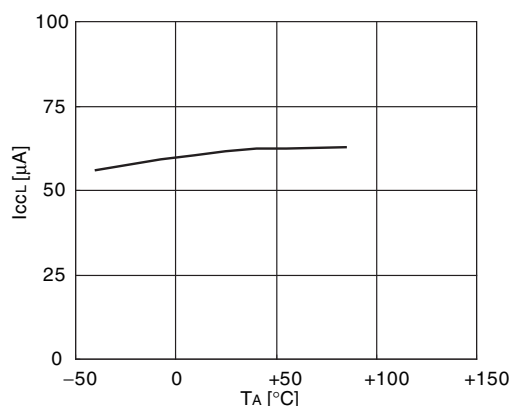

(Continued)

$I_{CCLS} - V_{CC}$
 $T_A = +25^\circ\text{C}$ $F_{MPL} = 16\text{ kHz}$ (divided by 2)
 Subsleep mode with the external clock operating

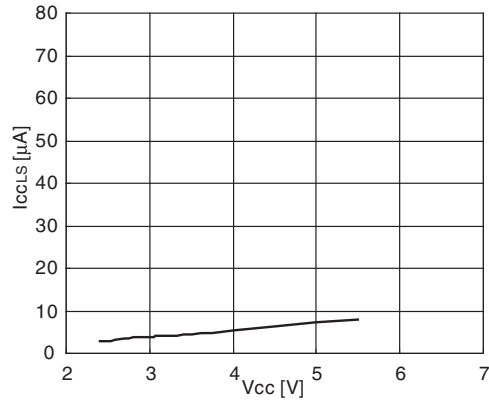

$I_{CCLS} - T_A$
 $V_{CC} = 5.5\text{ V}$ $F_{MPL} = 16\text{ kHz}$ (divided by 2)
 Subsleep mode with the external clock operating

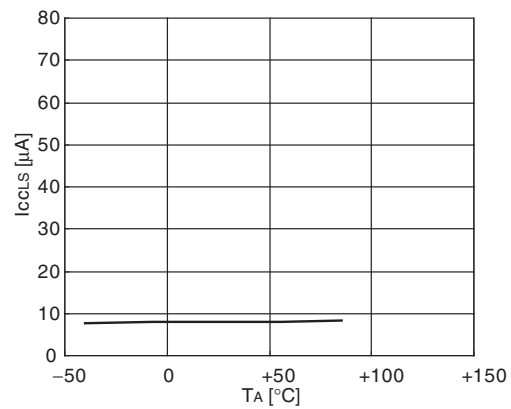

$I_{CCT} - V_{CC}$
 $T_A = +25^\circ\text{C}$ $F_{MPL} = 16\text{ kHz}$ (divided by 2)
 Watch mode with the external clock operating

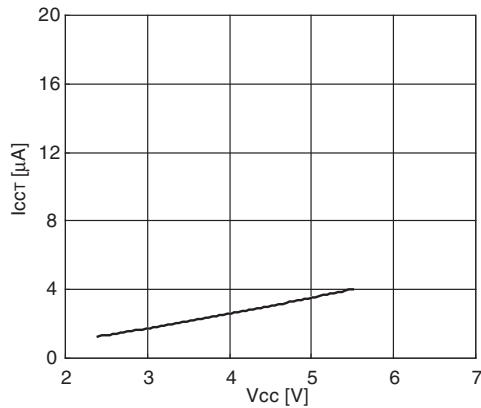

$I_{CCT} - T_A$
 $V_{CC} = 5.5\text{ V}$ $F_{MPL} = 16\text{ kHz}$ (divided by 2)
 Watch mode with the external clock operating

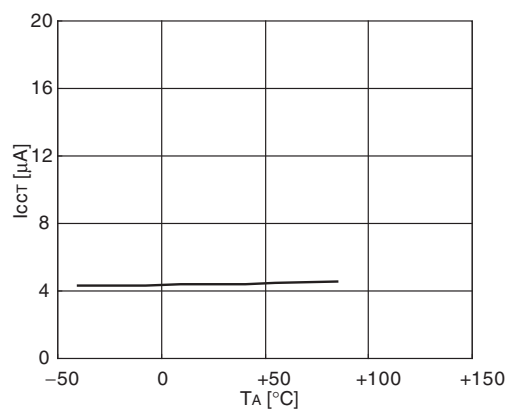

$I_{CTS} - V_{CC}$
 $T_A = +25^\circ\text{C}$ $F_{MP} = 2, 4, 8, 10, 16\text{ MHz}$ (divided by 2)
 Time-base timer mode with the external clock operating

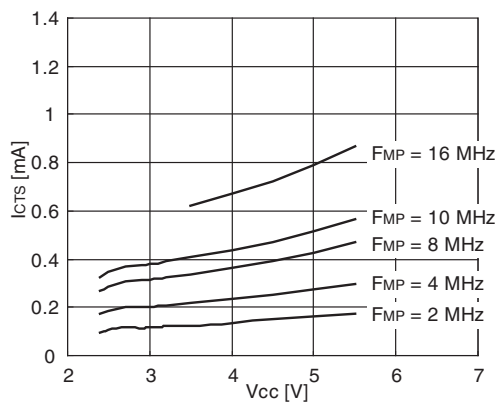

$I_{CTS} - T_A$
 $V_{CC} = 5.5\text{ V}$ $F_{MP} = 10, 16\text{ MHz}$ (divided by 2)
 Time-base timer mode with the external clock operating

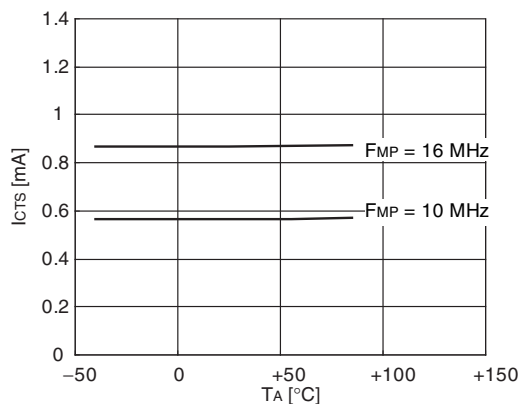

(Continued)

(Continued)

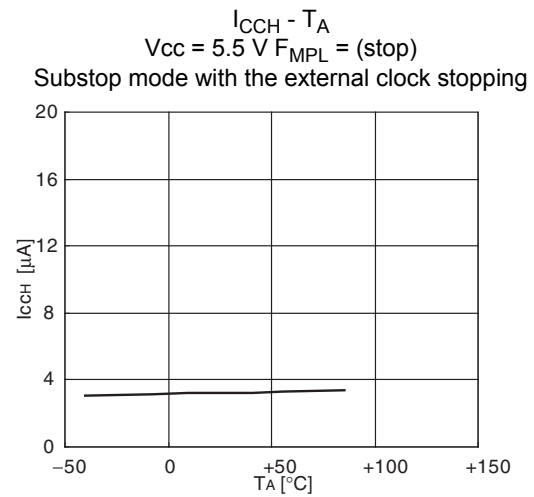
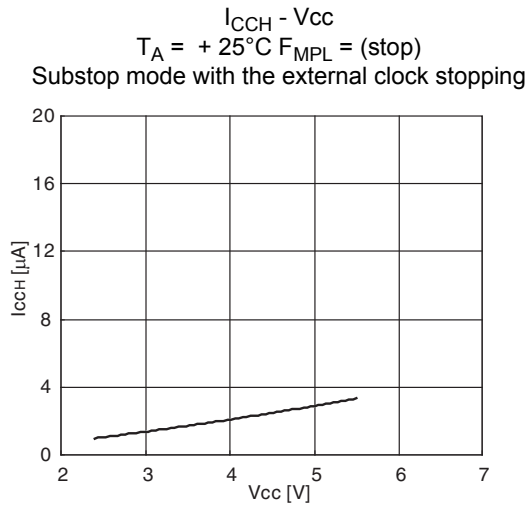

$I_{CCMCR} - V_{CC}$
 $T_A = +25^\circ\text{C}$ $F_{MP} = 1, 8, 10\text{ MHz}$ (no division)
 Main clock mode
 with the main CR clock operating

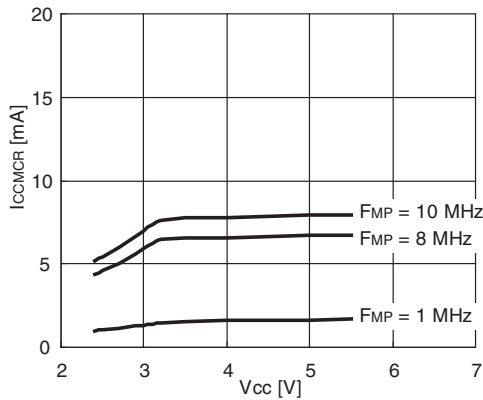

$I_{CCMCR} - T_A$
 $V_{CC} = 5.5\text{ V}$ $F_{MP} = 1, 8, 10\text{ MHz}$ (no division)
 Main clock mode
 with the main CR clock operating

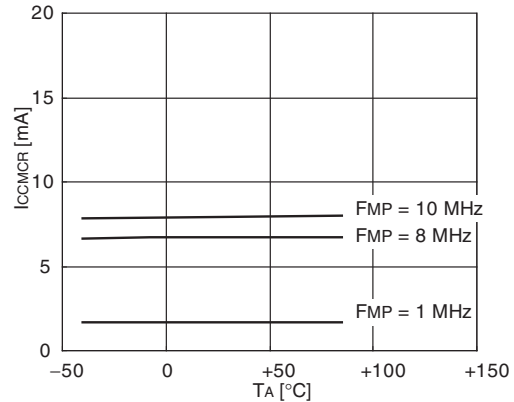

$I_{CCSCR} - V_{CC}$
 $T_A = +25^\circ\text{C}$ $F_{MPL} = 50\text{ kHz}$ (divided by 2)
 Subclock mode with
 the sub-CR clock operating

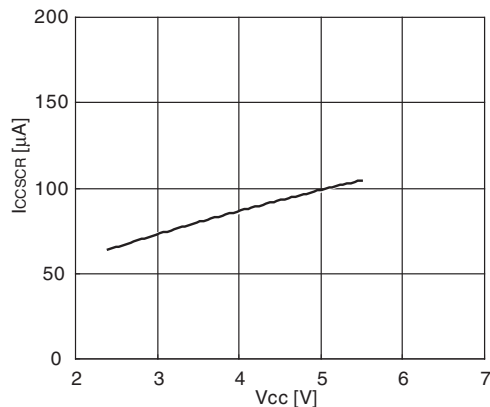

$I_{CCSCR} - T_A$
 $V_{CC} = 5.5\text{ V}$ $F_{MPL} = 50\text{ kHz}$ (divided by 2)
 Subclock mode with
 the sub-CR clock operating

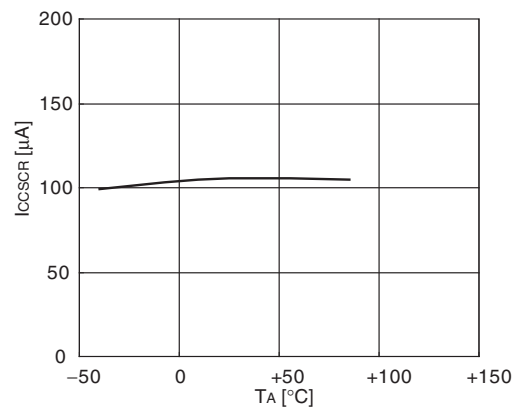

Input voltage

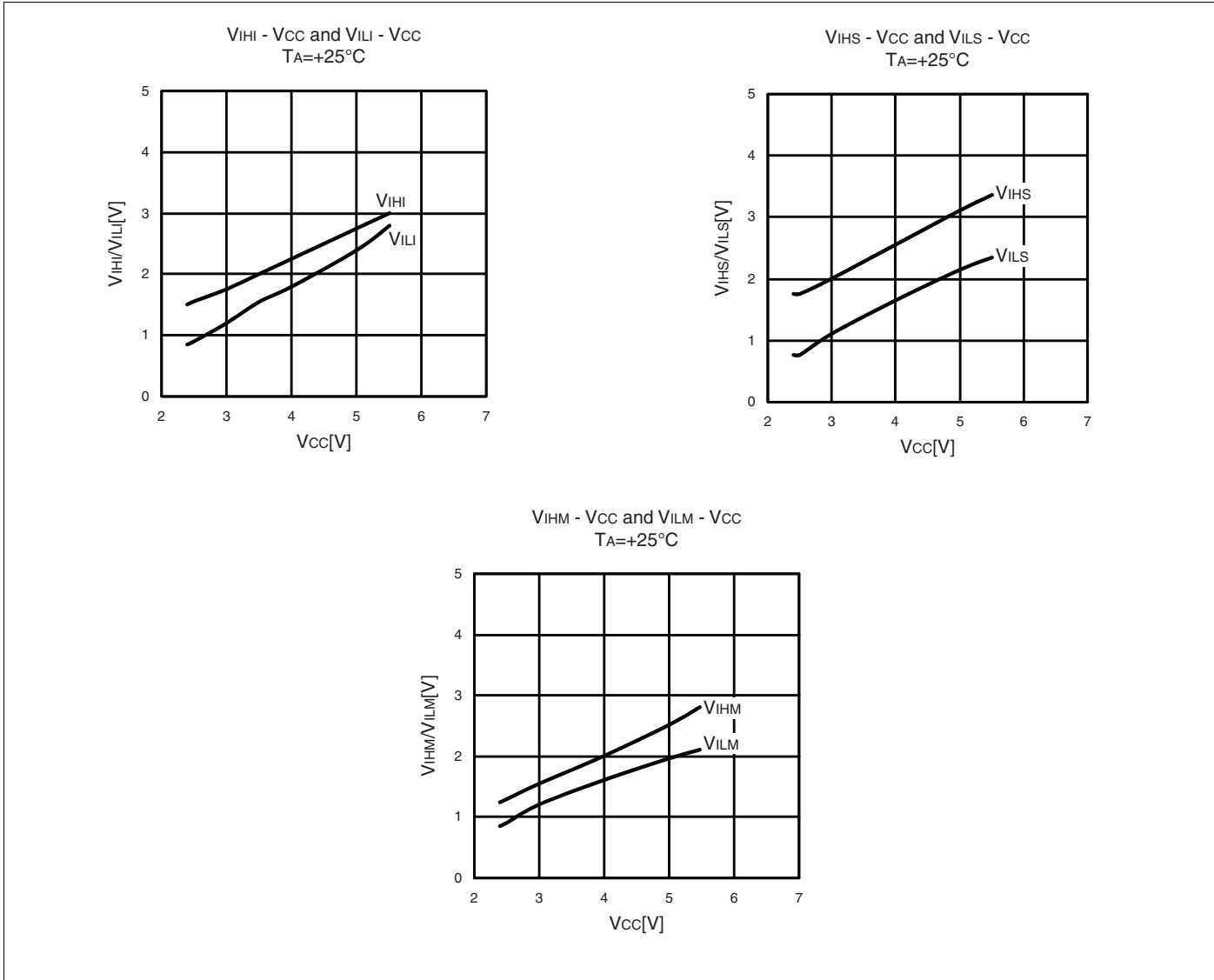

Output voltage

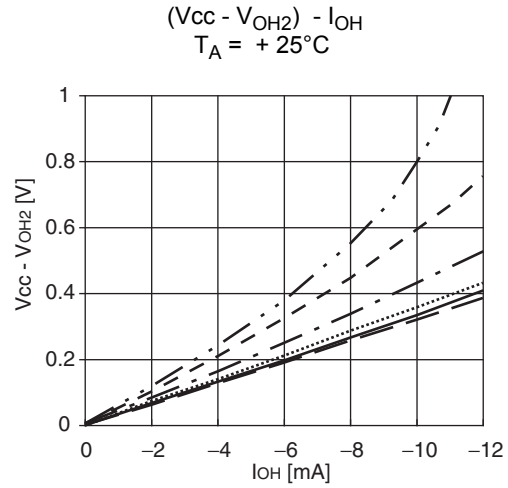
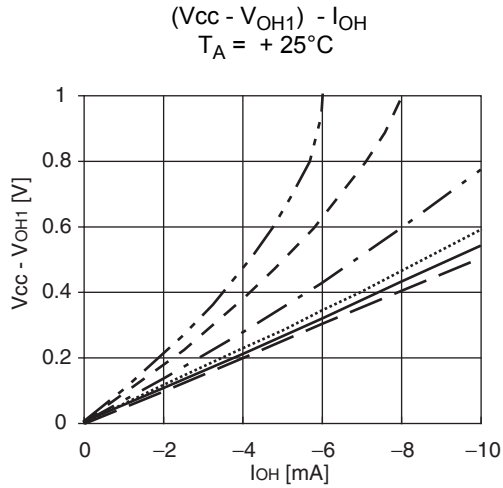

- Vcc = 2.4 V
- - - Vcc = 2.7 V
- . - Vcc = 3.5 V
- Vcc = 4.5 V
- _____ Vcc = 5.0 V
- Vcc = 5.5 V

- Vcc = 2.4 V
- - - Vcc = 2.7 V
- . - Vcc = 3.5 V
- Vcc = 4.5 V
- _____ Vcc = 5.0 V
- Vcc = 5.5 V

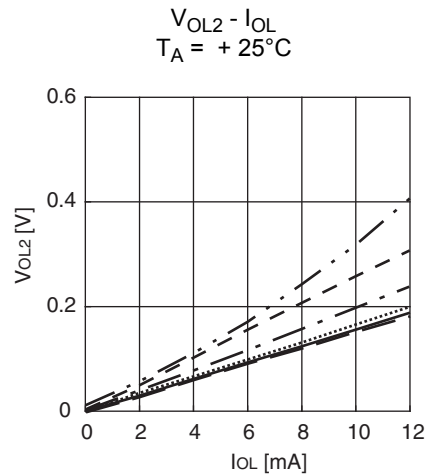
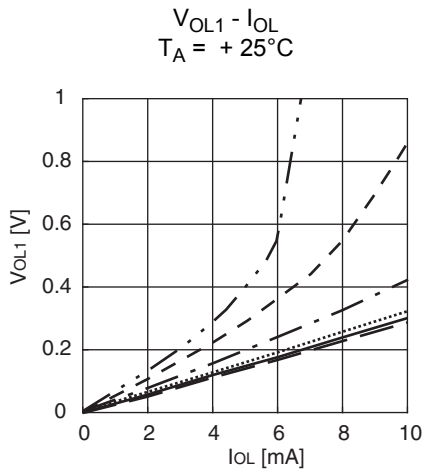

- Vcc = 2.4 V
- - - Vcc = 2.7 V
- . - Vcc = 3.5 V
- Vcc = 4.5 V
- _____ Vcc = 5.0 V
- Vcc = 5.5 V

- Vcc = 2.4 V
- - - Vcc = 2.7 V
- . - Vcc = 3.5 V
- Vcc = 4.5 V
- _____ Vcc = 5.0 V
- Vcc = 5.5 V

Pull-up

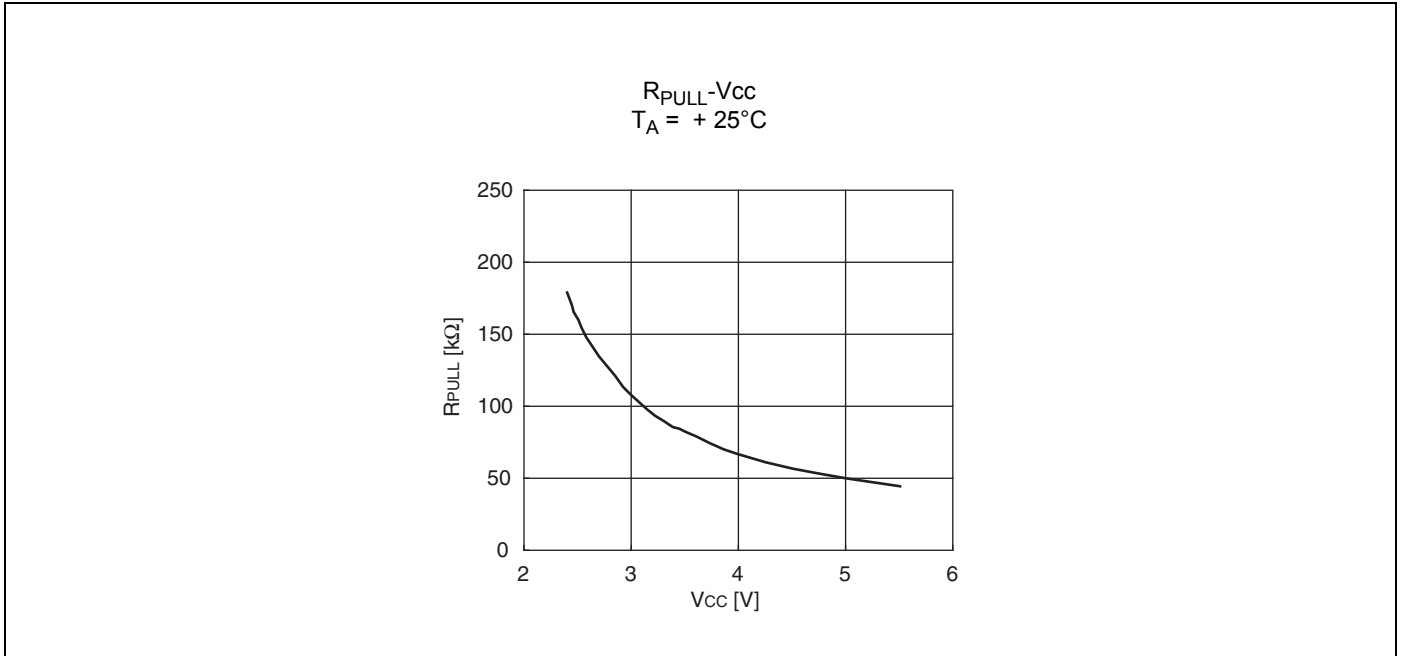

26. Mask Options

No.	Part Number	MB95F262H MB95F263H MB95F264H MB95F272H MB95F273H MB95F274H MB95F282H MB95F283H MB95F284H	MB95F262K MB95F263K MB95F264K MB95F272K MB95F273K MB95F274K MB95F282K MB95F283K MB95F284K
	Selectable/Fixed	Fixed	
1	Low-voltage detection reset	Without low-voltage detection reset	With low-voltage detection reset
2	Reset	With dedicated reset input	Without dedicated reset input

27. Ordering Information

Part Number	Package
MB95F262HWQN-G-SNE1 MB95F262HWQN-G-SNERE1 MB95F262KWQN-G-SNE1 MB95F262KWQN-G-SNERE1 MB95F263HWQN-G-SNE1 MB95F263HWQN-G-SNERE1 MB95F263KWQN-G-SNE1 MB95F263KWQN-G-SNERE1 MB95F264HWQN-G-SNE1 MB95F264HWQN-G-SNERE1 MB95F264KWQN-G-SNE1 MB95F264KWQN-G-SNERE1	32-pin plastic QFN (LCC-32P-M19)
MB95F262HP-G-SH-SNE2 MB95F262KP-G-SH-SNE2 MB95F263HP-G-SH-SNE2 MB95F263KP-G-SH-SNE2 MB95F264HP-G-SH-SNE2 MB95F264KP-G-SH-SNE2	24-pin plastic SDIP (DIP-24P-M07)
MB95F262HPF-G-SNE2 MB95F262KPF-G-SNE2 MB95F263HPF-G-SNE2 MB95F263KPF-G-SNE2 MB95F264HPF-G-SNE2 MB95F264KPF-G-SNE2	20-pin plastic SOP (FPT-20P-M09)
MB95F262HPFT-G-SNE2 MB95F262KPFT-G-SNE2 MB95F263HPFT-G-SNE2 MB95F263KPFT-G-SNE2 MB95F264HPFT-G-SNE2 MB95F264KPFT-G-SNE2	20-pin plastic TSSOP (FPT-20P-M10)
MB95F282HWQN-G-SNE1 MB95F282HWQN-G-SNERE1 MB95F282KWQN-G-SNE1 MB95F282KWQN-G-SNERE1 MB95F283HWQN-G-SNE1 MB95F283HWQN-G-SNERE1 MB95F283KWQN-G-SNE1 MB95F283KWQN-G-SNERE1 MB95F284HWQN-G-SNE1 MB95F284HWQN-G-SNERE1 MB95F284KWQN-G-SNE1 MB95F284KWQN-G-SNERE1	32-pin plastic QFN (LCC-32P-M19)
MB95F282HPH-G-SNE2 MB95F282KPH-G-SNE2 MB95F283HPH-G-SNE2 MB95F283KPH-G-SNE2 MB95F284HPH-G-SNE2 MB95F284KPH-G-SNE2	16-pin plastic DIP (DIP-16P-M06)

(Continued)

(Continued)

Part Number	Package
MB95F282HPF-G-SNE1 MB95F282KPF-G-SNE1 MB95F283HPF-G-SNE1 MB95F283KPF-G-SNE1 MB95F284HPF-G-SNE1 MB95F284KPF-G-SNE1	16-pin plastic SOP (FPT-16P-M06)
MB95F272HPH-G-SNE2 MB95F272KPH-G-SNE2 MB95F273HPH-G-SNE2 MB95F273KPH-G-SNE2 MB95F274HPH-G-SNE2 MB95F274KPH-G-SNE2	8-pin plastic DIP (DIP-8P-M03)
MB95F272HPF-G-SNE2 MB95F272KPF-G-SNE2 MB95F273HPF-G-SNE2 MB95F273KPF-G-SNE2 MB95F274HPF-G-SNE2 MB95F274KPF-G-SNE2	8-pin plastic SOP (FPT-8P-M08)

28. Package Dimension

<p style="text-align: center;">(DIP-24P-M07)</p>	Lead pitch	1.778 mm	
	Package width × package length	6.40 mm × 22.86 mm	
	Sealing method	Plastic mold	
	Mounting height	4.80 mm Max	

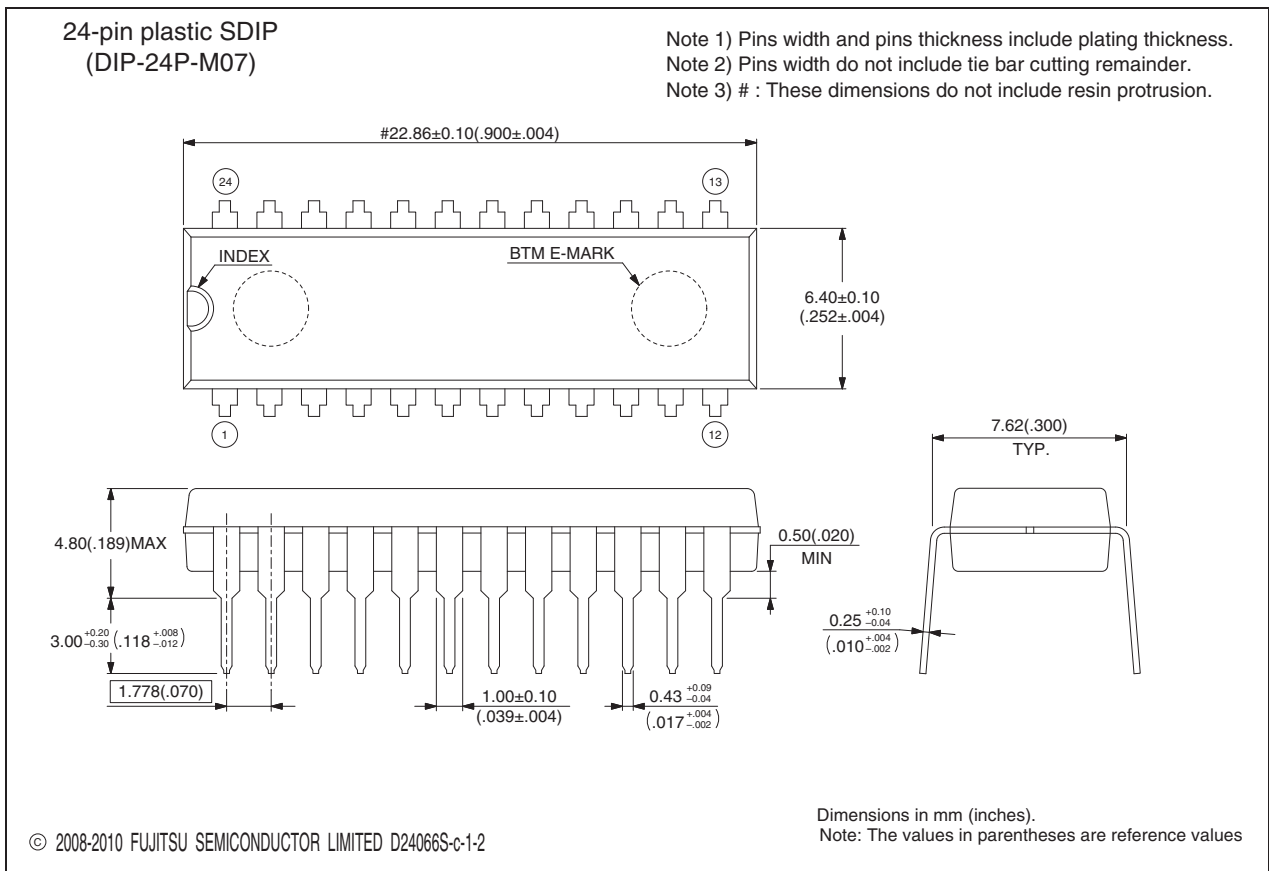

(Continued)

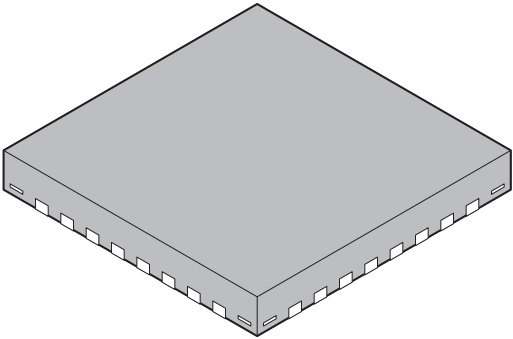
<p style="text-align: center;">32-pin plastic QFN</p>  <p style="text-align: center;">(LCC-32P-M19)</p>	Lead pitch	0.50 mm	
	Package width × package length	5.00 mm × 5.00 mm	
	Sealing method	Plastic mold	
	Mounting height	0.80 mm MAX	
	Weight	0.06 g	

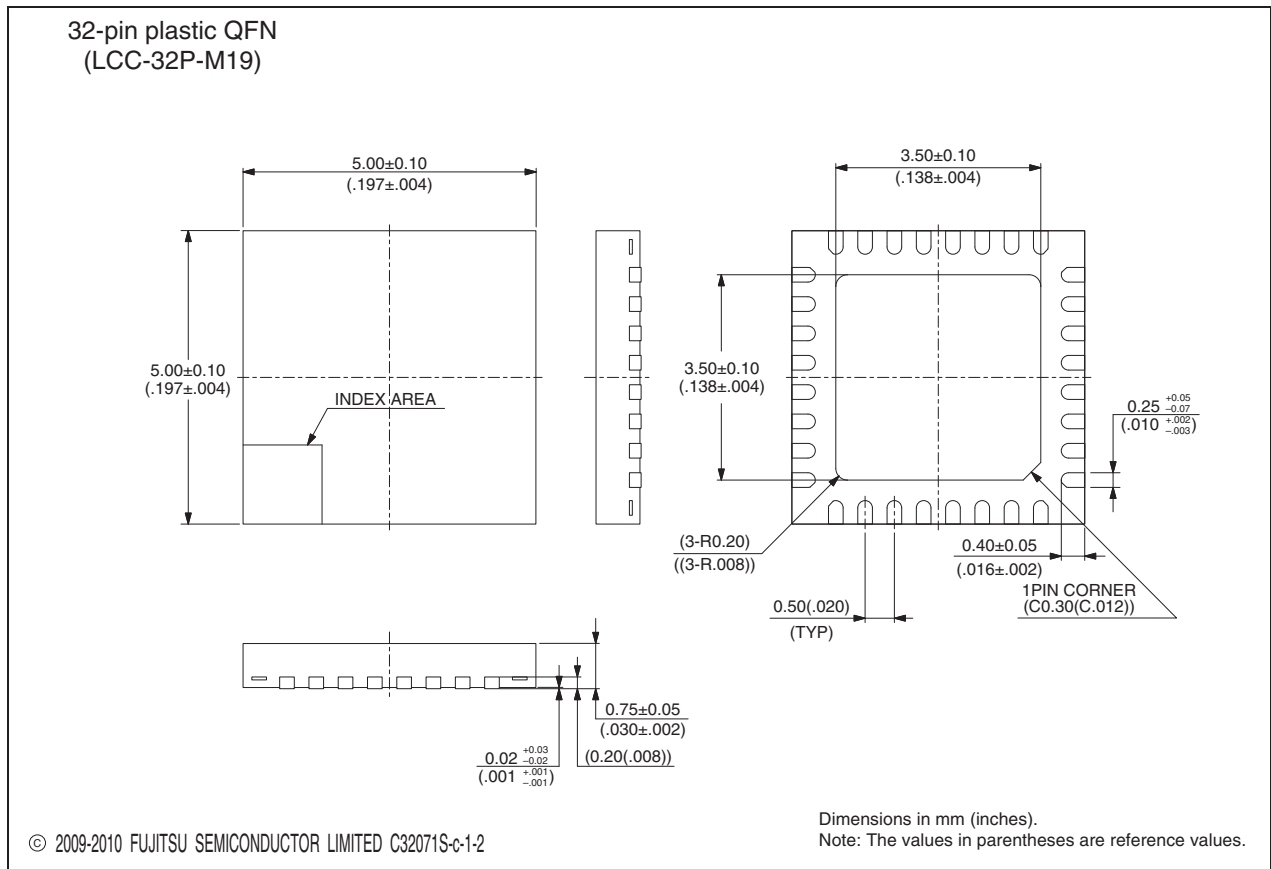

(Continued)

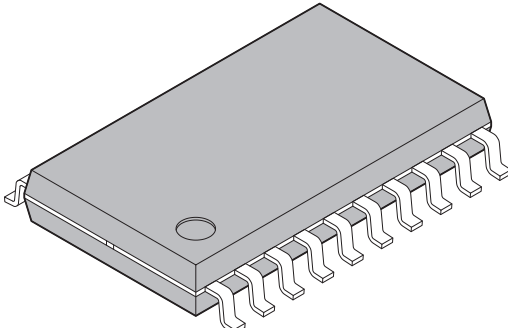
<p style="text-align: center;">20-pin plastic SOP</p>  <p style="text-align: center;">(FPT-20P-M09)</p>	Lead pitch	1.27 mm
	Package width × package length	7.50 mm × 12.70 mm
	Lead shape	Gullwing
	Lead bend direction	Normal bend
	Sealing method	Plastic mold
	Mounting height	2.65 mm Max

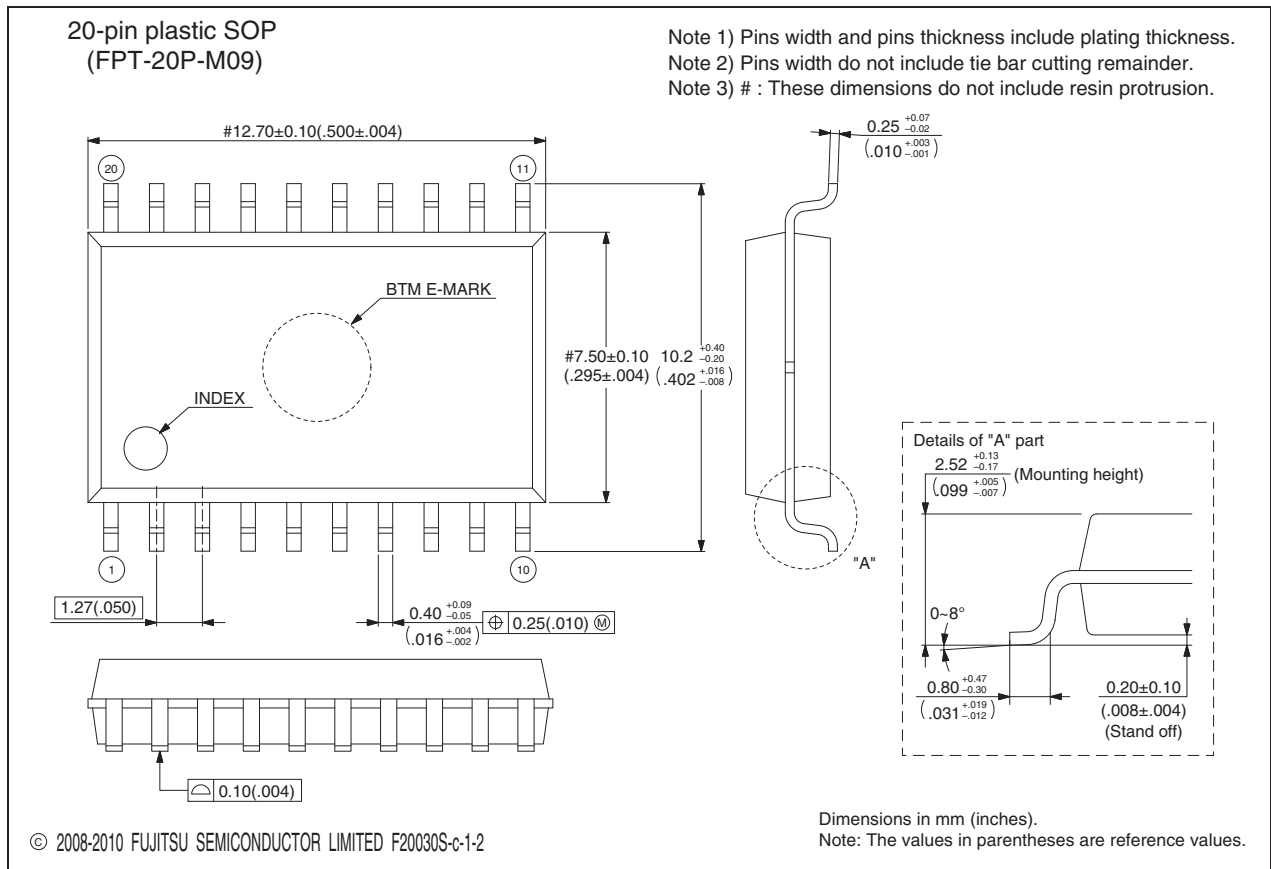

(Continued)

<p>20-pin plastic TSSOP</p> <p>(FPT-20P-M10)</p>	Lead pitch	0.65 mm
	Package width × package length	4.40 mm × 6.50 mm
	Lead shape	Gullwing
	Sealing method	Plastic mold
	Mounting height	1.20 mm MAX
	Weight	0.08 g

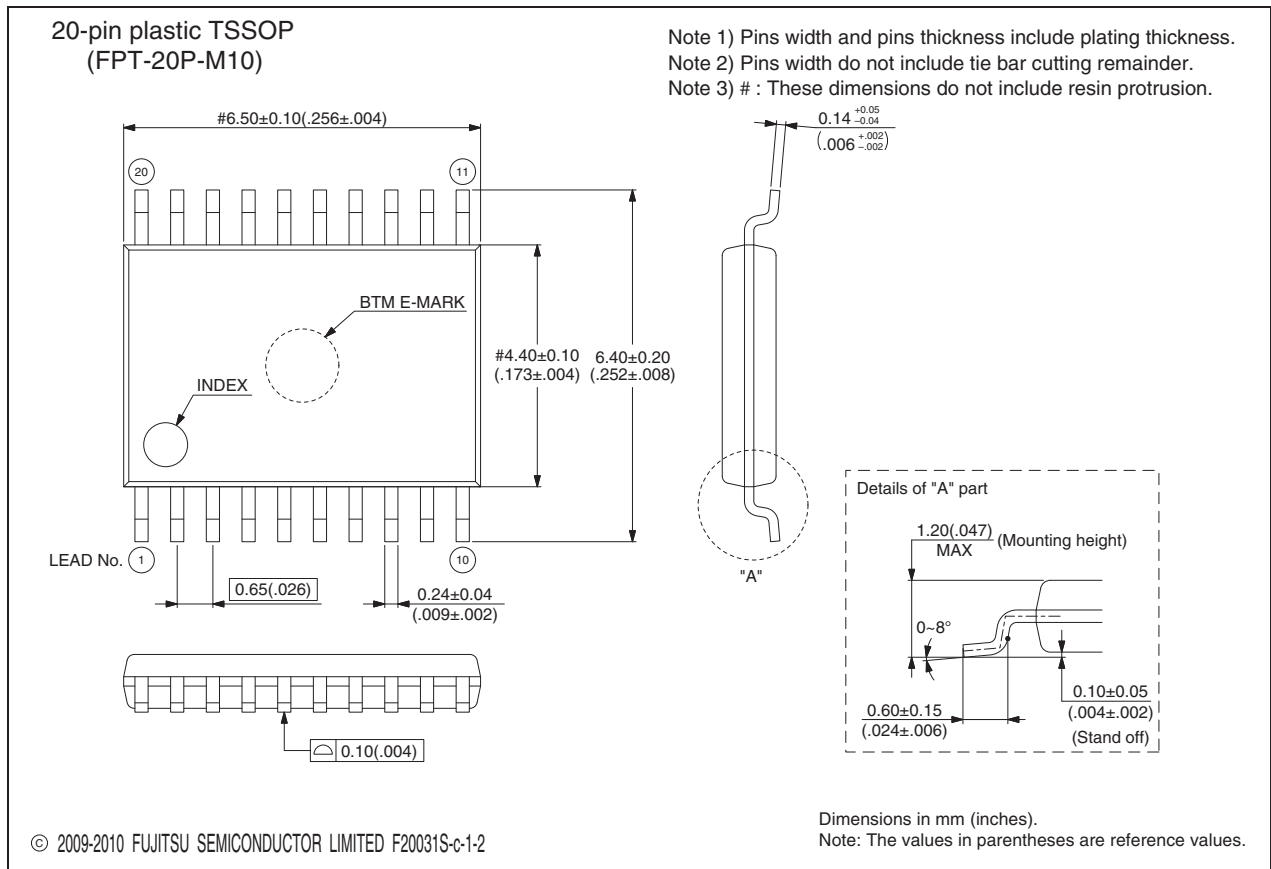

(Continued)

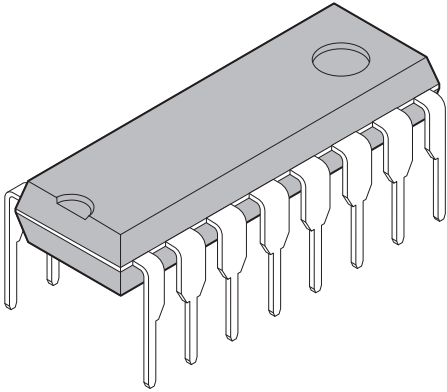
<p style="text-align: center;">16-pin plastic DIP</p>  <p style="text-align: center;">(DIP-16P-M06)</p>	Lead pitch	2.54 mm
	Sealing method	Plastic mold

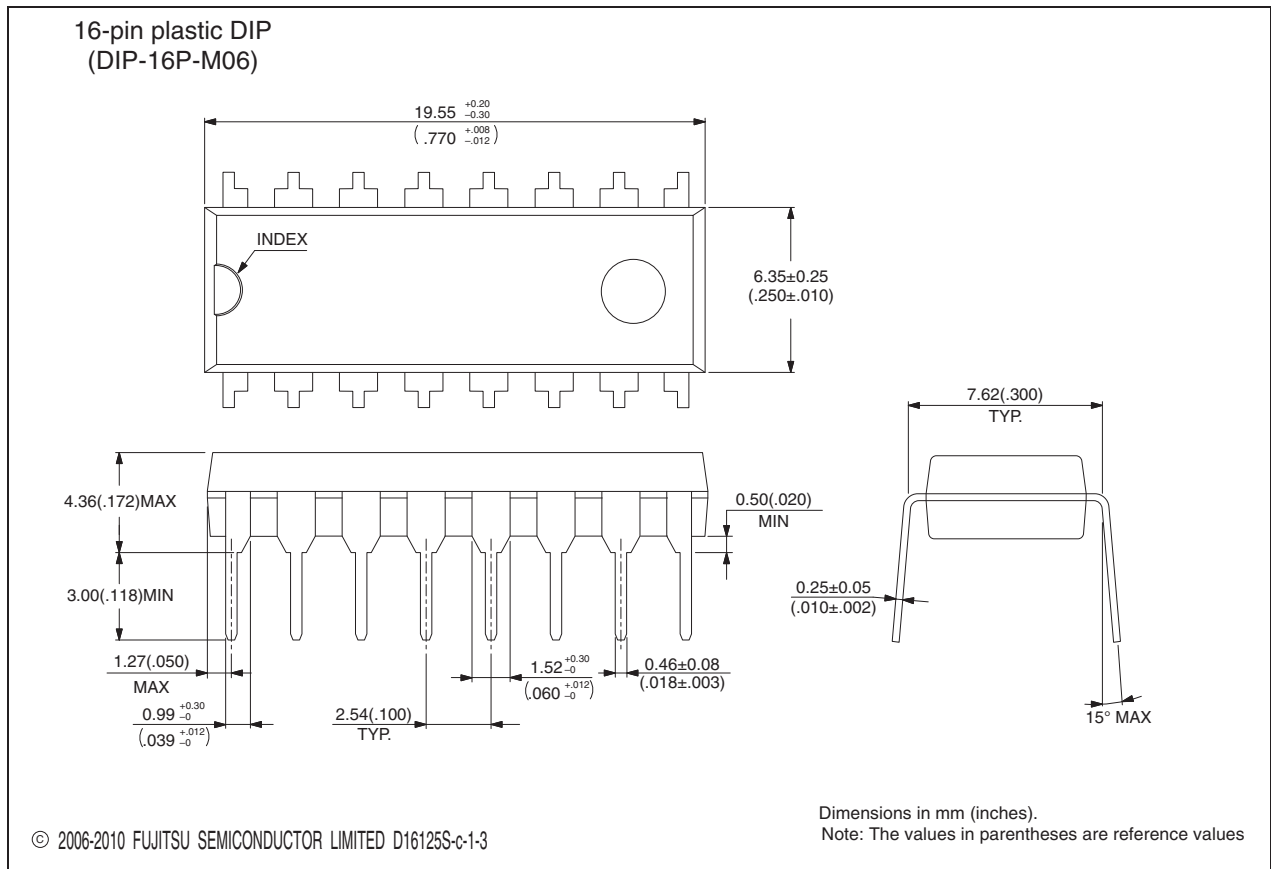

(Continued)

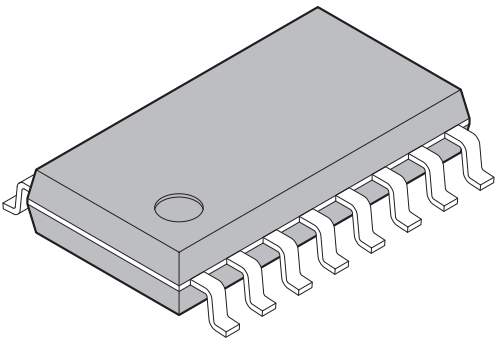
<p style="text-align: center;">16-pin plastic SOP</p>  <p style="text-align: center;">(FPT-16P-M06)</p>	Lead pitch	1.27 mm
	Package width × package length	5.3 × 10.15 mm
	Lead shape	Gullwing
	Sealing method	Plastic mold
	Mounting height	2.25 mm MAX
	Weight	0.20 g
	Code (Reference)	P-SOP16-5.3×10.15-1.27

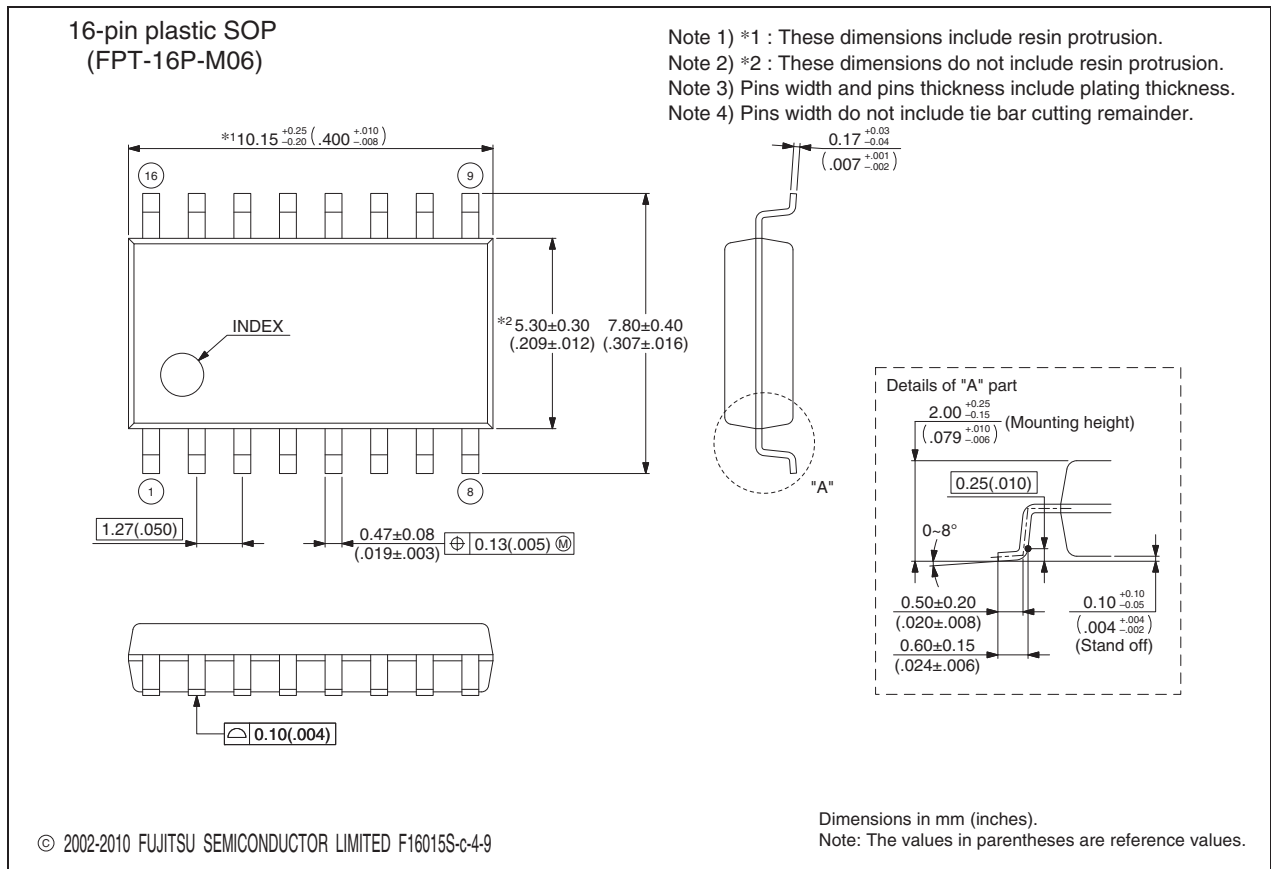

(Continued)

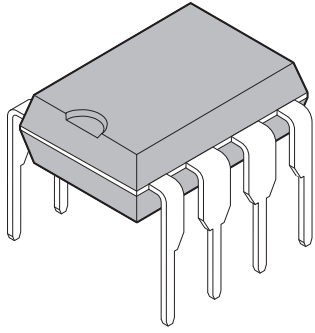
<p>8-pin plastic DIP</p>  <p>(DIP-8P-M03)</p>	Lead pitch	2.54 mm
	Sealing method	Plastic mold

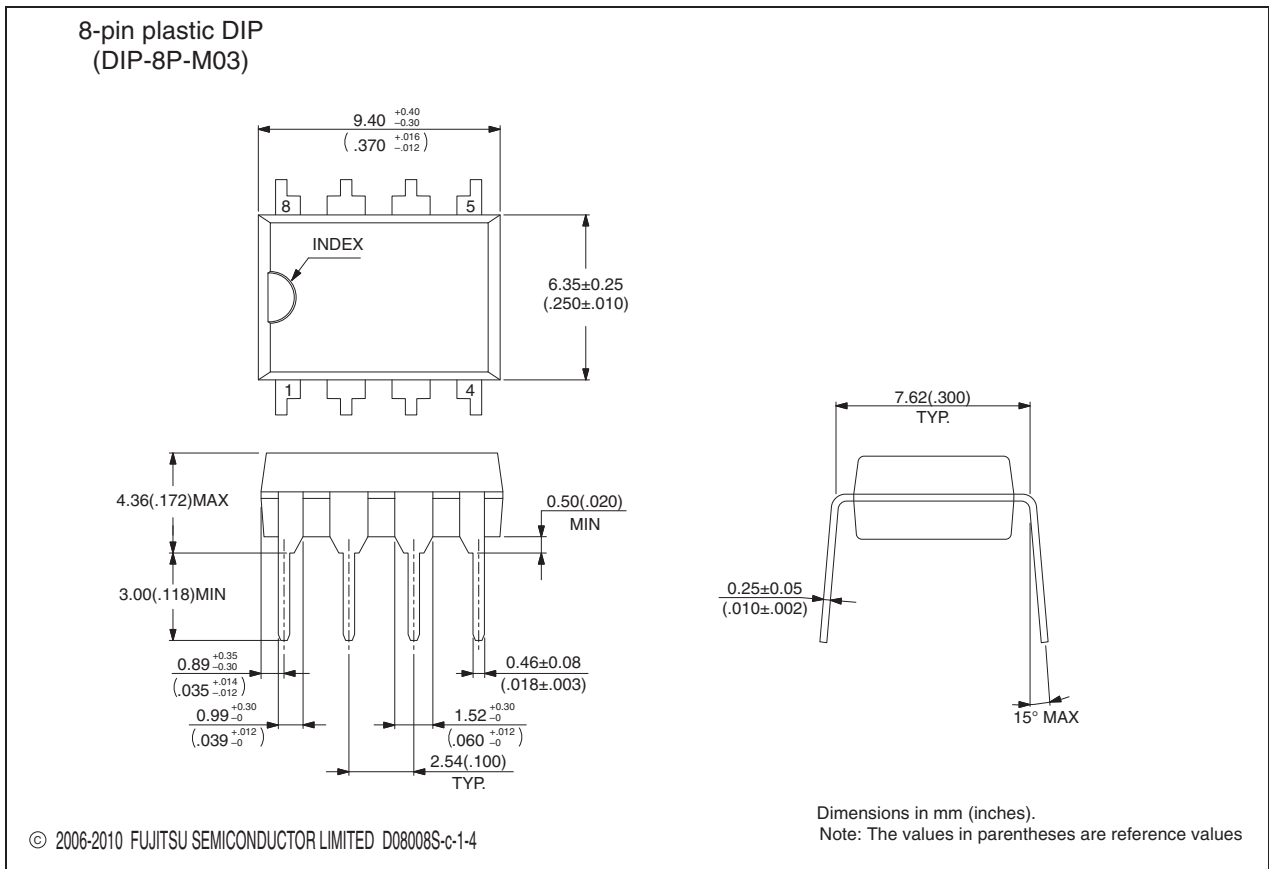

(Continued)

(Continued)

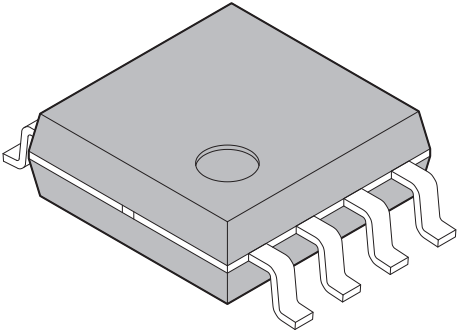
<p style="text-align: center;">8-pin plastic SOP</p>  <p style="text-align: center;">(FPT-8P-M08)</p>	Lead pitch	1.27 mm
	Package width × package length	5.30 mm × 5.24 mm
	Lead shape	Gullwing
	Lead bend direction	Normal bend
	Sealing method	Plastic mold
	Mounting height	2.10 mm Max

8-pin plastic SOP
(FPT-8P-M08)

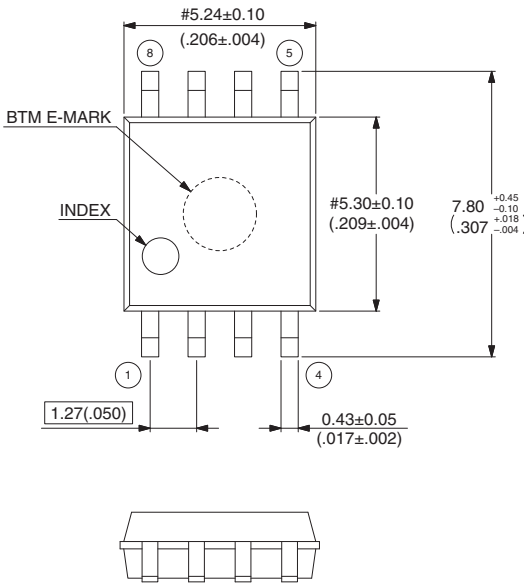

BTM E-MARK

INDEX

#5.24±0.10
(.206±.004)

#5.30±0.10
(.209±.004)

7.80^{+0.45}_{-0.10}
(.307^{+0.018}_{-.004})

1.27(.050)

0.43±0.05
(.017±.002)

Note 1) Pins width and pins thickness include plating thickness.
Note 2) Pins width do not include tie bar cutting remainder.
Note 3) # : These dimensions do not include resin protrusion.

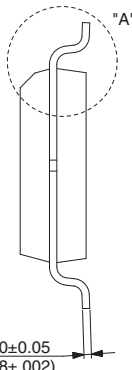

"A"

0.20±0.05
(.008±.002)

Details of "A" part

2.10(.083)
MAX
(Mounting height)

0-8°

0.10^{+0.15}_{-0.05}
(.004^{+0.006}_{-.002})
(Stand off)

0.75^{+0.10}_{-0.20}
(.030^{+0.004}_{-.008})

© 2008-2010 FUJITSU SEMICONDUCTOR LIMITED F08016S-c-1-2

Dimensions in mm (inches).
Note: The values in parentheses are reference values.

29. Major Changes

Spansion Publication Number: DS07–12627–7E

Page	Section	Details
1	—	Changed the family name. F ² MC-8FX → New 8FX
2	Features	Added “• Power-on reset”.
3	Product Line-up MB95260H Series	Added the parameter “Power-on reset”.
5	Product Line-up MB95270H Series	Added the parameter “Power-on reset”.
6	Product Line-up MB95280H Series	Added the parameter “Power-on reset”.
10	Pin Assignment	Deleted the HCLK1 pin and the HCLK2 pin.
11		Deleted the HCLK1 pin and the HCLK2 pin.
13	Pin Description (MB95260H Series, 32 pins)	Deleted the HCLK1 pin and the HCLK2 pin.
15	Pin Description (MB95260H Series, 24 pins)	Deleted the HCLK1 pin and the HCLK2 pin.
17	Pin Description (MB95260H Series, 20 pins)	Deleted the HCLK1 pin and the HCLK2 pin.
18	Pin Description (MB95270H Series, 8 pins)	Deleted the HCLK1 pin and the HCLK2 pin.
19	Pin Description (MB95280H Series, 32 pins)	Deleted the HCLK1 pin.
20		Deleted the HCLK2 pin.
21	Pin Description (MB95280H Series, 16 pins)	Deleted the HCLK1 pin.
22		Deleted the HCLK2 pin.
27	Block Diagram (MB95260H Series)	Deleted the HCLK1 pin and the HCLK2 pin.
28	Block Diagram (MB95270H Series)	Deleted the HCLK1 pin and the HCLK2 pin.
29	Block Diagram (MB95280H Series)	Deleted the HCLK1 pin and the HCLK2 pin.
52, 53	Electrical Characteristics 4. AC Characteristics (1) Clock Timing	Deleted all information about the HCLK1 pin and the HCLK2 pin in the table.
54		Deleted the HCLK1 pin and the HCLK2 pin in the “ Input waveform generated when an external clock (main clock) is used”. Deleted the external connection diagram for the HCLK1 pin and the HCLK2 pin in “ Figure of main clock input port external connection”.

NOTE: Please see “Document History” about later revised information.

Document History

Document Title: MB95260H/270H/280H Series New 8FX 8-bit Microcontrollers				
Document Number: 002-07516				
Revision	ECN	Orig. of Change	Submission Date	Description of Change
**	—	AKIH	07/04/2011	Migrated to Cypress and assigned document number 002-07516. No change to document contents or format.
*A	5199019	AKIH	04/04/2016	Updated to Cypress format.
*B	5861649	YSAT	08/24/2017	Adapted new Cypress logo

Sales, Solutions, and Legal Information

Worldwide Sales and Design Support

Cypress maintains a worldwide network of offices, solution centers, manufacturer's representatives, and distributors. To find the office closest to you, visit us at [Cypress Locations](#).

Products

ARM® Cortex® Microcontrollers	cypress.com/arm
Automotive	cypress.com/automotive
Clocks & Buffers	cypress.com/clocks
Interface	cypress.com/interface
Internet of Things	cypress.com/iot
Memory	cypress.com/memory
Microcontrollers	cypress.com/mcu
PSoC	cypress.com/psoc
Power Management ICs	cypress.com/pmic
Touch Sensing	cypress.com/touch
USB Controllers	cypress.com/usb
Wireless/RF	cypress.com/wireless

PSoC® Solutions

[PSoC 1](#) | [PSoC 3](#) | [PSoC 4](#) | [PSoC 5LP](#) | [PSoC 6](#)

Cypress Developer Community

[Forums](#) | [WICED IOT Forums](#) | [Projects](#) | [Video](#) | [Blogs](#) | [Training](#) | [Components](#)

Technical Support

cypress.com/support



© Cypress Semiconductor Corporation 2008-2017. This document is the property of Cypress Semiconductor Corporation and its subsidiaries, including Spansion LLC ("Cypress"). This document, including any software or firmware included or referenced in this document ("Software"), is owned by Cypress under the intellectual property laws and treaties of the United States and other countries worldwide. Cypress reserves all rights under such laws and treaties and does not, except as specifically stated in this paragraph, grant any license under its patents, copyrights, trademarks, or other intellectual property rights. If the Software is not accompanied by a license agreement and you do not otherwise have a written agreement with Cypress governing the use of the Software, then Cypress hereby grants you under its copyright rights in the Software, a personal, non-exclusive, nontransferable license (without the right to sublicense) (a) for Software provided in source code form, to modify and reproduce the Software solely for use with Cypress hardware products, only internally within your organization, and (b) to distribute the Software in binary code form externally to end users (either directly or indirectly through resellers and distributors), solely for use on Cypress hardware product units. Cypress also grants you a personal, non-exclusive, nontransferable, license (without the right to sublicense) under those claims of Cypress's patents that are infringed by the Software (as provided by Cypress, unmodified) to make, use, distribute, and import the Software solely to the minimum extent that is necessary for you to exercise your rights under the copyright license granted in the previous sentence. Any other use, reproduction, modification, translation, or compilation of the Software is prohibited.

TO THE EXTENT PERMITTED BY APPLICABLE LAW, CYPRESS MAKES NO WARRANTY OF ANY KIND, EXPRESS OR IMPLIED, WITH REGARD TO THIS DOCUMENT OR ANY SOFTWARE OR ACCOMPANYING HARDWARE, INCLUDING, BUT NOT LIMITED TO, THE IMPLIED WARRANTIES OF MERCHANTABILITY AND FITNESS FOR A PARTICULAR PURPOSE. To the extent permitted by applicable law, Cypress reserves the right to make changes to this document without further notice. Cypress does not assume any liability arising out of the application or use of any product or circuit described in this document. Any information provided in this document, including any sample design information or programming code, is provided only for reference purposes. It is the responsibility of the user of this document to properly design, program, and test the functionality and safety of any application made of this information and any resulting product. Cypress products are not designed, intended, or authorized for use as critical components in systems designed or intended for the operation of weapons, weapons systems, nuclear installations, life-support devices or systems, other medical devices or systems (including resuscitation equipment and surgical implants), pollution control or hazardous substances management, or other uses where the failure of the device or system could cause personal injury, death, or property damage ("Unintended Uses"). A critical component is any component of a device or system whose failure to perform can be reasonably expected to cause the failure of the device or system, or to affect its safety or effectiveness. Cypress is not liable, in whole or in part, and you shall and hereby do release Cypress from any claim, damage, or other liability arising from or related to all Unintended Uses of Cypress products. You shall indemnify and hold Cypress harmless from and against all claims, costs, damages, and other liabilities, including claims for personal injury or death, arising from or related to any Unintended Uses of Cypress products.

Cypress, the Cypress logo, Spansion, the Spansion logo, and combinations thereof, WICED, PSoC, CapSense, EZ-USB, F-RAM, and Traveo are trademarks or registered trademarks of Cypress in the United States and other countries. For a more complete list of Cypress trademarks, visit cypress.com. Other names and brands may be claimed as property of their respective owners.

Looking for pricing, stock, or lifecycle information?

Click below to explore more details on WIN SOURCE:

-  [View MB95F274KPF-G-SNE2 on WIN SOURCE](#)
-  [Cypress Semiconductor Corp Information](#)

Optimize Your Supply Chain with WIN SOURCE Solutions

-  Global Sourcing Solution
-  Obsolete Management
-  Cost Control Management
-  Shortage Management
-  Alternative Solution
-  Excess Inventory Management