

400mA PCI LDO

Features:

- Glitch Free Transition Between Input Sources
- Automatic Input Source Selection
- External PMOS Bypass Switch Control
- Built-in 5V Detector
- 1% Regulated Output Voltage Accuracy
- 400mA Load Current Capability
- Kelvin Sense Input
- Low Ground Current, Independent of Load

Applications:

- PCMCIA
- PCI
- Network Interface Cards (NICs)
- Cardbus™ Technology
- Desktop Computers

Device Selection Table

Part Number	Package	Junction Temp. Range
TC1267VET	5-Pin DDPACK	-5°C to +95°C

Pin Configuration

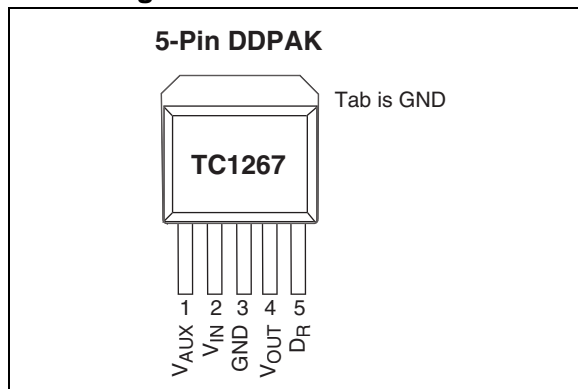

General Description:

The TC1267 is an application-specific, low dropout regulator (LDO), specifically intended for use in PCI peripheral card applications complying with PCI Power Management (PCI 2.0). It provides an uninterrupted, 3.3V output voltage when the main (5V) or auxiliary (3.3V) input voltage supplies are present.

The TC1267 consists of an LDO, a voltage threshold detector, external switchover logic and gate drive circuitry. It functions as a conventional LDO as long as the voltage on the main supply input (V_{IN}) is above the lower threshold (3.90V typical). Should the voltage on V_{IN} fall below the lower threshold, the LDO is disabled and an external P-channel MOSFET is automatically turned on, connecting the auxiliary supply input to V_{OUT} , and ensuring an uninterrupted 3.3V output. The main supply is automatically selected, if both the main and auxiliary input supplies are present, and transition from one input supply to the other is ensured glitch-free. High integration, automatic secondary supply switchover, Kelvin sensing, and small size make the TC1267 the optimum LDO for PCI 2.0 applications.

Functional Block Diagram

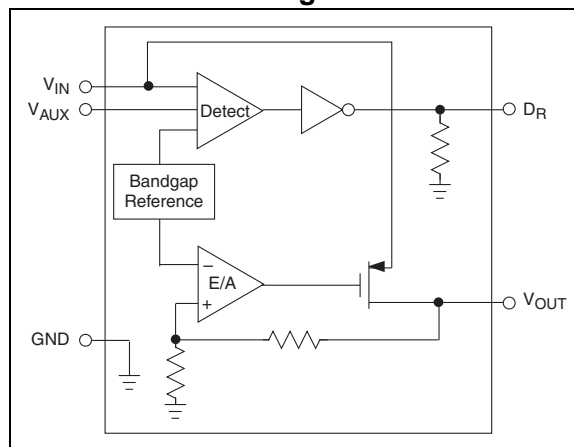

TC1267

1.0 ELECTRICAL CHARACTERISTICS

Absolute Maximum Ratings*

Input Supply Voltage (V_{IN}).....-0.5V to +7V (Max)
 Auxiliary Supply Voltage (V_{AUX})-0.5V to +7V (Max)
 LDO Output Current (I_{OUT}).....400mA
 Thermal Impedance,
 Junction-to-Ambient (θ_{JA})..... 27°C/W for DDPAK
 ESD Rating 2 KV
 Operating Temperature Range (T_A).....-5°C to +70°C
 Storage Temperature Range (T_{STG})...-65°C to +150°C

*Stresses above those listed under "Absolute Maximum Ratings" may cause permanent damage to the device. These are stress ratings only and functional operation of the device at these or any other conditions above those indicated in the operation sections of the specifications is not implied. Exposure to Absolute Maximum Rating conditions for extended periods may affect device reliability.

TC1267 ELECTRICAL SPECIFICATIONS

Electrical Characteristics: $T_A = +25^\circ\text{C}$, $V_{IN} = 5\text{V}$, $V_{AUX} = 3.3\text{V}$, $I_{OUT} = 0.1\text{mA}$, $C_{OUT} = 4.7\mu\text{F}$, unless otherwise noted. **Boldface** type specifications apply over full operating range.

Symbol	Parameter	Min.	Typ.	Max.	Units	Test Conditions
V_{IN}	Supply Voltage	4.4	5.0	5.5	V	$V_{AUX} = 0\text{V}$
I_{GND}	Ground Current	—	230	450	μA	$V_{AUX} = 0\text{V}$ (Note 6) $V_{AUX} = 3.3\text{V}$ (Note 6)
I_{VIN}	Reverse Leakage from V_{AUX}	—	-0.1	-1.0	μA	$V_{AUX} = 3.5\text{V}$, $V_{IN} = 0\text{V}$, $I_{OUT} = 0\text{mA}$
V_{AUX}	Supply Voltage	3.0	3.3	3.6	V	
$I_{Q(AUX)}$	Quiescent Current	—	50	70	μA	$V_{IN} = 0\text{V}$, $I_{OUT} = 0\text{mA}$
		—	—	100		
		—	60	80	μA	$V_{IN} = 5\text{V}$, $I_{OUT} = 0\text{mA}$
		—	—	120		
I_{VAUX}	Reverse Leakage from V_{IN}	—	-0.1	-1.0	μA	$V_{IN} = 5.5\text{V}$, $V_{AUX} = 0\text{V}$, $I_{OUT} = 0\text{mA}$
$V_{TH(LO)}$	5V Detector Low Threshold Voltage	—	3.90	—	V	V_{IN} Falling (Notes 2, 3)
		3.75	—	4.05		
V_{HYST}	5V Detector Hysteresis Voltage	—	260	—	mV	(Notes 2, 3)
		200	—	300		
$V_{TH(HI)}$	5V Detector High Threshold Voltage	—	4.15	—	V	V_{IN} Rising (Notes 2, 3)
		4.0	—	4.30		
V_{OUT}	LDO Output Voltage	—	3.300	—	V	$I_{OUT} = 20\text{mA}$
		3.201	—	3.366	V	$4.4\text{V} \leq V_{IN} \leq 5.5\text{V}$, $0\text{mA} \leq I_{OUT} \leq 400\text{mA}$
		3.000	—	—	V	$0\text{mA} \leq I_{OUT} \leq 400\text{mA}$ (Note 4)
I_{OUT}	Output Current	400	—	—	mA	
$REG_{(LINE)}$	Line Regulation	—	0.05	—	%	$V_{IN} = 4.3\text{V}$ to 5.5V
		-0.5	—	+0.5		
$REG_{(LOAD)}$	Load Regulation	—	-0.1	—	%	$I_{OUT} = 0.1\text{mA}$ to 400mA
		-1.5	—	+0.5		
V_{DR}	Drive Voltage	$V_{IN} - 0.2$	$V_{IN} - 0.1$	—	V	$4.3\text{V} \leq V_{IN} \leq 5.5\text{V}$, $I_{DR} = 200\mu\text{A}$
		$V_{IN} - 0.3$	—	—		
		—	35	150	mV	$V_{IN} < V_{TH(LO)}$, $I_{DR} = 200\mu\text{A}$
		—	—	200		

- Note**
- 1: Ensured by design.
 - 2: See 5V Detect Thresholds, Figure 4-1.
 - 3: Recommended source impedance for 5V supply: $\leq 0.25\Omega$. This will ensure that $I_{OUT} \times R_{SOURCE} < V_{HYST}$, thus avoiding D_R toggling during 5V detect threshold transitions.
 - 4: In Application Circuit, Figure 3-1.
 - 5: See Timing Diagram, Figure 4-2.
 - 6: Ground Current is independent of I_{LOAD} .

TC1267 ELECTRICAL SPECIFICATIONS (CONTINUED)

Electrical Characteristics: $T_A = +25^\circ\text{C}$, $V_{IN} = 5\text{V}$, $V_{AUX} = 3.3\text{V}$, $I_{OUT} = 0.1\text{mA}$, $C_{OUT} = 4.7\mu\text{F}$, unless otherwise noted. **Boldface** type specifications apply over full operating range.

Symbol	Parameter	Min.	Typ.	Max.	Units	Test Conditions
$I_{DR(PK)}$	Peak Drive Current	7 6	—	—	mA	Sinking: $V_{IN} = 3.75\text{V}$, $V_{DR} = 1\text{V}$; Sourcing: $V_{IN} = 4.3\text{V}$, $V_{IN} - V_{OR} = 2\text{V}$
t_{DH}	Drive High Delay (Notes 1, 5)	—	4	—	μsec	$C_{DR} = 1.2\text{nF}$, V_{IN} ramping up, measured from $V_{IN} = V_{TH(HI)}$ to $V_{DR} = 2\text{V}$
t_{DL}	Drive Low Delay (Notes 1, 5)	—	0.6	1.5	μsec	$C_{DR} = 1.2\text{nF}$, V_{IN} ramping down, measured from $V_{IN} = V_{TH(LO)}$ to $V_{DR} = 2\text{V}$

- Note**
- 1: Ensured by design.
 - 2: See 5V Detect Thresholds, Figure 4-1.
 - 3: Recommended source impedance for 5V supply: $\leq 0.25\Omega$. This will ensure that $I_{OUT} \times R_{SOURCE} < V_{HYST}$, thus avoiding D_R toggling during 5V detect threshold transitions.
 - 4: In Application Circuit, Figure 3-1.
 - 5: See Timing Diagram, Figure 4-2.
 - 6: Ground Current is independent of I_{LOAD} .

TC1267

2.0 PIN DESCRIPTIONS

The descriptions of the pins are listed in Table 2-1.

TABLE 2-1: PIN FUNCTION TABLE

Pin No.	Symbol	Description
1	V _{AUX}	Auxiliary input supply, nominally 3.3V.
2	V _{IN}	Main input supply for the TC1267, nominally 5V.
3	GND	Logic and power ground.
4	V _{OUT}	LDO 3.3V output.
5	D _R	Driver output for external P-channel MOSFET pass element.

3.0 DETAILED DESCRIPTION

FIGURE 3-1: APPLICATION CIRCUIT

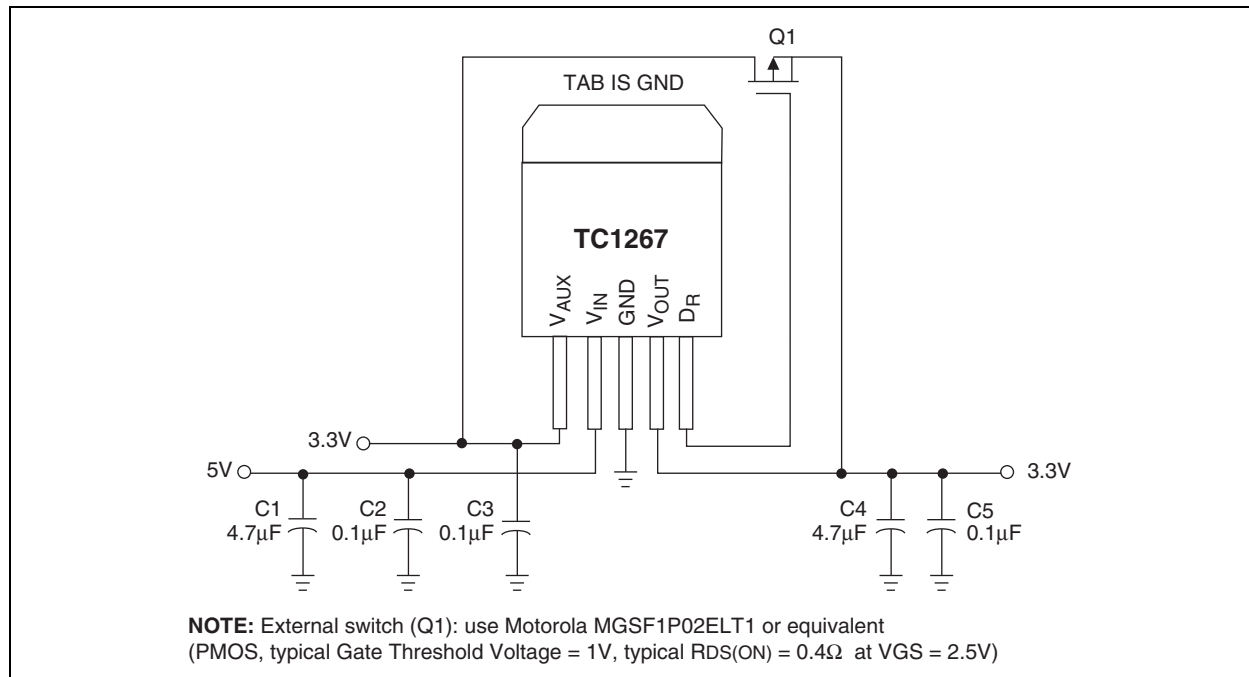

4.0 THERMAL CONSIDERATIONS

4.1 Thermal Shutdown

Integrated thermal protection circuitry shuts the regulator off when die temperature exceeds 160°C. The regulator remains off until the die temperature drops to approximately 150°C.

4.2 Power Dissipation

The amount of power the regulator dissipates is primarily a function of input and output voltage, and output current. The following equation is used to calculate worst case actual power dissipation:

EQUATION 4-1:

$$P_D \approx (V_{INMAX} - V_{OUTMIN})I_{LOADMAX}$$

Where:

- P_D = Worst case actual power dissipation
- V_{INMAX} = Maximum voltage on V_{IN}
- V_{OUTMIN} = Minimum regulator output voltage
- $I_{LOADMAX}$ = Maximum output (load) current

The maximum allowable power dissipation (Equation 4-2) is a function of the maximum ambient temperature (T_{AMAX}), the maximum allowable die temperature (T_{JMAX}) and the thermal resistance from junction-to-air (θ_{JA}).

EQUATION 4-2:

$$P_{DMAX} = \frac{(T_{JMAX} - T_{AMAX})}{\theta_{JA}}$$

Where all terms are previously defined.

Table 4-1 shows various values of θ_{JA} for the TC1267 packages.

TABLE 4-1: THERMAL RESISTANCE GUIDELINES FOR TC1267 IN 5-PIN DDPAK

Copper Area (Topside)*	Copper Area (Backside)	Board Area	Thermal Resistance (θ_{JA})
2500 sq mm	2500 sq mm	2500 sq mm	25°C/W
1000 sq mm	2500 sq mm	2500 sq mm	27°C/W
125 sq mm	2500 sq mm	2500 sq mm	35°C/W

*Tab of device attached to topside copper.

Equation 4-1 can be used in conjunction with Equation 4-2 to ensure regulator thermal operation is within limits. For example:

Given:

$$\begin{aligned} V_{INMAX} &= 5V \pm 5\% \\ V_{OUTMIN} &= 3.217V \\ I_{LOADMAX} &= 400mA \\ T_{JMAX} &= 95^\circ C \\ T_{AMAX} &= 70^\circ C \\ \theta_{JA} &= 27^\circ C/W \text{ (DDPAK mounted on} \\ &\quad \text{1000 sq mm topside copper area)} \end{aligned}$$

- Find: 1. Actual power dissipation
2. Maximum allowable dissipation

Actual power dissipation:

$$\begin{aligned} P_D &\approx (V_{INMAX} - V_{OUTMIN})I_{LOADMAX} \\ &= (5.25V - 3.217V) 400mA \\ &= 813mW \end{aligned}$$

Maximum allowable power dissipation:

$$\begin{aligned} P_{DMAX} &= \frac{(T_{JMAX} - T_{AMAX})}{\theta_{JA}} \\ &= \frac{(95 - 70)}{27} \\ &= 423mW \end{aligned}$$

In this example, the TC1267 dissipates a maximum of 813mW; below the allowable limit of 926mW.

TC1267

FIGURE 4-1: 5V DETECT THRESHOLD

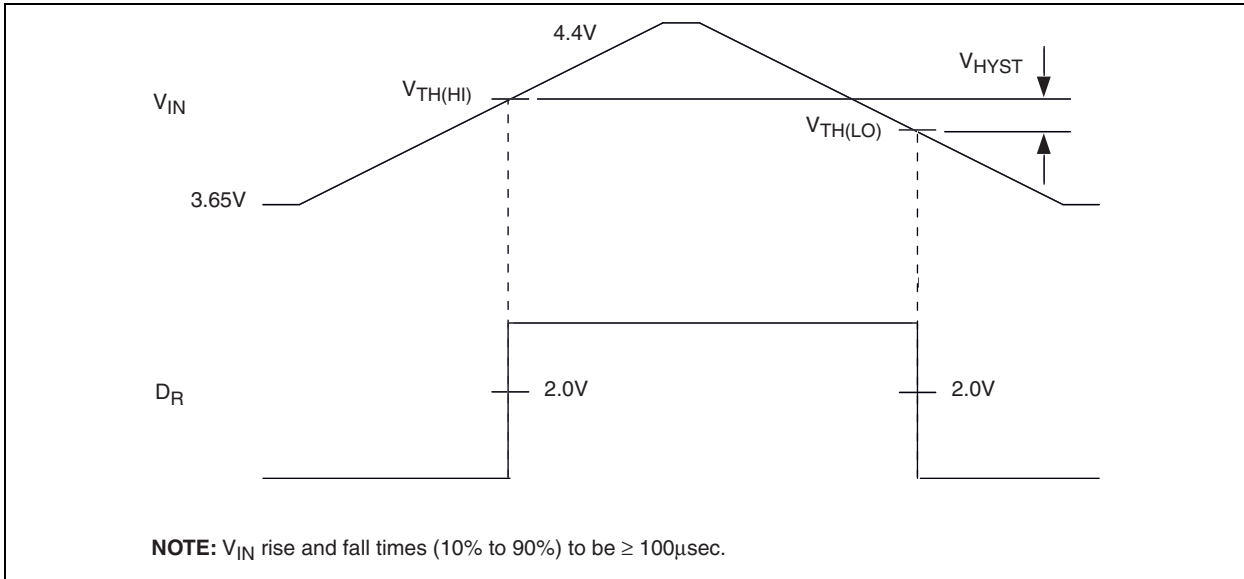
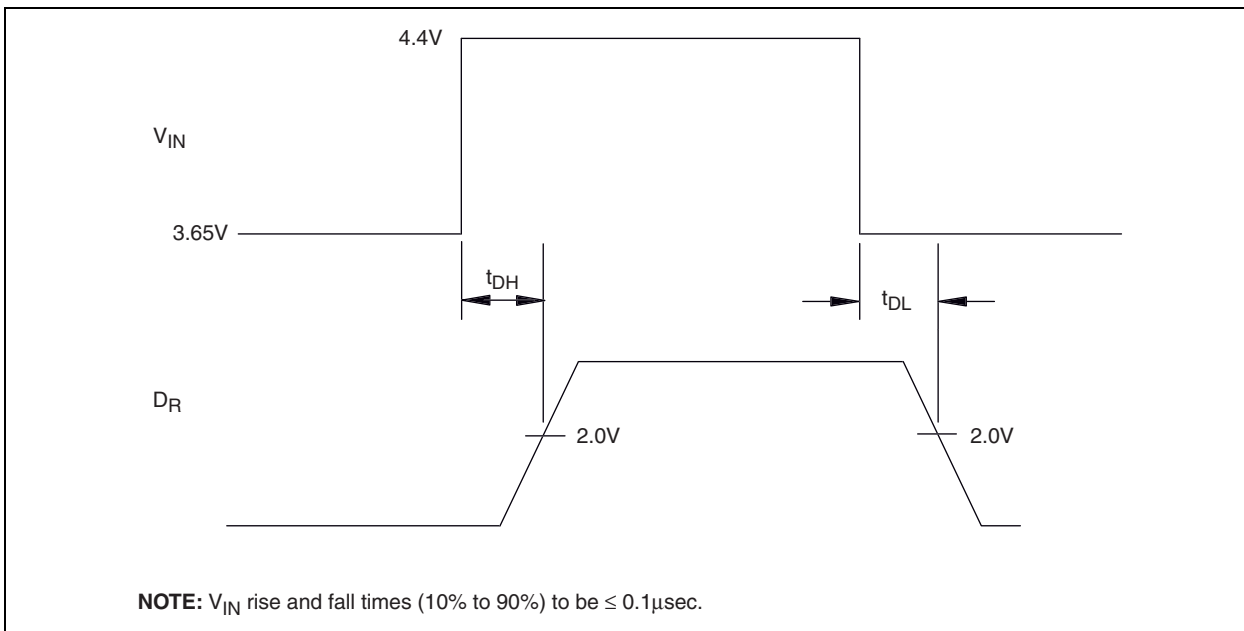
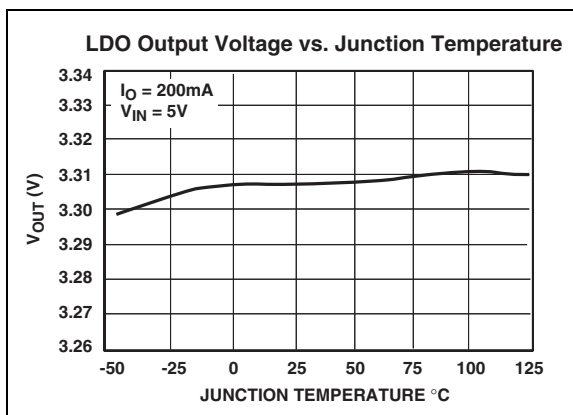
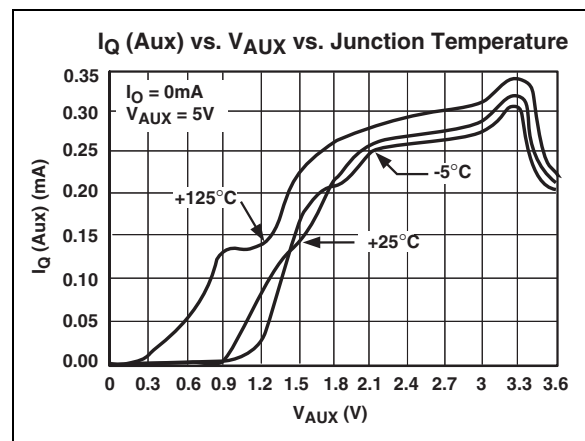
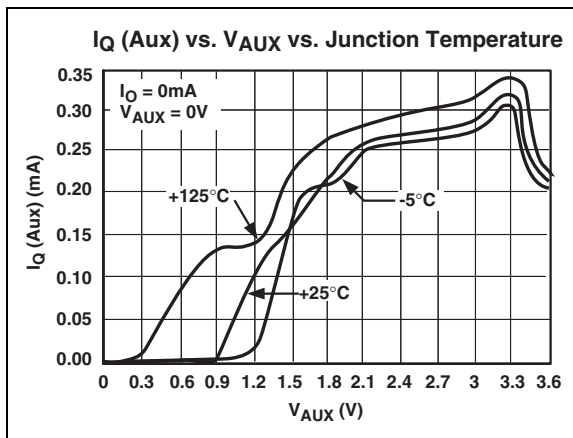
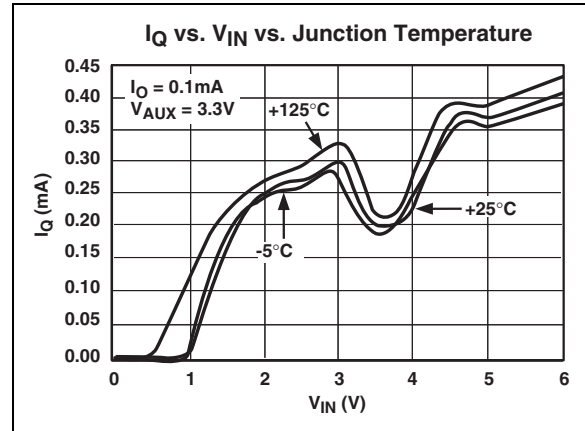
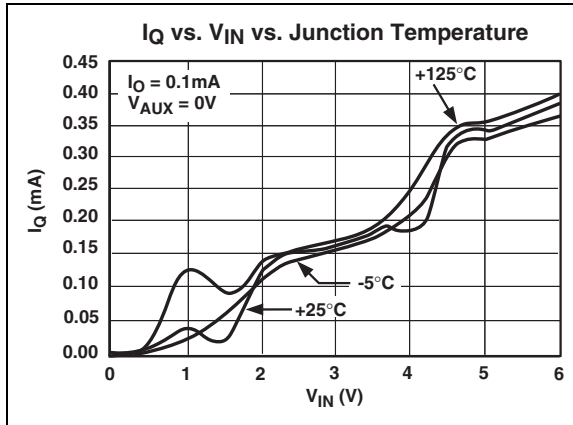

FIGURE 4-2: TIMING DIAGRAM



5.0 TYPICAL CHARACTERISTICS

Note: The graphs and tables provided following this note are a statistical summary based on a limited number of samples and are provided for informational purposes only. The performance characteristics listed herein are not tested or guaranteed. In some graphs or tables, the data presented may be outside the specified operating range (e.g., outside specified power supply range) and therefore outside the warranted range.



5.0 TYPICAL CHARACTERISTICS (CONTINUED)

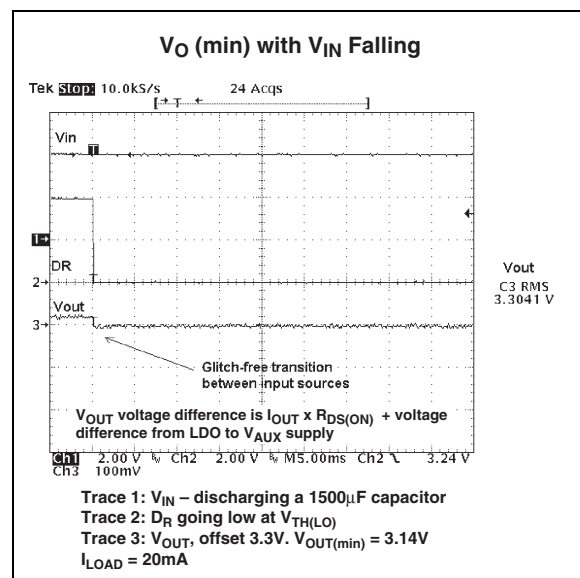
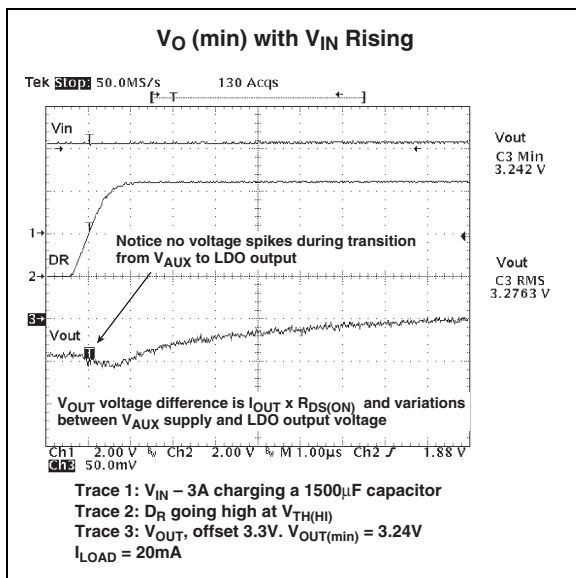
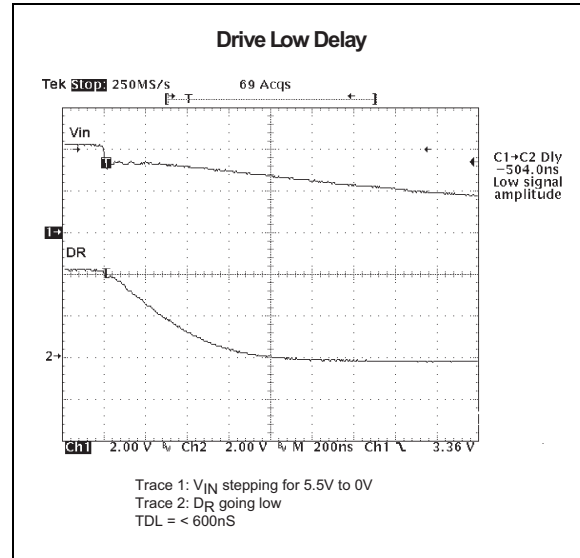
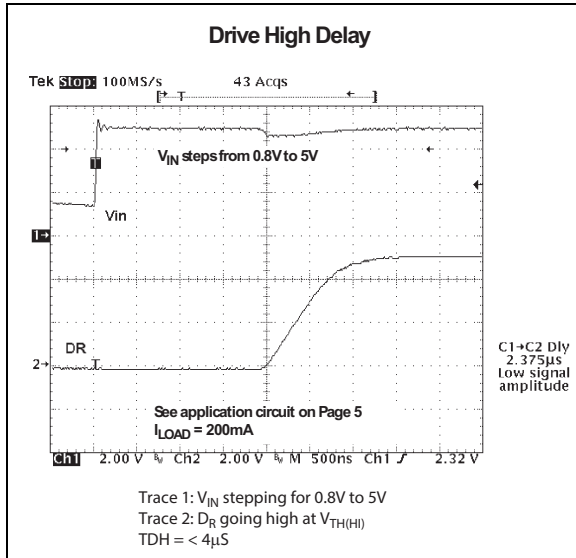

6.0 PACKAGING INFORMATION

6.1 Package Marking Information

Package marking data not available at this time.

6.2 Taping Form

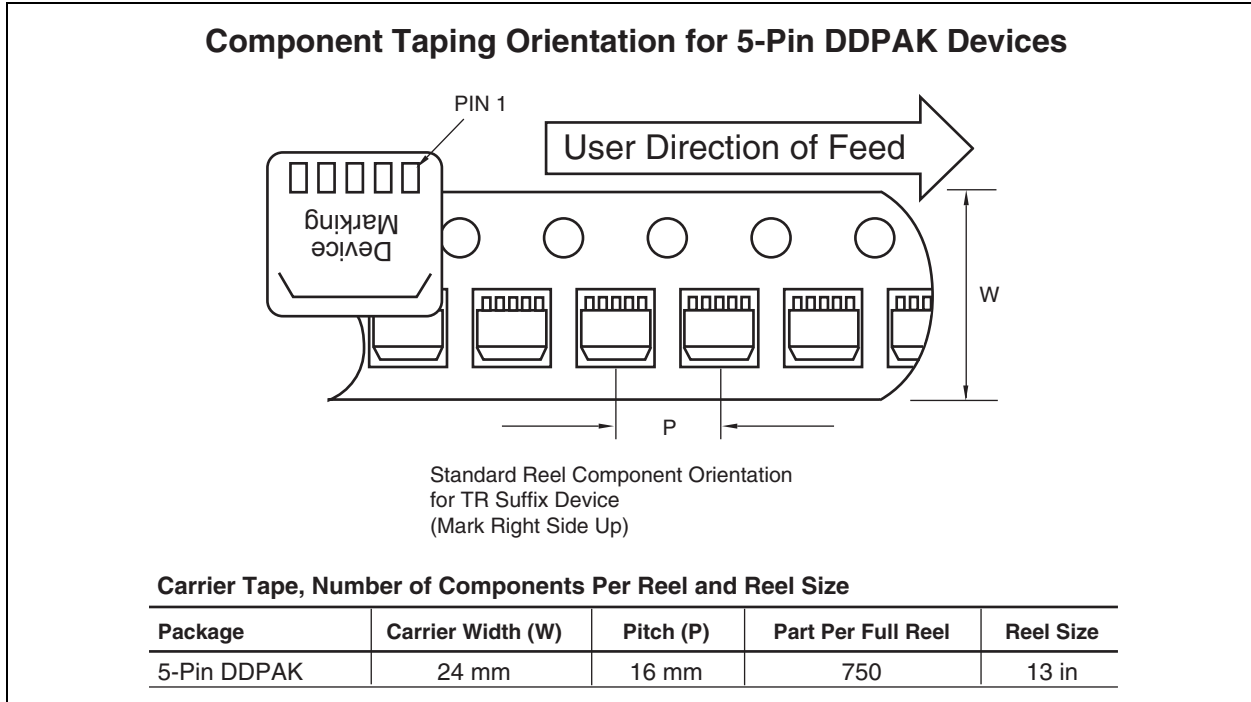

6.3 Package Dimensions

Note: For the most current package drawings, please see the Microchip Packaging Specification located at <http://www.microchip.com/packaging>

5-Pin DDPAK

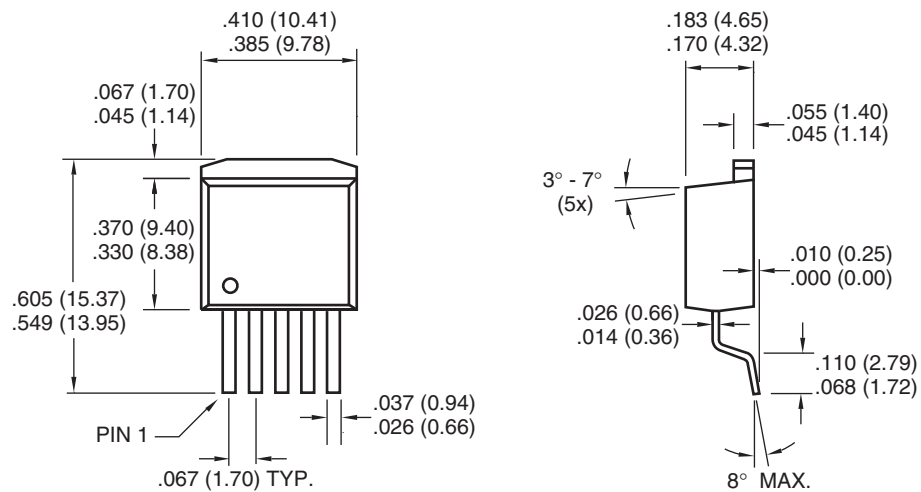

7.0 REVISION HISTORY

Revision C (November 2012)

Added a note to each package outline drawing.

Revision D (December 2014)

Added "Obsolete" note box to header.

THE MICROCHIP WEB SITE

Microchip provides online support via our WWW site at www.microchip.com. This web site is used as a means to make files and information easily available to customers. Accessible by using your favorite Internet browser, the web site contains the following information:

- **Product Support** – Data sheets and errata, application notes and sample programs, design resources, user's guides and hardware support documents, latest software releases and archived software
- **General Technical Support** – Frequently Asked Questions (FAQ), technical support requests, online discussion groups, Microchip consultant program member listing
- **Business of Microchip** – Product selector and ordering guides, latest Microchip press releases, listing of seminars and events, listings of Microchip sales offices, distributors and factory representatives

CUSTOMER CHANGE NOTIFICATION SERVICE

Microchip's customer notification service helps keep customers current on Microchip products. Subscribers will receive e-mail notification whenever there are changes, updates, revisions or errata related to a specified product family or development tool of interest.

To register, access the Microchip web site at www.microchip.com. Under "Support", click on "Customer Change Notification" and follow the registration instructions.

CUSTOMER SUPPORT

Users of Microchip products can receive assistance through several channels:

- Distributor or Representative
- Local Sales Office
- Field Application Engineer (FAE)
- Technical Support

Customers should contact their distributor, representative or Field Application Engineer (FAE) for support. Local sales offices are also available to help customers. A listing of sales offices and locations is included in the back of this document.

Technical support is available through the web site at: <http://microchip.com/support>

TC1267

NOTES:

Note the following details of the code protection feature on Microchip devices:

- Microchip products meet the specification contained in their particular Microchip Data Sheet.
- Microchip believes that its family of products is one of the most secure families of its kind on the market today, when used in the intended manner and under normal conditions.
- There are dishonest and possibly illegal methods used to breach the code protection feature. All of these methods, to our knowledge, require using the Microchip products in a manner outside the operating specifications contained in Microchip's Data Sheets. Most likely, the person doing so is engaged in theft of intellectual property.
- Microchip is willing to work with the customer who is concerned about the integrity of their code.
- Neither Microchip nor any other semiconductor manufacturer can guarantee the security of their code. Code protection does not mean that we are guaranteeing the product as “unbreakable.”

Code protection is constantly evolving. We at Microchip are committed to continuously improving the code protection features of our products. Attempts to break Microchip's code protection feature may be a violation of the Digital Millennium Copyright Act. If such acts allow unauthorized access to your software or other copyrighted work, you may have a right to sue for relief under that Act.

Information contained in this publication regarding device applications and the like is provided only for your convenience and may be superseded by updates. It is your responsibility to ensure that your application meets with your specifications. MICROCHIP MAKES NO REPRESENTATIONS OR WARRANTIES OF ANY KIND WHETHER EXPRESS OR IMPLIED, WRITTEN OR ORAL, STATUTORY OR OTHERWISE, RELATED TO THE INFORMATION, INCLUDING BUT NOT LIMITED TO ITS CONDITION, QUALITY, PERFORMANCE, MERCHANTABILITY OR FITNESS FOR PURPOSE. Microchip disclaims all liability arising from this information and its use. Use of Microchip devices in life support and/or safety applications is entirely at the buyer's risk, and the buyer agrees to defend, indemnify and hold harmless Microchip from any and all damages, claims, suits, or expenses resulting from such use. No licenses are conveyed, implicitly or otherwise, under any Microchip intellectual property rights.

Trademarks

The Microchip name and logo, the Microchip logo, dsPIC, FlashFlex, flexPWR, JukeBlox, KEELOQ, KEELOQ logo, Klear, LANCheck, MediaLB, MOST, MOST logo, MPLAB, OptoLyzer, PIC, PICSTART, PIC³² logo, RightTouch, SpyNIC, SST, SST Logo, SuperFlash and UNI/O are registered trademarks of Microchip Technology Incorporated in the U.S.A. and other countries.

The Embedded Control Solutions Company and mTouch are registered trademarks of Microchip Technology Incorporated in the U.S.A.

Analog-for-the-Digital Age, BodyCom, chipKIT, chipKIT logo, CodeGuard, dsPICDEM, dsPICDEM.net, ECAN, In-Circuit Serial Programming, ICSP, Inter-Chip Connectivity, KlearNet, KlearNet logo, MiWi, MPASM, MPF, MPLAB Certified logo, MPLIB, MPLINK, MultiTRAK, NetDetach, Omniscient Code Generation, PICDEM, PICDEM.net, PICkit, PICtail, RightTouch logo, REAL ICE, SQI, Serial Quad I/O, Total Endurance, TSHARC, USBCheck, VariSense, ViewSpan, WiperLock, Wireless DNA, and ZENA are trademarks of Microchip Technology Incorporated in the U.S.A. and other countries.

SQTP is a service mark of Microchip Technology Incorporated in the U.S.A.

Silicon Storage Technology is a registered trademark of Microchip Technology Inc. in other countries.

GestIC is a registered trademarks of Microchip Technology Germany II GmbH & Co. KG, a subsidiary of Microchip Technology Inc., in other countries.

All other trademarks mentioned herein are property of their respective companies.

© 2001-2014, Microchip Technology Incorporated, Printed in the U.S.A., All Rights Reserved.

ISBN: 978-1-63276-850-6

QUALITY MANAGEMENT SYSTEM
CERTIFIED BY DNV
== ISO/TS 16949 ==

Microchip received ISO/TS-16949:2009 certification for its worldwide headquarters, design and wafer fabrication facilities in Chandler and Tempe, Arizona; Gresham, Oregon and design centers in California and India. The Company's quality system processes and procedures are for its PIC® MCUs and dsPIC® DSCs, KEELOQ® code hopping devices, Serial EEPROMs, microperipherals, nonvolatile memory and analog products. In addition, Microchip's quality system for the design and manufacture of development systems is ISO 9001:2000 certified.



MICROCHIP

Worldwide Sales and Service

AMERICAS

Corporate Office
2355 West Chandler Blvd.
Chandler, AZ 85224-6199
Tel: 480-792-7200
Fax: 480-792-7277
Technical Support:
<http://www.microchip.com/support>
Web Address:
www.microchip.com

Atlanta
Duluth, GA
Tel: 678-957-9614
Fax: 678-957-1455

Austin, TX
Tel: 512-257-3370

Boston
Westborough, MA
Tel: 774-760-0087
Fax: 774-760-0088

Chicago
Itasca, IL
Tel: 630-285-0071
Fax: 630-285-0075

Cleveland
Independence, OH
Tel: 216-447-0464
Fax: 216-447-0643

Dallas
Addison, TX
Tel: 972-818-7423
Fax: 972-818-2924

Detroit
Novi, MI
Tel: 248-848-4000

Houston, TX
Tel: 281-894-5983

Indianapolis
Noblesville, IN
Tel: 317-773-8323
Fax: 317-773-5453

Los Angeles
Mission Viejo, CA
Tel: 949-462-9523
Fax: 949-462-9608

New York, NY
Tel: 631-435-6000

San Jose, CA
Tel: 408-735-9110

Canada - Toronto
Tel: 905-673-0699
Fax: 905-673-6509

ASIA/PACIFIC

Asia Pacific Office
Suites 3707-14, 37th Floor
Tower 6, The Gateway
Harbour City, Kowloon
Hong Kong
Tel: 852-2943-5100
Fax: 852-2401-3431

Australia - Sydney
Tel: 61-2-9868-6733
Fax: 61-2-9868-6755

China - Beijing
Tel: 86-10-8569-7000
Fax: 86-10-8528-2104

China - Chengdu
Tel: 86-28-8665-5511
Fax: 86-28-8665-7889

China - Chongqing
Tel: 86-23-8980-9588
Fax: 86-23-8980-9500

China - Hangzhou
Tel: 86-571-8792-8115
Fax: 86-571-8792-8116

China - Hong Kong SAR
Tel: 852-2943-5100
Fax: 852-2401-3431

China - Nanjing
Tel: 86-25-8473-2460
Fax: 86-25-8473-2470

China - Qingdao
Tel: 86-532-8502-7355
Fax: 86-532-8502-7205

China - Shanghai
Tel: 86-21-5407-5533
Fax: 86-21-5407-5066

China - Shenyang
Tel: 86-24-2334-2829
Fax: 86-24-2334-2393

China - Shenzhen
Tel: 86-755-8864-2200
Fax: 86-755-8203-1760

China - Wuhan
Tel: 86-27-5980-5300
Fax: 86-27-5980-5118

China - Xian
Tel: 86-29-8833-7252
Fax: 86-29-8833-7256

China - Xiamen
Tel: 86-592-2388138
Fax: 86-592-2388130

China - Zhuhai
Tel: 86-756-3210040
Fax: 86-756-3210049

ASIA/PACIFIC

India - Bangalore
Tel: 91-80-3090-4444
Fax: 91-80-3090-4123

India - New Delhi
Tel: 91-11-4160-8631
Fax: 91-11-4160-8632

India - Pune
Tel: 91-20-3019-1500

Japan - Osaka
Tel: 81-6-6152-7160
Fax: 81-6-6152-9310

Japan - Tokyo
Tel: 81-3-6880-3770
Fax: 81-3-6880-3771

Korea - Daegu
Tel: 82-53-744-4301
Fax: 82-53-744-4302

Korea - Seoul
Tel: 82-2-554-7200
Fax: 82-2-558-5932 or
82-2-558-5934

Malaysia - Kuala Lumpur
Tel: 60-3-6201-9857
Fax: 60-3-6201-9859

Malaysia - Penang
Tel: 60-4-227-8870
Fax: 60-4-227-4068

Philippines - Manila
Tel: 63-2-634-9065
Fax: 63-2-634-9069

Singapore
Tel: 65-6334-8870
Fax: 65-6334-8850

Taiwan - Hsin Chu
Tel: 886-3-5778-366
Fax: 886-3-5770-955

Taiwan - Kaohsiung
Tel: 886-7-213-7830

Taiwan - Taipei
Tel: 886-2-2508-8600
Fax: 886-2-2508-0102

Thailand - Bangkok
Tel: 66-2-694-1351
Fax: 66-2-694-1350

EUROPE

Austria - Wels
Tel: 43-7242-2244-39
Fax: 43-7242-2244-393

Denmark - Copenhagen
Tel: 45-4450-2828
Fax: 45-4485-2829

France - Paris
Tel: 33-1-69-53-63-20
Fax: 33-1-69-30-90-79

Germany - Dusseldorf
Tel: 49-2129-3766400

Germany - Munich
Tel: 49-89-627-144-0
Fax: 49-89-627-144-44

Germany - Pforzheim
Tel: 49-7231-424750

Italy - Milan
Tel: 39-0331-742611
Fax: 39-0331-466781

Italy - Venice
Tel: 39-049-7625286

Netherlands - Drunen
Tel: 31-416-690399
Fax: 31-416-690340

Poland - Warsaw
Tel: 48-22-3325737

Spain - Madrid
Tel: 34-91-708-08-90
Fax: 34-91-708-08-91

Sweden - Stockholm
Tel: 46-8-5090-4654

UK - Wokingham
Tel: 44-118-921-5800
Fax: 44-118-921-5820

03/25/14

Looking for pricing, stock, or lifecycle information?

Click below to explore more details on WIN SOURCE:

- ⊖ [View TC1267VETTR on WIN SOURCE](#)
- ⊖ [Microchip Technology](#) Information

Optimize Your Supply Chain with WIN SOURCE Solutions

- ✓ Global Sourcing Solution
- ✓ Obsolete Management
- ✓ Cost Control Management
- ✓ Shortage Management
- ✓ Alternative Solution
- ✓ Excess Inventory Management