



**THE DATASHEET OF  
AD8607ARMZ**



## AD8603/AD8607/AD8609

### FEATURES

**Low offset voltage: 50  $\mu$ V maximum**  
**Low input bias current: 1 pA maximum**  
**Single-supply operation: 1.8 V to 5 V**  
**Low noise: 22 nV/ $\sqrt$ Hz**  
**Micropower: 50  $\mu$ A maximum**  
**Low distortion**  
**No phase reversal**  
**Unity gain stable**

### APPLICATIONS

**Battery-powered instrumentation**  
**Multipole filters**  
**Sensors**  
**Low power ASIC input or output amplifiers**

### GENERAL DESCRIPTION

The AD8603/AD8607/AD8609 are single/dual/quad micro-power rail-to-rail input and output amplifiers, respectively, that feature very low offset voltage as well as low input voltage and current noise.

These amplifiers use a patented trimming technique that achieves superior precision without laser trimming. The parts are fully specified to operate from 1.8 V to 5.0 V single supply or from  $\pm 0.9$  V to  $\pm 2.5$  V dual supply. The combination of low offsets, low noise, very low input bias currents, and low power consumption makes the AD8603/AD8607/AD8609 especially useful in portable and loop-powered instrumentation.

The ability to swing rail to rail at both the input and output enables designers to buffer CMOS ADCs, DACs, ASICs, and other wide output swing devices in low power, single-supply systems.

The AD8603 is available in a tiny 5-lead TSOT package. The AD8607 is available in 8-lead MSOP and 8-lead SOIC packages. The AD8609 is available in 14-lead TSSOP and 14-lead SOIC packages.

### PIN CONFIGURATIONS

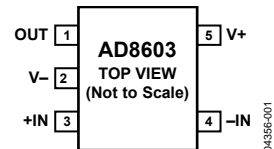

Figure 1. 5-Lead TSOT (UJ Suffix)



Figure 2. 8-Lead MSOP (RM Suffix)

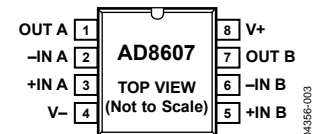

Figure 3. 8-Lead SOIC (R Suffix)

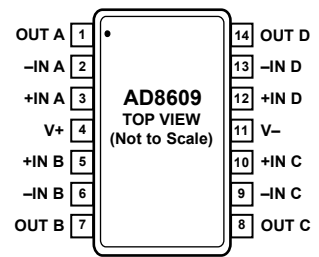

Figure 4. 14-Lead TSSOP (RU Suffix)

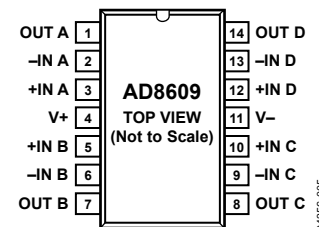

Figure 5. 14-Lead SOIC (R Suffix)

### Rev. C

Information furnished by Analog Devices is believed to be accurate and reliable. However, no responsibility is assumed by Analog Devices for its use, nor for any infringements of patents or other rights of third parties that may result from its use. Specifications subject to change without notice. No license is granted by implication or otherwise under any patent or patent rights of Analog Devices. Trademarks and registered trademarks are the property of their respective owners.

## **TABLE OF CONTENTS**

Features .....	1	Applications.....	12
Applications.....	1	No Phase Reversal.....	12
General Description .....	1	Input Overvoltage Protection .....	12
Pin Configurations .....	1	Driving Capacitive Loads.....	12
Revision History .....	2	Proximity Sensors.....	13
Specifications.....	3	Composite Amplifiers.....	13
Electrical Characteristics .....	3	Battery-Powered Applications .....	13
Absolute Maximum Ratings.....	5	Photodiodes .....	13
ESD Caution.....	5	Outline Dimensions .....	14
Typical Performance Characteristics .....	6	Ordering Guide .....	16

## **REVISION HISTORY**

### **6/08—Rev. B to Rev. C**

Changes to Table 1.....	3
Changes to Table 2.....	4
Changes to Figure 15.....	7
Changes to Figure 33.....	10
Changes to Figure 45 and Figure 47 .....	13
Updated Outline Dimensions .....	14
Changes to Ordering Guide .....	16

### **6/05—Rev. A to Rev. B**

Updated Figure 49 .....	15
Changes to Ordering Guide .....	17

### **10/03—Rev. 0 to Rev. A**

Added AD8607 and AD8609 Parts .....	Universal
Changes to Specifications .....	3
Changes to Figure 35.....	10
Added Figure 41.....	11

### **8/03—Revision 0: Initial Version**

# SPECIFICATIONS

## ELECTRICAL CHARACTERISTICS

$V_S = 5\text{ V}$ ,  $V_{CM} = V_S/2$ ,  $T_A = 25^\circ\text{C}$ , unless otherwise noted.

Table 1.

Parameter	Symbol	Conditions	Min	Typ	Max	Unit	
<b>INPUT CHARACTERISTICS</b>							
Offset Voltage	$V_{OS}$	$V_S = 3.3\text{ V}$ @ $V_{CM} = 0.5\text{ V}$ and $2.8\text{ V}$		12	50	$\mu\text{V}$	
		$-0.3\text{ V} < V_{CM} < +5.2\text{ V}$		40	300	$\mu\text{V}$	
		$-40^\circ\text{C} < T_A < +125^\circ\text{C}$ , $-0.3\text{ V} < V_{CM} < +5.2\text{ V}$				700	$\mu\text{V}$
Offset Voltage Drift	$\Delta V_{OS}/\Delta T$	$-40^\circ\text{C} < T_A < +125^\circ\text{C}$		1	4.5	$\mu\text{V}/^\circ\text{C}$	
Input Bias Current	$I_B$	$-40^\circ\text{C} < T_A < +85^\circ\text{C}$		0.2	1	$\text{pA}$	
		$-40^\circ\text{C} < T_A < +125^\circ\text{C}$				50	$\text{pA}$
						500	$\text{pA}$
Input Offset Current	$I_{OS}$	$-40^\circ\text{C} < T_A < +85^\circ\text{C}$		0.1	0.5	$\text{pA}$	
		$-40^\circ\text{C} < T_A < +125^\circ\text{C}$				50	$\text{pA}$
						250	$\text{pA}$
Input Voltage Range	IVR		-0.3		+5.2	V	
Common-Mode Rejection Ratio	CMRR	$0\text{ V} < V_{CM} < 5\text{ V}$	85	100		dB	
		$-40^\circ\text{C} < T_A < +125^\circ\text{C}$	80			dB	
Large Signal Voltage Gain AD8603	$A_{VO}$	$R_L = 10\text{ k}\Omega$ , $0.5\text{ V} < V_O < 4.5\text{ V}$	400	1000		V/mV	
			250	450		V/mV	
Input Capacitance	$C_{DIFF}$ $C_{CM}$			1.9		pF	
				2.5		pF	
<b>OUTPUT CHARACTERISTICS</b>							
Output Voltage High	$V_{OH}$	$I_L = 1\text{ mA}$	4.95	4.97		V	
		$-40^\circ\text{C}$ to $+125^\circ\text{C}$	4.9			V	
		$I_L = 10\text{ mA}$	4.65	4.97		V	
		$-40^\circ\text{C}$ to $+125^\circ\text{C}$	4.50			V	
Output Voltage Low	$V_{OL}$	$I_L = 1\text{ mA}$		16	30	mV	
		$-40^\circ\text{C}$ to $+125^\circ\text{C}$			50	mV	
		$I_L = 10\text{ mA}$		160	250	mV	
		$-40^\circ\text{C}$ to $+125^\circ\text{C}$			330	mV	
Short-Circuit Current	$I_{SC}$		$\pm 70$			mA	
Closed-Loop Output Impedance	$Z_{OUT}$	$f = 10\text{ kHz}$ , $A_V = 1$		36		$\Omega$	
<b>POWER SUPPLY</b>							
Power Supply Rejection Ratio	PSRR	$1.8\text{ V} < V_S < 5\text{ V}$	80	100		dB	
Supply Current per Amplifier	$I_{SY}$	$V_O = 0\text{ V}$		40	50	$\mu\text{A}$	
		$-40^\circ\text{C} < T_A < +125^\circ\text{C}$			60	$\mu\text{A}$	
<b>DYNAMIC PERFORMANCE</b>							
Slew Rate	SR	$R_L = 10\text{ k}\Omega$		0.1		V/ $\mu\text{s}$	
Settling Time 0.1%	$t_S$	$G = \pm 1$ , $2\text{ V}$ step		23		$\mu\text{s}$	
Gain Bandwidth Product	GBP	$R_L = 100\text{ k}\Omega$		400		kHz	
		$R_L = 10\text{ k}\Omega$		316		kHz	
Phase Margin	$\phi_O$	$R_L = 10\text{ k}\Omega$ , $R_L = 100\text{ k}\Omega$		70		Degrees	
<b>NOISE PERFORMANCE</b>							
Peak-to-Peak Noise	$e_{n\text{ p-p}}$	0.1 Hz to 10 Hz		2.3	3.5	$\mu\text{V}$	
Voltage Noise Density	$e_n$	$f = 1\text{ kHz}$		25		$\text{nV}/\sqrt{\text{Hz}}$	
		$f = 10\text{ kHz}$		22		$\text{nV}/\sqrt{\text{Hz}}$	
Current Noise Density	$i_n$	$f = 1\text{ kHz}$		0.05		$\text{pA}/\sqrt{\text{Hz}}$	
Channel Separation	$C_S$	$f = 10\text{ kHz}$		-115		dB	
		$f = 100\text{ kHz}$		-110		dB	

# AD8603/AD8607/AD8609

$V_S = 1.8\text{ V}$ ,  $V_{CM} = V_S/2$ ,  $T_A = 25^\circ\text{C}$ , unless otherwise noted.

**Table 2.**

Parameter	Symbol	Conditions	Min	Typ	Max	Unit
<b>INPUT CHARACTERISTICS</b>						
Offset Voltage	$V_{OS}$	$V_S = 3.3\text{ V}$ @ $V_{CM} = 0.5\text{ V}$ and $2.8\text{ V}$ $-0.3\text{ V} < V_{CM} < +1.8\text{ V}$ $-40^\circ\text{C} < T_A < +85^\circ\text{C}$ , $-0.3\text{ V} < V_{CM} < +1.8\text{ V}$ $-40^\circ\text{C} < T_A < +125^\circ\text{C}$ , $-0.3\text{ V} < V_{CM} < +1.7\text{ V}$		12	50	$\mu\text{V}$
				40	300	$\mu\text{V}$
					500	$\mu\text{V}$
					700	$\mu\text{V}$
Offset Voltage Drift	$\Delta V_{OS}/\Delta T$	$-40^\circ\text{C} < T_A < +125^\circ\text{C}$		1	4.5	$\mu\text{V}/^\circ\text{C}$
Input Bias Current	$I_B$	$-40^\circ\text{C} < T_A < +85^\circ\text{C}$ $-40^\circ\text{C} < T_A < +125^\circ\text{C}$		0.2	1	$\text{pA}$
					50	$\text{pA}$
					500	$\text{pA}$
Input Offset Current	$I_{OS}$	$-40^\circ\text{C} < T_A < +85^\circ\text{C}$ $-40^\circ\text{C} < T_A < +125^\circ\text{C}$		0.1	0.5	$\text{pA}$
					50	$\text{pA}$
					250	$\text{pA}$
Input Voltage Range	IVR		-0.3		+1.8	$\text{V}$
Common-Mode Rejection Ratio	CMRR	$0\text{ V} < V_{CM} < 1.8\text{ V}$ $-40^\circ\text{C} < T_A < +85^\circ\text{C}$	80	98		$\text{dB}$
			70			$\text{dB}$
Large Signal Voltage Gain	$A_{VO}$	$R_L = 10\text{ k}\Omega$ , $0.5\text{ V} < V_O < 4.5\text{ V}$				
AD8603			150	3000		$\text{V}/\text{mV}$
AD8607/AD8609			100	2000		$\text{V}/\text{mV}$
Input Capacitance	$C_{DIFF}$ $C_{CM}$			2.1		$\text{pF}$
				3.8		$\text{pF}$
<b>OUTPUT CHARACTERISTICS</b>						
Output Voltage High	$V_{OH}$	$I_L = 1\text{ mA}$ $-40^\circ\text{C}$ to $+125^\circ\text{C}$	1.65	1.72		$\text{V}$
			1.6			$\text{V}$
Output Voltage Low	$V_{OL}$	$I_L = 1\text{ mA}$ $-40^\circ\text{C}$ to $+125^\circ\text{C}$		38	60	$\text{mV}$
					80	$\text{mV}$
Short-Circuit Current	$I_{SC}$			$\pm 10$		$\text{mA}$
Closed-Loop Output Impedance	$Z_{OUT}$	$f = 10\text{ kHz}$ , $A_V = 1$		36		$\Omega$
<b>POWER SUPPLY</b>						
Power Supply Rejection Ratio	PSRR	$1.8\text{ V} < V_S < 5\text{ V}$	80	100		$\text{dB}$
Supply Current per Amplifier	$I_{SY}$	$V_O = 0\text{ V}$ $-40^\circ\text{C} < T_A < +85^\circ\text{C}$		40	50	$\mu\text{A}$
					60	$\mu\text{A}$
<b>DYNAMIC PERFORMANCE</b>						
Slew Rate	SR	$R_L = 10\text{ k}\Omega$		0.1		$\text{V}/\mu\text{s}$
Settling Time 0.1%	$t_S$	$G = \pm 1$ , $1\text{ V}$ step		9.2		$\mu\text{s}$
Gain Bandwidth Product	GBP	$R_L = 100\text{ k}\Omega$ $R_L = 10\text{ k}\Omega$		385		$\text{kHz}$
				316		$\text{kHz}$
Phase Margin	$\phi_O$	$R_L = 10\text{ k}\Omega$ , $R_L = 100\text{ k}\Omega$		70		Degrees
<b>NOISE PERFORMANCE</b>						
Peak-to-Peak Noise	$e_{n,p-p}$	$0.1\text{ Hz}$ to $10\text{ Hz}$		2.3	3.5	$\mu\text{V}$
Voltage Noise Density	$e_n$	$f = 1\text{ kHz}$ $f = 10\text{ kHz}$		25		$\text{nV}/\sqrt{\text{Hz}}$
				22		$\text{nV}/\sqrt{\text{Hz}}$
Current Noise Density	$i_n$	$f = 1\text{ kHz}$		0.05		$\text{pA}/\sqrt{\text{Hz}}$
Channel Separation	$C_S$	$f = 10\text{ kHz}$ $f = 100\text{ kHz}$		-115		$\text{dB}$
				-110		$\text{dB}$

## ABSOLUTE MAXIMUM RATINGS

Absolute maximum ratings apply at 25°C, unless otherwise noted.

Table 3.

Parameter	Rating
Supply Voltage	6 V
Input Voltage	GND to $V_S$
Differential Input Voltage	$\pm 6$ V
Output Short-Circuit Duration to GND	Indefinite
Storage Temperature Range	$-65^{\circ}\text{C}$ to $+150^{\circ}\text{C}$
Lead Temperature (Soldering, 60 sec)	$300^{\circ}\text{C}$
Operating Temperature Range	$-40^{\circ}\text{C}$ to $+125^{\circ}\text{C}$
Junction Temperature Range	$-65^{\circ}\text{C}$ to $+150^{\circ}\text{C}$

Stresses above those listed under Absolute Maximum Ratings may cause permanent damage to the device. This is a stress rating only; functional operation of the device at these or any other conditions above those indicated in the operational section of this specification is not implied. Exposure to absolute maximum rating conditions for extended periods may affect device reliability.

Table 4. Package Characteristics

Package Type	$\theta_{JA}^1$	$\theta_{JC}$	Unit
5-Lead TSOT (UJ)	207	61	$^{\circ}\text{C}/\text{W}$
8-Lead MSOP (RM)	210	45	$^{\circ}\text{C}/\text{W}$
8-Lead SOIC_N (R)	158	43	$^{\circ}\text{C}/\text{W}$
14-Lead SOIC_N (R)	120	36	$^{\circ}\text{C}/\text{W}$
14-Lead TSSOP (RU)	180	35	$^{\circ}\text{C}/\text{W}$

<sup>1</sup>  $\theta_{JA}$  is specified for the worst-case conditions, that is,  $\theta_{JA}$  is specified for a device soldered in a circuit board for surface-mount packages.

### ESD CAUTION



**ESD (electrostatic discharge) sensitive device.** Charged devices and circuit boards can discharge without detection. Although this product features patented or proprietary protection circuitry, damage may occur on devices subjected to high energy ESD. Therefore, proper ESD precautions should be taken to avoid performance degradation or loss of functionality.

TYPICAL PERFORMANCE CHARACTERISTICS

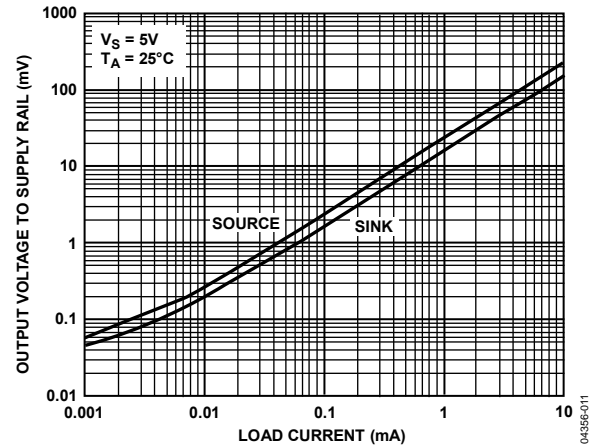
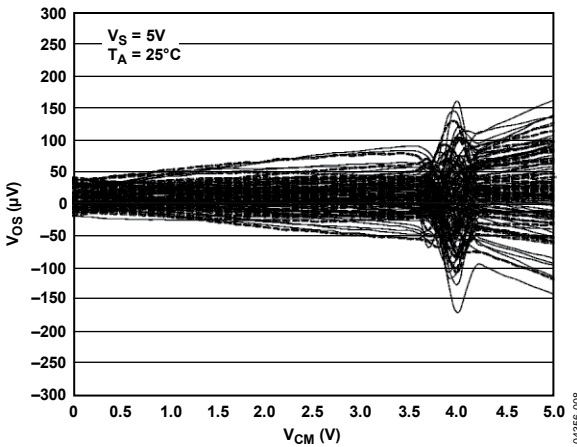
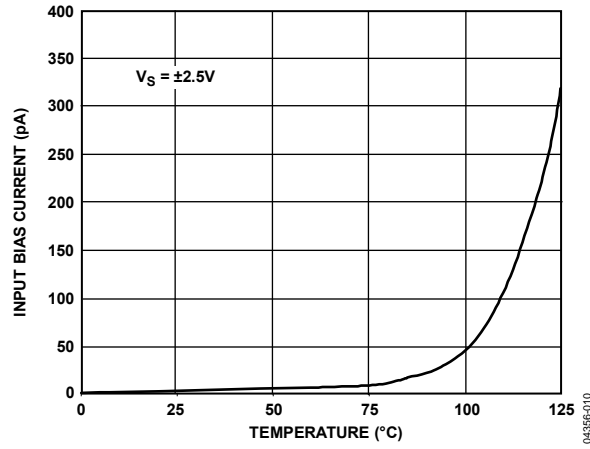
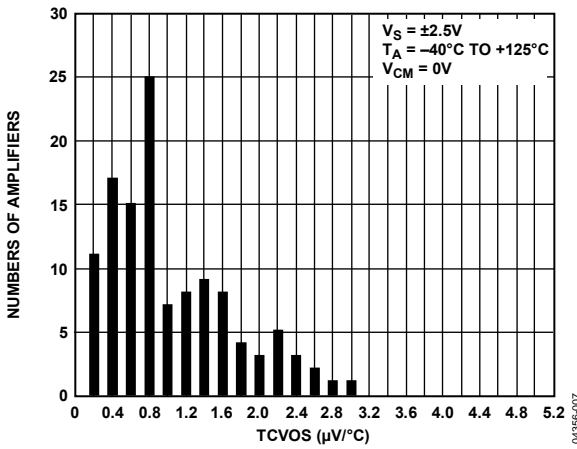
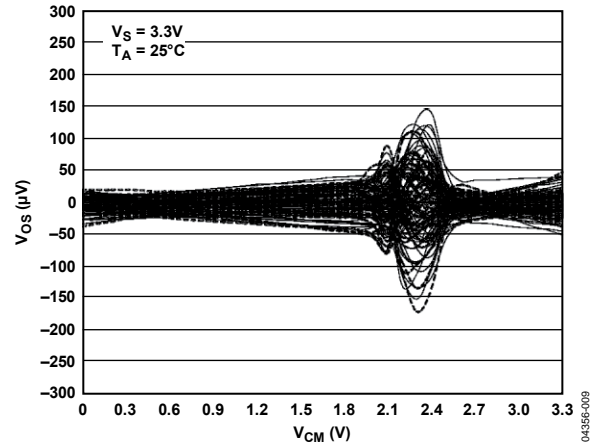
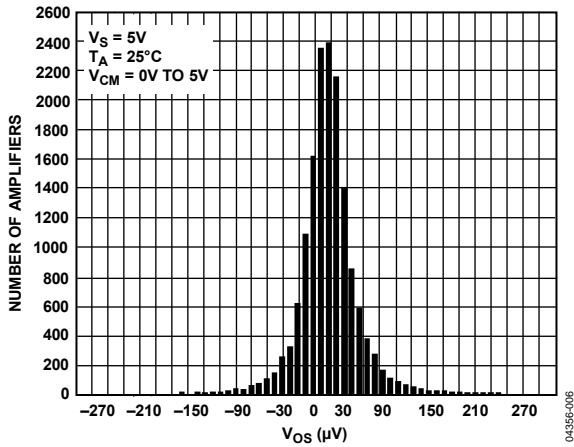

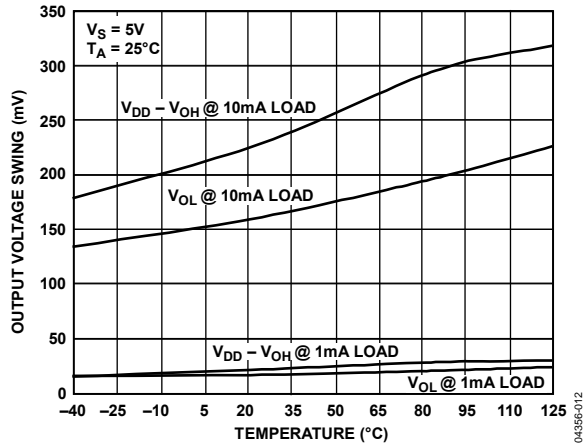

Figure 12. Output Voltage Swing vs. Temperature

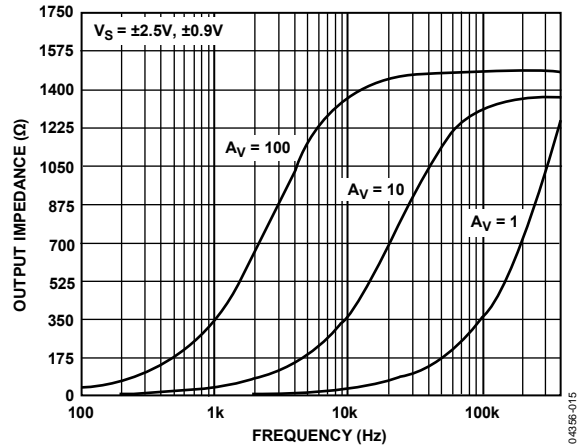

Figure 15. Output Impedance vs. Frequency

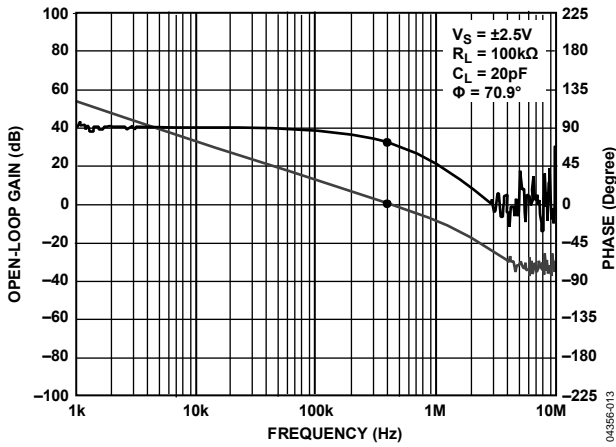

Figure 13. Open-Loop Gain and Phase vs. Frequency

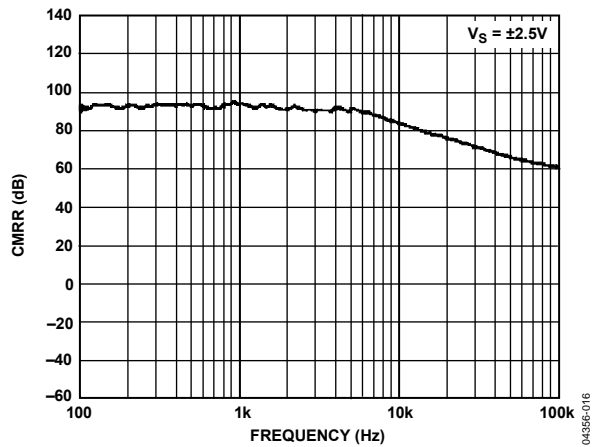

Figure 16. CMRR vs. Frequency

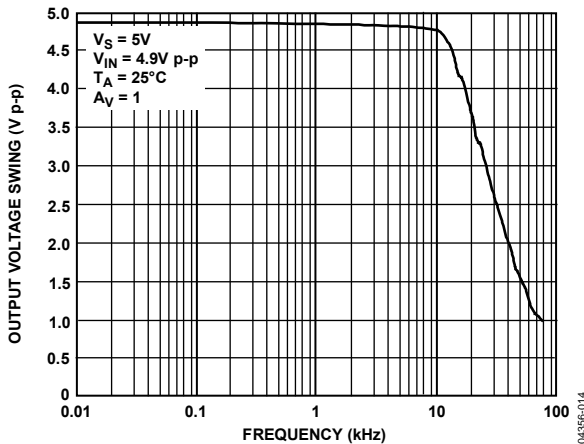

Figure 14. Closed-Loop Output Voltage Swing vs. Frequency

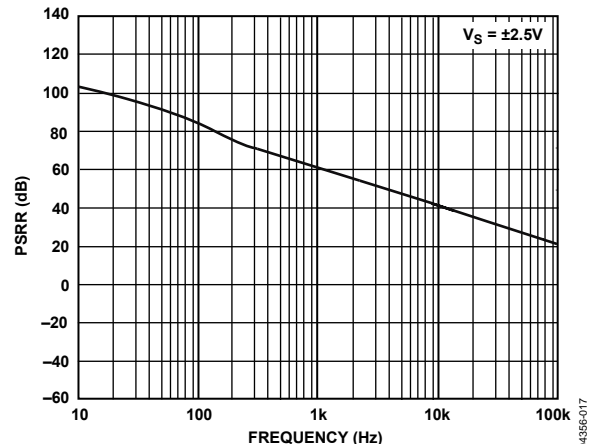

Figure 17. PSRR vs. Frequency

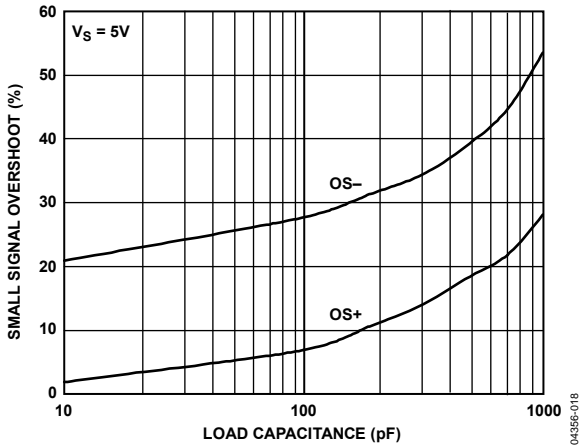

Figure 18. Small Signal Overshoot vs. Load Capacitance

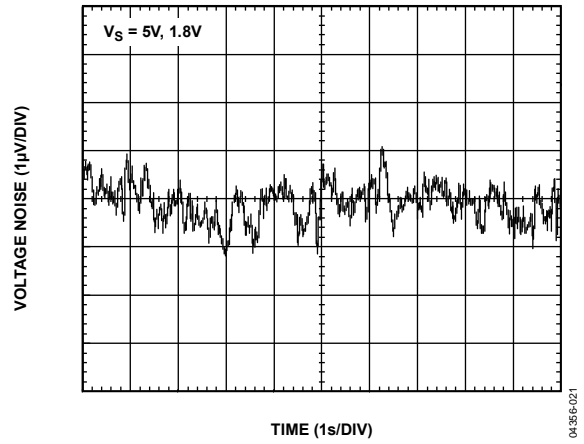

Figure 21. 0.1 Hz to 10 Hz Input Voltage Noise

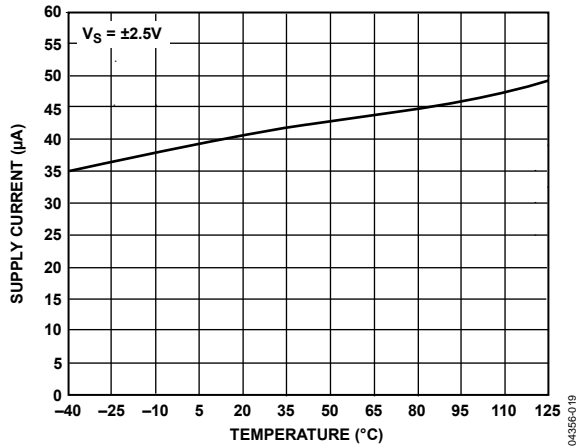

Figure 19. Supply Current vs. Temperature

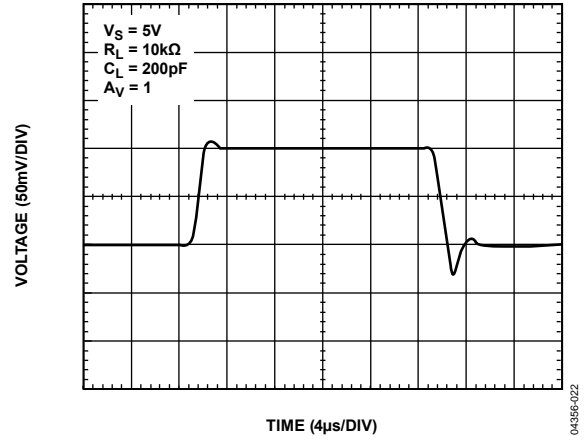

Figure 22. Small Signal Transient

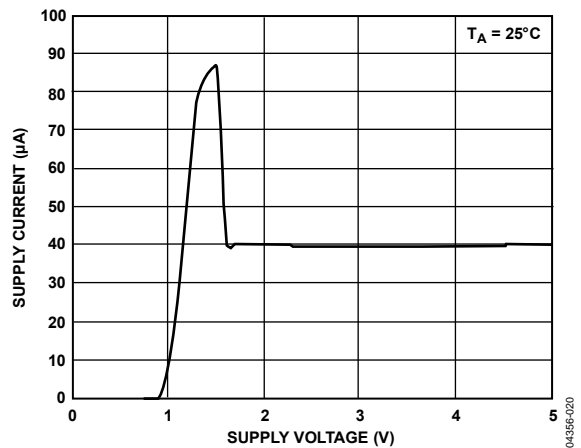

Figure 20. Supply Current vs. Supply Voltage

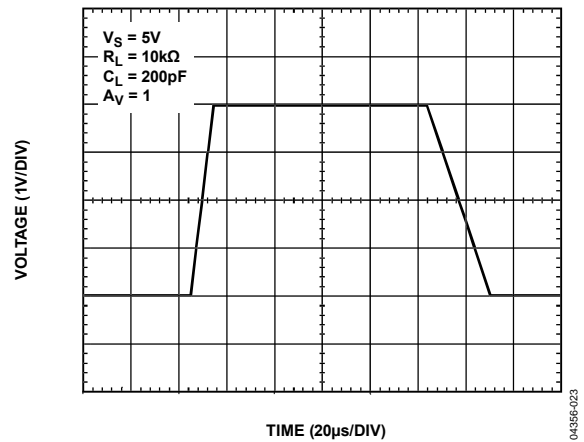

Figure 23. Large Signal Transient

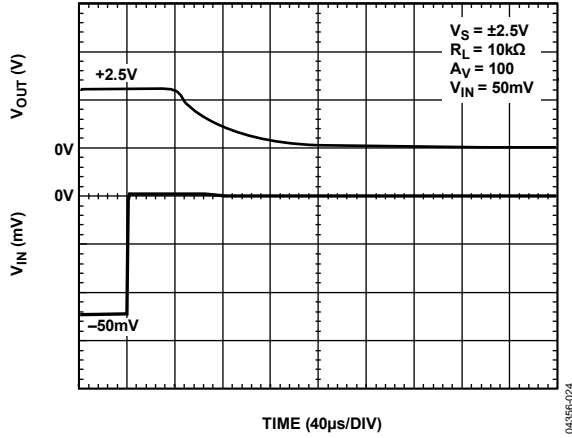

Figure 24. Negative Overload Recovery

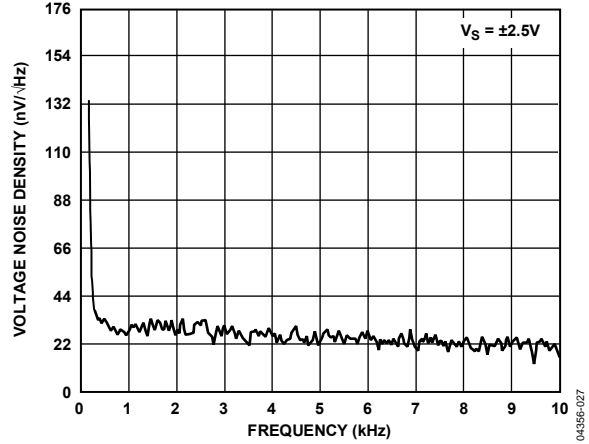

Figure 27. Voltage Noise Density vs. Frequency

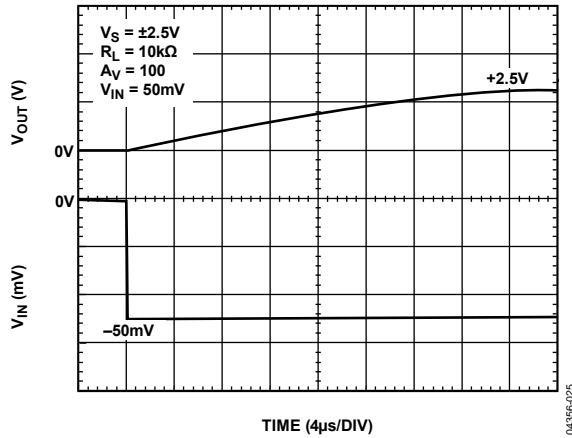

Figure 25. Positive Overload Recovery

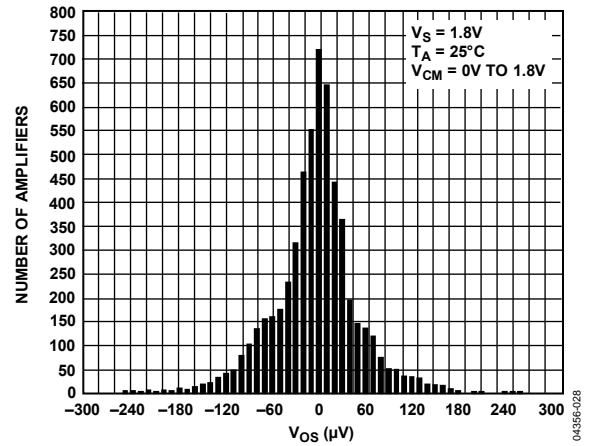

Figure 28.  $V_{OS}$  Distribution

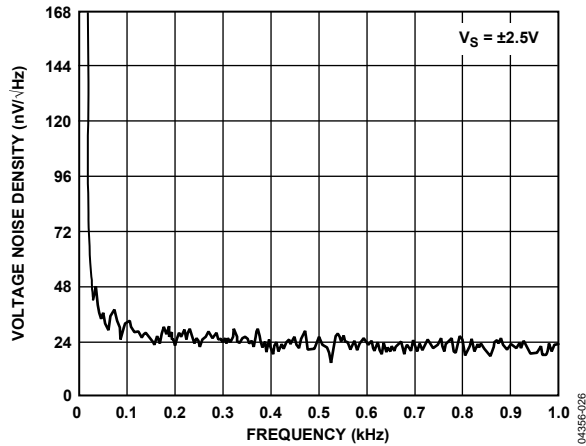

Figure 26. Voltage Noise Density vs. Frequency

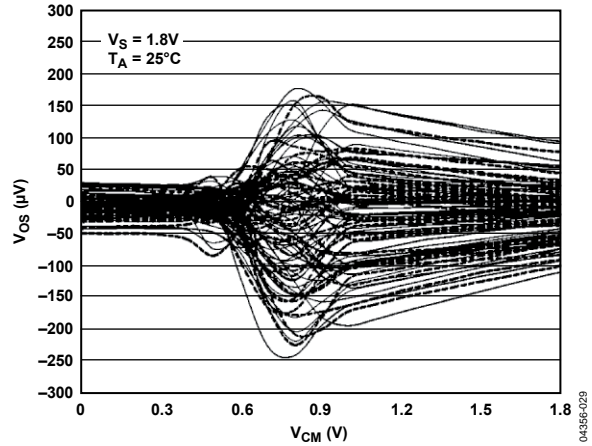

Figure 29. Input Offset Voltage vs. Common-Mode Voltage

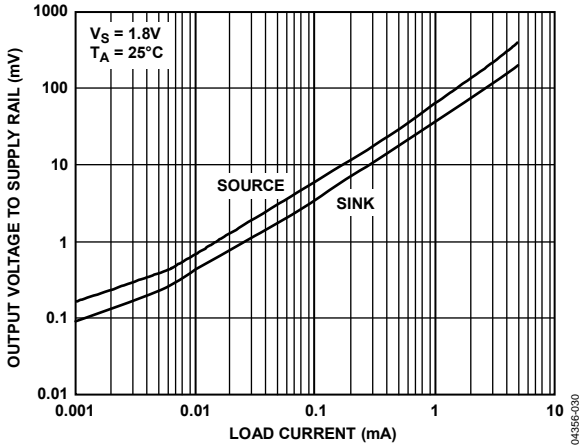

Figure 30. Output Voltage to Supply Rail vs. Load Current

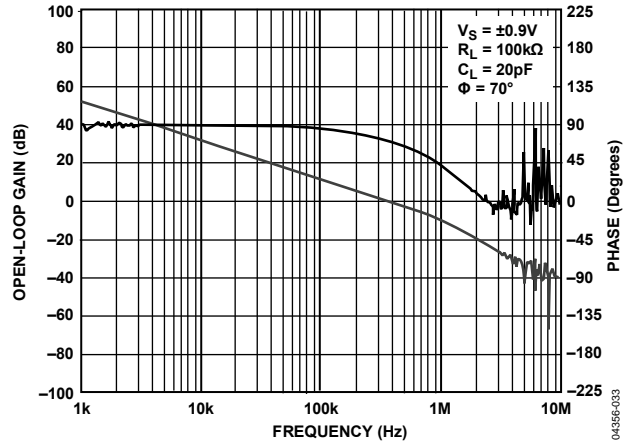

Figure 33. Open-Loop Gain and Phase vs. Frequency

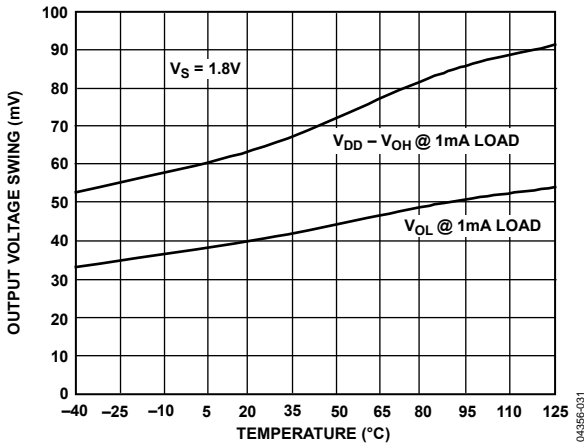

Figure 31. Output Voltage Swing vs. Temperature

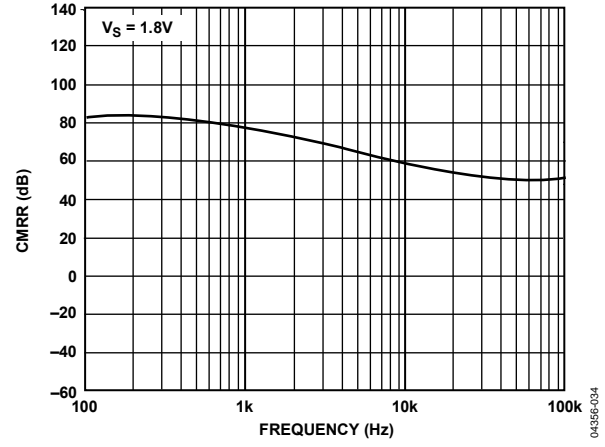

Figure 34. CMRR vs. Frequency

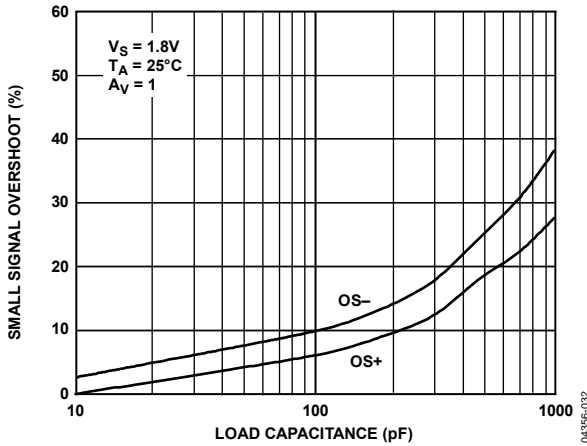

Figure 32. Small Signal Overshoot vs. Load Capacitance

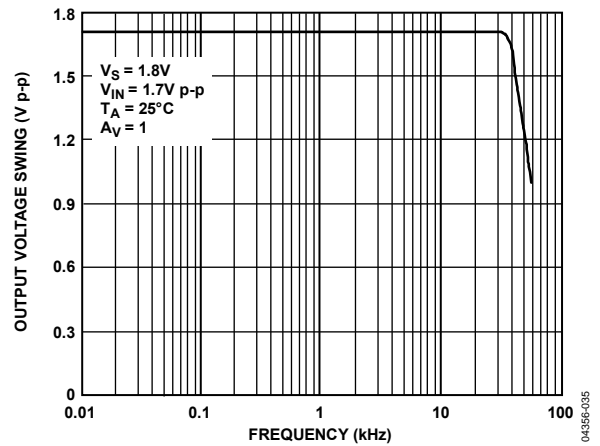

Figure 35. Closed-Loop Output Voltage Swing vs. Frequency

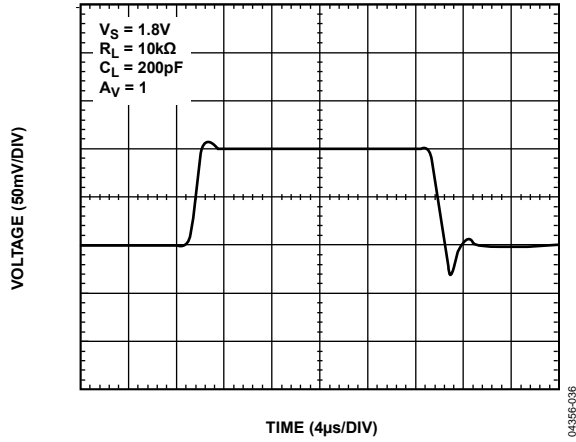

Figure 36. Small Signal Transient

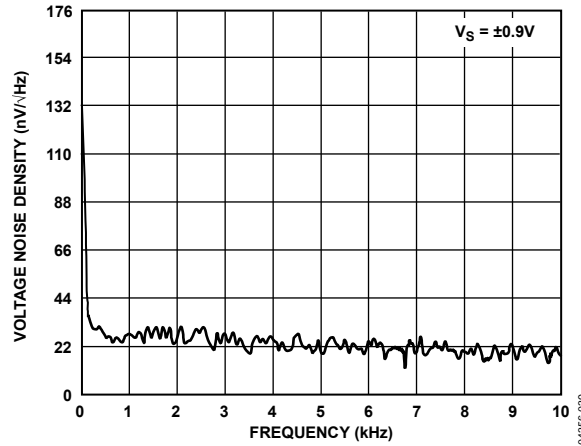

Figure 39. Voltage Noise Density vs. Frequency

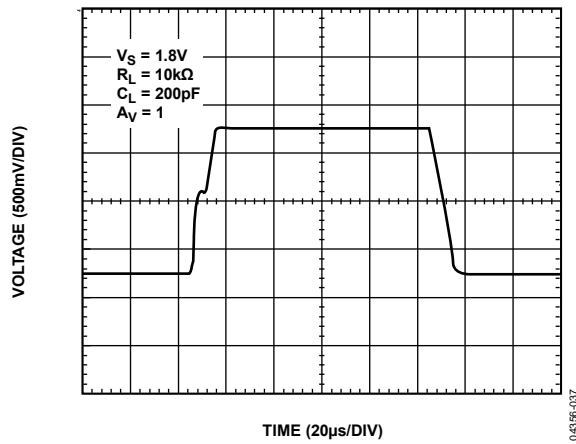

Figure 37. Large Signal Transient

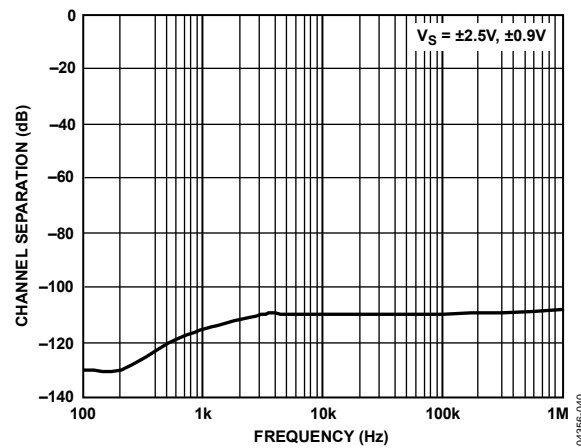

Figure 40. Channel Separation vs. Frequency

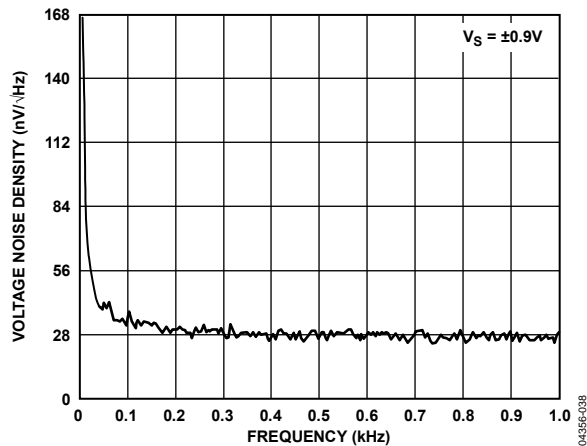

Figure 38. Voltage Noise Density vs. Frequency

## APPLICATIONS

### NO PHASE REVERSAL

The AD8603/AD8607/AD8609 do not exhibit phase inversion even when the input voltage exceeds the maximum input common-mode voltage. Phase reversal can cause permanent damage to the amplifier, resulting in system lockups. The AD8603/AD8607/AD8609 can handle voltages of up to 1 V over the supply.

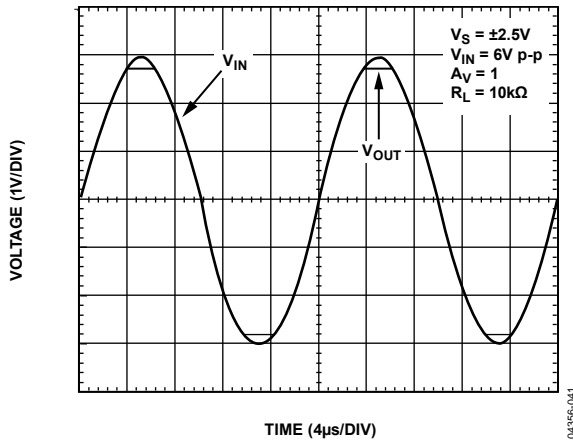

Figure 41. No Phase Response

### INPUT OVERVOLTAGE PROTECTION

If a voltage 1 V higher than the supplies is applied at either input, the use of a limiting series resistor is recommended. If both inputs are used, each one should be protected with a series resistor.

To ensure good protection, the current should be limited to a maximum of 5 mA. The value of the limiting resistor can be determined from the following equation:

$$(V_{IN} - V_S)/(R_S + 200 \Omega) \leq 5 \text{ mA}$$

### DRIVING CAPACITIVE LOADS

The AD8603/AD8607/AD8609 are capable of driving large capacitive loads without oscillating. Figure 42 shows the output of the AD8603/AD8607/AD8609 in response to a 100 mV input signal, with a 2 nF capacitive load.

Although it is configured in positive unity gain (the worst case), the AD8603 shows less than 20% overshoot. Simple additional circuitry can eliminate ringing and overshoot.

One technique is the snubber network, which consists of a series RC and a resistive load (see Figure 43). With the snubber in place, the AD8603/AD8607/AD8609 are capable of driving capacitive loads of 2 nF with no ringing and less than 3% overshoot.

The use of the snubber circuit is usually recommended for unity gain configurations. Higher gain configurations help improve the stability of the circuit. Figure 44 shows the same output response with the snubber in place.

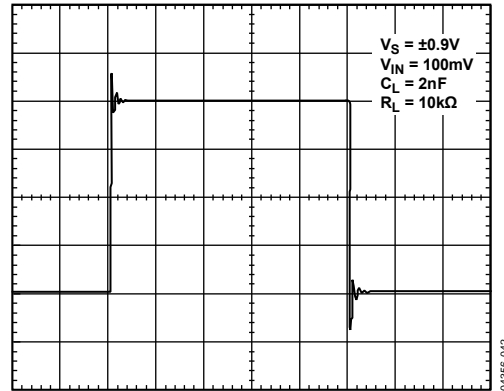

Figure 42. Output Response to a 2 nF Capacitive Load, Without Snubber

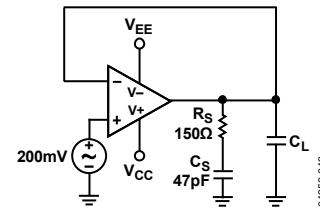

Figure 43. Snubber Network

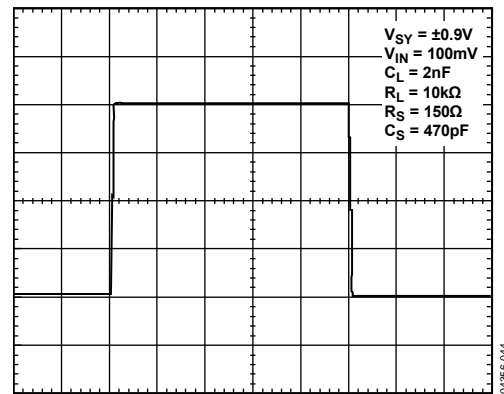

Figure 44. Output Response to a 2 nF Capacitive Load with Snubber

Optimum values for  $R_S$  and  $C_S$  are determined empirically; Table 5 lists a few starting values.

**Table 5. Optimum Values for the Snubber Network**

$C_L$ (pF)	$R_S$ ( $\Omega$ )	$C_S$ (pF)
100 to ~500	500	680
1500	100	330
1600 to ~2000	400	100

## PROXIMITY SENSORS

Proximity sensors can be capacitive or inductive and are used in a variety of applications. One of the most common applications is liquid level sensing in tanks. This is particularly popular in pharmaceutical environments where a tank must know when to stop filling or mixing a given liquid. In aerospace applications, these sensors detect the level of oxygen used to propel engines. Whether in a combustible environment or not, capacitive sensors generally use low voltage. The precision and low voltage of the AD8603/AD8607/AD8609 make the parts an excellent choice for such applications.

## COMPOSITE AMPLIFIERS

A composite amplifier can provide a very high gain in applications where high closed-loop dc gains are needed. The high gain achieved by the composite amplifier comes at the expense of a loss in phase margin. Placing a small capacitor,  $C_F$ , in the feedback in parallel with  $R_2$  (see Figure 45) improves the phase margin. Picking  $C_F = 50$  pF yields a phase margin of about  $45^\circ$  for the values shown in Figure 45.

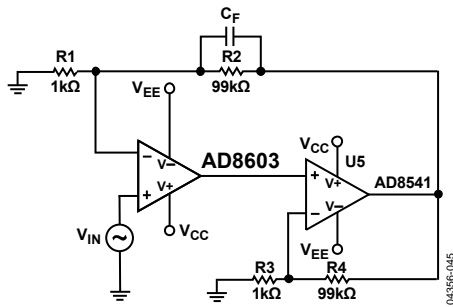

Figure 45. High Gain Composite Amplifier

A composite amplifier can be used to optimize dc and ac characteristics. Figure 46 shows an example using the AD8603 and the AD8541. This circuit offers many advantages. The bandwidth is increased substantially, and the input offset voltage and noise of the AD8541 become insignificant because they are divided by the high gain of the AD8603.

The circuit in Figure 46 offers high bandwidth (nearly double that of the AD8603), high output current, and very low power consumption of less than 100  $\mu$ A.

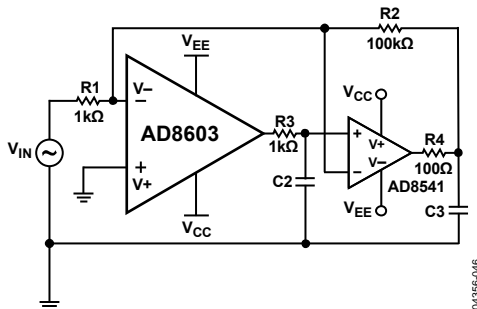

Figure 46. Low Power Composite Amplifier

## BATTERY-POWERED APPLICATIONS

The AD8603/AD8607/AD8609 are ideal for battery-powered applications. The parts are tested at 5 V, 3.3 V, 2.7 V, and 1.8 V and are suitable for various applications whether in single or dual supply.

In addition to their low offset voltage and low input bias, the AD8603/AD8607/AD8609 have a very low supply current of 40  $\mu$ A, making the parts an excellent choice for portable electronics. The TSOT package allows the AD8603 to be used on smaller board spaces.

## PHOTODIODES

Photodiodes have a wide range of applications from barcode scanners to precision light meters and CAT scanners. The very low noise and low input bias current of the AD8603/AD8607/AD8609 make the parts very attractive amplifiers for I-V conversion applications.

Figure 47 shows a simple photodiode circuit. The feedback capacitor helps the circuit maintain stability. The signal bandwidth can be increased at the expense of an increase in the total noise; a low-pass filter can be implemented by a simple RC network at the output to reduce the noise. The signal bandwidth can be calculated by  $\frac{1}{2}\pi R_2 C_2$ , and the closed-loop bandwidth is the intersection point of the open-loop gain and the noise gain.

The circuit shown in Figure 47 has a closed-loop bandwidth of 58 kHz and a signal bandwidth of 16 Hz. Increasing  $C_2$  to 50 pF yields a closed-loop bandwidth of 65 kHz, but only 3.2 Hz of signal bandwidth can be achieved.

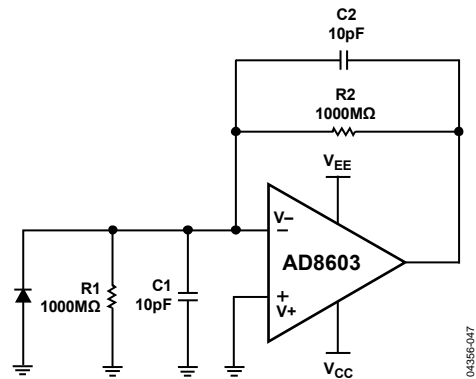
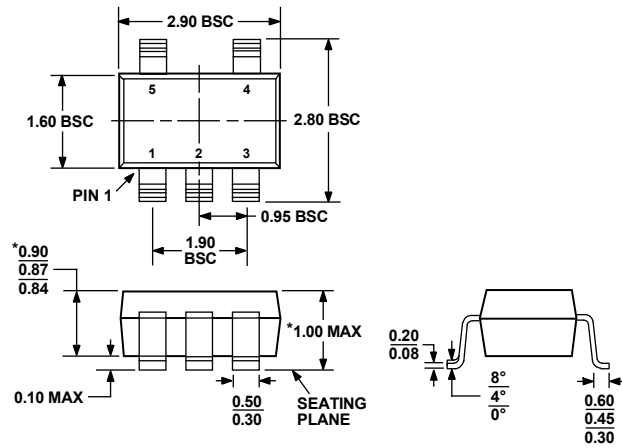

Figure 47. Photodiode Circuit

OUTLINE DIMENSIONS



\*COMPLIANT TO JEDEC STANDARDS MO-193-AB WITH THE EXCEPTION OF PACKAGE HEIGHT AND THICKNESS.

Figure 48. 5-Lead Thin Small Outline Transistor Package [TSOT] (UJ-5)  
Dimensions shown in millimeters

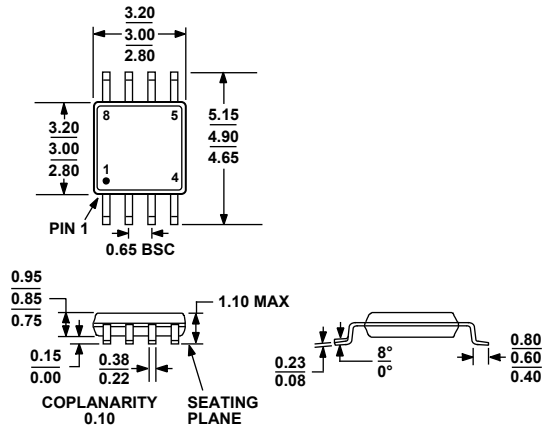

COMPLIANT TO JEDEC STANDARDS MO-187-AA

Figure 49. 8-Lead Mini Small Outline Package [MSOP] (RM-8)  
Dimensions shown in millimeters

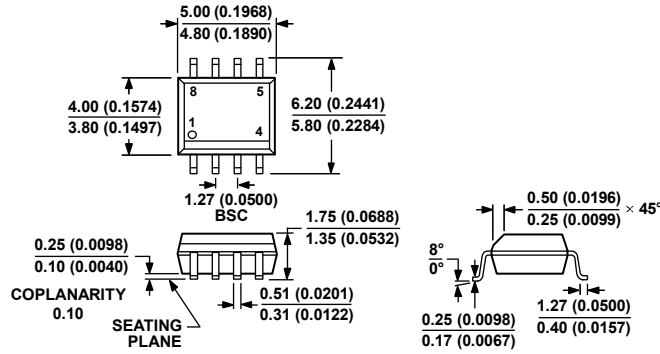

COMPLIANT TO JEDEC STANDARDS MS-012-AA  
 CONTROLLING DIMENSIONS ARE IN MILLIMETERS; INCH DIMENSIONS (IN PARENTHESES) ARE ROUNDED-OFF MILLIMETER EQUIVALENTS FOR REFERENCE ONLY AND ARE NOT APPROPRIATE FOR USE IN DESIGN.

Figure 50. 8-Lead Standard Small Outline Package [SOIC\_N] (R-8)

Dimensions shown in millimeters and (inches)

012A07-A

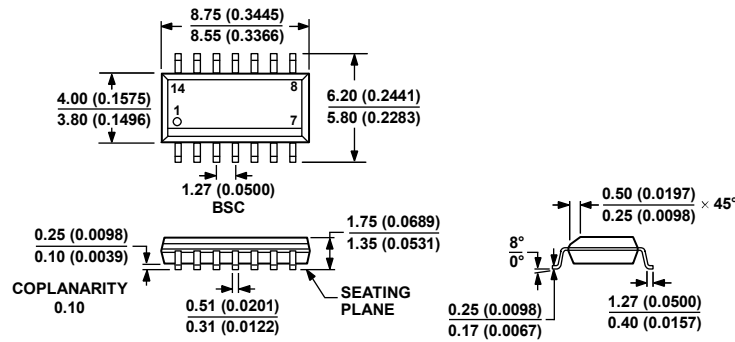

COMPLIANT TO JEDEC STANDARDS MS-012-AB  
 CONTROLLING DIMENSIONS ARE IN MILLIMETERS; INCH DIMENSIONS (IN PARENTHESES) ARE ROUNDED-OFF MILLIMETER EQUIVALENTS FOR REFERENCE ONLY AND ARE NOT APPROPRIATE FOR USE IN DESIGN.

Figure 51. 14-Lead Standard Small Outline Package [SOIC\_N] (R-14)

Dimensions shown in millimeters and (inches)

060606-A

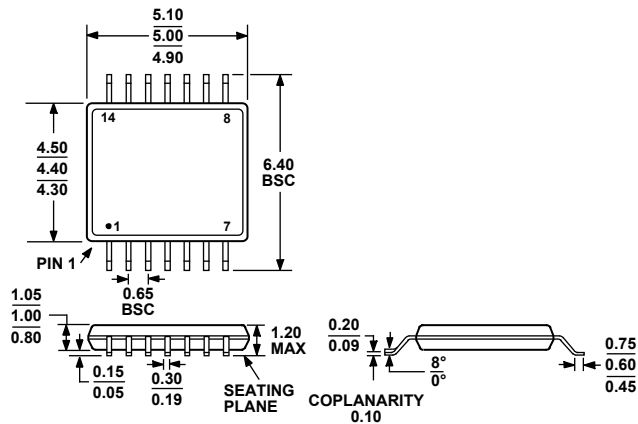

COMPLIANT TO JEDEC STANDARDS MO-153-AB-1

Figure 52. 14-Lead Thin Shrink Small Outline Package [TSSOP] (RU-14)

Dimensions shown in millimeters

# AD8603/AD8607/AD8609

## ORDERING GUIDE

Model	Temperature Range	Package Description	Package Option	Branding
AD8603AUJ-R2	-40°C to +125°C	5-Lead TSOT	UJ-5	BFA
AD8603AUJ-REEL	-40°C to +125°C	5-Lead TSOT	UJ-5	BFA
AD8603AUJ-REEL7	-40°C to +125°C	5-Lead TSOT	UJ-5	BFA
AD8603AUJZ-R2 <sup>1</sup>	-40°C to +125°C	5-Lead TSOT	UJ-5	A0X
AD8603AUJZ-REEL <sup>1</sup>	-40°C to +125°C	5-Lead TSOT	UJ-5	A0X
AD8603AUJZ-REEL7 <sup>1</sup>	-40°C to +125°C	5-Lead TSOT	UJ-5	A0X
AD8607ARM-R2	-40°C to +125°C	8-Lead MSOP	RM-8	A00
AD8607ARM-REEL	-40°C to +125°C	8-Lead MSOP	RM-8	A00
AD8607ARMZ-R2 <sup>1</sup>	-40°C to +125°C	8-Lead MSOP	RM-8	A0G
AD8607ARMZ-REEL <sup>1</sup>	-40°C to +125°C	8-Lead MSOP	RM-8	A0G
AD8607AR	-40°C to +125°C	8-Lead SOIC_N	R-8	
AD8607AR-REEL	-40°C to +125°C	8-Lead SOIC_N	R-8	
AD8607AR-REEL7	-40°C to +125°C	8-Lead SOIC_N	R-8	
AD8607ARZ <sup>1</sup>	-40°C to +125°C	8-Lead SOIC_N	R-8	
AD8607ARZ-REEL <sup>1</sup>	-40°C to +125°C	8-Lead SOIC_N	R-8	
AD8607ARZ-REEL7 <sup>1</sup>	-40°C to +125°C	8-Lead SOIC_N	R-8	
AD8609AR	-40°C to +125°C	14-Lead SOIC_N	R-14	
AD8609AR-REEL	-40°C to +125°C	14-Lead SOIC_N	R-14	
AD8609AR-REEL7	-40°C to +125°C	14-Lead SOIC_N	R-14	
AD8609ARZ <sup>1</sup>	-40°C to +125°C	14-Lead SOIC_N	R-14	
AD8609ARZ-REEL <sup>1</sup>	-40°C to +125°C	14-Lead SOIC_N	R-14	
AD8609ARZ-REEL7 <sup>1</sup>	-40°C to +125°C	14-Lead SOIC_N	R-14	
AD8609ARU	-40°C to +125°C	14-Lead TSSOP	RU-14	
AD8609ARU-REEL	-40°C to +125°C	14-Lead TSSOP	RU-14	
AD8609ARUZ <sup>1</sup>	-40°C to +125°C	14-Lead TSSOP	RU-14	
AD8609ARUZ-REEL <sup>1</sup>	-40°C to +125°C	14-Lead TSSOP	RU-14	

<sup>1</sup> Z = RoHS Compliant Part.

## Looking for pricing, stock, or lifecycle information?

Click below to explore more details on WIN SOURCE:

- ⊖ [View AD8607ARMZ on WIN SOURCE](#)
- ⊖ [Analog Devices Inc. Information](#)

## Optimize Your Supply Chain with WIN SOURCE Solutions

- ✓ Global Sourcing Solution
- ✓ Obsolete Management
- ✓ Cost Control Management
- ✓ Shortage Management
- ✓ Alternative Solution
- ✓ Excess Inventory Management