



**THE DATASHEET OF
BZB84-C15,215**



Important notice

Dear Customer,

On 7 February 2017 the former NXP Standard Product business became a new company with the tradename **Nexperia**. Nexperia is an industry leading supplier of Discrete, Logic and PowerMOS semiconductors with its focus on the automotive, industrial, computing, consumer and wearable application markets

In data sheets and application notes which still contain NXP or Philips Semiconductors references, use the references to Nexperia, as shown below.

Instead of <http://www.nxp.com>, <http://www.philips.com/> or <http://www.semiconductors.philips.com/>, use <http://www.nexperia.com>

Instead of sales.addresses@www.nxp.com or sales.addresses@www.semiconductors.philips.com, use salesaddresses@nexperia.com (email)

Replace the copyright notice at the bottom of each page or elsewhere in the document, depending on the version, as shown below:

- © NXP N.V. (year). All rights reserved or © Koninklijke Philips Electronics N.V. (year). All rights reserved

Should be replaced with:

- © **Nexperia B.V. (year). All rights reserved.**

If you have any questions related to the data sheet, please contact our nearest sales office via e-mail or telephone (details via salesaddresses@nexperia.com). Thank you for your cooperation and understanding,

Kind regards,

Team Nexperia

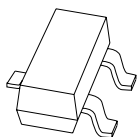

BZB84 series

Dual Zener diodes

Rev. 03 — 9 June 2009

Product data sheet

1. Product profile

1.1 General description

General-purpose Zener diodes in a SOT23 (TO-236AB) small Surface-Mounted Device (SMD) plastic package.

1.2 Features

- Non-repetitive peak reverse power dissipation: ≤ 40 W
- Total power dissipation: ≤ 300 mW
- Two tolerance series:
B = ± 2 % and C = ± 5 %
- Wide working voltage range:
nominal 2.4 V to 75 V (E24 range)
- Small plastic package suitable for surface-mounted design
- Dual common anode configuration
- AEC-Q101 qualified

1.3 Applications

- General regulation functions

1.4 Quick reference data

Table 1. Quick reference data

Symbol	Parameter	Conditions	Min	Typ	Max	Unit
Per diode						
V_F	forward voltage	$I_F = 10$ mA	[1] -	-	0.9	V
P_{ZSM}	non-repetitive peak reverse power dissipation		[2] -	-	40	W

[1] Pulse test: $t_p \leq 300$ μ s; $\delta \leq 0.02$.

[2] $t_p = 100$ μ s; square wave; $T_j = 25$ °C prior to surge

2. Pinning information

Table 2. Pinning

Pin	Description	Simplified outline	Graphic symbol
1	cathode (diode 1)		
2	cathode (diode 2)		
3	common anode		

006aaa154

3. Ordering information

Table 3. Ordering information

Type number	Package		
	Name	Description	Version
BZB84-B2V4 to BZB84-C75 ^[1]	-	plastic surface-mounted package; 3 leads	SOT23

[1] The series consists of 74 types with nominal working voltages from 2.4 V to 75 V.

4. Marking

Table 4. Marking codes

Type number	Marking code ^[1]	Type number	Marking code ^[1]
BZB84-B2V4	V9*	BZB84-C2V4	U9*
BZB84-B2V7	VA*	BZB84-C2V7	UA*
BZB84-B3V0	VB*	BZB84-C3V0	UB*
BZB84-B3V3	VC*	BZB84-C3V3	UC*
BZB84-B3V6	VD*	BZB84-C3V6	UD*
BZB84-B3V9	VE*	BZB84-C3V9	UE*
BZB84-B4V3	VF*	BZB84-C4V3	UF*
BZB84-B4V7	VG*	BZB84-C4V7	UG*
BZB84-B5V1	VH*	BZB84-C5V1	UH*
BZB84-B5V6	VK*	BZB84-C5V6	UK*
BZB84-B6V2	VL*	BZB84-C6V2	UL*
BZB84-B6V8	VM*	BZB84-C6V8	UM*
BZB84-B7V5	VN*	BZB84-C7V5	UN*
BZB84-B8V2	VP*	BZB84-C8V2	UP*
BZB84-B9V1	VR*	BZB84-C9V1	UR*

Table 4. Marking codes ...continued

Type number	Marking code ^[1]	Type number	Marking code ^[1]
BZB84-B10	VS*	BZB84-C10	US*
BZB84-B11	VT*	BZB84-C11	UT*
BZB84-B12	VU*	BZB84-C12	UU*
BZB84-B13	VV*	BZB84-C13	UV*
BZB84-B15	VW*	BZB84-C15	UW*
BZB84-B16	PT*	BZB84-C16	PB*
BZB84-B18	PU*	BZB84-C18	PC*
BZB84-B20	RP*	BZB84-C20	RQ*
BZB84-B22	PV*	BZB84-C22	PD*
BZB84-B24	PW*	BZB84-C24	PE*
BZB84-B27	PX*	BZB84-C27	PF*
BZB84-B30	PY*	BZB84-C30	PG*
BZB84-B33	PZ*	BZB84-C33	PH*
BZB84-B36	RA*	BZB84-C36	PJ*
BZB84-B39	RB*	BZB84-C39	PK*
BZB84-B43	RC*	BZB84-C43	PL*
BZB84-B47	RD*	BZB84-C47	PM*
BZB84-B51	RE*	BZB84-C51	PN*
BZB84-B56	RF*	BZB84-C56	PP*
BZB84-B62	RG*	BZB84-C62	PQ*
BZB84-B68	RH*	BZB84-C68	PR*
BZB84-B75	RJ*	BZB84-C75	PS*

[1] * = -: made in Hong Kong
 * = p: made in Hong Kong
 * = t: made in Malaysia
 * = W: made in China

5. Limiting values

Table 5. Limiting values

In accordance with the Absolute Maximum Rating System (IEC 60134).

Symbol	Parameter	Conditions	Min	Max	Unit
Per diode					
I_F	forward current		-	200	mA
I_{ZSM}	non-repetitive peak reverse current		[1] -	see Table 8 , 9 , 10 and 11	
P_{ZSM}	non-repetitive peak reverse power dissipation		[1] -	40	W

Table 5. Limiting values ...continued

In accordance with the Absolute Maximum Rating System (IEC 60134).

Symbol	Parameter	Conditions	Min	Max	Unit
Per device					
P_{tot}	total power dissipation	$T_{amb} \leq 25\text{ °C}$	[2] -	300	mW
T_j	junction temperature		-	150	°C
T_{amb}	ambient temperature		-55	+150	°C
T_{stg}	storage temperature		-65	+150	°C

[1] $t_p = 100\text{ }\mu\text{s}$; square wave; $T_j = 25\text{ °C}$ prior to surge

[2] Device mounted on an FR4 Printed-Circuit Board (PCB), single-sided copper, tin-plated and standard footprint.

6. Thermal characteristics

Table 6. Thermal characteristics

Symbol	Parameter	Conditions	Min	Typ	Max	Unit
Per device; single diode loaded						
$R_{th(j-a)}$	thermal resistance from junction to ambient	in free air	[1] -	-	417	K/W
$R_{th(j-sp)}$	thermal resistance from junction to solder point		[2] -	-	100	K/W

[1] Device mounted on an FR4 PCB, single-sided copper, tin-plated and standard footprint.

[2] Soldering points at pins 1 and 2.

7. Characteristics

Table 7. Characteristics $T_j = 25\text{ °C}$ unless otherwise specified.

Symbol	Parameter	Conditions	Min	Typ	Max	Unit
Per diode						
V_F	forward voltage	$I_F = 10\text{ mA}$	[1] -	-	0.9	V

[1] Pulse test: $t_p \leq 300\text{ }\mu\text{s}$; $\delta \leq 0.02$.

Table 8. Characteristics per type; BZB84-B2V4 to BZB84-B24 $T_j = 25\text{ }^\circ\text{C}$ unless otherwise specified.

BZB84-Bxxx	Working voltage V_Z (V)		Differential resistance r_{dif} (Ω)		Reverse current I_R (μA)		Temperature coefficient S_Z (mV/K)		Diode capacitance C_d (pF) ^[1]	Non-repetitive peak reverse current I_{ZSM} (A) ^[2]
	$I_Z = 5\text{ mA}$		$I_Z = 1\text{ mA}$	$I_Z = 5\text{ mA}$	Max	V_R (V)	$I_Z = 5\text{ mA}$			
	Min	Max	Max	Max			Min	Max	Max	Max
2V4	2.35	2.45	600	100	50	1	-3.5	0	450	6.0
2V7	2.65	2.75	600	100	20	1	-3.5	0	450	6.0
3V0	2.94	3.06	600	95	10	1	-3.5	0	450	6.0
3V3	3.23	3.37	600	95	5	1	-3.5	0	450	6.0
3V6	3.53	3.67	600	90	5	1	-3.5	0	450	6.0
3V9	3.82	3.98	600	90	3	1	-3.5	0	450	6.0
4V3	4.21	4.39	600	90	3	1	-3.5	0	450	6.0
4V7	4.61	4.79	500	80	3	2	-3.5	0.2	300	6.0
5V1	5.00	5.20	480	60	2	2	-2.7	1.2	300	6.0
5V6	5.49	5.71	400	40	1	2	-2.0	2.5	300	6.0
6V2	6.08	6.32	150	10	3	4	0.4	3.7	200	6.0
6V8	6.66	6.94	80	15	2	4	1.2	4.5	200	6.0
7V5	7.35	7.65	80	15	1	5	2.5	5.3	150	4.0
8V2	8.04	8.36	80	15	0.70	5	3.2	6.2	150	4.0
9V1	8.92	9.28	100	15	0.50	6	3.8	7.0	150	3.0
10	9.80	10.20	150	20	0.20	7	4.5	8.0	90	3.0
11	10.80	11.20	150	20	0.10	8	5.4	9.0	85	2.5
12	11.80	12.20	150	25	0.10	8	6.0	10.0	85	2.5
13	12.70	13.30	170	30	0.10	8	7.0	11.0	80	2.5
15	14.70	15.30	200	30	0.05	10.5	9.2	13.0	75	2.0
16	15.70	16.30	200	40	0.05	11.2	10.4	14.0	75	1.5
18	17.60	18.40	225	45	0.05	12.6	12.4	16.0	70	1.5
20	19.6	20.4	225	55	0.05	14.0	14.4	18.0	60	1.5
22	21.6	22.4	250	55	0.05	15.4	16.4	20.0	60	1.25
24	23.5	24.5	250	70	0.05	16.8	18.4	22.0	55	1.25

[1] $f = 1\text{ MHz}$; $V_R = 0\text{ V}$ [2] $t_p = 100\text{ }\mu\text{s}$; square wave; $T_j = 25\text{ }^\circ\text{C}$ prior to surge

Table 9. Characteristics per type; BZB84-B27 to BZB84-B75

$T_j = 25\text{ °C}$ unless otherwise specified.

BZB84-Bxxx	Working voltage V_Z (V)		Differential resistance r_{dif} (Ω)		Reverse current I_R (μ A)		Temperature coefficient S_Z (mV/K)		Diode capacitance C_d (pF) ^[1]	Non-repetitive peak reverse current I_{ZSM} (A) ^[2]
	$I_Z = 2\text{ mA}$		$I_Z = 0.5\text{ mA}$	$I_Z = 2\text{ mA}$	Max	V_R (V)	$I_Z = 2\text{ mA}$			
	Min	Max	Max	Max			Min	Max	Max	Max
27	26.5	27.5	300	80	0.05	18.9	21.4	25.3	50	1.00
30	29.4	30.6	300	80	0.05	21.0	24.4	29.4	50	1.00
33	32.3	33.7	325	80	0.05	23.1	27.4	33.4	45	0.90
36	35.3	36.7	350	90	0.05	25.2	30.4	37.4	45	0.80
39	38.2	39.8	350	130	0.05	27.3	33.4	41.2	45	0.70
43	42.1	43.9	375	150	0.05	30.1	37.6	46.6	40	0.60
47	46.1	47.9	375	170	0.05	32.9	42.0	51.8	40	0.50
51	50.0	52.0	400	180	0.05	35.7	46.6	57.2	40	0.40
56	54.9	57.1	425	200	0.05	39.2	52.2	63.8	40	0.30
62	60.8	63.2	450	215	0.05	43.4	58.8	71.6	35	0.30
68	66.6	69.4	475	240	0.05	47.6	65.6	79.8	35	0.25
75	73.5	76.5	500	255	0.05	52.5	73.4	88.6	35	0.20

[1] $f = 1\text{ MHz}$; $V_R = 0\text{ V}$

[2] $t_p = 100\text{ }\mu$ s; square wave; $T_j = 25\text{ °C}$ prior to surge

Table 10. Characteristics per type; BZB84-C2V4 to BZB84-C24

 $T_j = 25\text{ }^\circ\text{C}$ unless otherwise specified.

BZB84-Cxxx	Working voltage V_Z (V)		Differential resistance r_{dif} (Ω)		Reverse current I_R (μA)		Temperature coefficient S_Z (mV/K)		Diode capacitance C_d (pF) ^[1]	Non-repetitive peak reverse current I_{ZSM} (A) ^[2]
	$I_Z = 5\text{ mA}$		$I_Z = 1\text{ mA}$	$I_Z = 5\text{ mA}$	Max	V_R (V)	$I_Z = 5\text{ mA}$			
	Min	Max	Max	Max			Min	Max	Max	Max
2V4	2.2	2.6	600	100	50	1	-3.5	0	450	6.0
2V7	2.5	2.9	600	100	20	1	-3.5	0	450	6.0
3V0	2.8	3.2	600	95	10	1	-3.5	0	450	6.0
3V3	3.1	3.5	600	95	5	1	-3.5	0	450	6.0
3V6	3.4	3.8	600	90	5	1	-3.5	0	450	6.0
3V9	3.7	4.1	600	90	3	1	-3.5	0	450	6.0
4V3	4.0	4.6	600	90	3	1	-3.5	0	450	6.0
4V7	4.4	5.0	500	80	3	2	-3.5	0.2	300	6.0
5V1	4.8	5.4	480	60	2	2	-2.7	1.2	300	6.0
5V6	5.2	6.0	400	40	1	2	-2.0	2.5	300	6.0
6V2	5.8	6.6	150	10	3	4	0.4	3.7	200	6.0
6V8	6.4	7.2	80	15	2	4	1.2	4.5	200	6.0
7V5	7.0	7.9	80	15	1	5	2.5	5.3	150	4.0
8V2	7.7	8.7	80	15	0.70	5	3.2	6.2	150	4.0
9V1	8.5	9.6	100	15	0.50	6	3.8	7.0	150	3.0
10	9.4	10.6	150	20	0.20	7	4.5	8.0	90	3.0
11	10.4	11.6	150	20	0.10	8	5.4	9.0	85	2.5
12	11.4	12.7	150	25	0.10	8	6.0	10.0	85	2.5
13	12.4	14.1	170	30	0.10	8	7.0	11.0	80	2.5
15	13.8	15.6	200	30	0.05	10.5	9.2	13.0	75	2.0
16	15.3	17.1	200	40	0.05	11.2	10.4	14.0	75	1.5
18	16.8	19.1	225	45	0.05	12.6	12.4	16.0	70	1.5
20	18.8	21.2	225	55	0.05	14.0	14.4	18.0	60	1.5
22	20.8	23.3	250	55	0.05	15.4	16.4	20.0	60	1.25
24	22.8	25.6	250	70	0.05	16.8	18.4	22.0	55	1.25

[1] $f = 1\text{ MHz}$; $V_R = 0\text{ V}$ [2] $t_p = 100\text{ }\mu\text{s}$; square wave; $T_j = 25\text{ }^\circ\text{C}$ prior to surge

Table 11. Characteristics per type; BZB84-C27 to BZB84-C75

$T_j = 25\text{ }^\circ\text{C}$ unless otherwise specified.

BZB84-Cxxx	Working voltage V_Z (V)		Differential resistance r_{dif} (Ω)		Reverse current I_R (μA)		Temperature coefficient S_Z (mV/K)		Diode capacitance C_d (pF) ^[1]	Non-repetitive peak reverse current I_{ZSM} (A) ^[2]
	$I_Z = 2\text{ mA}$		$I_Z = 0.5\text{ mA}$	$I_Z = 2\text{ mA}$	V_R (V)	$I_Z = 2\text{ mA}$				
	Min	Max	Max	Max		Max	Min	Max	Max	Max
27	25.1	28.9	300	80	0.05	18.9	21.4	25.3	50	1.00
30	28.0	32.0	300	80	0.05	21.0	24.4	29.4	50	1.00
33	31.0	35.0	325	80	0.05	23.1	27.4	33.4	45	0.90
36	34.0	38.0	350	90	0.05	25.2	30.4	37.4	45	0.80
39	37.0	41.0	350	130	0.05	27.3	33.4	41.2	45	0.70
43	40.0	46.0	375	150	0.05	30.1	37.6	46.6	40	0.60
47	44.0	50.0	375	170	0.05	32.9	42.0	51.8	40	0.50
51	48.0	54.0	400	180	0.05	35.7	46.6	57.2	40	0.40
56	52.0	60.0	425	200	0.05	39.2	52.2	63.8	40	0.30
62	58.0	66.0	450	215	0.05	43.4	58.8	71.6	35	0.30
68	64.0	72.0	475	240	0.05	47.6	65.6	79.8	35	0.25
75	70.0	79.0	500	255	0.05	52.5	73.4	88.6	35	0.20

[1] $f = 1\text{ MHz}$; $V_R = 0\text{ V}$

[2] $t_p = 100\text{ }\mu\text{s}$; square wave; $T_j = 25\text{ }^\circ\text{C}$ prior to surge

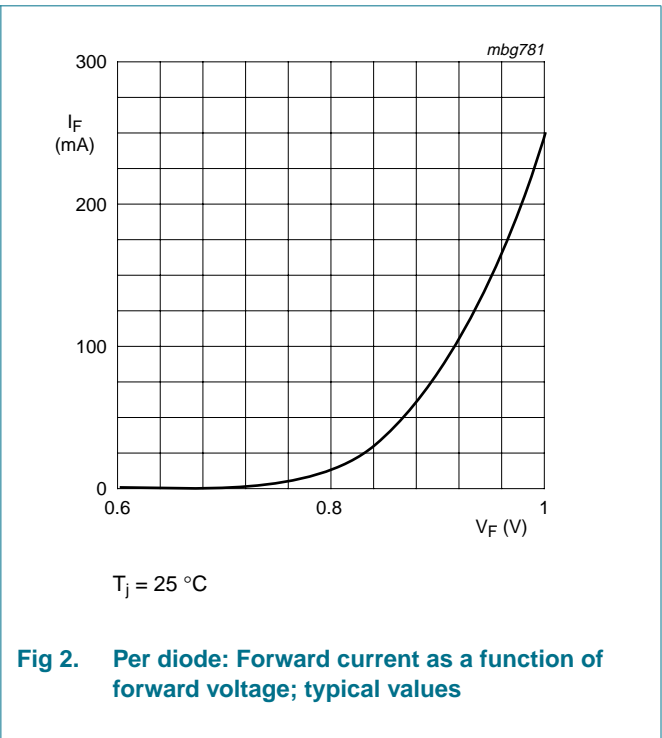
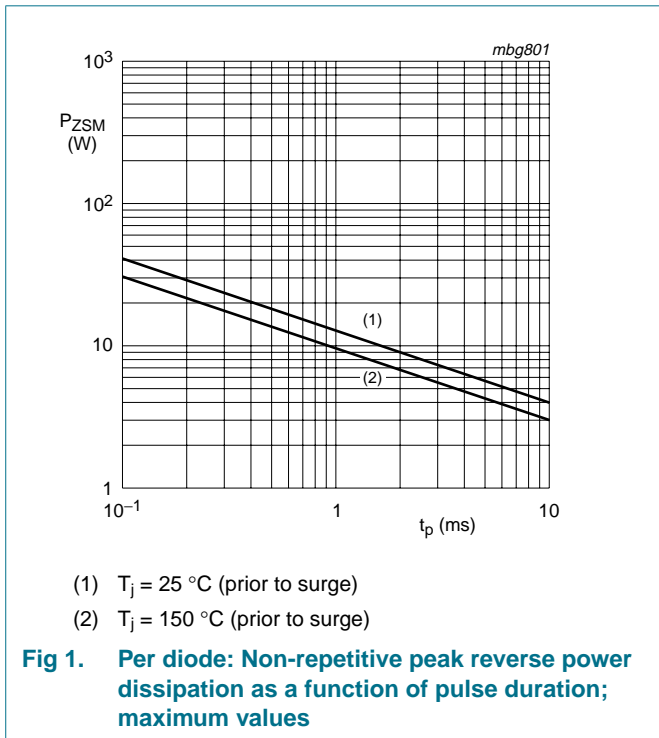



$T_j = 25\text{ }^\circ\text{C to }150\text{ }^\circ\text{C}$
BZB84-B/C2V4 to BZB84-B/C4V3

Fig 3. Per diode: Temperature coefficient as a function of working current; typical values



$T_j = 25\text{ }^\circ\text{C to }150\text{ }^\circ\text{C}$
BZB84-B/C4V7 to BZB84-B/C12

Fig 4. Per diode: Temperature coefficient as a function of working current; typical values



$T_j = 25\text{ }^\circ\text{C}$
BZB84-B/C2V7 to BZB84-B/C8V2

Fig 5. Per diode: Working current as a function of working voltage; typical values



$T_j = 25\text{ }^\circ\text{C}$
BZB84-B/C10 to BZB84-B/C36

Fig 6. Per diode: Working current as a function of working voltage; typical values

8. Test information

8.1 Quality information

This product has been qualified in accordance with the Automotive Electronics Council (AEC) standard *Q101 - Stress test qualification for discrete semiconductors*, and is suitable for use in automotive applications.

9. Package outline



10. Packing information

Table 12. Packing methods

The indicated -xxx are the last three digits of the 12NC ordering code.^[1]

Type number	Package	Description	Packing quantity	
			3000	10000
BZB84-B2V4 to BZB84-C75 ^[2]	SOT23	4 mm pitch, 8 mm tape and reel	-215	-235

[1] For further information and the availability of packing methods, see [Section 14](#).

[2] The series consists of 74 types with nominal working voltages from 2.4 V to 75 V.

11. Soldering

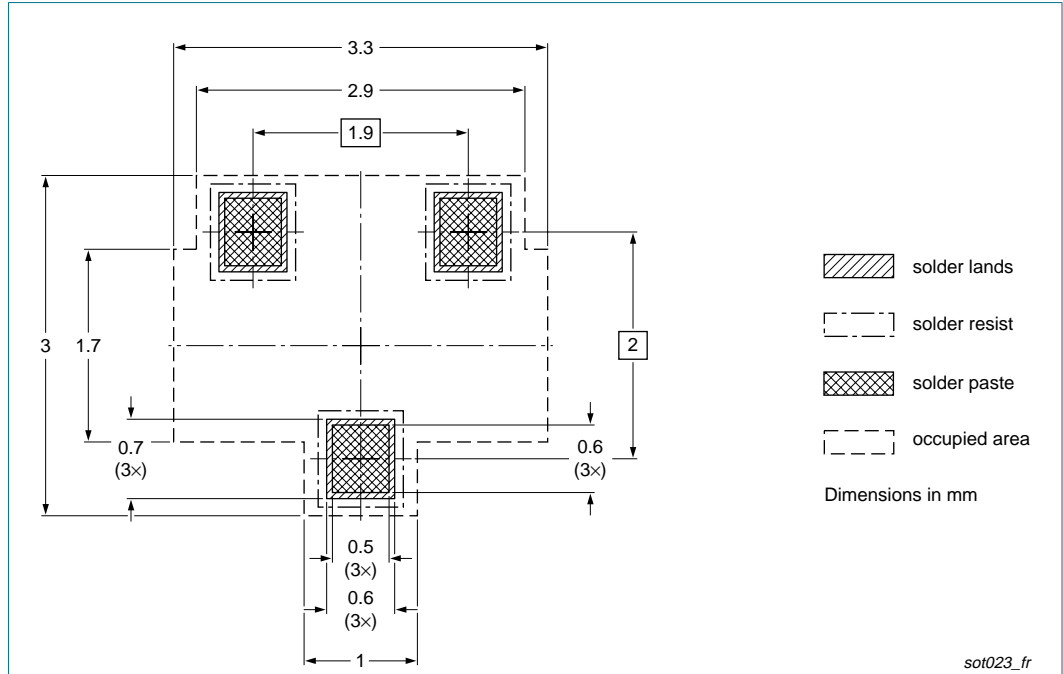

Fig 8. Reflow soldering footprint SOT23 (TO-236AB)



Fig 9. Wave soldering footprint SOT23 (TO-236AB)

12. Revision history

Table 13. Revision history

Document ID	Release date	Data sheet status	Change notice	Supersedes
BZB84_SER_3	20090609	Product data sheet	-	BZB84_SER_2
Modifications:		<ul style="list-style-type: none">• Table 5 “Limiting values”: P_{tot} maximum value amended• Table 6: R_{th} maximum values amended• Section 13 “Legal information”: updated		
BZB84_SER_2	20090223	Product data sheet	-	BZB84_SER_1
BZB84_SER_1	20080514	Product data sheet	-	-

13. Legal information

13.1 Data sheet status

Document status ^{[1][2]}	Product status ^[3]	Definition
Objective [short] data sheet	Development	This document contains data from the objective specification for product development.
Preliminary [short] data sheet	Qualification	This document contains data from the preliminary specification.
Product [short] data sheet	Production	This document contains the product specification.

[1] Please consult the most recently issued document before initiating or completing a design.

[2] The term 'short data sheet' is explained in section "Definitions".

[3] The product status of device(s) described in this document may have changed since this document was published and may differ in case of multiple devices. The latest product status information is available on the Internet at URL <http://www.nxp.com>.

13.2 Definitions

Draft — The document is a draft version only. The content is still under internal review and subject to formal approval, which may result in modifications or additions. NXP Semiconductors does not give any representations or warranties as to the accuracy or completeness of information included herein and shall have no liability for the consequences of use of such information.

Short data sheet — A short data sheet is an extract from a full data sheet with the same product type number(s) and title. A short data sheet is intended for quick reference only and should not be relied upon to contain detailed and full information. For detailed and full information see the relevant full data sheet, which is available on request via the local NXP Semiconductors sales office. In case of any inconsistency or conflict with the short data sheet, the full data sheet shall prevail.

13.3 Disclaimers

General — Information in this document is believed to be accurate and reliable. However, NXP Semiconductors does not give any representations or warranties, expressed or implied, as to the accuracy or completeness of such information and shall have no liability for the consequences of use of such information.

Right to make changes — NXP Semiconductors reserves the right to make changes to information published in this document, including without limitation specifications and product descriptions, at any time and without notice. This document supersedes and replaces all information supplied prior to the publication hereof.

Suitability for use — NXP Semiconductors products are not designed, authorized or warranted to be suitable for use in medical, military, aircraft, space or life support equipment, nor in applications where failure or malfunction of an NXP Semiconductors product can reasonably be expected to result in personal injury, death or severe property or environmental

damage. NXP Semiconductors accepts no liability for inclusion and/or use of NXP Semiconductors products in such equipment or applications and therefore such inclusion and/or use is at the customer's own risk.

Applications — Applications that are described herein for any of these products are for illustrative purposes only. NXP Semiconductors makes no representation or warranty that such applications will be suitable for the specified use without further testing or modification.

Limiting values — Stress above one or more limiting values (as defined in the Absolute Maximum Ratings System of IEC 60134) may cause permanent damage to the device. Limiting values are stress ratings only and operation of the device at these or any other conditions above those given in the Characteristics sections of this document is not implied. Exposure to limiting values for extended periods may affect device reliability.

Terms and conditions of sale — NXP Semiconductors products are sold subject to the general terms and conditions of commercial sale, as published at <http://www.nxp.com/profile/terms>, including those pertaining to warranty, intellectual property rights infringement and limitation of liability, unless explicitly otherwise agreed to in writing by NXP Semiconductors. In case of any inconsistency or conflict between information in this document and such terms and conditions, the latter will prevail.

No offer to sell or license — Nothing in this document may be interpreted or construed as an offer to sell products that is open for acceptance or the grant, conveyance or implication of any license under any copyrights, patents or other industrial or intellectual property rights.

Export control — This document as well as the item(s) described herein may be subject to export control regulations. Export might require a prior authorization from national authorities.

Quick reference data — The Quick reference data is an extract of the product data given in the Limiting values and Characteristics sections of this document, and as such is not complete, exhaustive or legally binding.

13.4 Trademarks

Notice: All referenced brands, product names, service names and trademarks are the property of their respective owners.

14. Contact information

For more information, please visit: <http://www.nxp.com>

For sales office addresses, please send an email to: salesaddresses@nxp.com

15. Contents

1 Product profile 1

1.1 General description 1

1.2 Features 1

1.3 Applications 1

1.4 Quick reference data 1

2 Pinning information 2

3 Ordering information 2

4 Marking 2

5 Limiting values 3

6 Thermal characteristics 4

7 Characteristics 4

8 Test information 10

8.1 Quality information 10

9 Package outline 10

10 Packing information 10

11 Soldering 11

12 Revision history 12

13 Legal information 13

13.1 Data sheet status 13

13.2 Definitions 13

13.3 Disclaimers 13

13.4 Trademarks 13

14 Contact information 13

15 Contents 14

Please be aware that important notices concerning this document and the product(s) described herein, have been included in section 'Legal information'.



© NXP B.V. 2009.

All rights reserved.

For more information, please visit: <http://www.nxp.com>



For sales office addresses, please send an email to: salesaddresses@nxp.com

Date of release: 9 June 2009

Document identifier: BZB84_SER_3

Looking for pricing, stock, or lifecycle information?

Click below to explore more details on WIN SOURCE:

-  [View BZB84-C15,215 on WIN SOURCE](#)
-  [Nexperia USA Inc. Information](#)

Optimize Your Supply Chain with WIN SOURCE Solutions

-  Global Sourcing Solution
-  Obsolete Management
-  Cost Control Management
-  Shortage Management
-  Alternative Solution
-  Excess Inventory Management