

CMPD3003
 CMPD3003A
 CMPD3003C
 CMPD3003S

**SURFACE MOUNT
 LOW LEAKAGE
 SILICON SWITCHING DIODE**



www.centrasemi.com

DESCRIPTION:

The CENTRAL SEMICONDUCTOR CMPD3003 series types are silicon switching diodes manufactured by the epitaxial planar process, designed for switching applications requiring an extremely low leakage diode.



SOT-23 CASE

The following configurations are available:

CMPD3003 SINGLE
 CMPD3003A DUAL, COMMON ANODE
 CMPD3003C DUAL, COMMON CATHODE
 CMPD3003S DUAL, IN SERIES

MARKING CODE: LLO

MARKING CODE: LLA

MARKING CODE: LLC

MARKING CODE: LLS

MAXIMUM RATINGS: ($T_A=25^\circ\text{C}$)

Continuous Reverse Voltage
 Average Forward Current
 Continuous Forward Current
 Peak Repetitive Forward Current
 Peak Forward Surge Current, $t_p=1.0\mu\text{s}$
 Peak Forward Surge Current, $t_p=1.0\text{s}$
 Power Dissipation
 Operating and Storage Junction Temperature
 Thermal Resistance

SYMBOL

V_R 180
 I_O 200
 I_F 600
 I_{FRM} 700
 I_{FSM} 2.0
 I_{FSM} 1.0
 P_D 350
 T_J, T_{stg} -65 to +150
 θ_{JA} 357

UNITS

V
 mA
 mA
 mA
 A
 A
 mW
 $^\circ\text{C}$
 $^\circ\text{C/W}$

ELECTRICAL CHARACTERISTICS PER DIODE: ($T_A=25^\circ\text{C}$ unless otherwise noted)

SYMBOL	TEST CONDITIONS	MIN	MAX	UNITS
I_R	$V_R=125\text{V}$		1.0	nA
I_R	$V_R=125\text{V}, T_A=150^\circ\text{C}$		3.0	μA
I_R	$V_R=180\text{V}$		10	nA
I_R	$V_R=180\text{V}, T_A=150^\circ\text{C}$		5.0	μA
BV_R	$I_R=5.0\mu\text{A}$	200		V
V_F	$I_F=1.0\text{mA}$	0.62	0.72	V
V_F	$I_F=10\text{mA}$	0.72	0.83	V
V_F	$I_F=50\text{mA}$	0.80	0.89	V
V_F	$I_F=100\text{mA}$	0.83	0.93	V
V_F	$I_F=200\text{mA}$	0.87	1.10	V
V_F	$I_F=300\text{mA}$	0.90	1.15	V
C_T	$V_R=0, f=1.0\text{MHz}$		4.0	pF

R4 (25-January 2010)

CMPD3003
 CMPD3003A
 CMPD3003C
 CMPD3003S



**SURFACE MOUNT
 LOW LEAKAGE
 SILICON SWITCHING DIODE**

SOT-23 CASE - MECHANICAL OUTLINE

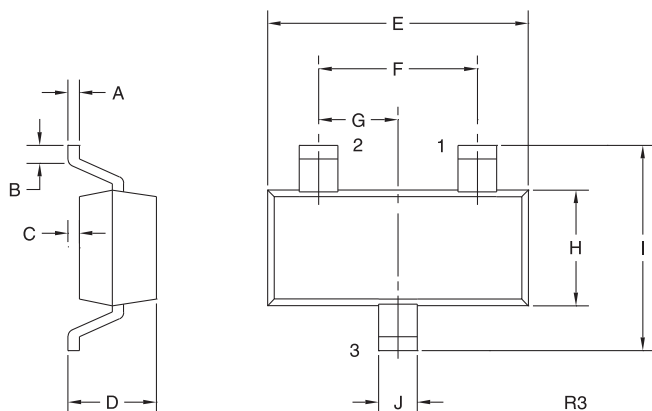

SYMBOL	INCHES		MILLIMETERS	
	MIN	MAX	MIN	MAX
A	0.003	0.007	0.08	0.18
B	0.006	-	0.15	-
C	-	0.005	-	0.13
D	0.035	0.043	0.89	1.09
E	0.110	0.120	2.80	3.05
F	0.075		1.90	
G	0.037		0.95	
H	0.047	0.055	1.19	1.40
I	0.083	0.098	2.10	2.49
J	0.014	0.020	0.35	0.50

SOT-23 (REV: R3)

PIN CONFIGURATIONS

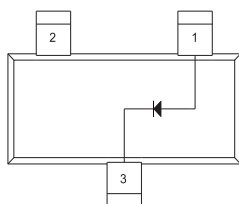

CMPD3003

LEAD CODE:

- 1) Anode
- 2) No Connection
- 3) Cathode

MARKING CODE: LLO

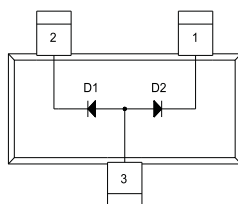

CMPD3003A

LEAD CODE:

- 1) Cathode D2
- 2) Cathode D1
- 3) Anode D1, D2

MARKING CODE: LLA

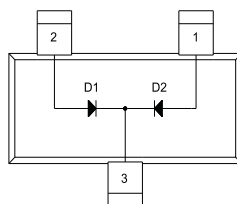

CMPD3003C

LEAD CODE:

- 1) Anode D2
- 2) Anode D1
- 3) Cathode D1, D2

MARKING CODE: LLC

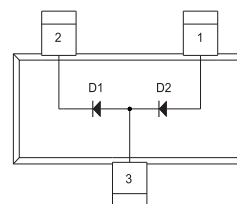

CMPD3003S

LEAD CODE:

- 1) Anode D2
- 2) Cathode D1
- 3) Anode D1, Cathode D2

MARKING CODE: LLS

R4 (25-January 2010)

OUTSTANDING SUPPORT AND SUPERIOR SERVICES



PRODUCT SUPPORT

Central's operations team provides the highest level of support to insure product is delivered on-time.

- Supply management (Customer portals)
- Inventory bonding
- Consolidated shipping options
- Custom bar coding for shipments
- Custom product packing

DESIGNER SUPPORT/SERVICES

Central's applications engineering team is ready to discuss your design challenges. Just ask.

- Free quick ship samples (2nd day air)
- Online technical data and parametric search
- SPICE models
- Custom electrical curves
- Environmental regulation compliance
- Customer specific screening
- Up-screening capabilities
- Special wafer diffusions
- PbSn plating options
- Package details
- Application notes
- Application and design sample kits
- Custom product and package development

REQUESTING PRODUCT PLATING

1. If requesting Tin/Lead plated devices, add the suffix " TIN/LEAD" to the part number when ordering (example: 2N2222A TIN/LEAD).
2. If requesting Lead (Pb) Free plated devices, add the suffix " PBFREE" to the part number when ordering (example: 2N2222A PBFREE).

CONTACT US

Corporate Headquarters & Customer Support Team

Central Semiconductor Corp.
145 Adams Avenue
Hauppauge, NY 11788 USA
Main Tel: (631) 435-1110
Main Fax: (631) 435-1824
Support Team Fax: (631) 435-3388
www.centrasemi.com



Worldwide Field Representatives:
www.centrasemi.com/wwreps

Worldwide Distributors:
www.centrasemi.com/wwdistributors

For the latest version of Central Semiconductor's **LIMITATIONS AND DAMAGES DISCLAIMER**, which is part of Central's Standard Terms and Conditions of sale, visit: www.centrasemi.com/terms

Looking for pricing, stock, or lifecycle information?

Click below to explore more details on WIN SOURCE:

-  [View CMPD3003C TR on WIN SOURCE](#)
-  [Central Semiconductor Corp Information](#)

Optimize Your Supply Chain with WIN SOURCE Solutions

-  Global Sourcing Solution
-  Obsolete Management
-  Cost Control Management
-  Shortage Management
-  Alternative Solution
-  Excess Inventory Management