

FEATURES

- SUITABLE FOR USE AS RF AMPLIFIER IN UHF TUNER
- LOW C_{rss} : 0.02 pF (TYP)
- HIGH GPS: 20 dB (TYP) AT 900 MHz
- LOW NF: 1.1 dB TYP AT 900 MHz
- $L_{G1} = 1.0 \mu\text{m}$, $L_{G2} = 1.5 \mu\text{m}$, $W_G = 400 \mu\text{m}$
- ION IMPLANTATION
- AVAILABLE IN TAPE & REEL OR BULK

POWER GAIN AND NOISE FIGURE vs. DRAIN TO SOURCE VOLTAGE

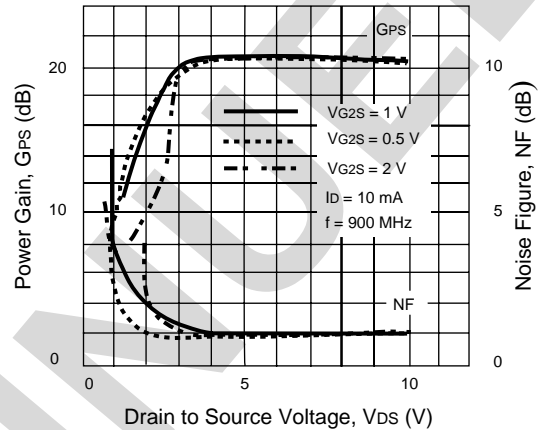

DESCRIPTION

The NE251 is a dual gate GaAs FET designed to provide flexibility in its application as a mixer, AGC amplifier, or low noise amplifier. As an example, by shorting the second gate to the source, higher gain can be realized than with single gate MESFETs. This device is available in a mini-mold (surface mount) package.

ELECTRICAL CHARACTERISTICS (T_A = 25°C)

PART NUMBER PACKAGE OUTLINE			NE25139 39		
SYMBOL	PARAMETERS AND CONDITIONS	UNITS	MIN	TYP	MAX
NF	Noise Figure at V _{ds} = 5 V, V _{G2S} = 1 V, I _D = 10 mA, f = 900 MHz	dB		1.1	2.5
GPS	Power Gain at V _{ds} = 5 V, V _{G2S} = 1 V, I _D = 10 mA, f = 900 MHz	dB	16	20	
BV _{dsx}	Drain to Source Breakdown Voltage at V _{G1S} = -4 V, V _{G2S} = 0, I _D = 10 μA	V	13		
I _{DSS}	Saturated Drain Current at V _{ds} = 5 V, V _{G2S} = 0 V, V _{G1S} = 0 V	mA	5	20	40
V _{G1S} (OFF)	Gate 1 to Source Cutoff Voltage at V _{ds} = 5 V, V _{G2S} = 0 V, I _D = 100 μA	V	-3.5		
V _{G2S} (OFF)	Gate 2 to Source Cutoff Voltage at V _{ds} = 5 V, V _{G1S} = 0 V, I _D = 100 μA	V	-3.5		
I _{G1SS}	Gate 1 Reverse Current at V _{ds} = 0, V _{G1S} = -4V, V _{G2S} = 0	μA			10
I _{G2SS}	Gate 2 Reverse Current at V _{ds} = 0, V _{G2S} = -4V, V _{G1S} = 0	μA			10
Y _{FS}	Forward Transfer Admittance at V _{ds} = 5 V, V _{G2S} = 1 V, I _D = 10 mA, f = 1.0 kHz	mS	18	25	35
C _{ISS}	Input Capacitance at V _{ds} = 5 V, V _{G2S} = 1 V, I _D = 10 mA, f = 1 MHz	pF	0.5	1.0	1.5
C _{RSS}	Reverse Transfer Capacitance at V _{ds} = 5 V, V _{G2S} = 1 V, I _D = 10 mA, f = 1 MHz	pF		0.02	0.03

ABSOLUTE MAXIMUM RATINGS¹ ($T_A = 25^\circ\text{C}$)

SYMBOLS	PARAMETERS	UNITS	RATINGS
V _{DS}	Drain to Source Voltage	V	13
V _{G1S}	Gate 1 to Source Voltage	V	-4.5
V _{G2S}	Gate 2 to Source Voltage	V	-4.5
I _D	Drain Current	mA	I _{DSS}
P _T	Total Power Dissipation	mW	200
T _{CH}	Channel Temperature	°C	125
T _{STG}	Storage Temperature	°C	-55 to +125

Note:

1. Operation in excess of anyone of these parameters may result in permanent damage.

TYPICAL NOISE PARAMETERS ($T_A = 25^\circ\text{C}$)

(V_{DS} = 5 V, V_{G2S} = 0 V, I_{DS} = 10 mA)

FREQ. (GHz)	NF _{OPT} (dB)	G _A (dB)	Γ _{OPT}		R _n /50
			MAG	ANG	
0.5	0.9	18.5	0.9	18	1.9
0.9	1.2	16.0	0.82	28	1.2
1.5	1.5	14.6	0.71	45	0.9
2.0	1.9	12.5	0.55	75	0.67
3.0	2.5	11.0	0.34	116	0.5
4.0	3.3	9.5	0.25	154	0.4

TYPICAL PERFORMANCE CURVES ($T_A = 25^\circ\text{C}$)

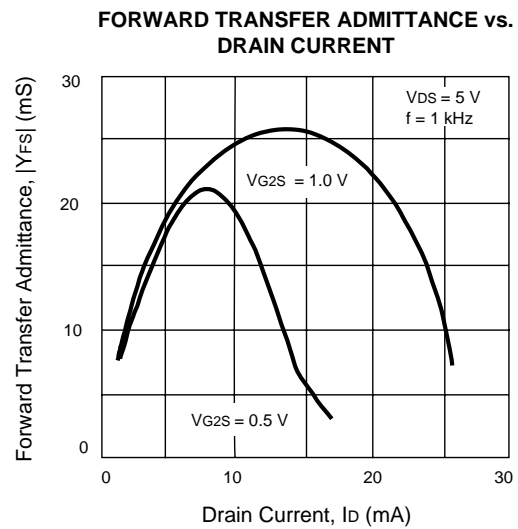
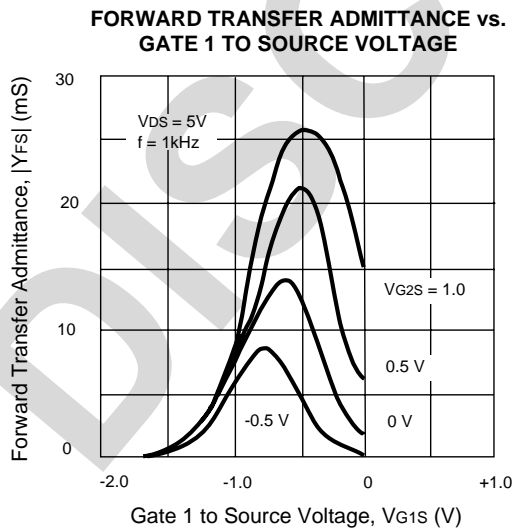
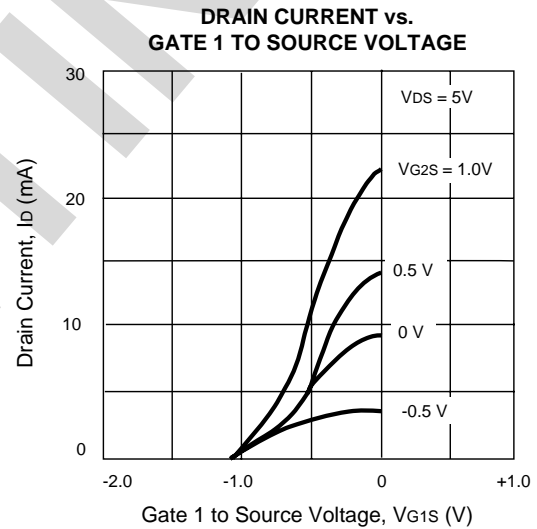
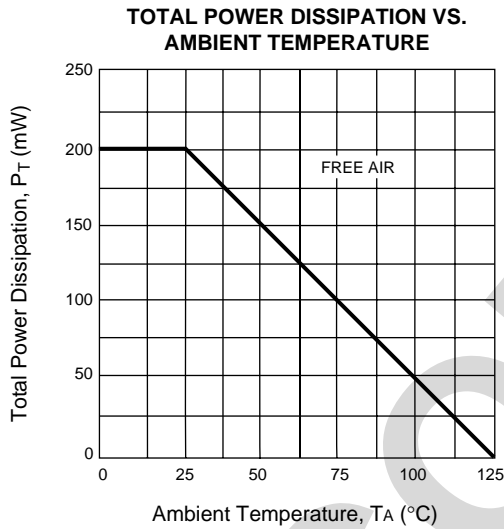

TYPICAL PERFORMANCE CURVES ($T_A = 25^\circ\text{C}$)

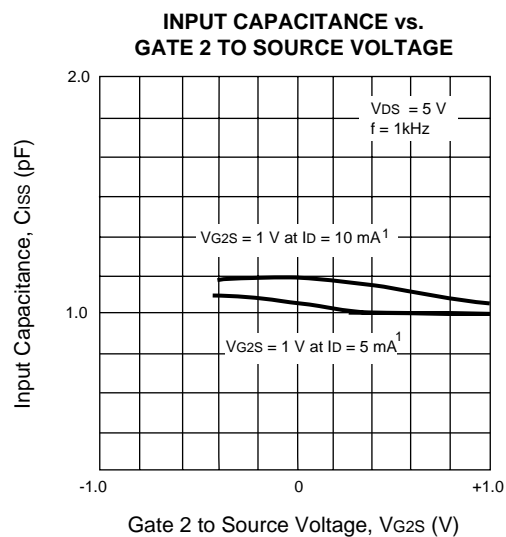

Note:

1. Initial bias conditions. V_{G1S} set to obtain specified drain current.

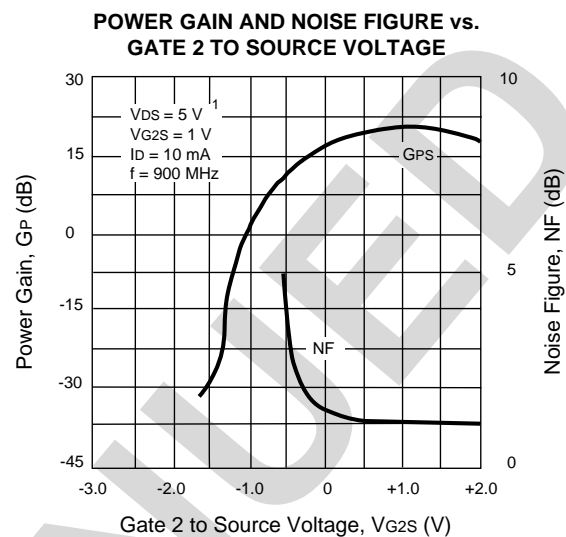

Note:

1. Initial bias conditions. V_{G1S} set to obtain specified drain current.

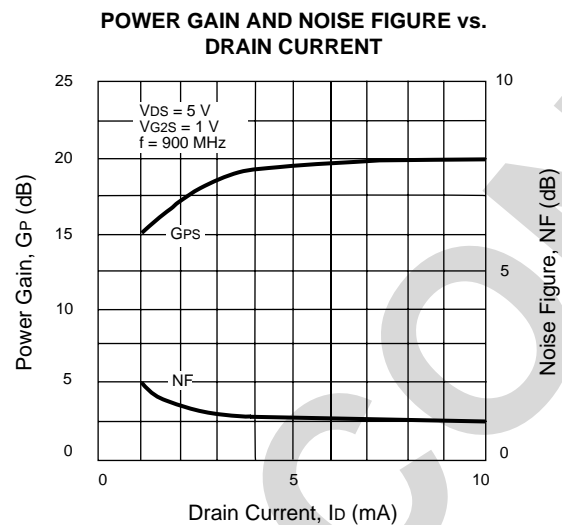

NONLINEAR MODEL

UNITS FOR MODEL PARAMETERS

Parameter	Units
time	seconds
capacitance	farads
inductance	henries
resistance	ohms
voltage	volts
current	amps

FET NONLINEAR MODEL PARAMETERS⁽¹⁾

Parameters	FET1	FET2	Parameters	FET1	FET2
UGW	100e-6	100e-6	IDSOC	0.07	0.07
NGF	4	4	RDB	1.0e9	1.0e9
IS	8.78e-10	8.78e-10	CBS	0.16e-12	0.16e-12
N	1.33	1.33	GDBM	0.005	0.005
RG	0	0	KDB	11.1	11.1
RD	0	0	VDSM	7.1e-11	7.1e-11
RS	0	0	GMMAXAC	0.0475	0.0875
RIS	0	0	GAMMAAC	0.0107	0.0051
RID	0	0	KAPAAC	0.0001	0.0052
TAU	5.17e-12	5.17e-12	PEFFAC	44.9	44.9
CDSO	1.19e-13	1.19e-13	VTOAC	-1.584	-1.545
C11O	6.1e-13	6.1e-13	VTSOAC	-100	-100
C11TH	1.6e-13	1.6e-13	VDELTAAC	0.062	0.062
VINFL	-1.1	-1.1	GMMAX	0.0554	0.0304
DELTS	1.82	1.82	GAMMA	0.006	0.005
DELTD	0.682	0.682	KAPA	0.046	0.0005
LAMBDA	0.036	0.036	PEFF	1.636	1.636
C11DELTA	0	0	VTO	-1.57	-1.5
C12O	0	0	VTSO	-100	-10
C12SAT	6.81e-14	6.81e-14	VDELTA	0.135	0.1
CGDSAT	6.81e-14	6.81e-14	VCH	1	1
KBK	0.03	0.03	VSAT	1.119	1.119
VBR	6.5	6.5	VGO	-0.654	-0.0035
NBR	2	2	VDSO	3	10

(1) Libra EEFET3 Model

NONLINEAR MODEL

SCHEMATIC

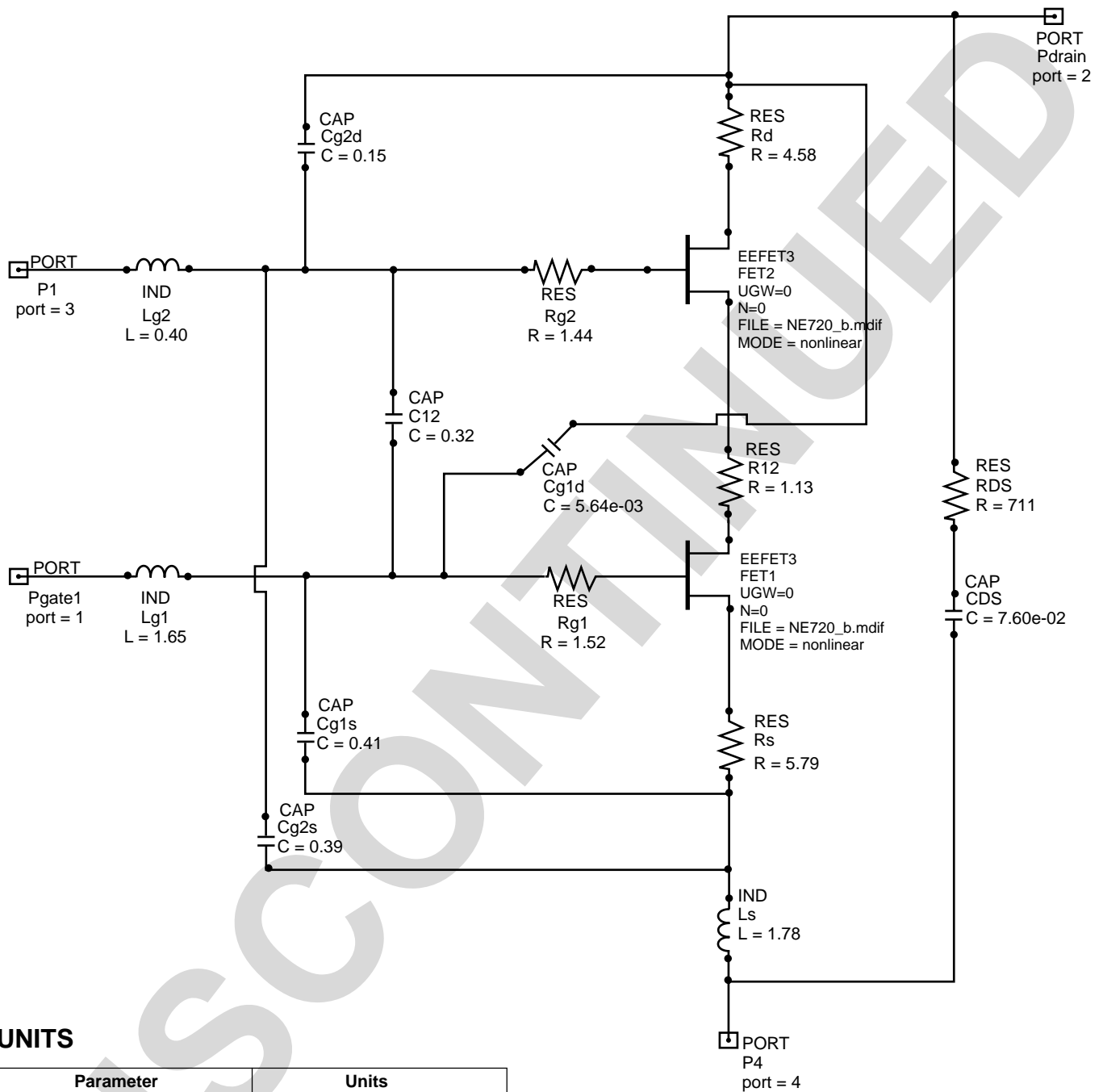

UNITS

Parameter	Units
capacitance	picofarads
inductance	nanohenries
resistance	ohms

NOTES:

1. This UGW value scales the model parameters on page 1.
2. This N value is the number of gate fingers and scales the model parameters on page 1.

MODEL RANGE

Frequency: 0.1 to 4 GHz
 Bias: $V_{DS} = 5\text{ V}$, $V_{g1s} = -0.785\text{ V}$, $V_{g2s} = 0\text{ V}$, $I_D = 10\text{ mA}$

TYPICAL COMMON SOURCE SCATTERING PARAMETERS (TA = 25°C)

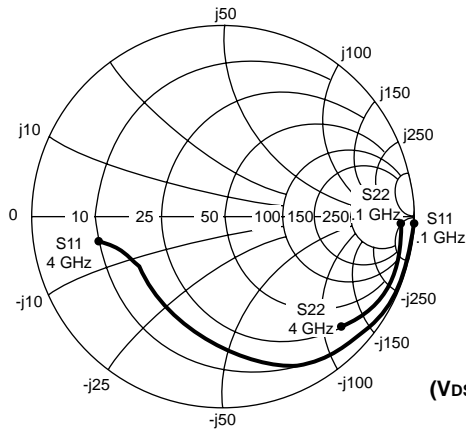

Coordinates in Ohms
Frequency in GHz
(Vds = 5 V, Vgs = 0 V, Ids = 10 mA)

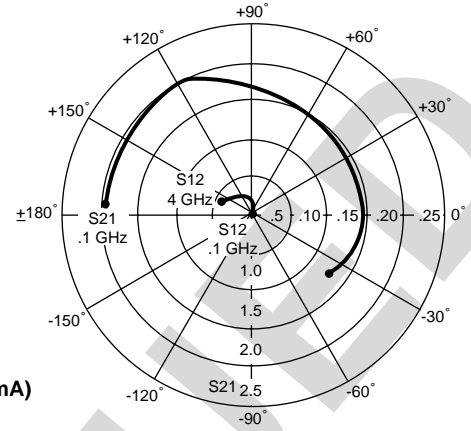

NE25139

Vds = 5 V, Vgs = 0 V, Ids = 10 mA

FREQUENCY (GHz)	S11		S21		S12		S22		K	S21 (dB)	MAG ¹ (dB)
	MAG	ANG	MAG	ANG	MAG	ANG	MAG	ANG			
0.1	1.0	-4	1.96	174	0.001	87	0.96	-1	0.47	5.8	32.9
0.2	1.0	-8	1.92	169	0.001	85	0.96	-2	0.51	5.7	32.8
0.4	0.99	-15	1.91	158	0.001	82	0.95	-3	0.70	5.6	32.8
0.6	0.97	-23	1.90	148	0.002	81	0.94	-3	1.14	5.6	27.5
0.9	0.94	-35	1.90	132	0.004	80	0.94	-4	1.18	5.6	24.2
1.0	0.92	-39	1.90	126	0.004	79	0.94	-5	1.49	5.6	22.6
1.5	0.82	-61	1.88	99	0.006	78	0.94	-6	2.03	5.5	19.2
2.0	0.69	-86	1.52	71	0.008	95	0.95	-9	2.21	3.6	16.6
2.5	0.60	-110	1.41	45	0.012	118	0.96	-12	1.34	3.0	17.2
3.0	0.51	-131	1.39	19	0.023	153	0.97	-18	0.32	2.9	17.8
3.5	0.51	-147	1.37	-6	0.039	162	0.97	-27	0.04	2.1	15.1
4.0	0.63	-167	1.20	-47	0.042	157	0.96	-42	0.07	1.6	14.6

Note:

1. Gain Calculations:

$$MAG = \frac{|S21|}{|S12|} \cdot (K \pm \sqrt{K^2 - 1})$$

When $K \leq 1$, MAG is undefined and MSG values are used. $MSG = \frac{|S21|}{|S12|}$, $K = \frac{1 + |\Delta|^2 - |S11|^2 - |S22|^2}{2 |S12 S21|}$, $\Delta = S11 S22 - S21 S12$

MAG = Maximum Available Gain

MSG = Maximum Stable Gain

TYPICAL COMMON SOURCE SCATTERING PARAMETERS (TA = 25°C)

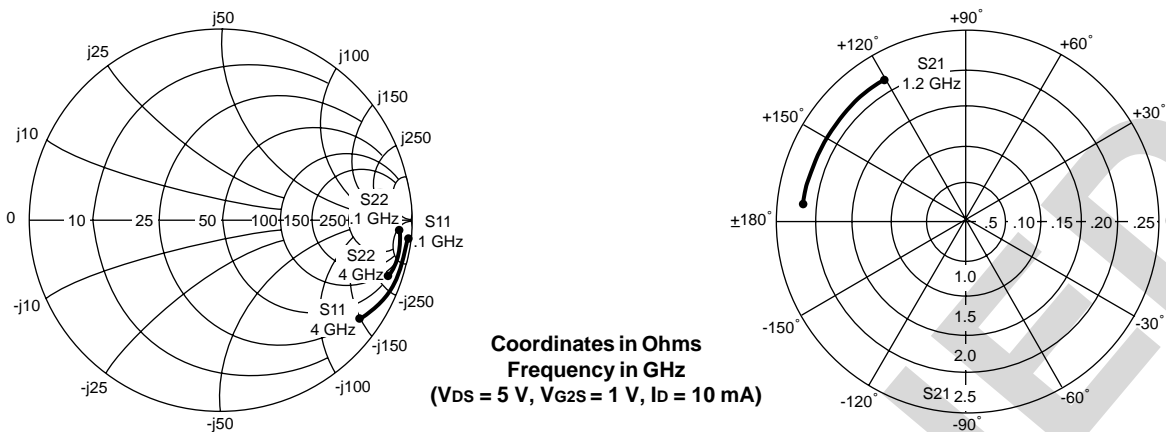

NE25139
Vds = 5 V, Vg2s = 1 V, Id = 10 mA

FREQUENCY (GHz)	S11		S21		S12		S22		K	S21 (dB)	MAG ¹ (dB)
	MAG	ANG	MAG	ANG	MAG	ANG	MAG	ANG			
0.1	.99	-3	2.36	177	.001	87	.97	-1	0.47	5.83	2.9
0.2	.99	-7	2.39	169	.001	85	.98	-3	0.51	5.7	32.8
0.3	.99	-9	2.31	164	.002	82	.98	-3	0.70	5.6	32.8
0.4	.98	-13	2.23	160	.002	82	.97	-6	1.14	5.6	27.5
0.5	.97	-16	2.42	158	.003	81	.99	-6	1.18	5.6	24.2
0.6	.97	-19	2.30	150	.003	81	.96	-8	1.49	5.6	22.6
0.7	.96	-22	2.33	146	.004	80	.99	-9	2.03	5.5	19.2
0.8	.95	-25	2.23	142	.005	79	.96	-9	2.21	3.6	16.6
0.9	.94	-29	2.45	137	.005	79	.99	-13	1.34	3.0	17.2
1.0	.92	-29	2.30	131	.006	78	.97	-11	0.32	2.9	17.8
1.1	.91	-35	2.35	126	.006	78	.98	-15	0.04	2.1	15.1
1.2	.88	-35	2.37	124	.006	78	.99	-13	0.07	1.6	14.6

Note:

1. Gain Calculations:

$$MAG = \frac{|S_{21}|}{|S_{12}|} (K \pm \sqrt{K^2 - 1})$$

When $K \leq 1$, MAG is undefined and MSG values are used. $MSG = \frac{|S_{21}|}{|S_{12}|}$, $K = \frac{1 + |\Delta|^2 - |S_{11}|^2 - |S_{22}|^2}{2 |S_{12} S_{21}|}$, $\Delta = S_{11} S_{22} - S_{21} S_{12}$

MAG = Maximum Available Gain, MSG = Maximum Stable Gain

OUTLINE DIMENSIONS (Units in mm)

PACKAGE OUTLINE 39
(SOT-143)

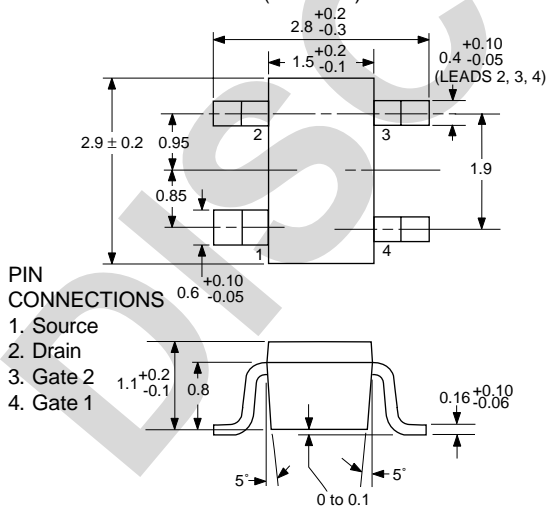

ORDERING INFORMATION

PART NUMBER	AVAILABILITY	Idss RANGE (mA)	MARKING
NE25139	Bulk up to 3K	5 - 40	
NE25139-T1	3K/Reel	5 - 40	
NE25139U71	Bulk up to 3K	5 - 15	U71
NE25139T1U71	3K/Reel	5 - 15	U71
NE25139U72	Bulk up to 3K	10 - 25	U72
NE25139T1U72	3K/Reel	10 - 25	U72
NE25139U73	Bulk up to 3K	20 - 35	U73
NE25139T1U73	3K/Reel	20 - 35	U73
NE25139U74	Bulk up to 3K	30 - 40	U74
NE25139T1U74	3K/Reel	30 - 40	U74

Note: All dimensions are typical unless otherwise specified.

EXCLUSIVE NORTH AMERICAN AGENT FOR **NEC** RF, MICROWAVE & OPTOELECTRONIC SEMICONDUCTORS

CEL CALIFORNIA EASTERN LABORATORIES • Headquarters • 4590 Patrick Henry Drive • Santa Clara, CA 95054-1817 • (408) 988-3500 • Telex 34-6393 • FAX (408) 988-0279
 24-Hour Fax-On-Demand: 800-390-3232 (U.S. and Canada only) • Internet: <http://WWW.CEL.COM>

DATA SUBJECT TO CHANGE WITHOUT NOTICE

Looking for pricing, stock, or lifecycle information?

Click below to explore more details on WIN SOURCE:

 [View NE25139-T1-U73 on WIN SOURCE](#)

 [CEL Information](#)

Optimize Your Supply Chain with WIN SOURCE Solutions

-  Global Sourcing Solution
-  Obsolete Management
-  Cost Control Management
-  Shortage Management
-  Alternative Solution
-  Excess Inventory Management