



**THE DATASHEET OF  
NTMFS4837NHT3G**



# NTMFS4837NH

## Power MOSFET

30 V, 75 A, Single N-Channel, SO-8 FL

### Features

- Low  $R_{DS(on)}$  to Minimize Conduction Losses
- Low Capacitance to Minimize Driver Losses
- Optimized Gate Charge to Minimize Switching Losses
- Low  $R_G$
- These are Pb-Free Devices\*

### Applications

- Refer to Application Note AND8195/D
- CPU Power Delivery
- DC-DC Converters and Low Side Switching

### MAXIMUM RATINGS ( $T_J = 25^\circ\text{C}$ unless otherwise stated)

Parameter	Symbol	Value	Unit
Drain-to-Source Voltage	$V_{DSS}$	30	V
Gate-to-Source Voltage	$V_{GS}$	$\pm 20$	V
Continuous Drain Current $R_{\theta JA}$ (Note 1)	$I_D$	$T_A = 25^\circ\text{C}$	16
		$T_A = 85^\circ\text{C}$	11.5
Power Dissipation $R_{\theta JA}$ (Note 1)	$P_D$	$T_A = 25^\circ\text{C}$	2.2
		$T_A = 85^\circ\text{C}$	1.15
Continuous Drain Current $R_{\theta JA} \leq 10$ s	$I_D$	$T_A = 25^\circ\text{C}$	26
		$T_A = 85^\circ\text{C}$	18.8
Power Dissipation $R_{\theta JA} \leq 10$ s	$P_D$	$T_A = 25^\circ\text{C}$	5.8
		$T_A = 85^\circ\text{C}$	3
Continuous Drain Current $R_{\theta JA}$ (Note 2)	$I_D$	$T_A = 25^\circ\text{C}$	10.2
		$T_A = 85^\circ\text{C}$	7.3
Power Dissipation $R_{\theta JA}$ (Note 2)	$P_D$	$T_A = 25^\circ\text{C}$	0.88
		$T_A = 85^\circ\text{C}$	0.46
Continuous Drain Current $R_{\theta JC}$ (Note 1)	$I_D$	$T_C = 25^\circ\text{C}$	75
		$T_C = 85^\circ\text{C}$	54
Power Dissipation $R_{\theta JC}$ (Note 1)	$P_D$	$T_C = 25^\circ\text{C}$	48
		$T_C = 85^\circ\text{C}$	25
Pulsed Drain Current	$I_{DM}$	225	A
Operating Junction and Storage Temperature	$T_J, T_{STG}$	-55 to +150	$^\circ\text{C}$
Source Current (Body Diode)	$I_S$	40	A
Drain to Source $dV/dt$	$dV/dt$	6	V/ns
Single Pulse Drain-to-Source Avalanche Energy ( $V_{DD} = 30$ V, $V_{GS} = 10$ V, $I_L = 31$ A, $L = 0.3$ mH, $R_G = 25$ $\Omega$ )	EAS	144	mJ
Lead Temperature for Soldering Purposes (1/8" from case for 10 s)	$T_L$	260	$^\circ\text{C}$

Stresses exceeding Maximum Ratings may damage the device. Maximum Ratings are stress ratings only. Functional operation above the Recommended Operating Conditions is not implied. Extended exposure to stresses above the Recommended Operating Conditions may affect device reliability.

1. Surface-mounted on FR4 board using 1 sq-in pad, 1 oz Cu.
2. Surface-mounted on FR4 board using the minimum recommended pad size.



ON Semiconductor®

<http://onsemi.com>

$V_{(BR)DSS}$	$R_{DS(ON)}$ MAX	$I_D$ MAX
30 V	5.0 m $\Omega$ @ 10 V	75 A
	8.0 m $\Omega$ @ 4.5 V	

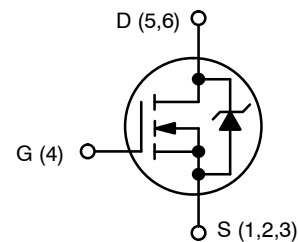

N-CHANNEL MOSFET

### MARKING DIAGRAM

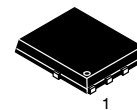

SO-8 FLAT LEAD  
CASE 488AA  
STYLE 1

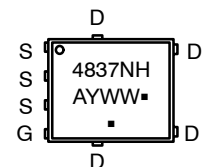

- A = Assembly Location
- Y = Year
- WW = Work Week
- = Pb-Free Package

(Note: Microdot may be in either location)

### ORDERING INFORMATION

Device	Package	Shipping†
NTMFS4837NHT1G	SO-8 FL (Pb-Free)	1500 / Tape & Reel
NTMFS4837NHT3G	SO-8 FL (Pb-Free)	5000 / Tape & Reel

†For information on tape and reel specifications, including part orientation and tape sizes, please refer to our Tape and Reel Packaging Specifications Brochure, BRD8011/D.

\*For additional information on our Pb-Free strategy and soldering details, please download the ON Semiconductor Soldering and Mounting Techniques Reference Manual, SOLDERRM/D.

# NTMFS4837NH

## THERMAL RESISTANCE MAXIMUM RATINGS

Parameter	Symbol	Value	Unit
Junction-to-Case (Drain)	$R_{\theta JC}$	2.6	°C/W
Junction-to-Ambient – Steady State (Note 3)	$R_{\theta JA}$	56.6	
Junction-to-Ambient – Steady State (Note 4)	$R_{\theta JA}$	142	
Junction-to-Ambient ( $t \leq 10$ s)	$R_{\theta JA}$	21.6	

- Surface-mounted on FR4 board using 1 sq-in pad, 1 oz Cu.
- Surface-mounted on FR4 board using the minimum recommended pad size.

## ELECTRICAL CHARACTERISTICS ( $T_J = 25^\circ\text{C}$ unless otherwise specified)

Parameter	Symbol	Test Condition	Min	Typ	Max	Unit
-----------	--------	----------------	-----	-----	-----	------

### OFF CHARACTERISTICS

Drain-to-Source Breakdown Voltage	$V_{(BR)DSS}$	$V_{GS} = 0$ V, $I_D = 250$ $\mu$ A	30			V
Drain-to-Source Breakdown Voltage Temperature Coefficient	$V_{(BR)DSS}/T_J$			27.5		mV/°C
Zero Gate Voltage Drain Current	$I_{DSS}$	$V_{GS} = 0$ V, $V_{DS} = 24$ V	$T_J = 25$ °C		1	$\mu$ A
			$T_J = 125$ °C		10	
Gate-to-Source Leakage Current	$I_{GSS}$	$V_{DS} = 0$ V, $V_{GS} = \pm 20$ V			$\pm 100$	nA

### ON CHARACTERISTICS (Note 5)

Gate Threshold Voltage	$V_{GS(TH)}$	$V_{GS} = V_{DS}$ , $I_D = 250$ $\mu$ A	1.5	2.1	2.5	V	
Negative Threshold Temperature Coefficient	$V_{GS(TH)}/T_J$			5.7		mV/°C	
Drain-to-Source On Resistance	$R_{DS(on)}$	$V_{GS} = 10$ V to 11.5 V	$I_D = 30$ A		3.7	5.0	m $\Omega$
			$I_D = 15$ A		3.7		
		$V_{GS} = 4.5$ V	$I_D = 30$ A		6.5	8.0	
			$I_D = 15$ A		6.4		
Forward Transconductance	$g_{FS}$	$V_{DS} = 1.5$ V, $I_D = 50$ A		67		S	

### CHARGES AND CAPACITANCES

Input Capacitance	$C_{ISS}$	$V_{GS} = 0$ V, $f = 1$ MHz, $V_{DS} = 12$ V		2234	3016	pF
Output Capacitance	$C_{OSS}$			450	608	
Reverse Transfer Capacitance	$C_{RSS}$			243	375	
Total Gate Charge	$Q_{G(TOT)}$	$V_{GS} = 4.5$ V, $V_{DS} = 15$ V; $I_D = 30$ A		15.9	23.8	nC
Threshold Gate Charge	$Q_{G(TH)}$			2.8	4.3	
Gate-to-Source Charge	$Q_{GS}$			6.4	9.5	
Gate-to-Drain Charge	$Q_{GD}$			6.6	9.8	
Total Gate Charge	$Q_{G(TOT)}$	$V_{GS} = 11.5$ V, $V_{DS} = 15$ V; $I_D = 15$ A		34.4	53	nC

### SWITCHING CHARACTERISTICS (Note 6)

Turn-On Delay Time	$t_{d(ON)}$	$V_{GS} = 4.5$ V, $V_{DS} = 15$ V, $I_D = 15$ A, $R_G = 3.0$ $\Omega$		15.2	22.8	ns
Rise Time	$t_r$			27.5	41.3	
Turn-Off Delay Time	$t_{d(OFF)}$			18.3	27.5	
Fall Time	$t_f$			7.1	10.6	

- Pulse Test: pulse width  $\leq 300$   $\mu$ s, duty cycle  $\leq 2\%$ .
- Switching characteristics are independent of operating junction temperatures.

# NTMFS4837NH

## ELECTRICAL CHARACTERISTICS ( $T_J = 25^\circ\text{C}$ unless otherwise specified)

Parameter	Symbol	Test Condition	Min	Typ	Max	Unit
<b>SWITCHING CHARACTERISTICS</b> (Note 6)						
Turn-On Delay Time	$t_{d(ON)}$	$V_{GS} = 11.5\text{ V}, V_{DS} = 15\text{ V},$ $I_D = 15\text{ A}, R_G = 3.0\ \Omega$		9.0	14	ns
Rise Time	$t_r$			19.6	29.3	
Turn-Off Delay Time	$t_{d(OFF)}$			28	38.7	
Fall Time	$t_f$			4.7	7	

## DRAIN-SOURCE DIODE CHARACTERISTICS

Forward Diode Voltage	$V_{SD}$	$V_{GS} = 0\text{ V},$ $I_S = 30\text{ A}$	$T_J = 25^\circ\text{C}$		0.83	1.2	V
			$T_J = 125^\circ\text{C}$		0.71		
Reverse Recovery Time	$t_{RR}$	$V_{GS} = 0\text{ V}, dI_S/dt = 100\text{ A}/\mu\text{s},$ $I_S = 30\text{ A}$		23.5		ns	
Charge Time	$t_a$			11.3			
Discharge Time	$t_b$			12.2			
Reverse Recovery Charge	$Q_{RR}$			8		nC	

## PACKAGE PARASITIC VALUES

Source Inductance	$L_S$	$T_A = 25^\circ\text{C}$		0.93		nH
Drain Inductance	$L_D$			0.005		
Gate Inductance	$L_G$			1.84		
Gate Resistance	$R_G$			0.9		$\Omega$

- Pulse Test: pulse width  $\leq 300\ \mu\text{s}$ , duty cycle  $\leq 2\%$ .
- Switching characteristics are independent of operating junction temperatures.

# NTMFS4837NH

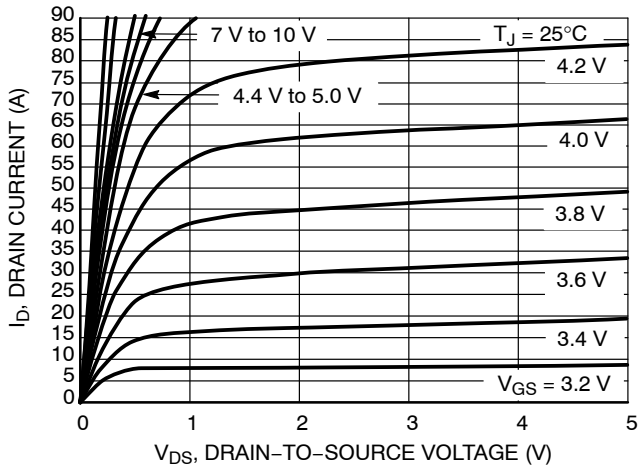

Figure 1. On-Region Characteristics

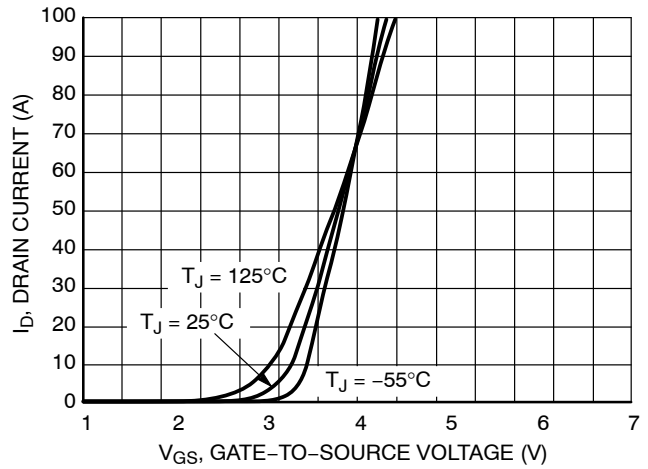

Figure 2. Transfer Characteristics

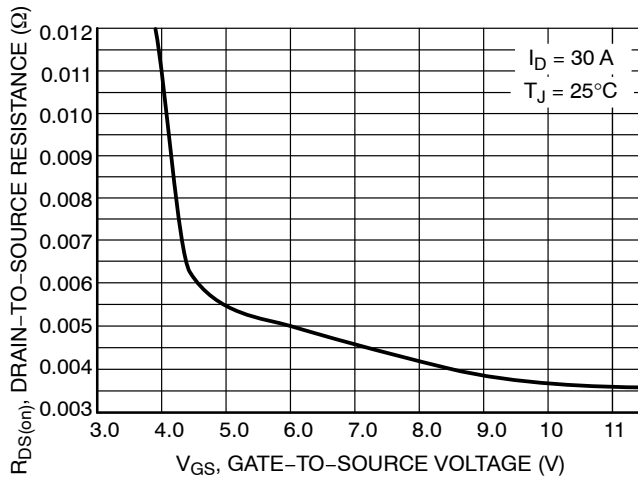

Figure 3. On-Resistance versus Gate-to-Source Voltage

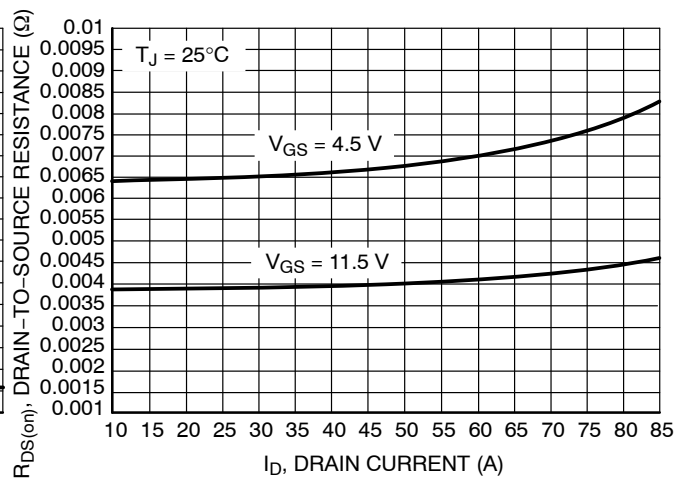

Figure 4. On-Resistance versus Drain Current and Gate Voltage

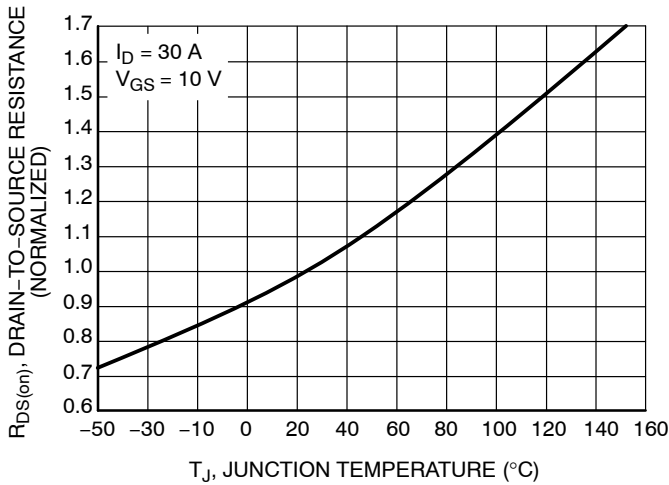

Figure 5. On-Resistance Variation with Temperature

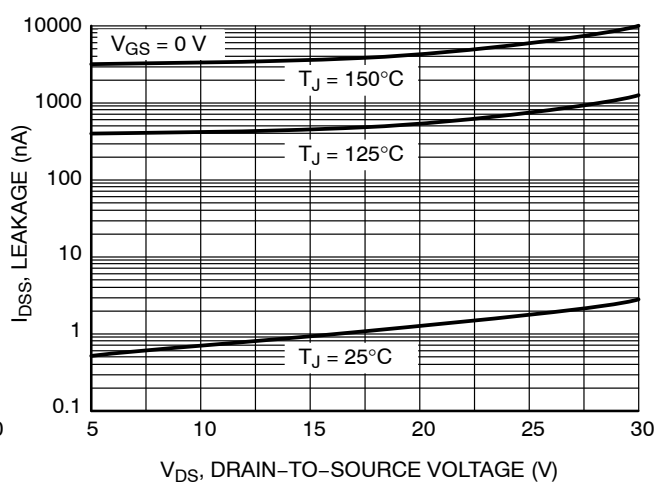
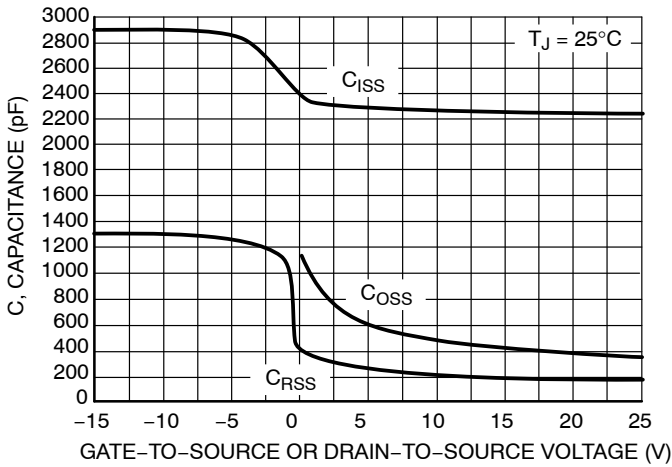
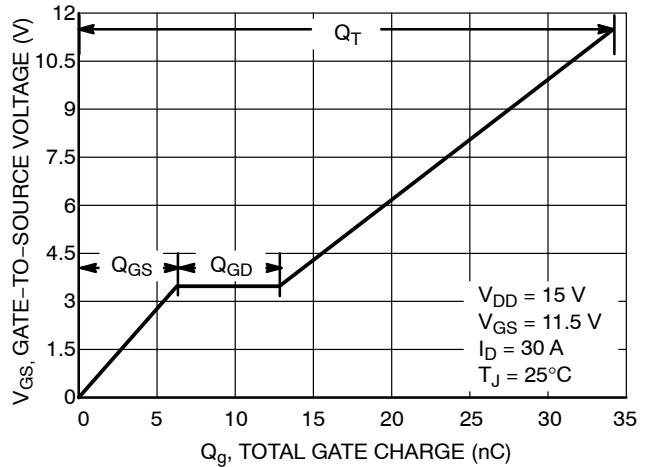

Figure 6. Drain-to-Source Leakage Current versus Voltage

# NTMFS4837NH



**Figure 7. Capacitance Variation**



**Figure 8. Gate-to-Source and Drain-to-Source Voltage vs. Total Gate Charge**

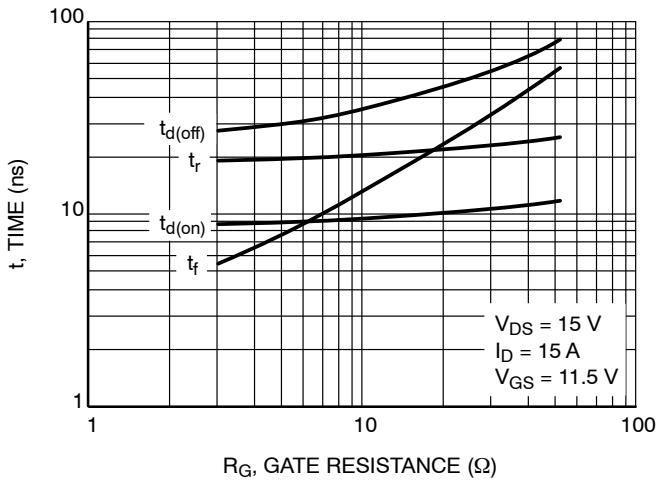

**Figure 9. Resistive Switching Time Variation versus Gate Resistance**

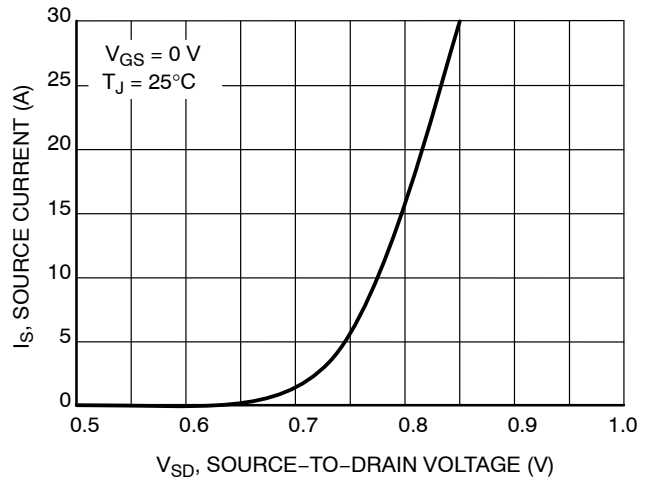

**Figure 10. Diode Forward Voltage versus Current**

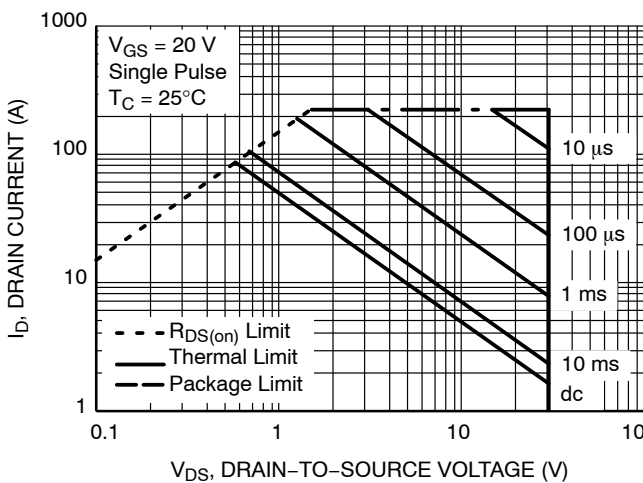

**Figure 11. Maximum Rated Forward Biased Safe Operating Area**

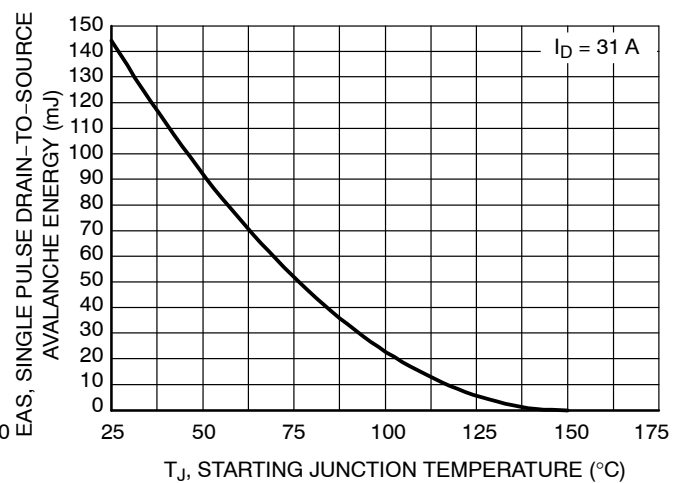

**Figure 12. Maximum Avalanche Energy versus Starting Junction Temperature**

# NTMFS4837NH

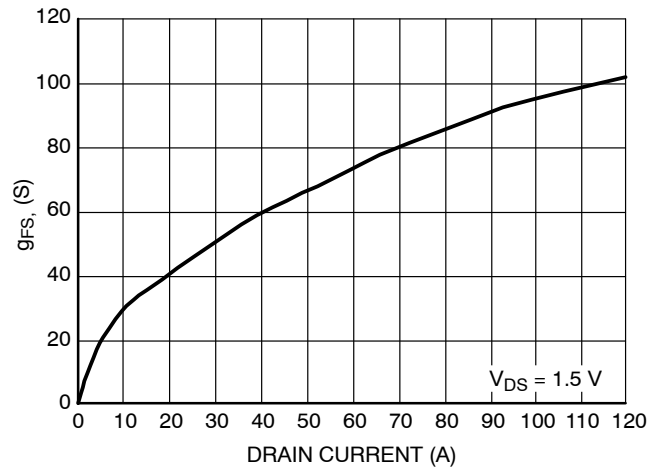
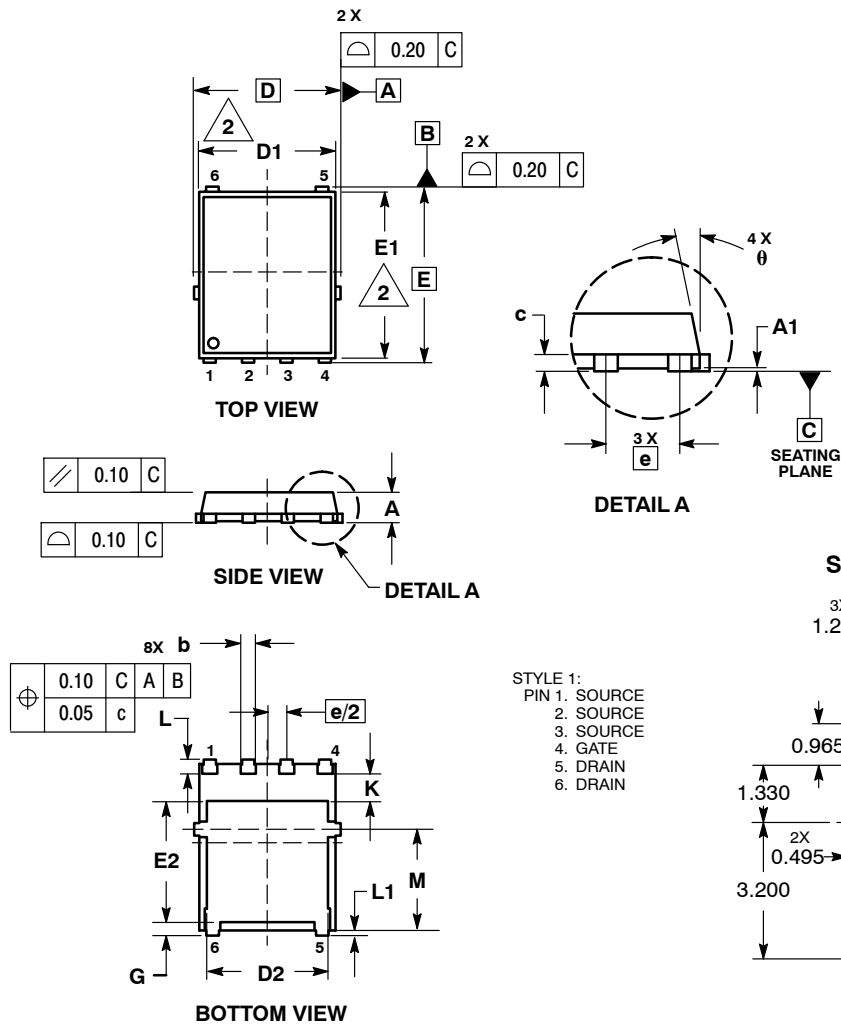

Figure 13.  $g_{FS}$  versus Drain Current

# NTMFS4837NH

## PACKAGE DIMENSIONS

DFN6 5x6, 1.27P (S08 FL)  
CASE 488AA-01  
ISSUE C



**NOTES:**

1. DIMENSIONING AND TOLERANCING PER ASME Y14.5M, 1994.
2. CONTROLLING DIMENSION: MILLIMETER.
3. DIMENSION D1 AND E1 DO NOT INCLUDE MOLD FLASH PROTRUSIONS OR GATE BURRS.

DIM	MILLIMETERS		
	MIN	NOM	MAX
A	0.90	1.00	1.10
A1	0.00	---	0.05
b	0.33	0.41	0.51
c	0.23	0.28	0.33
D	5.15 BSC		
D1	4.50	4.90	5.10
D2	3.50	---	4.22
E	6.15 BSC		
E1	5.50	5.80	6.10
E2	3.45	---	4.30
e	1.27 BSC		
G	0.51	0.61	0.71
K	0.51	---	---
L	0.51	0.61	0.71
L1	0.05	0.17	0.20
M	3.00	3.40	3.80
theta	0°	---	12°

**SOLDERING FOOTPRINT\***

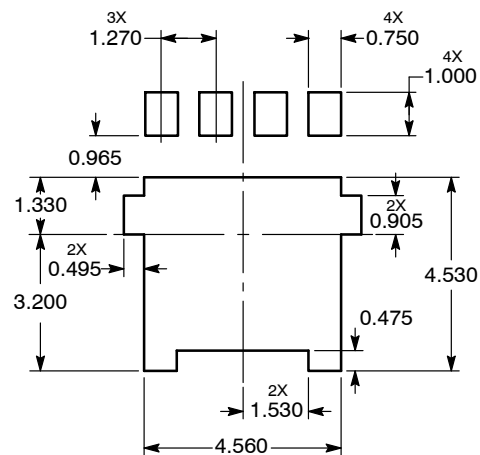

- STYLE 1:  
PIN 1. SOURCE  
2. SOURCE  
3. SOURCE  
4. GATE  
5. DRAIN  
6. DRAIN

\*For additional information on our Pb-Free strategy and soldering details, please download the ON Semiconductor Soldering and Mounting Techniques Reference Manual, SOLDERRM/D.

ON Semiconductor and are registered trademarks of Semiconductor Components Industries, LLC (SCILLC). SCILLC reserves the right to make changes without further notice to any products herein. SCILLC makes no warranty, representation or guarantee regarding the suitability of its products for any particular purpose, nor does SCILLC assume any liability arising out of the application or use of any product or circuit, and specifically disclaims any and all liability, including without limitation special, consequential or incidental damages. "Typical" parameters which may be provided in SCILLC data sheets and/or specifications can and do vary in different applications and actual performance may vary over time. All operating parameters, including "Typicals" must be validated for each customer application by customer's technical experts. SCILLC does not convey any license under its patent rights nor the rights of others. SCILLC products are not designed, intended, or authorized for use as components in systems intended for surgical implant into the body, or other applications intended to support or sustain life, or for any other application in which the failure of the SCILLC product could create a situation where personal injury or death may occur. Should Buyer purchase or use SCILLC products for any such unintended or unauthorized application, Buyer shall indemnify and hold SCILLC and its officers, employees, subsidiaries, affiliates, and distributors harmless against all claims, costs, damages, and expenses, and reasonable attorney fees arising out of, directly or indirectly, any claim of personal injury or death associated with such unintended or unauthorized use, even if such claim alleges that SCILLC was negligent regarding the design or manufacture of the part. SCILLC is an Equal Opportunity/Affirmative Action Employer. This literature is subject to all applicable copyright laws and is not for resale in any manner.

**PUBLICATION ORDERING INFORMATION**



**LITERATURE FULFILLMENT:**  
Literature Distribution Center for ON Semiconductor  
P.O. Box 5163, Denver, Colorado 80217 USA  
Phone: 303-675-2175 or 800-344-3860 Toll Free USA/Canada  
Fax: 303-675-2176 or 800-344-3867 Toll Free USA/Canada  
Email: orderlit@onsemi.com

**N. American Technical Support:** 800-282-9855 Toll Free USA/Canada  
**Europe, Middle East and Africa Technical Support:**  
Phone: 421 33 790 2910  
**Japan Customer Focus Center**  
Phone: 81-3-5773-3850

**ON Semiconductor Website:** [www.onsemi.com](http://www.onsemi.com)  
**Order Literature:** <http://www.onsemi.com/orderlit>  
For additional information, please contact your local Sales Representative

## Looking for pricing, stock, or lifecycle information?

Click below to explore more details on WIN SOURCE:

-  [View NTMFS4837NHT3G on WIN SOURCE](#)
-  [ON Semiconductor Information](#)

## Optimize Your Supply Chain with WIN SOURCE Solutions

-  Global Sourcing Solution
-  Obsolete Management
-  Cost Control Management
-  Shortage Management
-  Alternative Solution
-  Excess Inventory Management