



**THE DATASHEET OF
AD9214BRSZ-105**



AD9214

FEATURES

SNR = 57 dB @ 39 MHz Analog Input (−0.5 dBFS)

Low Power

190 mW at 65 MSPS

285 mW at 105 MSPS

30 mW Power-Down Mode

300 MHz Analog Bandwidth

On-Chip Reference and Track/Hold

1 V p-p or 2 V p-p Analog Input Range Option

Single 3.3 V Supply Operation (2.7 V–3.6 V)

Two's Complement or Offset Binary Data Format Option

APPLICATIONS

Battery-Powered Instruments

Hand-Held Scopemeters

Low-Cost Digital Oscilloscopes

Ultrasound Equipment

Cable Reverse Path

Broadband Wireless

Residential Power Line Networks

FUNCTIONAL BLOCK DIAGRAM

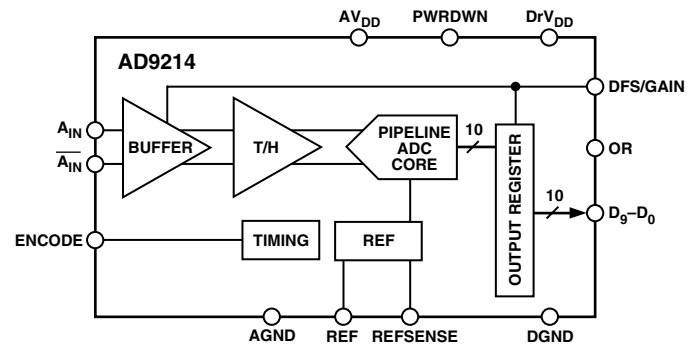

PRODUCT DESCRIPTION

The AD9214 is a 10-bit monolithic sampling analog-to-digital converter (ADC) with an on-chip track-and-hold circuit, and is optimized for low cost, low power, small size, and ease of use. The product operates up to 105 MSPS conversion rate with outstanding dynamic performance over its full operating range.

The ADC requires only a single 3.3 V (2.7 V to 3.6 V) power supply and an encode clock for full performance operation. No external reference or driver components are required for many applications. The digital outputs are TTL/CMOS compatible and a separate output power supply pin supports interfacing with 3.3 V or 2.5 V logic.

The clock input is TTL/CMOS compatible. In the power-down state, the power is reduced to 30 mW. A gain option allows support for either 1 V p-p or 2 V p-p analog signal input swing.

Fabricated on an advanced CMOS process, the AD9214 is available in a 28-lead surface-mount plastic package (28-SSOP) specified over the industrial temperature range (−40°C to +85°C).

PRODUCT HIGHLIGHTS

High Performance—Outstanding ac performance from 65 MSPS to 105 MSPS. SNR greater than 55 dB typical and as high as 58 dB.

Low Power—The AD9214 at 285 mW consumes a fraction of the power available in existing high-speed monolithic solutions. In sleep mode, power is reduced to 30 mW.

Single Supply—The AD9214 uses a single 3 V supply, simplifying system power supply design. It also features a separate digital output driver supply line to accommodate 2.5 V logic families.

Small Package—The AD9214 is packaged in a small 28-lead surface-mount plastic package (28-SSOP).

REV. D

Information furnished by Analog Devices is believed to be accurate and reliable. However, no responsibility is assumed by Analog Devices for its use, nor for any infringements of patents or other rights of third parties that may result from its use. No license is granted by implication or otherwise under any patent or patent rights of Analog Devices.

AD9214—SPECIFICATIONS

DC SPECIFICATIONS ($A_{V_{DD}} = 3\text{ V}$, $D_{rV_{DD}} = 3\text{ V}$; $T_{\text{MIN}} = -40^{\circ}\text{C}$, $T_{\text{MAX}} = +85^{\circ}\text{C}$; external 1.25 V voltage reference and rated encode frequency used, unless otherwise noted.)

Parameter	Temp	Test Level	AD9214-65			AD9214-80			AD9214-105			Unit
			Min	Typ	Max	Min	Typ	Max	Min	Typ	Max	
RESOLUTION			10			10			10			Bits
ACCURACY			Guaranteed			Guaranteed			Guaranteed			
No Missing Codes	25°C	VI	Guaranteed			Guaranteed			Guaranteed			
Offset Error	Full	VI	Guaranteed			Guaranteed			Guaranteed			LSB
Gain Error ¹	25°C	I	-18	0	+18	-18	0	+18	-18	0	+18	% FS
Differential Nonlinearity ² (DNL)	25°C	I	-2		+8	-2		+8	-2		+8	LSB
Integral Nonlinearity ² (INL)	25°C	I	-1.0	±0.5	+1.0	-1.0	±0.5	+1.2	-1.0	±0.8	+1.5	LSB
	Full	V	-1.0		+1.2	-1.0		+1.4	-1.0		+1.7	LSB
	25°C	I	-1.35	±0.75	+1.35	-1.5	±0.75	+1.5	-2.2	±1.5	+2.2	LSB
	Full	V	-1.9		+1.9	-1.8		+1.8	-2.5		+2.5	LSB
TEMPERATURE DRIFT												
Offset Error	Full	V	16			16			16			ppm/°C
Gain Error ¹	Full	V	150			150			150			ppm/°C
Reference Voltage	Full	V	80			80			80			ppm/°C
REFERENCE (REF)												
Internal Reference Voltage	25°C	VI	1.18	1.23	1.28	1.18	1.23	1.28	1.18	1.23	1.28	V
Output Current ³	Full	V	200			200			200			μA
Input Current ⁴	Full	V	123			123			123			μA
Input Resistance	Full	V	10			10			10			kΩ
ANALOG INPUTS (A_{IN} , $\overline{A_{\text{IN}}}$)												
Differential Input Range	Full	V	1 or 2			1 or 2			1 or 2			V p-p
Common-Mode Voltage	Full	V	$A_{V_{DD}}/3$			$A_{V_{DD}}/3$			$A_{V_{DD}}/3$			V
Differential Input Resistance ⁵	Full	V	20			20			20			kΩ
Differential Input Capacitance	Full	V	5			5			5			pF
POWER SUPPLY												
Supply Voltages												
$A_{V_{DD}}$	Full	IV	2.7		3.6	2.7		3.6	2.7		3.6	V
$D_{rV_{DD}}$	Full	IV	2.7		3.6	2.7		3.6	2.7		3.6	V
Supply Current												
$I_{A_{V_{DD}}}$ ($A_{V_{DD}} = 3.0\text{ V}$) ⁶	Full	VI	64		75	90		105	95		110	mA
Power-Down Current ⁷												
$I_{A_{V_{DD}}}$ ($A_{V_{DD}} = 3.0\text{ V}$)	Full	VI	10		15	10		15	10		15	mA
Power Consumption ⁸	Full	VI	190		220	250		300	285		325	mW
PSRR	25°C	I	±0.5			±1			±1			LSB/V
	Full	V	±2			±2			±2			mV/V

NOTES

¹Gain error and gain temperature coefficient are based on the ADC only (with a fixed 1.25 V external reference).

²Measured with 1 V A_{IN} range for AD9214-80 and AD9214-105. Measured with 2 V A_{IN} range for AD9214-65.

³REFSENSE externally connected to AGND, REF is configured as an output for the internal reference voltage.

⁴REFSENSE externally connected to $A_{V_{DD}}$, REF is configured as an input for an external reference voltage.

⁵10 kΩ to $A_{V_{DD}}/3$ on each input.

⁶ $I_{A_{V_{DD}}}$ is measured with an analog input of 10.3 MHz, 0.5 dBFS, sine wave, rated encode rate, and PWRDN = 0. See Typical Performance Characteristics and Applications section for $I_{D_{rV_{DD}}}$.

⁷Power-down supply currents measured with PWRDN = 1; rated encode rate, A_{IN} = full-scale dc input.

⁸Power consumption measured with A_{IN} = full-scale dc input.

Specifications subject to change without notice.

DIGITAL SPECIFICATIONS ($V_{DD} = 3\text{ V}$, $DrV_{DD} = 3\text{ V}$; $T_{MIN} = -40^{\circ}\text{C}$, $T_{MAX} = +85^{\circ}\text{C}$)

Parameter	Temp	Test Level	AD9214-65			AD9214-80			AD9214-105			Unit
			Min	Typ	Max	Min	Typ	Max	Min	Typ	Max	
DIGITAL INPUTS ¹												
Logic "1" Voltage	Full	IV	2.0			2.0			2.0			V
Logic "0" Voltage	Full	IV			0.8			0.8			0.8	V
Input Capacitance	Full	V		2.0			2.0			2.0		pF
DIGITAL OUTPUTS ²												
Logic Compatibility			CMOS/TTL			CMOS/TTL			CMOS/TTL			V
Logic "1" Voltage	Full	VI	$DrV_{DD} - 50\text{ mV}$			$DrV_{DD} - 50\text{ mV}$			$DrV_{DD} - 50\text{ mV}$			V
Logic "0" Voltage	Full	VI			50			50			50	mV

NOTES

¹Digital Inputs include ENCODE and PWRDN.²Digital Outputs include D0–D9 and OR.

Specifications subject to change without notice.

AC SPECIFICATIONS¹ ($V_{DD} = 3\text{ V}$, $DrV_{DD} = 3\text{ V}$; ENCODE = Maximum Conversion Rate; $T_{MIN} = -40^{\circ}\text{C}$, $T_{MAX} = +85^{\circ}\text{C}$; external 1.25 V voltage reference used, unless otherwise noted.)

Parameter	Temp	Test Level	AD9214-65			AD9214-80			AD9214-105			Unit
			Min	Typ	Max	Min	Typ	Max	Min	Typ	Max	
SNR												
Analog Input 10 MHz	25°C	I	55.5	58.3		56.0	58.1		51.0	53.0		dB
@ -0.5 dBFS 39 MHz	25°C	I		57.1		55.0	57.1		50.5	53.0		dB
51 MHz	25°C	V					55.0			53.0		dB
70 MHz	25°C	V					54.0			52.6		dB
SINAD												
Analog Input 10 MHz	25°C	I	55.0	57.8		55.5	57.6		50.0	52.0		dB
@ -0.5 dBFS 39 MHz	25°C	I		56.7		54.5	56.7		50.0	52.0		dB
51 MHz	25°C	V					54.5			52.0		dB
70 MHz	25°C	V								52.0		dB
EFFECTIVE NUMBER OF BITS												
Analog Input 10 MHz	25°C	I	8.9	9.3		9.0	9.3			8.4		Bit
@ -0.5 dBFS 39 MHz	25°C	I		9.2		8.8	9.2			8.4		Bit
51 MHz	25°C	V					8.8			8.4		Bit
70 MHz	25°C	V					8.5			8.4		Bit
SECOND HARMONIC DISTORTION												
Analog Input 10 MHz	25°C	I	-66	-79		-64	-74		-62	-68		dBc
@ -0.5 dBFS 39 MHz	25°C	I		-75		-63	-76		-62	-71		dBc
51 MHz	25°C	V					-72			-64		dBc
70 MHz	25°C	V					-65			-62		dBc
THIRD HARMONIC DISTORTION												
Analog Input 10 MHz	25°C	I	-63.5	-71		-63	-72		-59	-64		dBc
@ -0.5 dBFS 39 MHz	25°C	I		-70		-63	-74		-59	-67		dBc
51 MHz	25°C	V					-78			-71		dBc
70 MHz	25°C	V								-65		dBc
SFDR												
Analog Input 10 MHz	25°C	I	63.5	71		63	71		57	62		dBc
@ -0.5 dBFS 39 MHz	25°C	I		70		63	71		57	62		dBc
51 MHz	25°C	V					67			62		dBc
70 MHz	25°C	V					64			62		dBc
TWO-TONE INTERMOD DISTORTION ²												
Analog Input @ -0.5 dBFS	25°C	V		76			74			72		dBFS
ANALOG INPUT BANDWIDTH	25°C	V		300			300			300		MHz

NOTES

¹AC specifications based on a 1.0 V p-p full-scale input range for the AD9214-80 and AD9214-105, and a 2.0 V p-p full-scale input range for the AD9214-65. An external reference is used.²F1 = 29.3 MHz, F2 = 30.3 MHz.

Specifications subject to change without notice.

AD9214—SPECIFICATIONS

SWITCHING SPECIFICATIONS ($V_{DD} = 3\text{ V}$, $D rV_{DD} = 3\text{ V}$; ENCODE = Maximum Conversion Rate; $T_{MIN} = -40^{\circ}\text{C}$, $T_{MAX} = +85^{\circ}\text{C}$; external 1.25 V voltage reference used, unless otherwise noted.)

Parameter	Temp	Test Level	AD9214-65			AD9214-80			AD9214-105			Unit
			Min	Typ	Max	Min	Typ	Max	Min	Typ	Max	
ENCODE INPUT PARAMETERS*												
Maximum Conversion Rate	Full	VI	65			80			105			MSPS
Minimum Conversion Rate	Full	IV			20			20			20	MSPS
Encode Pulsewidth High (t_{EH})	Full	IV	6.0			5.0			3.8			ns
Encode Pulsewidth Low (t_{EL})	Full	IV	6.0			5.0			3.8			ns
Aperture Delay (t_A)	25°C	V		2.0			2.0			2.0		ns
Aperture Uncertainty (Jitter)	25°C	V		3			3			3		ps rms
DATA OUTPUT PARAMETERS												
Pipeline Delays	Full	IV		5			5			5		Clock Cycle
Output Valid Time (t_V)*	Full	V	3.0	4.5		3.0	4.5		3.0	4.5		ns
Output Propagation Delay* (t_{PD})	Full	V		4.5	6.0		4.5	6.0		4.5	6.0	ns
TRANSIENT RESPONSE TIME	25°C	V		5			5			5		ns
OUT-OF-RANGE RECOVERY TIME	25°C	V		5			5			5		ns

* t_V and t_{PD} are measured from the 1.5 V level of the ENCODE input to the 50% levels of the digital output swing. The digital output load during test is not to exceed an ac load of 5 pF or a dc current of $\pm 40\ \mu\text{A}$.

Specifications subject to change without notice.

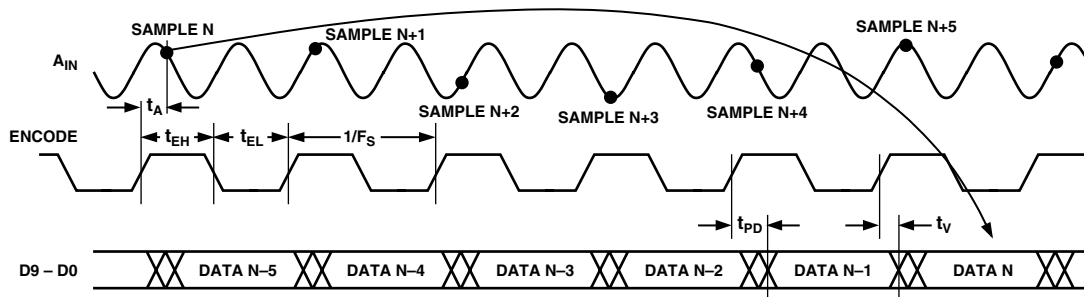

Figure 1. Timing Diagram

ABSOLUTE MAXIMUM RATINGS¹**Electrical**

AV _{DD} Voltage	4 V max
DrV _{DD} Voltage	4 V max
Analog Input Voltage	-0.5 V to AV _{DD} + 0.5 V
Analog Input Current	0.4 mA
Digital Input Voltage	-0.5 V to AV _{DD} + 0.5 V
Digital Output Current	20 mA max
REF Input Voltage	-0.5 V to AV _{DD} + 0.5 V

Environmental²

Operating Temperature Range (Ambient)	-40°C to +125°C
Maximum Junction Temperature	150°C
Lead Temperature (Soldering, 10 sec)	150°C
Storage Temperature Range (Ambient)	-65°C to +150°C

NOTES

¹Absolute maximum ratings are limiting values to be applied individually, and beyond which the serviceability of the circuit may be impaired. Functional operability is not necessarily implied. Exposure to absolute maximum rating conditions for an extended period of time may affect device reliability.

²Typical thermal impedances (package = 28 SSOP); $\theta_{JA} = 49^{\circ}\text{C/W}$. These measurements were taken on a 6-layer board in still air with a solid ground plane.

EXPLANATION OF TEST LEVELS

- I 100% production tested.
- II 100% production tested at 25°C and guaranteed by design and characterization at specified temperatures.
- III Sample Tested Only
- IV Parameter is guaranteed by design and characterization testing.
- V Parameter is a typical value only.
- VI 100% production tested at 25°C and guaranteed by design and characterization for industrial temperature range.

ORDERING GUIDE

Model	Temperature Range	Package Description	Package Option
AD9214BRS-65	-40°C to +85°C (Ambient)	28-Lead Shrink Small Outline Package	RS-28
AD9214BRS-80	-40°C to +85°C (Ambient)	28-Lead Shrink Small Outline Package	RS-28
AD9214BRS-105	-40°C to +85°C (Ambient)	28-Lead Shrink Small Outline Package	RS-28
AD9214-65PCB	25°C	Evaluation Board with AD9214-65	
AD9214-105PCB	25°C	Evaluation Board with AD9214-105	

CAUTION

ESD (electrostatic discharge) sensitive device. Electrostatic charges as high as 4000 V readily accumulate on the human body and test equipment and can discharge without detection. Although the AD9214 features proprietary ESD protection circuitry, permanent damage may occur on devices subjected to high-energy electrostatic discharges. Therefore, proper ESD precautions are recommended to avoid performance degradation or loss of functionality.



PIN FUNCTION DESCRIPTIONS

Pin No.	Mnemonic	Function
1	OR	CMOS Output; Out-of-Range Indicator. Logic HIGH indicates the analog input voltage was outside the converter's range for the current output data.
2	DFS/GAIN	Data Format Select and Gain Mode Select. Connect externally to AV_{DD} for two's complement data format and 1 V p-p analog input range. Connect externally to AGND for Offset Binary data format and 1 V p-p analog input range. Connect externally to REF (Pin 4) for two's complement data format and 2 V p-p analog input range. Floating this pin will configure the device for Offset Binary data format and a 2 V p-p analog input range.
3	REFSENSE	Reference Mode Select Pin for the ADC. This pin is normally connected externally to AGND, which enables the internal 1.25 V reference, and configures REF (Pin 4) as an analog reference output pin. Connecting REFSENSE externally to AV_{DD} disables the internal reference, and configures REF (Pin 4) as an external reference input. In this case, the user must drive REF with a clean and accurate 1.25 V ($\pm 5\%$) reference input.
4	REF	Reference input or output as configured by REFSENSE (Pin 3). When configured as an output (REFSENSE = AGND), the internal reference (nominally 1.25 V) is enabled and is available to the user on this pin. When configured as an input (REFSENSE = AV_{DD}), the user must drive REF with a clean and accurate 1.25 V ($\pm 5\%$) reference. This pin should be bypassed to AGND with an external 0.1 μ F capacitor, whether it is configured as an input or output.
5, 8, 11	AGND	Analog Ground
6, 7, 12	AV_{DD}	Analog Power Supply, Nominally 3 V
9	A_{IN}	Positive terminal of the differential analog input for the ADC.
10	\overline{A}_{IN}	Negative terminal of the differential analog input for the ADC. This pin can be left open if operating in single-ended mode, but it is preferable to match the impedance seen at the positive terminal (see Driving the Analog Inputs).
13	ENCODE	Encode Clock for the ADC. The AD9214 samples the analog signal on the rising edge of ENCODE.
14	PWRDN	CMOS-compatible power-down mode select, Logic LOW for normal operation; Logic HIGH for power-down mode (digital outputs in high impedance state). PWRDN has an internal 10 k Ω pull-down resistor to ground.
15, 23	DGND	Digital Output Ground
16, 24	DrV_{DD}	Digital Output Driver Power Supply. Nominally 2.5 V to 3.6 V.
17–22, 25–28	D0 (LSB)–D5, D6–D9 (MSB)	CMOS Digital Outputs of ADC

PIN CONFIGURATION

28-Lead Shrink Small Outline Package

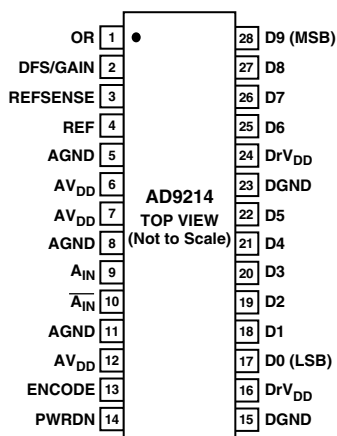

TERMINOLOGY**Analog Bandwidth**

The analog input frequency at which the spectral power of the fundamental frequency (as determined by the FFT analysis) is reduced by 3 dB.

Aperture Delay

The delay between the 50% point of the rising edge of the ENCODE command and the instant at which the analog input is sampled.

Aperture Uncertainty (Jitter)

The sample-to-sample variation in aperture delay.

Differential Analog Input Resistance, Differential Analog Input Capacitance and Differential Analog Input Impedance

The real and complex impedances measured at each analog input port. The resistance is measured statically and the capacitance and differential input impedances are measured with a network analyzer.

Differential Analog Input Voltage Range

The peak-to-peak differential voltage that must be applied to the converter to generate a full-scale response. Peak differential voltage is computed by observing the voltage on a single pin and subtracting the voltage from the other pin, which is 180 degrees out of phase. Peak-to-peak differential is computed by rotating the inputs phase 180 degrees and taking the peak measurement again. Then the difference is computed between both peak measurements.

Differential Nonlinearity

The deviation of any code width from an ideal 1 LSB step.

Effective Number of Bits

The effective number of bits (ENOB) is calculated from the measured SNR based on the equation:

$$ENOB = \frac{SINAD_{MEASURED} - 1.76 \text{ dB} + 20 \log \left(\frac{\text{Full Scale}}{\text{Actual}} \right)}{6.02}$$

Encode Pulsewidth/Duty Cycle

Pulsewidth high is the minimum amount of time that the ENCODE pulse should be left in Logic “1” state to achieve rated performance; pulsewidth low is the minimum time ENCODE pulse should be left in low state. See timing implications of changing t_{ENCH} in text. At a given clock rate, these specs define an acceptable Encode duty cycle.

Full-Scale Input Power

Expressed in dBm. Computed using the following equation:

$$Power_{FULL\ SCALE} = 10 \log \left(\frac{V^2_{FULL\ SCALE\ rms}}{\frac{Z_{INPUT}}{0.001}} \right)$$

Gain Error

Gain error is the difference between the measured and ideal full scale input voltage range of the ADC.

Harmonic Distortion, Second

The ratio of the rms signal amplitude to the rms value of the second harmonic component, reported in dBc.

Harmonic Distortion, Third

The ratio of the rms signal amplitude to the rms value of the third harmonic component, reported in dBc.

Integral Nonlinearity

The deviation of the transfer function from a reference line measured in fractions of 1 LSB using a “best straight line” determined by a least square curve fit.

Minimum Conversion Rate

The encode rate at which the SNR of the lowest analog signal frequency drops by no more than 3 dB below the guaranteed limit.

Maximum Conversion Rate

The encode rate at which parametric testing is performed.

Output Propagation Delay

The delay between a differential crossing of ENCODE and ENCODE and the time when all output data bits are within valid logic levels.

Noise (for any range within the ADC)

$$V_{NOISE} = \sqrt{Z \times 0.001 \times 10 \frac{FS_{dBm} - SNR_{dBc} - Signal_{dBFS}}{10}}$$

Where Z is the input impedance, FS is the full-scale of the device for the frequency in question, SNR is the value for the particular input level and $Signal$ is the signal level within the ADC reported in dB below full-scale. This value includes both thermal and quantization noise.

Power Supply Rejection Ratio (PSRR)

The ratio of a change in input offset voltage to a change in power supply voltage.

Signal-to-Noise-and-Distortion (SINAD)

The ratio of the rms signal amplitude (set 0.5 dB below full scale) to the rms value of the sum of all other spectral components, including harmonics but excluding dc.

Signal-to-Noise Ratio (without Harmonics)

The ratio of the rms signal amplitude (set at 0.5 dB below full scale) to the rms value of the sum of all other spectral components, excluding the first five harmonics and dc.

Spurious-Free Dynamic Range (SFDR)

The ratio of the rms signal amplitude to the rms value of the peak spurious spectral component. The peak spurious component may or may not be a harmonic. May be reported in dBc (i.e., degrades as signal level is lowered), or dBFS (always related back to converter full scale).

Two-Tone Intermodulation Distortion Rejection

The ratio of the rms value of either input tone to the rms value of the worst third order intermodulation product; reported in dBc.

Two-Tone SFDR

The ratio of the rms value of either input tone to the rms value of the peak spurious component. The peak spurious component may or may not be an intermodulation distortion product. May be reported in dBc (i.e., degrades as signal level is lowered), or in dBFS (always related back to converter full scale).

Worst Other Spur

The ratio of the rms signal amplitude to the rms value of the worst spurious component (excluding the second and third harmonic) reported in dBc.

AD9214

Transient Response Time

Transient response is defined as the time it takes for the ADC to reacquire the analog input after a transient from 10% above negative full scale to 10% below positive full scale.

Out-of-Range Recovery Time

Out-of-range recovery time is the time it takes for the ADC to reacquire the analog input after a transient from 10% above positive full scale to 10% above negative full scale, or from 10% below negative full scale to 10% below positive full scale.

EQUIVALENT CIRCUITS

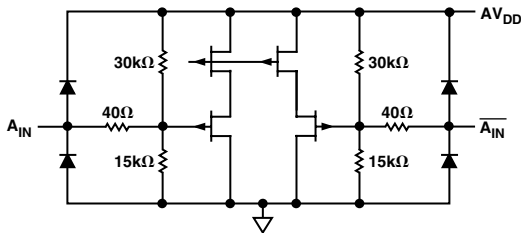

Figure 2. Analog Input Stage

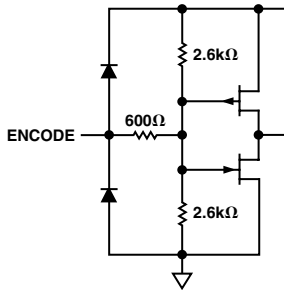

Figure 3. Encode Inputs

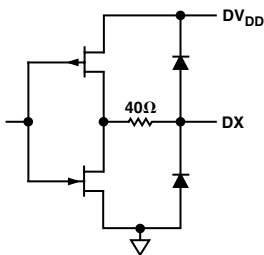

Figure 4. Digital Output Stage

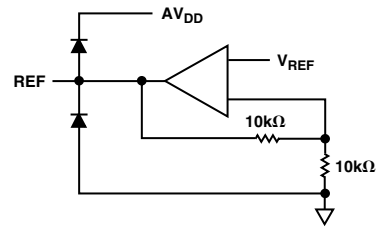

Figure 5. REF Configured as an Output

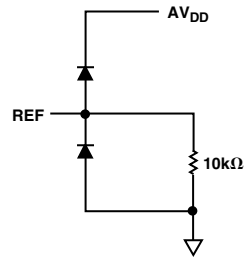
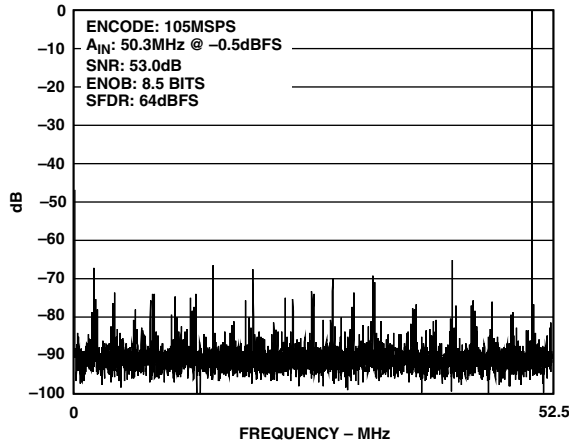
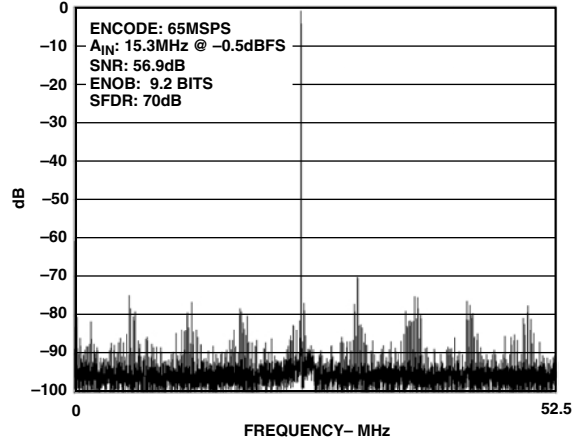

Figure 6. REF Configured as an Input

Typical Performance Characteristics—AD9214



TPC 1. FFT: $f_S = 105$ MSPS, $f_{IN} = \sim 50.3$ MHz; $A_{IN} = -0.5$ dBFS Differential, 1 V p-p Analog Input Range



TPC 4. FFT: $f_S = 65$ MSPS, $f_{IN} = 15.3$ MHz (2 V p-p) with AD8138 Driving A_{IN}

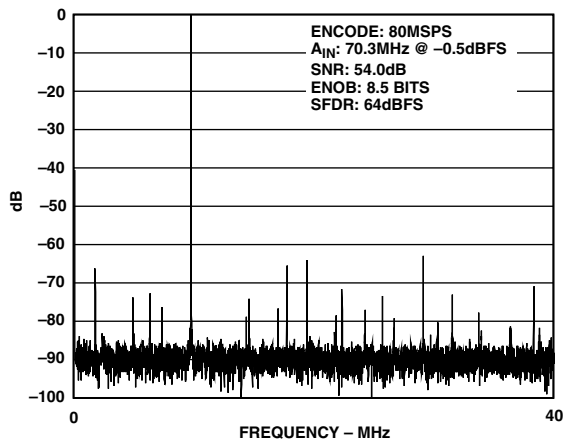

TPC 2. FFT: $f_S = 80$ MSPS, $f_{IN} = 70$ MHz; $A_{IN} = -0.5$ dBFS, 1 V p-p Analog Input Range

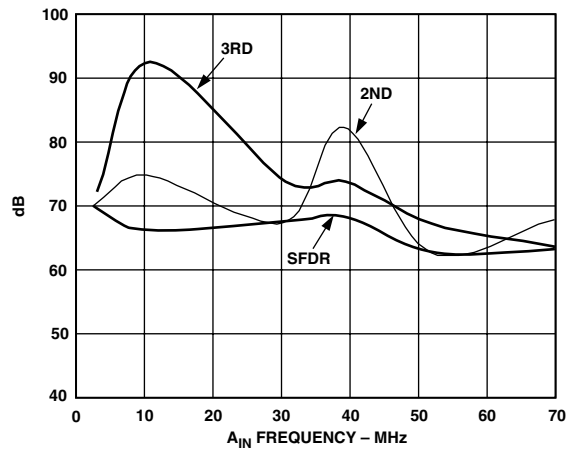

TPC 5. Harmonic Distortion (Second and Third) and SFDR vs. A_{IN} Frequency (1 V p-p, $f_S = 105$ MSPS)

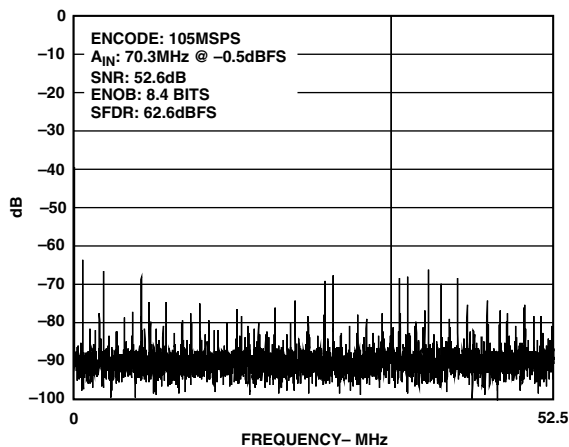

TPC 3. FFT: $f_S = 105$ MSPS; $f_{IN} = 70$ MHz (1 V p-p)

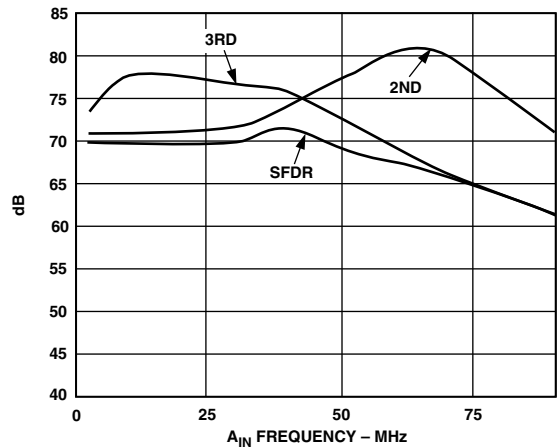

TPC 6. Harmonic Distortion (Second and Third) and SFDR vs. A_{IN} Frequency (1 V p-p, $f_S = 80$ MSPS)

AD9214

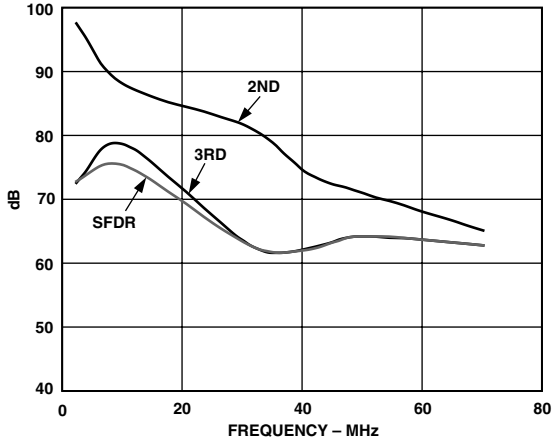

TPC 7. Harmonic Distortion (Second and Third) and SFDR vs. A_{IN} Frequency (1 V p-p and 2 V p-p, $f_S = 65$ MSPS)

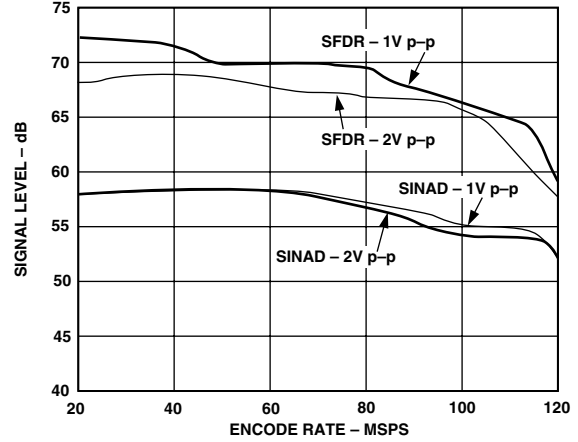

TPC 10. SINAD and SFDR vs. Encode Rate ($f_{IN} = 10.3$ MHz; 1 V p-p and 2 V p-p)

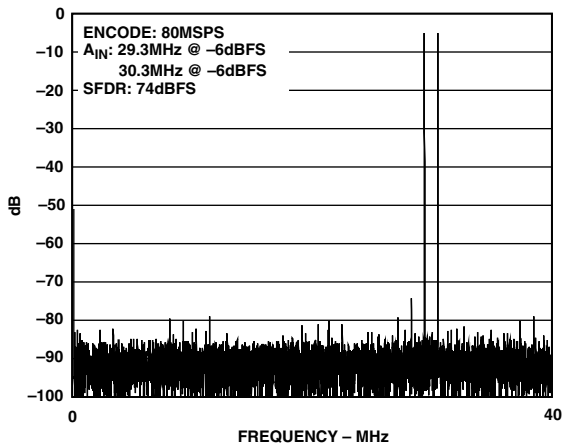

TPC 8. Two-Tone Intermodulation Distortion (29.3 MHz, 30.3 MHz; 1 V p-p, $f_S = 80$ MSPS)

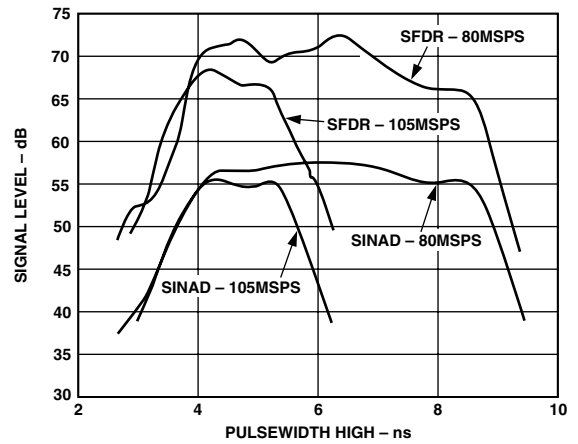

TPC 11. SINAD and SFDR vs. Encode Pulsewidth High (1 V p-p)

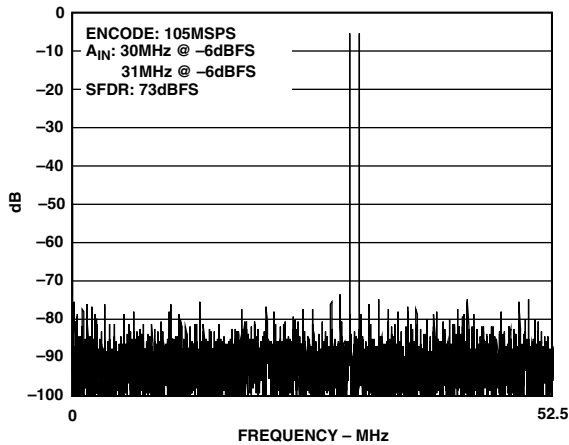

TPC 9. Two-Tone Intermodulation Distortion (30 MHz and 31 MHz; 1 V p-p, $f_S = 105$ MSPS)

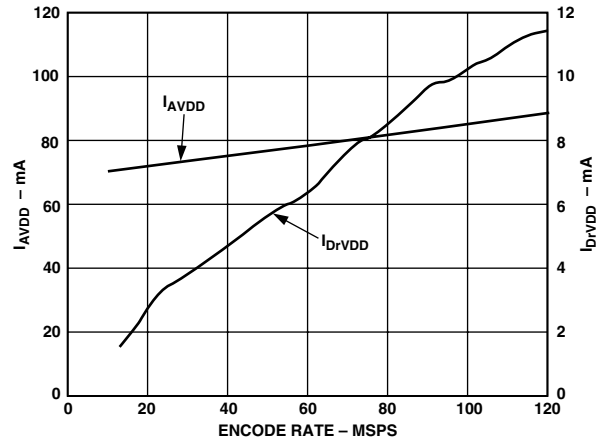

TPC 12. I_{AVDD} and I_{DrVDD} vs. Encode Rate ($f_{AIN} = 10.3$ MHz, -0.5 dBFS, and -3 dBFS) C_{LOAD} on Digital Outputs ~ 7 pF

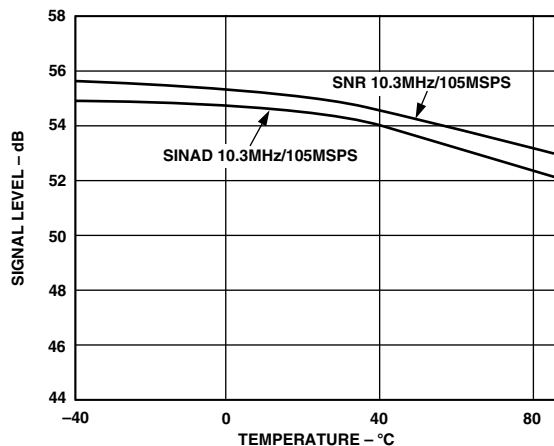

TPC 13. SINAD/SNR vs. Temperature ($f_{AIN} = 10.3 \text{ MHz}$, $f_{ENCODE} = 105 \text{ MSPS}$, 1 V p-p)

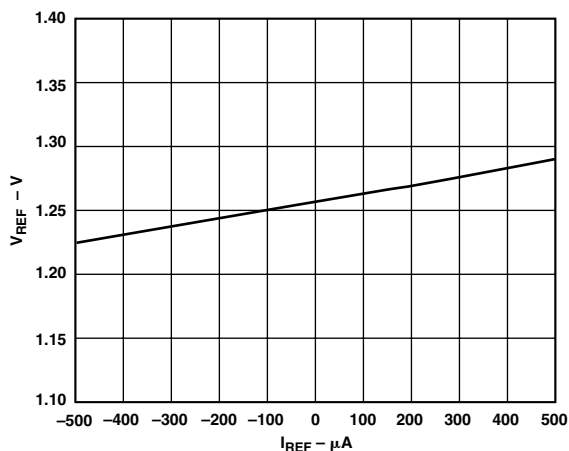

TPC 16. ADC Reference vs. Current Load

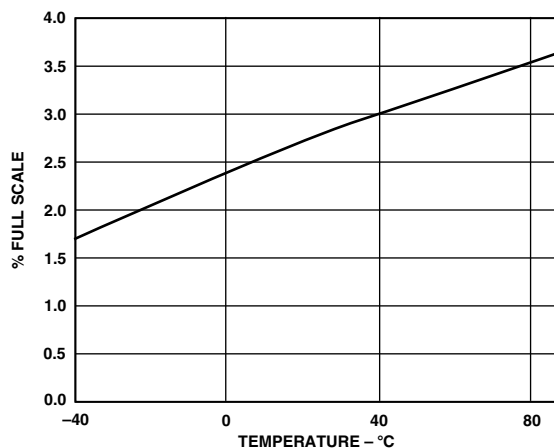

TPC 14. ADC Gain vs. Temperature (with External 1.25 V Reference)

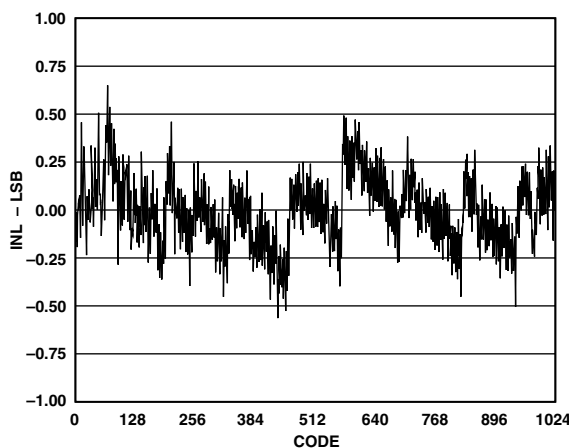

TPC 17. INL @ 80 MSPS

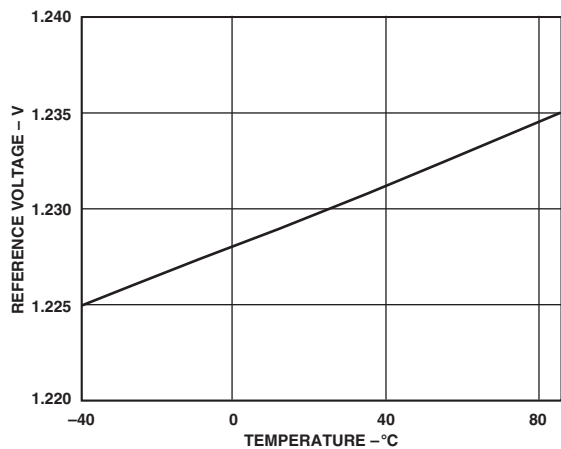

TPC 15. ADC Reference vs. Temperature (with $200 \mu\text{A}$ Load)

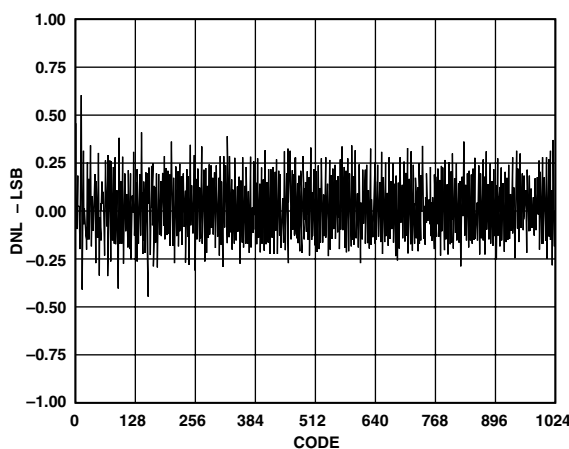

TPC 18. DNL @ 80 MSPS

AD9214

THEORY OF OPERATION

The AD9214 architecture is a bit-per-stage pipeline converter utilizing switch capacitor techniques. These stages determine the 7 MSBs and drive a 3-bit flash. Each stage provides sufficient overlap and error correction allowing optimization of comparator accuracy. The input buffer is differential and both inputs are internally biased. This allows the most flexible use of ac or dc and differential or single-ended input modes. The output staging block aligns the data, carries out the error correction and feeds the data to output buffers. The output buffers are powered from a separate supply, allowing support of different logic families. During power-down, the outputs go to a high impedance state.

APPLYING THE AD9214

Encoding the AD9214

Any high-speed A/D converter is extremely sensitive to the quality of the sampling clock provided by the user. A Track/ Hold circuit is essentially a mixer. Any noise, distortion, or timing jitter on the clock will be combined with the desired signal at the A/D output. For that reason, considerable care has been taken in the design of the ENCODE input of the AD9214, and the user is advised to give commensurate thought to the clock source. The ENCODE input is fully TTL/CMOS compatible, and should normally be driven directly from a low jitter, crystal-controlled TTL/CMOS oscillator.

The ENCODE input is internally biased, allowing the user to ac-couple in the clock signal. The cleanest clock source is often a crystal oscillator producing a pure sine wave. Figure 7 illustrates ac coupling such a source to the ENCODE input.

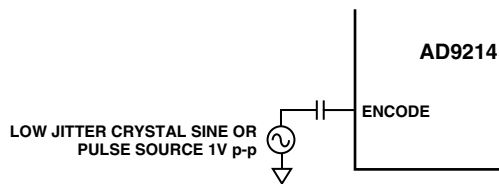

Figure 7. AC-Coupled Encode Circuit

Reference Circuit

The reference circuit of the AD9214 is configured by REFSENSE (Pin 3). By externally connecting REFSENSE to AGND, the ADC is configured to use the internal reference (~ 1.25 V), and the REF pin connection (Pin 4) is configured as an output for the internal reference voltage.

If REFSENSE is externally connected to AV_{DD} , the ADC is configured to use an external reference. In this mode, the REF pin is configured as a reference input, and must be driven by an external 1.25 V reference.

In either configuration, the analog input voltage range (either 1 V p-p or 2 V p-p as determined by DFS/Gain) will track the reference voltage linearly, and an external bypass capacitor should be connected between REF and AGND to reduce noise on the reference. In practice, no appreciable degradation in performance occurs when an external reference is adjusted $\pm 5\%$.

DFS/GAIN

The DFS/GAIN (Data Format Select/Gain) input (Pin 2) controls both the output data format and gain (analog input voltage range) of the ADC. The table below describes its operation.

Table I. Data Format and Gain Configuration

External DFS/GAIN Connection	Differential Analog Input Voltage Range	Output Data Format
AGND	1 V p-p	Offset Binary
AV_{DD}	1 V p-p	Two's Complement
REF	2 V p-p	Two's Complement
Floating	2 V p-p	Offset Binary

Driving the Analog Inputs

The analog input to the AD9214 is a differential buffer. As shown in the equivalent circuits, each of the differential inputs is internally dc biased at $\sim AV_{DD}/3$ to allow ac-coupling of the analog input signal. The analog signal may be dc-coupled as well. In this case, the dc load will be equivalent to ~ 10 k Ω to $AV_{DD}/3$, and the dc common-mode level of the analog signals should be within the range of $AV_{DD}/3 \pm 200$ mV. For best dynamic performance, impedances at A_{IN} and \overline{A}_{IN} should match.

Driving the analog input differentially optimizes ac performance, minimizing even order harmonics and taking advantage of common-mode rejection of noise. A differential signal may be transformer-coupled, as illustrated in Figure 8, or driven from a high-performance differential amplifier such as the AD8138 illustrated in Figure 9.

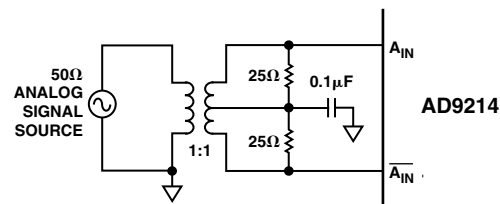

Figure 8. Single-Ended-to-Differential Conversion Using a Transformer

Special care was taken in the design of the analog input section of the AD9214 to prevent damage and corruption of data when the input is overdriven. The optimal input range is 1.0 V p-p, but the AD9214 can support a 2.0 V p-p input range with some degradation in performance (see DFS/GAIN pin description above).

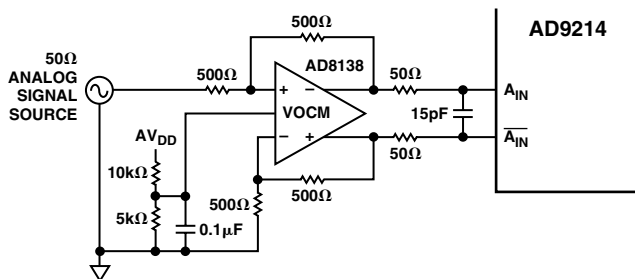

Figure 9. DC-Coupled Analog Input Circuit

POWER SUPPLIES

The AD9214 has two power supplies, AV_{DD} and DrV_{DD} . AV_{DD} and AGND supply power to all the analog circuitry, the inputs and the internal timing and digital error correction circuits. AV_{DD} supply current will vary slightly with encode rate, as noted in the Typical Performance Characteristics section.

DrV_{DD} and DGND supply only the CMOS digital outputs, allowing the user to adjust the voltage level to match downstream logic.

DrV_{DD} current will vary depending on the voltage level, external loading capacitance, and the encode frequency. Designs that minimize external load capacitance will reduce power consumption and reduce supply noise that may affect ADC performance. The maximum DrV_{DD} current can be calculated as

$$I_{DrV_{DD}} = V_{DrV_{DD}} \times C_{LOAD} \times f_{encode} \times N$$

where N is the number of output bits, 10 in the case of the AD9214. This maximum current is for the condition of every output bit switching on every clock cycle, which can only occur for a full scale square wave at the Nyquist frequency, $f_{ENCODE}/2$. In practice, $I_{DrV_{DD}}$ will be the average number of output bits switching, which will be determined by the encode rate and the characteristics of the analog input signal. The performance curves section provides a reference of $I_{DrV_{DD}}$ versus encode rate for a 10.3 MHz sine wave driving the analog input.

Both power supply connections should be decoupled to ground at or near the package connections, using high quality, ceramic chip capacitors. A single ground plane is recommended for all ground (AGND and DGND) connections.

The PWRDN control pin configures the AD9214 for a sleep mode when it is logic HIGH. PWRDN floats logic LOW for normal operation. In sleep mode, the ADC is not active, and will consume less power. When switching from sleep mode to normal operation, the ADC will need ~15 clock cycles to recover to valid output data.

Digital Outputs

Care must be taken when designing the data receivers for the AD9214. It is recommended that the digital outputs drive a series resistor (e.g., 100 Ω) followed by a gate like the 74LCX821. To minimize capacitive loading, there should be only one gate on each output pin. An example of this is shown in the evaluation board schematic in Figure 10. The series resistors should be placed as close to the AD9214 as possible to limit the amount of current that can flow into the output stage. These switching currents are confined between ground (DGND) and the DrV_{DD} pins. Standard TTL gates should be avoided since they can appreciably add to the dynamic switching currents of the AD9214.

It should also be noted that extra capacitive loading will increase output timing and invalidate timing specifications. Digital output timing is guaranteed with 10 pF loads.

LAYOUT INFORMATION

The schematic of the evaluation board (Figure 10) represents a typical implementation of the AD9214. A multilayer board is recommended to achieve best results. It is highly recommended that high quality, ceramic chip capacitors be used to decouple each supply pin to ground directly at the device. The pinout of the AD9214 facilitates ease of use in the implementation of high frequency, high resolution design practices. All of the digital outputs and their supply and ground pin connections are segregated to one side of the package, with the inputs on the opposite side for isolation purposes.

Care should be taken when routing the digital output traces. To prevent coupling through the digital outputs into the analog portion of the AD9214, minimal capacitive loading should be placed on these outputs. It is recommended that a fan-out of only one gate should be used for all AD9214 digital outputs.

The layout of the encode circuit is equally critical. Any noise received on this circuitry will result in corruption in the digitization process and lower overall performance. The Encode clock must be isolated from the digital outputs and the analog inputs.

EVALUATION BOARD

The AD9214 evaluation board offers designers an easy way to evaluate device performance. The user must supply an analog input signal, encode clock reference, and power supplies. The digital outputs of the AD9214 are latched on the evaluation board, and are available with a data ready signal at a 40-pin edge connector. Please refer to the evaluation board schematic, layout, and Bill of Materials.

Power Connections

Power to the board is supplied via three detachable, 4-pin power strips (U4, U9, and U10). These 12 pins should be driven as outlined in the Table II.

Table II. Power Supply Connections for AD9214 Evaluation Board

Pin	Designator	External Supply Required
1	LVC	3 V
3	+5 V	+5 V (Optional Z1 Supply)
5	-5 V	-5 V (Optional Z1 Supply)
7	VCC	3 V
9	VDD	3 V
11	DAC	5 V
2, 4, 6, 8, 10, 12	GND	Ground

Please note that the +5 V and -5 V supplies are optional, and only required if the user adds differential op amp Z1 to the board.

AD9214

Reference Circuit

The evaluation board is configured at assembly to use the AD9214's on-board reference. To supply an external reference, the user must connect the REFSENSE pin to VCC by removing the jumper block connecting E25 to E26, and placing it between E19 and E24. In this configuration, an external 1.25 V reference must be connected to jumper connection E23. Jumper connections E19–E21, E24, and resistors R13–R14 are omitted at assembly, and not used in the evaluation of the AD9214.

Gain/Data Format

The evaluation board is assembled with the DFS/GAIN pin connected to ground; this configures the AD9214 for a 1 V p-p analog input range, and offset binary data format. The user may remove this jumper and replace it to make *one* of the connections described in the table below to configure the AD9214 for different gain and output data format options.

Table III. Data Format and Gain Configuration for Evaluation Board

DFS/GAIN Jumper Placement	DFS/GAIN Connection	Differential A_{IN} Range	Output Data Format
E18 to E12	AGND	1 V p-p	Offset Binary
E16 to E11	AV_{DD}	1 V p-p	Two's Complement
E15 to E14	REF	2 V p-p	Two's Complement
E17 to E13	Floating	2 V p-p	Offset Binary

Power-Down

The evaluation board is configured at assembly so that the PWRDN input floats low for normal operating condition. The user may add a jumper between option holes E5 and E6 to connect PWRDN to AVCC, configuring the AD9214 for power-down mode.

Encode Signal and Distribution

The encode input signal should drive SMB connector J5, which has an on-board 50 Ω termination. A standard CMOS compatible pulse source is recommended. Alternatively, the user can adjust the dc level of an ac-coupled clock source by adding resistor R11, normally omitted. J5 drives the AD9214 ENCODE input and one gate of U12, which buffers and distributes the clock signal to the on-board latch (U3), the reconstruction DAC (U11), and the output data connector (U2). The board comes assembled with timing options optimized for the DAC and latch; the user may invert the DR signal at Pin 37 of edge connector U2 by removing the jumper block between E34 and E35, and reinstalling it between E35 and E36.

Analog Input

The analog input signal is connected to the evaluation board by SMB connector J1. As configured at assembly, the signal is ac coupled by capacitor C10 to transformer T1. This 1:1 transformer provides a 50 Ω termination for connector J1 via 25 Ω resistors R1 and R4. T1 also converts the signal at J1 into a differential signal for the analog inputs of the AD9214. Resistor R3, normally omitted, can be used to terminate J1 if the transformer is removed.

The user can reconfigure the board to drive the AD9214 single-endedly by removing the jumper block between E1 and E3, and replacing it between E3 and E2. In this configuration, capacitor C2 stabilizes the self-bias of \overline{A}_{IN} , and resistor R2 provides a matched impedance for a 50 Ω source at J1.

Transformer T1 can be bypassed by moving the jumper normally between E40 and E38 to connect E40 to E37, and moving the jumper normally between E39 and E10 to connect E7 to E10. In this configuration, the analog input of the AD9214 is driven single ended, directly from J1; and R3 (normally omitted) should be installed to terminate any cable connected to J1.

Using the AD8138

An optional driver circuit for the analog input, based on the AD8138 differential amplifier, is included in the layout of the AD9214 evaluation board. This portion of the evaluation circuit is not populated when the board is manufactured, but can be easily be added by the user. Resistors R5, R16, R18, and R25 are the feedback network that sets the gain of the AD8138. Resistors R23 and R24 set the common-mode voltage at the output of the op amp. Resistors R27 and R28, and capacitor C15, form a low-pass filter at the output of the AD8138, limiting its noise contribution into the AD9214.

Once the drive circuit is populated, the user should remove the jumper block normally between E40 and E38, and place it between E40 and E41. This will ac-couple the analog input signal from SMB connector J1 to the AD8138 drive circuit. The user will also need to remove the jumper blocks that normally connect E39 to E10 and E1 to E3 to remove transformer T1 from the circuit.

DAC Reconstruction Circuit

The data available at output connector U2 is also reconstructed by DAC U11, the AD9752. This 12-bit, high-speed digital-to-analog converter is included as a tool in setting up and debugging the evaluation board. It should not be used to measure the performance of the AD9214, as its performance will not accurately reflect the performance of the ADC. The DAC's output, available at J2, will drive 50 Ω . The user can add a jumper block between E8 and E9 to activate the SLEEP function of the DAC.

AD9214/PCB Bill of Material

#	Quantity	Reference Designator	Device	Package	Value
1	1	N/A	PCB		
2	19	C1-C3, C5-C14, C16-C20, C25-C28	Capacitor	603	0.1 μ F
3	4	C21-C24	Capacitor	CAPTAJD	10 μ F
4	1	C4	Capacitor	603	0.01 μ F
5	4	R1, R2, R4, R8	Resistor	1206	25 Ω
6	4	R7, R10, R12, R17	Resistor	1206	50 Ω
7	4	U5-U8	Resistor	RPAK_742	100 Ω
8	1	R21	Resistor	1206	0 Ω
9	2	R6, R9	Resistor	1206	2000 Ω
10	37	E1-E6, E8-E9, E11-E27, E29, E31-E41	Test Points Jumper Connections		TSW-120-07-G-S SMT-100-BK-G
11	3	J1, J2, J5	Connector	SMB	51-52-220
12	1	U12	Clock Chip	SOIC	SN74LVC86
13	1	U11	DAC	SOIC	AD9752
14	1	U3	Latch	SOIC	74LCX821
15	1	U1	ADC/DUT	SOIC	AD9214
16	1	U2	40-Pin Header		Samtec TSW-120-07-G-D
17	1	T1	Transformer		Mini Circuits ADT1-1WT
18	3	U4, U9, U10	Power Strip Power Connector		Newark 95F5966 25.602.5453.0

The following items are included in the PCB design, but are omitted at assembly.

19	3	C1, C20, C28	Capacitor	603	0.1 μ F
20	2	C30, C29	Capacitor	CAPTAJD	10 μ F
21	1	C15	Capacitor	603	15 pF
22	4	R5, R18, R25, R26	Resistor	1206	500 Ω
23	1	R23	Resistor	1206	1 k Ω
24	1	R24	Resistor	1206	4 k Ω
25	3	R11, R15, R16	Resistor	1206	User Select
26	2	R13, R14	Resistor	1206	N/A
27	3	R27, R28, R3	Resistor	1206	50 Ω
28	1	R19	Resistor	1206	0 Ω
29	1	Z1	Op Amp	SOIC	AD8138

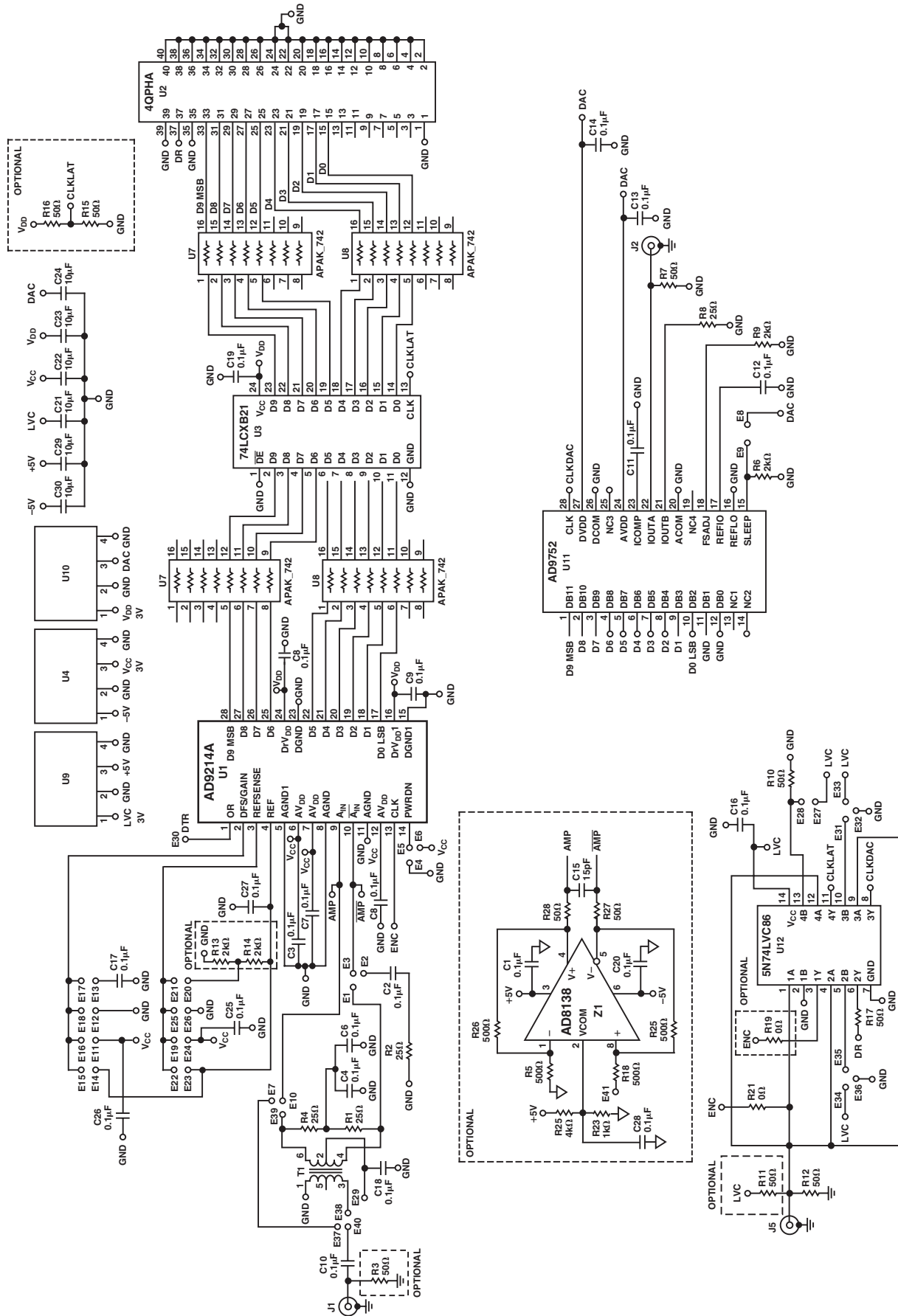

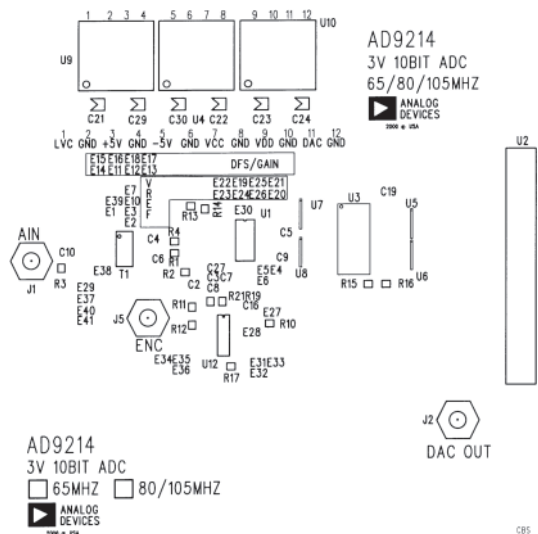

Figure 11. PCB Top Side Silkscreen

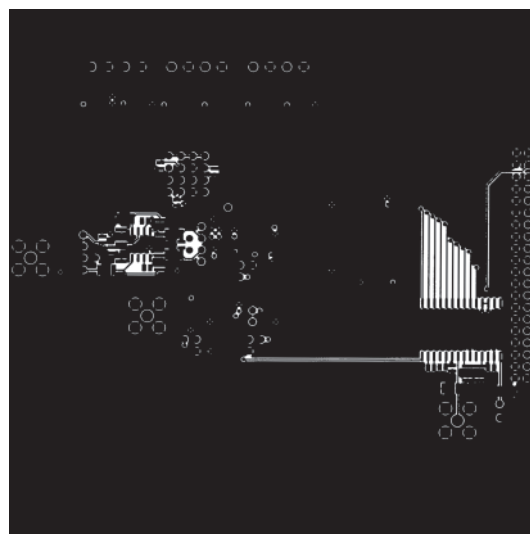

Figure 14. PCB Bottom Side Copper

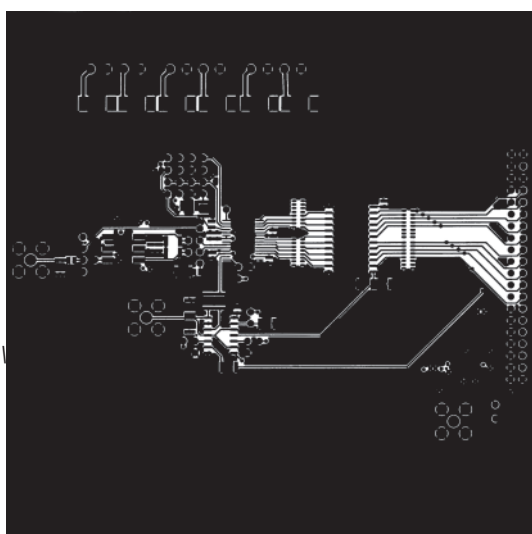

Figure 12. PCB Top Side Copper

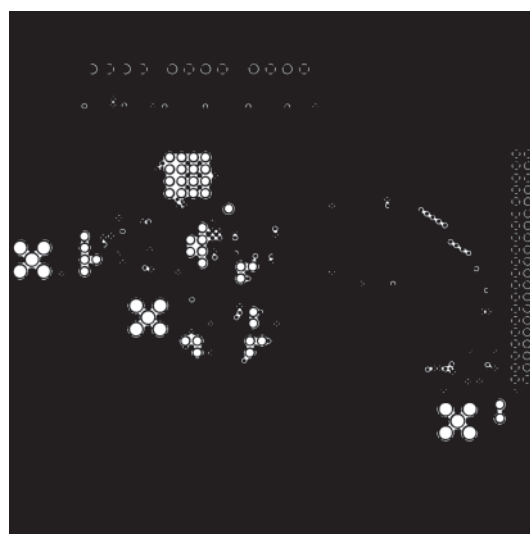

Figure 15. PCB Ground Layer—Layer TBD

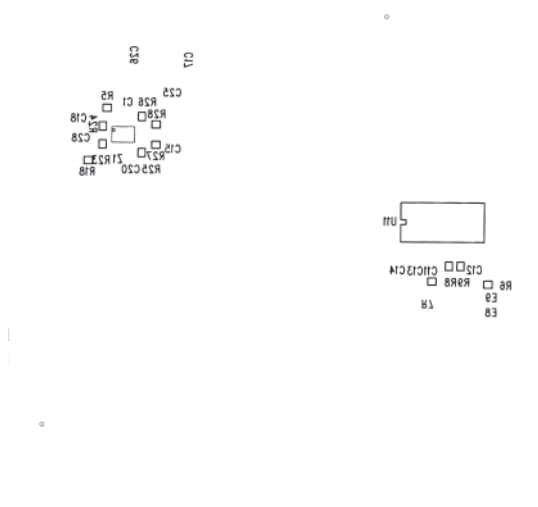

Figure 13. PCB Bottom Side Silkscreen

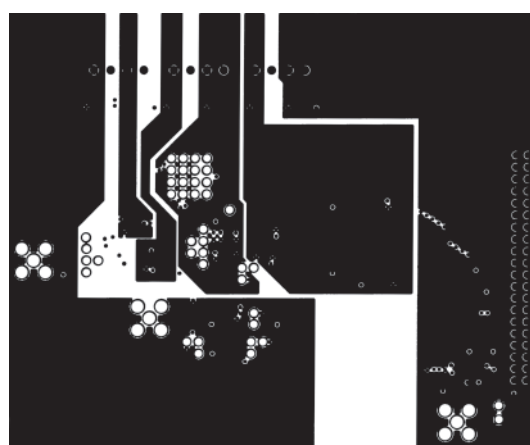
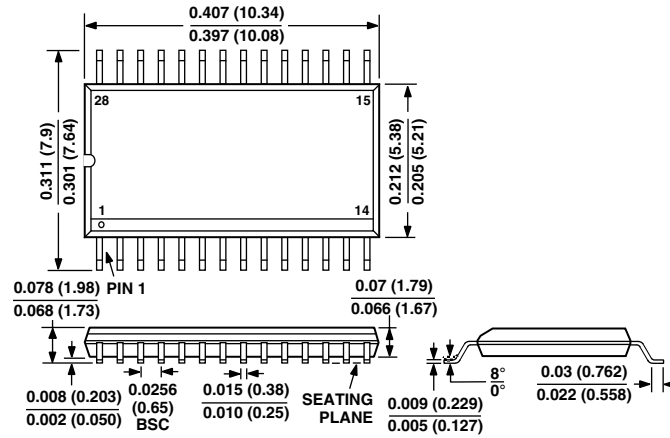

Figure 16. PCB Power Layers—Layers 3 and 4

OUTLINE DIMENSIONS

Dimensions shown in inches and (mm).

28-Lead Shrink Small Outline Package (RS-28)



CONTROLLING DIMENSIONS ARE IN MILLIMETERS; INCH DIMENSIONS ARE ROUNDED-OFF MILLIMETER EQUIVALENTS FOR REFERENCE ONLY AND ARE NOT APPROPRIATE FOR USE IN DESIGN

Revision History

Location	Page
Data Sheet changed from REV. C to REV. D.	
Edit to Functional Block Diagram	1
TPC 15 replaced with new figure	11
Edit to Figure 10	16
07/01—Data Sheet changed from REV. B to REV. C.	
Edit to ABSOLUTE MAXIMUM RATINGS	5
05/01—Data Sheet changed from REV. A to REV. B.	
Changes to PSRR Specifications in AD9214-65, AD9214-80, AD9214-105 Columns	2
Change to SNR Specifications in AD9214-105 Column	3
Changes to THIRD HARMONIC DISTORTION Specifications in AD9214-105 Column	3
01/01—Data Sheet changed from REV. 0 to REV. A.	
Changes to DC Specifications in AD9214-65, AD9214-80, AD9214-105 Columns	2
Changes to AC Specifications in AD9214-65, AD9214-105 Columns	3

Looking for pricing, stock, or lifecycle information?

Click below to explore more details on WIN SOURCE:

 [View AD9214BRSZ-105 on WIN SOURCE](#)

 [Analog Devices Inc. Information](#)

Optimize Your Supply Chain with WIN SOURCE Solutions

-  Global Sourcing Solution
-  Obsolete Management
-  Cost Control Management
-  Shortage Management
-  Alternative Solution
-  Excess Inventory Management