



**THE DATASHEET OF  
IXFH12N100**



# HiPerFET™ Power MOSFETs

N-Channel Enhancement Mode  
High dv/dt, Low  $t_{rr}$ , HDMOS™ Family

**IXFH/IXFM 10 N100**  
**IXFH/IXFM 12 N100**

$V_{DSS}$	$I_{D25}$	$R_{DS(on)}$
<b>1000 V</b>	<b>10 A</b>	<b>1.20 <math>\Omega</math></b>
<b>1000 V</b>	<b>12 A</b>	<b>1.05 <math>\Omega</math></b>

**$t_{rr} \leq 250$  ns**

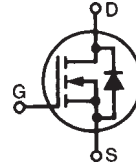

Symbol	Test Conditions	Maximum Ratings		
$V_{DSS}$	$T_J = 25^\circ\text{C}$ to $150^\circ\text{C}$	1000	V	
$V_{DGR}$	$T_J = 25^\circ\text{C}$ to $150^\circ\text{C}$ ; $R_{GS} = 1$ M $\Omega$	1000	V	
$V_{GS}$	Continuous	$\pm 20$	V	
$V_{GSM}$	Transient	$\pm 30$	V	
$I_{D25}$	$T_C = 25^\circ\text{C}$	10N100	10	A
		12N100	12	A
$I_{DM}$	$T_C = 25^\circ\text{C}$ , pulse width limited by $T_{JM}$	10N100	40	A
		12N100	48	A
$I_{AR}$	$T_C = 25^\circ\text{C}$	10N100	10	A
		12N100	12	A
$E_{AR}$	$T_C = 25^\circ\text{C}$	30	mJ	
dv/dt	$I_S \leq I_{DM}$ , di/dt $\leq 100$ A/ $\mu\text{s}$ , $V_{DD} \leq V_{DSS}$ , $T_J \leq 150^\circ\text{C}$ , $R_G = 2$ $\Omega$	5	V/ns	
$P_D$	$T_C = 25^\circ\text{C}$	300	W	
$T_J$		-55 ... +150	$^\circ\text{C}$	
$T_{JM}$		150	$^\circ\text{C}$	
$T_{stg}$		-55 ... +150	$^\circ\text{C}$	
$T_L$	1.6 mm (0.062 in.) from case for 10 s	300	$^\circ\text{C}$	
$M_d$	Mounting torque	1.13/10	Nm/lb.in.	
<b>Weight</b>		TO-204 = 18 g, TO-247 = 6 g		

TO-247 AD (IXFH)

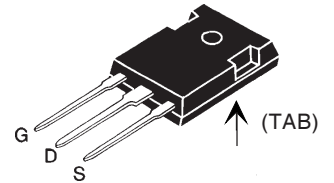

TO-204 AA (IXFM)

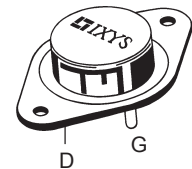

G = Gate, D = Drain,  
S = Source, TAB = Drain

### Features

- International standard packages
- Low  $R_{DS(on)}$  HDMOS™ process
- Rugged polysilicon gate cell structure
- Unclamped Inductive Switching (UIS) rated
- Low package inductance
  - easy to drive and to protect
- Fast intrinsic Rectifier

### Applications

- DC-DC converters
- Synchronous rectification
- Battery chargers
- Switched-mode and resonant-mode power supplies
- DC choppers
- AC motor control
- Temperature and lighting controls
- Low voltage relays

### Advantages

- Easy to mount with 1 screw (TO-247) (isolated mounting screw hole)
- Space savings
- High power density

Symbol	Test Conditions	Characteristic Values ( $T_J = 25^\circ\text{C}$ , unless otherwise specified)		
		min.	typ.	max.
$V_{DSS}$	$V_{GS} = 0$ V, $I_D = 3$ mA	1000		V
$V_{GS(th)}$	$V_{DS} = V_{GS}$ , $I_D = 4$ mA	2.0		4.5 V
$I_{GSS}$	$V_{GS} = \pm 20$ V <sub>DC</sub> , $V_{DS} = 0$			$\pm 100$ nA
$I_{DSS}$	$V_{DS} = 0.8 \cdot V_{DSS}$ $V_{GS} = 0$ V	$T_J = 25^\circ\text{C}$		250 $\mu\text{A}$
		$T_J = 125^\circ\text{C}$		1 mA
$R_{DS(on)}$	$V_{GS} = 10$ V, $I_D = 0.5 \cdot I_{D25}$  Pulse test, $t \leq 300$ $\mu\text{s}$ , duty cycle $d \leq 2$ %	10N100		1.20 $\Omega$
		12N100		1.05 $\Omega$

Symbol	Test Conditions	Characteristic Values ( $T_J = 25^\circ\text{C}$ , unless otherwise specified)		
		min.	typ.	max.
$g_{fs}$	$V_{DS} = 10\text{ V}; I_D = 0.5 \cdot I_{D25}$ , pulse test	6	10	S
$C_{iss}$	$V_{GS} = 0\text{ V}, V_{DS} = 25\text{ V}, f = 1\text{ MHz}$		4000	pF
$C_{oss}$			310	pF
$C_{rss}$			70	pF
$t_{d(on)}$	$V_{GS} = 10\text{ V}, V_{DS} = 0.5 \cdot V_{DSS}, I_D = 0.5 \cdot I_{D25}$ $R_G = 2\ \Omega$ (External),		21	50 ns
$t_r$			33	50 ns
$t_{d(off)}$			62	100 ns
$t_f$			32	50 ns
$Q_{g(on)}$	$V_{GS} = 10\text{ V}, V_{DS} = 0.5 \cdot V_{DSS}, I_D = 0.5 \cdot I_{D25}$		122	155 nC
$Q_{gs}$			30	45 nC
$Q_{gd}$			50	80 nC
$R_{thJC}$			0.25	0.42 K/W
$R_{thCK}$				K/W

Source-Drain Diode		Characteristic Values ( $T_J = 25^\circ\text{C}$ , unless otherwise specified)		
Symbol	Test Conditions	min.	typ.	max.
$I_S$	$V_{GS} = 0\text{ V}$	10N100 12N100 13N100		10 A 12 A 12.5 A
$I_{SM}$	Repetitive; pulse width limited by $T_{JM}$	10N100 12N100 13N100		40 A 48 A 50 A
$V_{SD}$	$I_F = I_S, V_{GS} = 0\text{ V}$ , Pulse test, $t \leq 300\ \mu\text{s}$ , duty cycle $d \leq 2\%$			1.5 V
$t_{rr}$	$I_F = I_S$ $-di/dt = 100\text{ A}/\mu\text{s}$ , $V_R = 100\text{ V}$	$T_J = 25^\circ\text{C}$ $T_J = 125^\circ\text{C}$		250 ns
$Q_{RM}$				$T_J = 25^\circ\text{C}$ $T_J = 125^\circ\text{C}$
$I_{RM}$		$T_J = 25^\circ\text{C}$ $T_J = 125^\circ\text{C}$		10 A 15 A

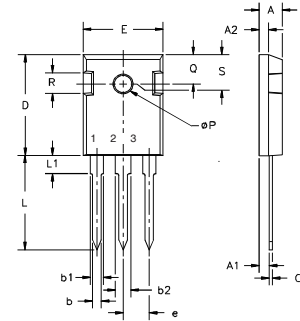
**TO-247 AD (IXFH) Outline**

 Terminals: 1 - Gate 2 - Drain  
 3 - Source Tab - Drain

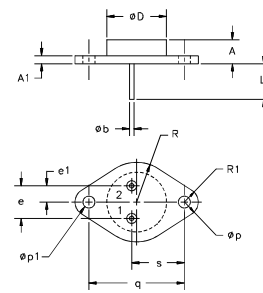
Dim.	Millimeter		Inches	
	Min.	Max.	Min.	Max.
A	4.7	5.3	.185	.209
A <sub>1</sub>	2.2	2.54	.087	.102
A <sub>2</sub>	2.2	2.6	.059	.098
b	1.0	1.4	.040	.055
b <sub>1</sub>	1.65	2.13	.065	.084
b <sub>2</sub>	2.87	3.12	.113	.123
C	.4	.8	.016	.031
D	20.80	21.46	.819	.845
E	15.75	16.26	.610	.640
e	5.20	5.72	0.205	0.225
L	19.81	20.32	.780	.800
L1		4.50		.177
∅P	3.55	3.65	.140	.144
Q	5.89	6.40	0.232	0.252
R	4.32	5.49	.170	.216
S	6.15	BSC	242	BSC

**TO-204 AA (IXFM) Outline**

 Pins 1 - Gate 2 - Source  
 Case - Drain

Dim.	Millimeter		Inches	
	Min.	Max.	Min.	Max.
A	6.4	11.4	.250	.450
A <sub>1</sub>		3.42		.135
∅b	.97	1.09	.038	.043
∅D		22.22		.875
e	10.67	11.17	.420	.440
e <sub>1</sub>	5.21	5.71	.205	.225
L	7.93		.312	
∅p	3.84	4.19	.151	.165
∅p <sub>1</sub>	3.84	4.19	.151	.165
q	30.15	BSC	1.187	BSC
R		13.33		.525
R <sub>1</sub>		4.77		.188
s	16.64	17.14	.655	.675

IXYS reserves the right to change limits, test conditions, and dimensions.

Fig. 1 Output Characteristics

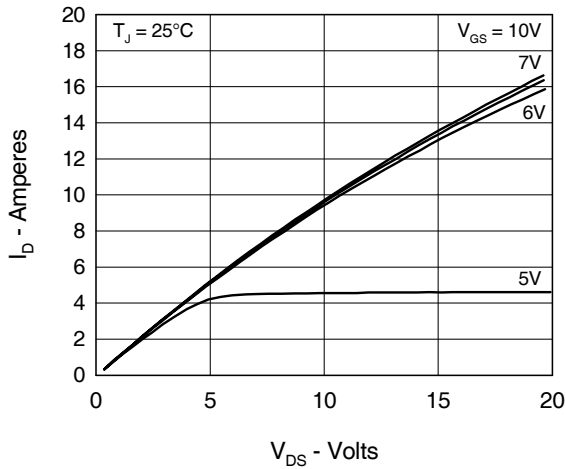

Fig. 2 Input Admittance

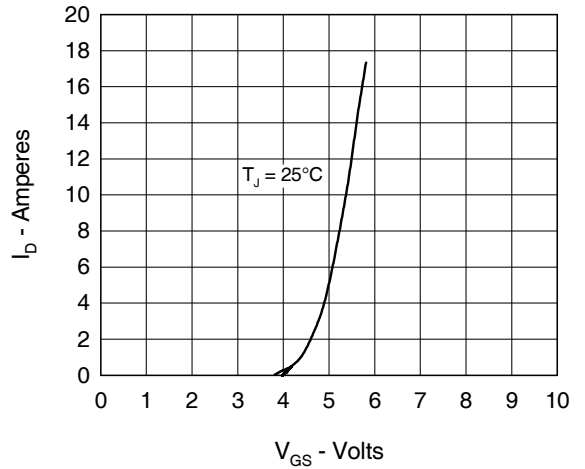

Fig. 3  $R_{DS(on)}$  vs. Drain Current

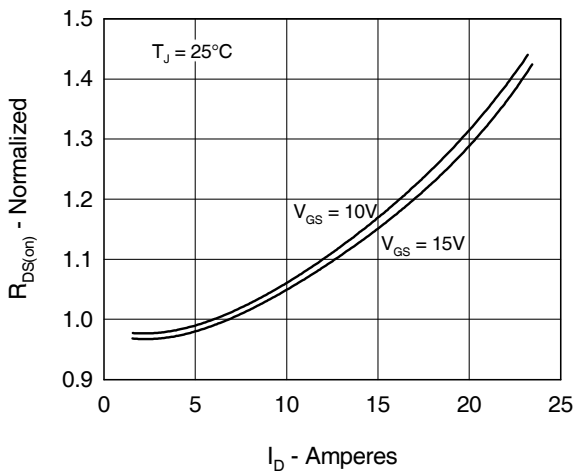

Fig. 4 Temperature Dependence of Drain to Source Resistance

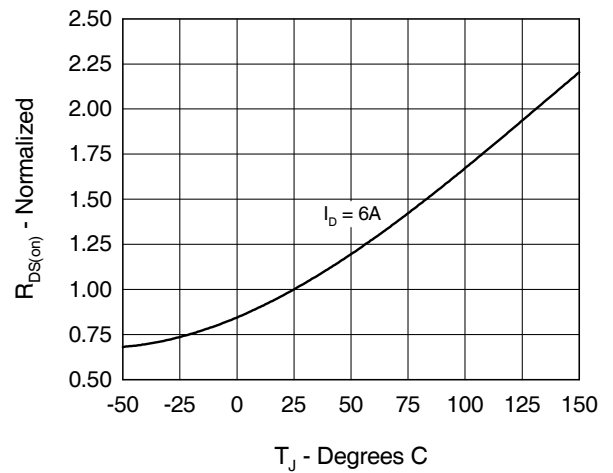

Fig. 5 Drain Current vs. Case Temperature

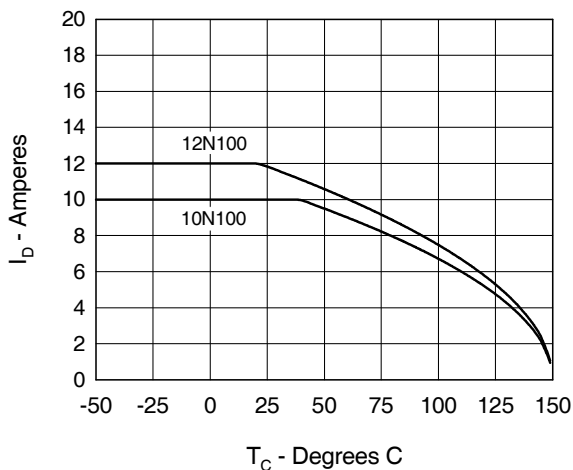

Fig. 6 Temperature Dependence of Breakdown and Threshold Voltage

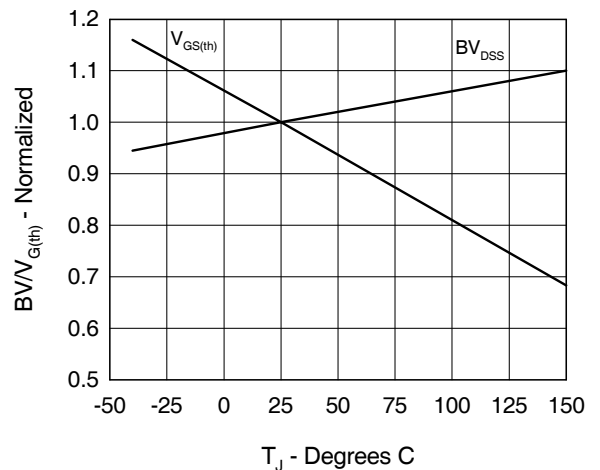

Fig.7 Gate Charge Characteristic Curve

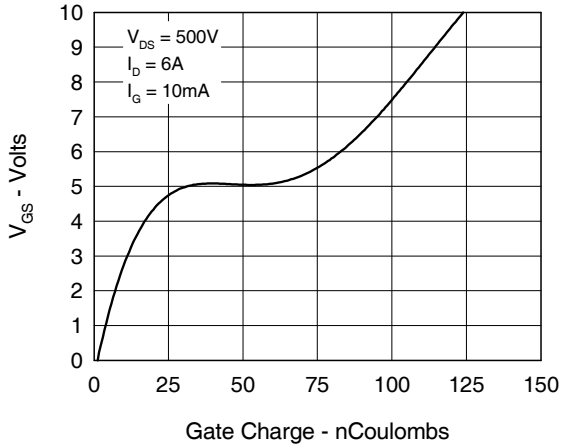

Fig.8 Capacitance Curves

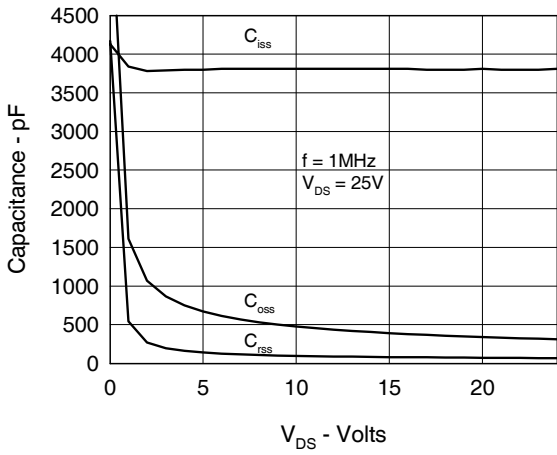

Fig.9 Source Current vs. Source to Drain Voltage

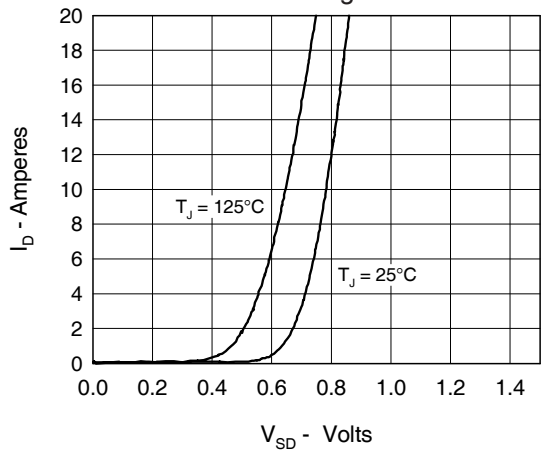
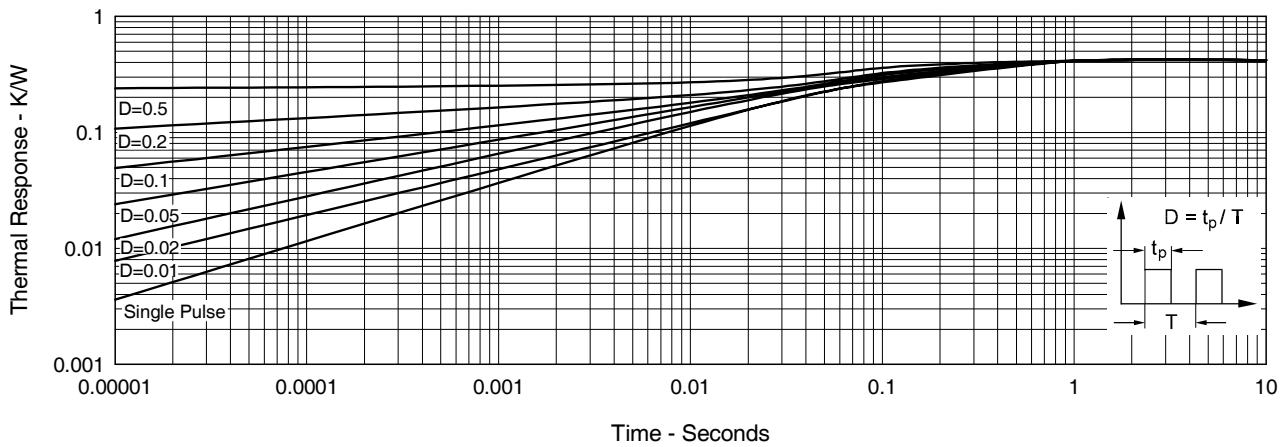

Fig.10 Transient Thermal Impedance



IXYS reserves the right to change limits, test conditions, and dimensions.





---







Disclaimer Notice - Information furnished is believed to be accurate and reliable. However, users should independently evaluate the suitability of and test each product selected for their own applications. Littelfuse products are not designed for, and may not be used in, all applications. Read complete Disclaimer Notice at [www.littelfuse.com/disclaimer-electronics](http://www.littelfuse.com/disclaimer-electronics).

## Looking for pricing, stock, or lifecycle information?

Click below to explore more details on WIN SOURCE:

-  [View IXFH12N100 on WIN SOURCE](#)
-  [IXYS Information](#)

## Optimize Your Supply Chain with WIN SOURCE Solutions

-  Global Sourcing Solution
-  Obsolete Management
-  Cost Control Management
-  Shortage Management
-  Alternative Solution
-  Excess Inventory Management