



MIC39150/39151/39152

1.5A, Low-Voltage Low-Dropout Regulator

General Description

The MIC39150, MIC39151, and MIC39152 are 1.5A LDO voltage regulators that provide a low voltage, high current output with a minimum of external components. Utilizing Micrel's proprietary Super β PNP[®] pass element, the MIC39150/1/2 offers extremely low dropout (typically 375mV at 1.5A) and low ground current (typically 17mA at 1.5A).

The MIC39150/1/2 are ideal for PC add-in cards that need to convert from 3.3V to 2.5V or 2.5V to 1.8V with a guaranteed maximum dropout voltage of 500mV over all operating conditions. The MIC39150/1/2 exhibit fast transient response for heavy switching applications and requires only 10 μ F of output capacitance to maintain stability and achieve fast transient response.

The MIC39150/1/2 is fully protected with current limiting, thermal shutdown, reversed-battery protection/lead insertion, and reverse-leakage protection. The MIC39151 offers a TTL-logic compatible enable pin and an error flag that indicates undervoltage and overcurrent conditions. Offered in fixed voltages of 2.5V, 1.8V and 1.65V, the MIC39150/1 comes in the TO-220 and TO-263 (D²Pak) packages. The MIC39152 adjustable option allows programming the output voltage anywhere between 1.24V and 15.5V and comes in 5-Pin, TO-263 (D²Pak) and TO-252 (D-Pak) packages.

For applications requiring input voltage greater than 16V or automotive load dump protection, see the MIC29150/1/2/3 family.

Features

- 1.5A minimum guaranteed output current
- 500mV maximum dropout voltage over temperature
 - Ideal for 3.0V to 2.5V conversion
 - Ideal for 2.5 to 1.8V or 1.65V conversion
- 1% initial accuracy
- Low ground current
- Current limiting and Thermal shutdown
- Reversed-battery and reversed lead insertion protection
- Reversed-leakage protection
- Fast transient response
- TTL/CMOS compatible enable pin (MIC39151/2 only)
- Error flag output (MIC39151 only)
- Adjustable output (MIC39152 only)
- Power D-Pak package (TO-252) Adjustable only
- Power D²Pak package (TO-263)

Applications

- Low-voltage digital ICs
- LDO linear regulator for PC add-in cards
- High-efficiency linear power supplies
- SMPS post regulator
- Low-voltage microcontrollers
- StrongARM[™] processor supply

Typical Application**

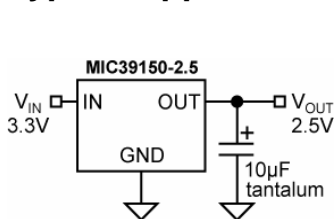

MIC39150

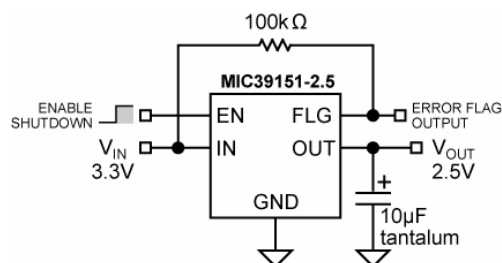

MIC39151

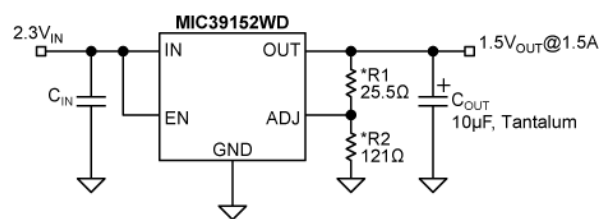

MIC39152 Adjustable Output Application
(*See Minimum Load Current Section)

Super β PNP is a registered trademark of Micrel, Inc.
StrongARM is a trademark of Advanced RSIC Machines, Ltd.

**See Thermal Design Section

Ordering Information

| Part Number | | Voltage | Junction Temp. Range | Package |
|-----------------|-----------------|------------|----------------------|--------------|
| Standard | RoHS Compliant* | | | |
| MIC39150-1.65BT | MIC39150-1.65WT | 1.65V | -40° to +125°C | 3-Pin TO-220 |
| MIC39150-1.65BU | MIC39150-1.65WU | 1.65V | -40° to +125°C | 3-Pin TO-263 |
| MIC39150-1.8BT | MIC39150-1.8WT | 1.8V | -40° to +125°C | 3-Pin TO-220 |
| MIC39150-1.8BU | MIC39150-1.8WU | 1.8V | -40° to +125°C | 3-Pin TO-263 |
| MIC39150-2.5BT | MIC39150-2.5WT | 2.5V | -40° to +125°C | 3-Pin TO-220 |
| MIC39150-2.5BU | MIC39150-2.5WU | 2.5V | -40° to +125°C | 3-Pin TO-263 |
| MIC39151-1.65BT | MIC39151-1.65WT | 1.65V | -40° to +125°C | 5-Pin TO-220 |
| MIC39151-1.65BU | MIC39151-1.65WU | 1.65V | -40° to +125°C | 5-Pin TO-263 |
| MIC39151-1.8BT | MIC39151-1.8WT | 1.8V | -40° to +125°C | 5-Pin TO-220 |
| MIC39151-1.8BU | MIC39151-1.8WU | 1.8V | -40° to +125°C | 5-Pin TO-263 |
| MIC39151-2.5BT | MIC39151-2.5WT | 2.5V | -40° to +125°C | 5-Pin TO-220 |
| MIC39151-2.5BU | MIC39151-2.5WU | 2.5V | -40° to +125°C | 5-Pin TO-263 |
| — | MIC39152WU | Adjustable | -40° to +125°C | 5-Pin TO-263 |
| — | MIC39152WD | Adjustable | -40° to +125°C | 5-Pin TO-252 |

Note:

* RoHS compliant with 'high-melting solder' exemption.

Pin Configuration

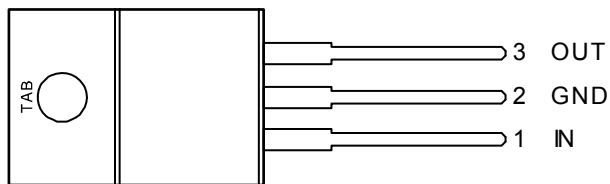

**MIC39150-x.xBT/WT
TO-220-3 (T)**

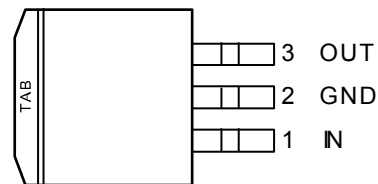

**MIC39150-x.xBU/WU
TO-263-3 (U)**

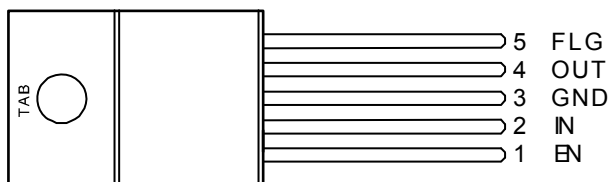

**MIC39151-x.xBT/WT
TO-220-5 (T)**

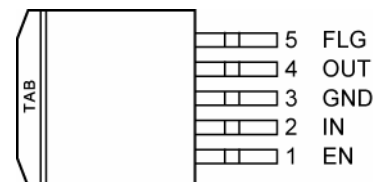

**MIC39151-x.xBU/WU
TO-263-5 (D²Pak) (U)**

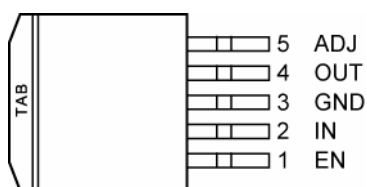

**MIC39152WU
TO-263-5 (D²Pak) (U)**



**MIC39152WD
TO-252-5 (D-Pak) (D)**

Pin Description

| Pin Number MIC39150 | Pin Number MIC39151 | Pin Number MIC39152 | Pin Name | Pin Description |
|------------------------|------------------------|------------------------|----------|---|
| — | 1 | 1 | EN | Enable (Input): TTL/CMOS compatible input. Logic high = enable; logic low or open = shutdown. |
| 1 | 2 | 2 | IN | Unregulated Input: +16V maximum supply. |
| 2, TAB | 3, TAB | 3, TAB | GND | Ground: Ground pin and TAB are internally connected. |
| 3 | 4 | 4 | OUT | Regulator Output. |
| — | 5 | — | FLG | Error Flag (Output): Open-collector output. Active low indicates an output fault condition. |
| — | — | 5 | ADJ | Adjustable Regulator Feedback Input: Connect to the resistor voltage divider that is placed from OUT to GND in order to set the output voltage. |

Absolute Maximum Ratings⁽¹⁾

| | |
|---|-----------------|
| Supply Voltage (V_{IN})..... | -20V to +20V |
| Enable Voltage (V_{EN})..... | +20V |
| Storage Temperature (T_s) | -60°C to +150°C |
| Lead Temperature (soldering, 5 sec.)..... | 260°C |
| ESD Rating..... | Note 3 |

Operating Ratings⁽²⁾

| | |
|--|-----------------|
| Supply Voltage (V_{IN})..... | +2.25V to +16V |
| Enable Voltage (V_{EN})..... | +16V |
| Maximum Power Dissipation ($P_{D(max)}$) | Note 4 |
| Junction Temperature (T_J) | -40°C to +125°C |
| Package Thermal Resistance | |
| TO-263 (θ_{JC}) | 2°C/W |
| TO-220 (θ_{JC}) | 2°C/W |
| TO-252 (θ_{JC}) | 3°C/W |
| TO-252 (θ_{JA}) | 56°C/W |

Electrical Characteristics⁽⁵⁾

$V_{IN} = V_{EN} = V_{OUT} + 1V$; $I_{OUT} = 10mA$; $T_J = 25^\circ C$, **bold** values indicate $-40^\circ C \leq T_J \leq +125^\circ C$, unless noted.

| Symbol | Parameter | Condition | Min | Typ | Max | Units |
|---------------------------|---|---|-----|------|-----|---------|
| V_{OUT} | Output Voltage | 10mA | -1 | | 1 | % |
| | | $10mA \leq I_{OUT} \leq 1.5A, V_{OUT} + 1V \leq V_{IN} \leq 8V$ | -2 | | 2 | % |
| | Line Regulation | $I_{OUT} = 10mA, V_{OUT} + 1V \leq V_{IN} \leq 16V$ | | 0.06 | 0.5 | % |
| | Load Regulation | $V_{IN} = V_{OUT} + 1V, 10mA \leq I_{OUT} \leq 1.5A$ | | 0.2 | 1 | % |
| $\Delta V_{OUT}/\Delta T$ | Output Voltage Temp. Coefficient, Note 6 | | | 20 | 100 | ppm/°C |
| V_{DO} | Dropout Voltage, Note 7 | $I_{OUT} = 100mA, \Delta V_{OUT} = -1\%$ | | 80 | 200 | mV |
| | | $I_{OUT} = 750mA, \Delta V_{OUT} = -1\%$ | | 260 | | mV |
| | | $I_{OUT} = 1.5A, \Delta V_{OUT} = -1\%$ | | 375 | 500 | mV |
| I_{GND} | Ground Current, Note 8 | $I_{OUT} = 750mA, V_{IN} = V_{OUT} + 1V$ | | 4 | 20 | mA |
| | | $I_{OUT} = 1.5A, V_{IN} = V_{OUT} + 1V$ | | 17 | | mA |
| $I_{GND(do)}$ | Dropout Ground Pin Current | $V_{IN} \leq V_{OUT(nominal)} - 0.5V, I_{OUT} = 10mA$ | | 1.1 | | mA |
| $I_{OUT(lim)}$ | Current Limit | $V_{OUT} = 0V, V_{IN} = V_{OUT} + 1V$ | | 2.8 | | A |
| $I_{OUT(min)}$ | Minimum Load Current | | | 7 | 10 | mA |
| t_{START} | Start-up Time | $V_{EN} = V_{IN}, I_{OUT} = 10mA, C_{OUT} = 47\mu F$ | | 35 | 150 | μs |

Enable Input (MIC39151)

| | | | | | | |
|-----------------|-------------------------|------------------|------|----|----------|--------------------|
| V_{EN} | Enable Input Voltage | logic low (off) | | | 0.8 | V |
| | | logic high (on) | 2.25 | | | V |
| I_{IN} | Enable Input Current | $V_{EN} = 2.25V$ | 1 | 15 | 30 75 | μA μA |
| | | $V_{EN} = 0.8V$ | | | 2 4 | μA μA |
| $I_{OUT(shdn)}$ | Shutdown Output Voltage | Note 9 | | 10 | 20 | μA |

Flag Output (MIC39151)

| | | | | | | |
|-----------------|------------------------|--|----|------|------------|--------------------|
| $I_{FLG(leak)}$ | Output Leakage Current | $V_{OH} = 16V$ | | 0.01 | 1 2 | μA μA |
| $V_{FLG(do)}$ | Output Low Voltage | $V_{IN} = 2.250V, I_{OL} = 250\mu A, \text{Note 10}$ | | 180 | 300 400 | mV mV |
| V_{FLG} | Low Threshold | % of V_{OUT} | 93 | | | % |
| | High Threshold | % of V_{OUT} | | | 99.2 | % |
| | Hysteresis | | | 1 | | % |

| Symbol | Parameter | Condition | Min | Typ | Max | Units |
|---|---|----------------|--------------|-------|--------------|--------|
| Reference (Adjust Pin) – MIC39152 Only | | | | | | |
| V _{ADJ} | Reference Voltage | | 1.228 | 1.240 | 1.252 | V |
| | | | 1.215 | | 1.265 | V |
| V _{TC} | Reference Voltage Temperature Coefficient | Note 11 | | 20 | | ppm/°C |
| I _{ADJ} | Adjust Pin Bias Current | | | 40 | 80 | nA |
| | | | | | 120 | nA |

Notes:

- Exceeding the absolute maximum rating may damage the device.
- The device is not guaranteed to function outside its operating rating.
- Devices are ESD sensitive. Handling precautions recommended.
- $P_{D(max)} = (T_{J(max)} - T_A) \div \theta_{JA}$, where θ_{JA} depends upon the printed circuit layout. See "Applications Information."
- Specification for packaged product only.
- Output voltage temperature coefficient is $\Delta V_{OUT(worst\ case)} \div (T_{J(max)} - T_{J(min)})$ where $T_{J(max)}$ is +125°C and $T_{J(min)}$ is -40°C.
- $V_{DO} = V_{IN} - V_{OUT}$ when V_{OUT} decreases to 98% of its nominal output voltage with $V_{IN} = V_{OUT} + 1V$. For output voltages below 2.25V, dropout voltage is the input-to-output voltage differential with the minimum input voltage being 2.25V. Minimum input operating voltage is 2.25V.
- I_{GND} is the quiescent current. $I_{IN} = I_{GND} + I_{OUT}$.
- $V_{EN} \leq 0.8V$, $V_{IN} \leq 8V$, and $V_{OUT} = 0V$.
- For a 2.5V device, $V_{IN} = 2.250V$ (device is in dropout).
- Thermal regulation is defined as the change in output voltage at a time t after a change in power dissipation is applied, excluding load or line regulation effects. Specifications are for a 200mA load pulse at $V_{IN} = 8V$ for $t = 10ms$.

Typical Characteristics

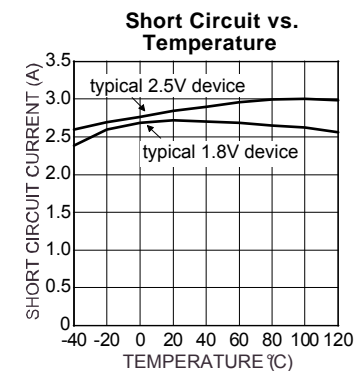
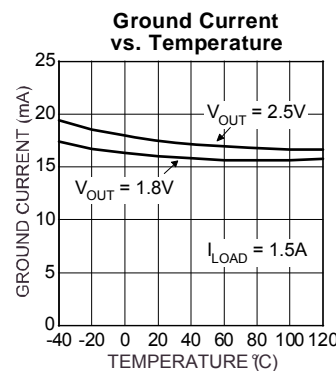
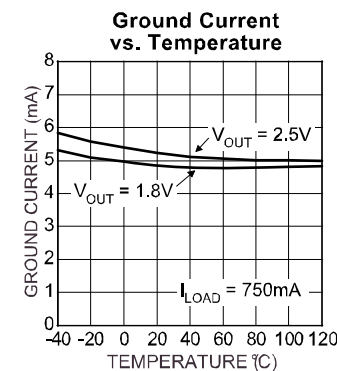
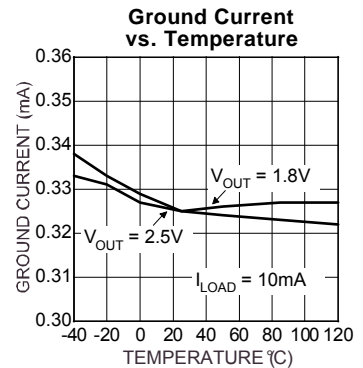
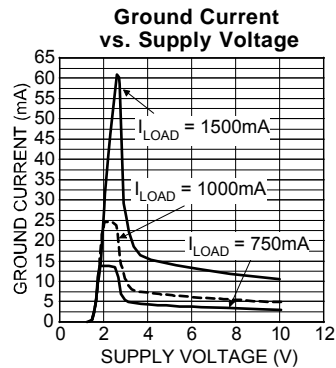
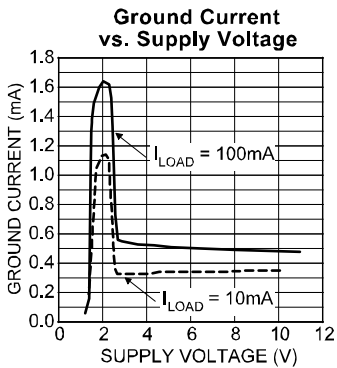
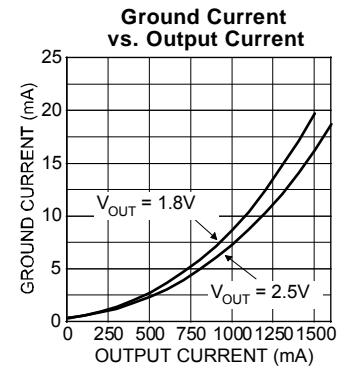
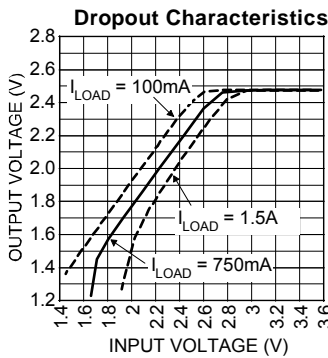
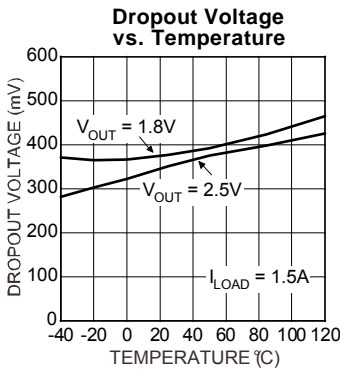
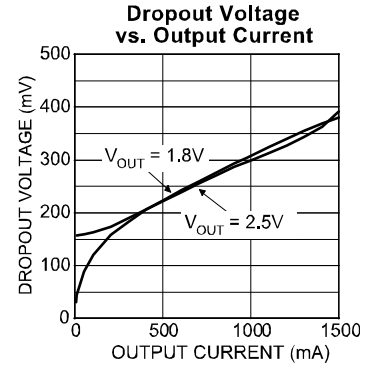
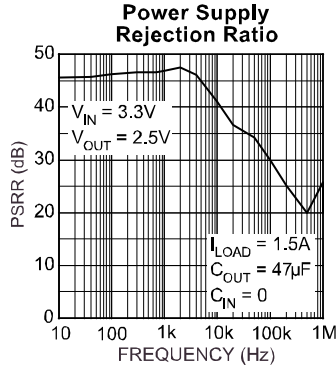
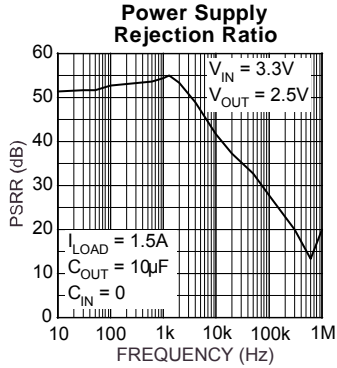

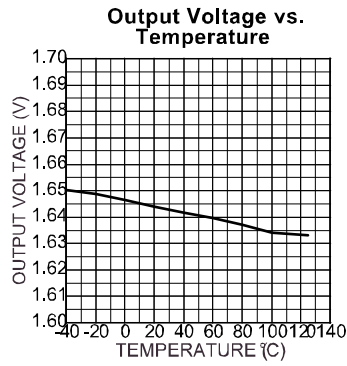
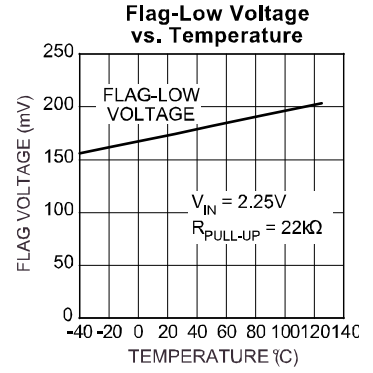
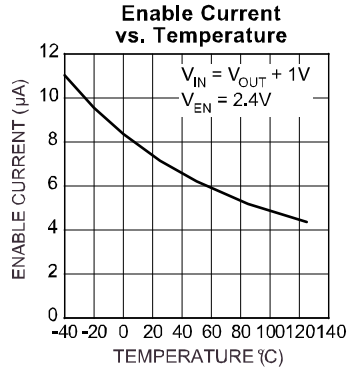
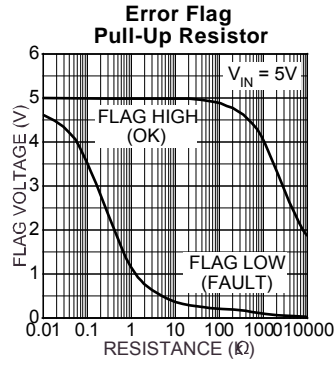

Functional Characteristics

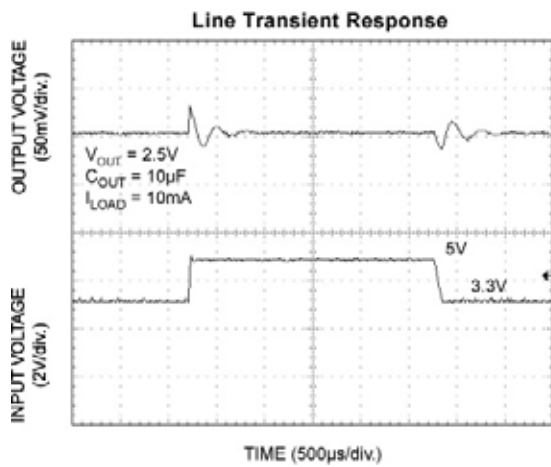
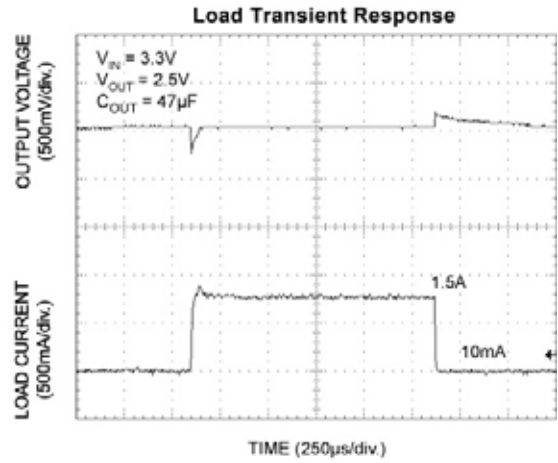
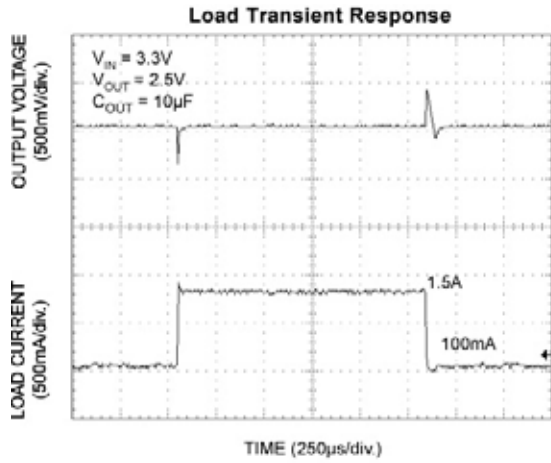

Functional Diagram

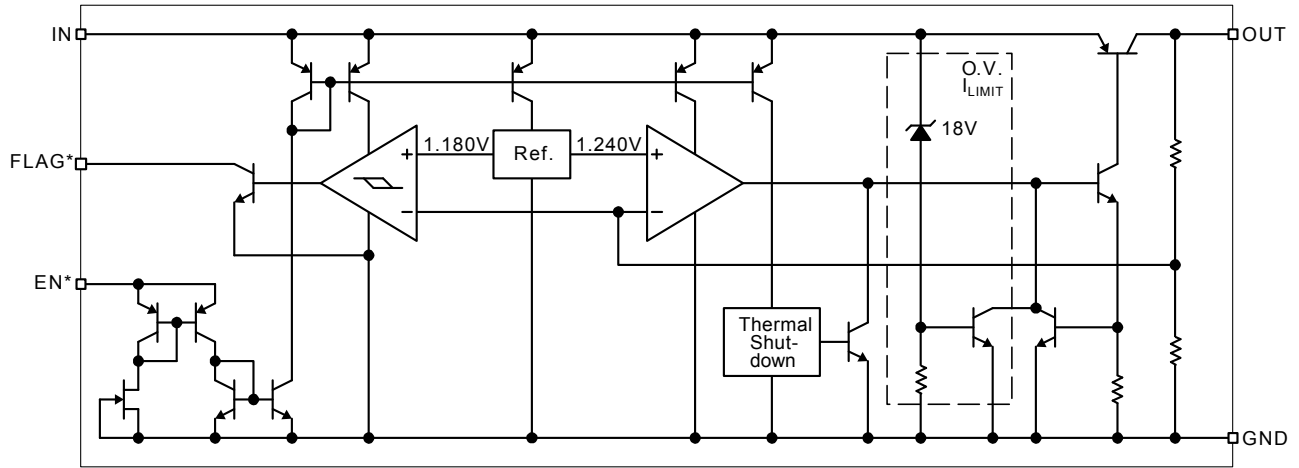

* MIC39151 only

Application Information

The MIC39150/1/2 are high-performance, low-dropout voltage regulators suitable for moderate to high-current voltage regulator applications. Its 500mV dropout voltage at full load and overtemperature makes it especially valuable in battery-powered systems and as high-efficiency noise filters in post-regulator applications. Unlike older NPN-pass transistor designs, where the minimum dropout voltage is limited by the base-to-emitter voltage drop and collector-to-emitter saturation voltage, dropout performance of the PNP output of these devices is limited only by the low V_{CE} saturation voltage.

A trade-off for the low dropout voltage is a varying base drive requirement. Micrel's Super β PNP[®] process reduces this drive requirement to only 2% to 5% of the load current. The MIC39150/1/2 regulators are fully protected from damage due to fault conditions. Current limiting is provided. This limiting is linear; output current during overload conditions is constant. Thermal shutdown disables the device when the die temperature exceeds the maximum safe operating temperature. Transient protection allows device (and load) survival even when the input voltage spikes above and below nominal. The output structure of these regulators allows voltages in excess of the desired output voltage to be applied without reverse current flow.

Thermal Design

Linear regulators are simple to use. The most complicated design parameters to consider are thermal characteristics. Thermal design requires the following application-specific parameters:

- Maximum ambient temperature (T_A)
- Output Current (I_{OUT})
- Output Voltage (V_{OUT})
- Input Voltage (V_{IN})
- Ground Current (I_{GND})

First, calculate the power dissipation of the regulator from these numbers and the device parameters from this datasheet.

$$P_D = (V_{IN} - V_{OUT}) I_{OUT} + V_{IN} I_{GND}$$

where the ground current is approximated by using numbers from the "Electrical Characteristics" or "Typical Characteristics." Then the heat sink thermal resistance is determined with this formula:

$$\theta_{SA} = \frac{T_{J(max)} - T_A}{P_D} - (\theta_{JC} + \theta_{CS})$$

Where $T_{J(max)} \leq 125^\circ\text{C}$ and θ_{CS} is between 0° and 2°C/W . The heat sink may be significantly reduced in applications where the minimum input voltage is known and is large compared with the dropout voltage. Use a series input resistor to drop excessive voltage and

distribute the heat between this resistor and the regulator. The low dropout properties of Micrel Super β PNP[®] regulators allow significant reductions in regulator power dissipation and the associated heat sink without compromising performance. When this technique is employed, a capacitor of at least $1\mu\text{F}$ is needed directly between the input and regulator ground.

Refer to *Application Note 9* for further details and examples on thermal design and heat sink specification.

With no heat sink in the application, calculate the junction temperature to determine the maximum power dissipation that will be allowed before exceeding the maximum junction temperature of the MIC39152. The maximum power allowed can be calculated using the thermal resistance (θ_{JA}) of the TO-252 (D-Pak) adhering to the following criteria for the PCB design: 2 oz. copper and 100mm^2 copper area for the MIC39152.

For example, given an expected maximum ambient temperature (T_A) of 75°C with $V_{IN} = 2.25\text{V}$, $V_{OUT} = 1.75\text{V}$, and $I_{OUT} = 1.5\text{A}$, first calculate the expected P_D using Equation (1);

$$P_D = (2.25\text{V} - 1.75\text{V})1.5\text{A} + (2.25\text{V})(0.017\text{A}) = 0.788\text{W}$$

Next, calculate the junction temperature for the expected power dissipation.

$$T_J = (\theta_{JA} \times P_D) + T_A = (56^\circ\text{C/W} \times 0.788\text{W}) + 75^\circ\text{C} \\ = 119.14^\circ\text{C}$$

Now determine the maximum power dissipation allowed that would not exceed the IC's maximum junction temperature (125°C) without the use of a heat sink by

$$P_{D(MAX)} = (T_{J(MAX)} - T_A) / \theta_{JA} = (125^\circ\text{C} - 75^\circ\text{C}) / (56^\circ\text{C/W}) \\ = 0.893\text{W}$$

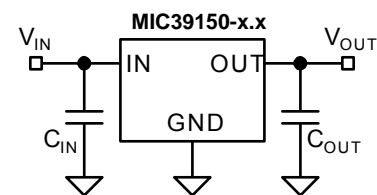

Figure 1. Capacitor Requirements

Output Capacitor

The MIC39150/1/2 requires an output capacitor to maintain stability and improve transient response. See Figure 1. Proper capacitor selection is important to ensure proper operation. The MIC39150/1/2 output capacitor selection is dependent upon the ESR (equivalent series resistance) of the output capacitor to maintain stability. When the output capacitor is $10\mu\text{F}$ or greater, the output capacitor should have an ESR less than 2Ω . This will improve transient response as well as

promote stability. Ultralow ESR capacitors (<100mΩ), such as ceramic chip capacitors may promote instability. These very low ESR levels may cause an oscillation and/or underdamped transient response. A low-ESR solid tantalum capacitor works extremely well and provides good transient response and stability over temperature. Aluminum electrolytics can also be used, as long as the ESR of the capacitor is < 2Ω.

The value of the output capacitor can be increased without limit. Higher capacitance values help to improve transient response and ripple rejection and reduce output noise.

Input Capacitor

An input capacitor of 1μF or greater is recommended when the device is more than 4 inches away from the bulk ac supply capacitance, or when the supply is a battery. Small, surface-mount, ceramic chip capacitors can be used for the bypassing. The capacitor should be placed within 1" of the device for optimal performance. Larger values will help to improve ripple rejection by bypassing the input to the regulator, further improving the integrity of the output voltage.

Transient Response and 3.3V to 2.5V or 2.5V to 1.8V Conversion

The MIC39150/1/2 has excellent transient response to variations in input voltage and load current. The device has been designed to respond quickly to load current variations and input voltage variations. Large output capacitors are not required to obtain this performance. A standard 10μF output capacitor, preferably tantalum, is all that is required. Larger values help to improve performance even further.

By virtue of its low-dropout voltage, this device does not saturate into dropout as readily as similar NPN-based designs. When converting from 3.3V to 2.5V, or 2.5V to 1.8V, the NPN-based regulators are already operating in dropout, with typical dropout requirements of 1.2V or greater. To convert down to 2.5V without operating in dropout, NPN-based regulators require an input voltage of 3.7V at the very least. The MIC39150/1 regulator will provide excellent performance with an input as low as 3.0V or 2.5V, respectively. This gives the PNP-based regulators a distinct advantage over older, NPN-based linear regulators.

Minimum Load Current

The MIC39150 regulator is specified between finite loads. If the output current is too small, leakage currents dominate and the output voltage rises. A 10mA minimum load current is necessary for proper regulation.

Error Flag

The MIC39151 version features an error flag circuit which monitors the output voltage and signals an error condition when the voltage 5% below the nominal output voltage. The error flag is an open-collector output that can sink 10mA during a fault condition.

Low output voltage can be caused by a number of problems, including an overcurrent fault (device in current limit) or low input voltage. The flag is inoperative during overtemperature shutdown.

When the error flag is not used, it is best to leave it open. A pull-up resistor from FLG to either V_{IN} or V_{OUT} is required for proper operation.

Enable Input

The MIC39151/2 features an enable input for on/off control of the device. The enable input's shutdown state draws "zero" current (only microamperes of leakage). The enable input is TTL/CMOS compatible for simple logic interface, but can be connected to up to 20V. When enabled, it draws approximately 15μA.

Adjustable Regulator Design

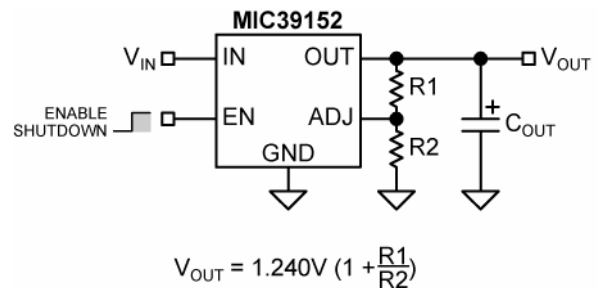

Figure 2. Adjustable Regulator with Resistors

The MIC39152 allows programming the output voltage anywhere between 1.24V and 15.5V. Two resistors are used. The resistor values are calculated by:

$$R1 = R2 \times \left(\frac{V_{OUT}}{1.240} - 1\right)$$

Where V_{OUT} is the desired output voltage. Figure 2 shows component definition. Applications with widely varying load currents may scale the resistors to draw the minimum load current required for proper operation (see *Minimum Load Current* section).

Package Information

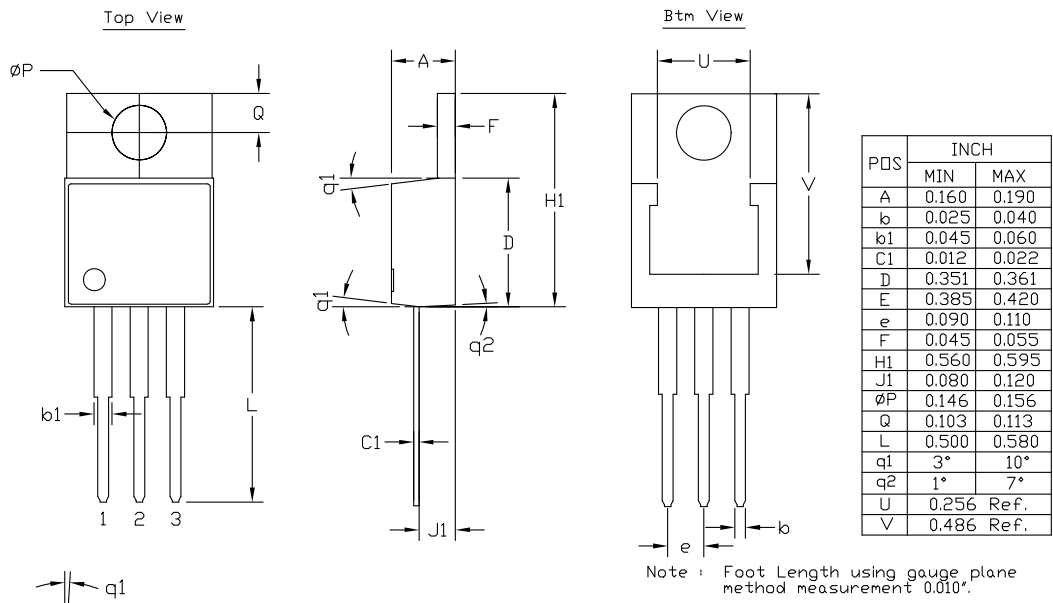

3-Pin TO-220 (T)

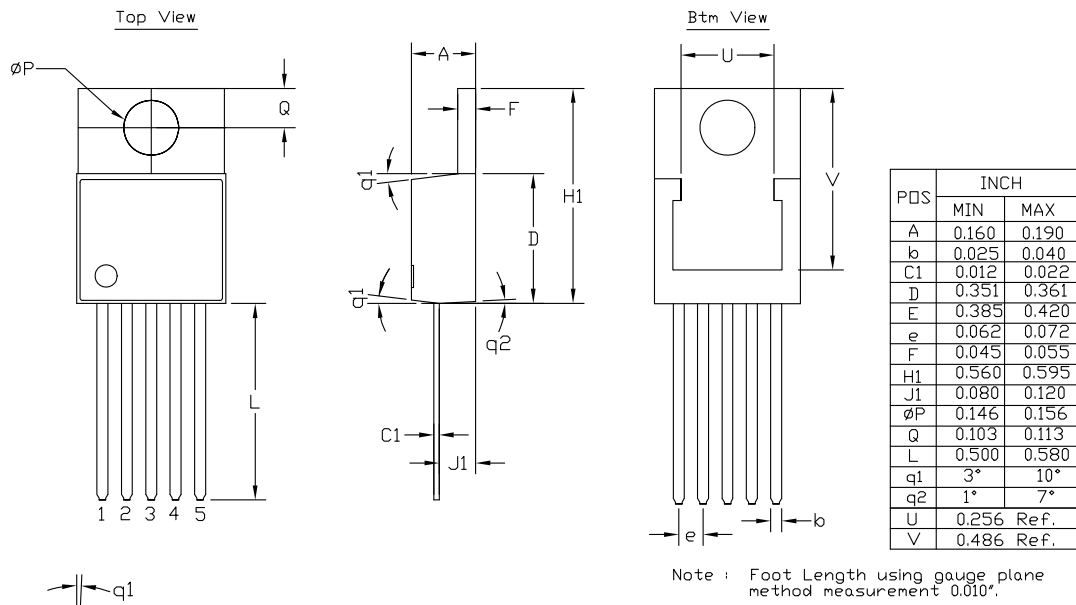

5-Pin TO-220 (T)

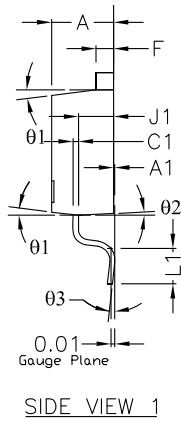
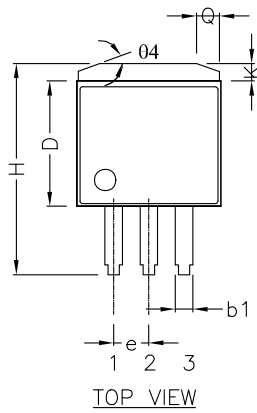

| POS | INCH | | MM | |
|-----|-------|-------|--------|--------|
| | MIN | MAX | MIN | MAX |
| A | 0.171 | 0.181 | 4.343 | 4.597 |
| A1 | 0.000 | 0.012 | 0.000 | 0.305 |
| b1 | 0.047 | 0.053 | 1.194 | 1.346 |
| C1 | 0.012 | 0.018 | 0.305 | 0.457 |
| D | 0.351 | 0.361 | 8.915 | 9.169 |
| E | 0.400 | 0.420 | 10.160 | 10.668 |
| e | 0.095 | 0.105 | 2.413 | 2.667 |
| F | 0.045 | 0.055 | 1.143 | 1.397 |
| H | 0.575 | 0.625 | 14.605 | 15.875 |
| J1 | 0.080 | 0.120 | 2.032 | 3.048 |
| L1 | 0.090 | 0.110 | 2.286 | 2.794 |
| K | 0.045 | 0.055 | 1.143 | 1.397 |
| 01 | 3° | 10° | 3° | 10° |
| 02 | 1° | 7° | 1° | 7° |
| 03 | 0° | 8° | 0° | 8° |
| 04 | 18° | 22° | 18° | 22° |
| Q | 0.055 | 0.075 | 1.397 | 1.905 |
| U | 0.256 | Ref. | 6.502 | Ref. |
| V | 0.303 | Ref. | 7.696 | Ref. |

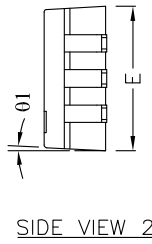
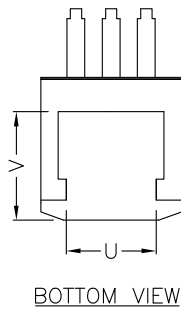

NOTE:
FOOT LENGTH USING GAUGE PLANE
METHOD MEASUREMENT 0.010".

3-Pin TO-263 (U)

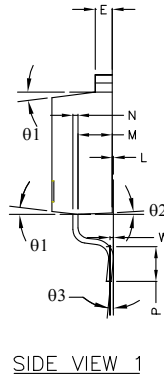
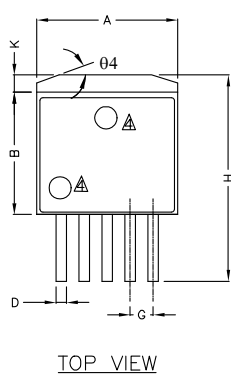

| POS | INCH | | MM | |
|-----|-------|-------|--------|--------|
| | MIN | MAX | MIN | MAX |
| A | 0.396 | 0.420 | 10.058 | 10.668 |
| B | 0.330 | 0.361 | 8.382 | 9.169 |
| C | 0.170 | 0.181 | 4.318 | 4.597 |
| D | 0.026 | 0.036 | 0.660 | 0.914 |
| E | 0.045 | 0.055 | 1.143 | 1.397 |
| G | 0.067 | Ref. | 1.70 | Ref. |
| H | 0.575 | 0.625 | 14.605 | 15.875 |
| K | 0.045 | 0.066 | 1.143 | 1.676 |
| L | 0 | 0.012 | 0 | 0.305 |
| M | 0.080 | 0.120 | 2.032 | 3.048 |
| N | 0.012 | 0.023 | 0.305 | 0.584 |
| P | 0.090 | 0.110 | 2.286 | 2.794 |
| 01 | 3° | 10° | 3° | 10° |
| 02 | 1° | 7° | 1° | 7° |
| 03 | 0° | 8° | 0° | 8° |
| 04 | 18° | 22° | 18° | 22° |
| U | 0.300 | Ref. | 7.620 | Ref. |
| V | 0.305 | Ref. | 7.747 | Ref. |
| W | 0.010 | Ref. | 0.254 | Ref. |

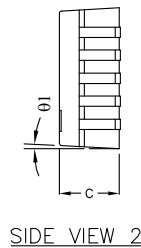
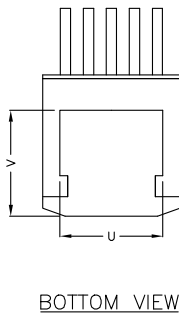

NOTE:
1. PACKAGE OUTLINE EXCLUSIVE OF MOLD FLASH & METAL BURR.
2. PACKAGE OUTLINE INCLUSIVE OF PLATING THICKNESS.
3. FOOT LENGTH MEASURED AT INTERCEPT POINT BETWEEN DATUM A & LEAD SURFACE
▲ PACKAGE TOP MARK MAY BE IN TOP CENTER OR LOWER LEFT CORNER

5-Pin TO-263 (U)

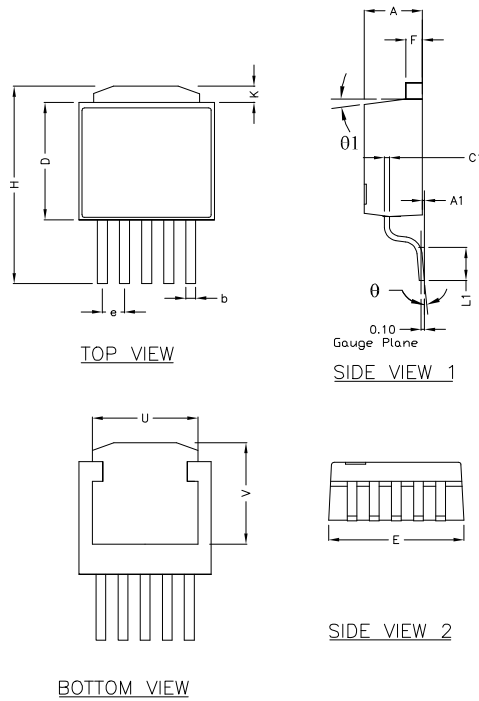

| PDS | INCH | | MM | |
|-----|-------|-------|-------|--------|
| | MIN | MAX | MIN | MAX |
| A | 0.087 | 0.094 | 2.210 | 2.387 |
| A1 | 0.000 | 0.012 | 0.000 | 0.305 |
| b | 0.023 | 0.026 | 0.584 | 0.660 |
| C1 | 0.012 | 0.023 | 0.305 | 0.584 |
| D | 0.236 | 0.241 | 6.000 | 6.200 |
| E | 0.252 | 0.260 | 6.400 | 6.604 |
| e | 0.045 | 0.055 | 1.143 | 1.397 |
| F | 0.019 | 0.023 | 0.483 | 0.584 |
| H | 0.378 | 0.402 | 9.601 | 10.210 |
| K | 0.039 | 0.047 | 1.000 | 1.200 |
| L1 | 0.055 | 0.065 | 1.397 | 1.651 |
| θ | 0° | 8° | 0° | 8° |
| θ1 | 3° | 10° | 3° | 10° |
| Q | 0.055 | 0.075 | 1.397 | 1.905 |
| U | 0.206 | Ref. | 5.232 | Ref. |
| V | 0.213 | Ref. | 5.415 | Ref. |

NOTE:
 1. PACKAGE OUTLINE EXCLUSIVE OF MOLD FLASH & METAL BURR.
 2. PACKAGE OUTLINE INCLUSIVE OF PLATING THICKNESS.
 3. FOOT LENGTH USING GAUGE PLANE METHOD MEASUREMENT 0.010"
 4. ALL DIMENSIONS ARE IN INCHES/MILLIMETERS.

5-Pin TO-252 (D)

MICREL, INC. 2180 FORTUNE DRIVE SAN JOSE, CA 95131 USA
 TEL +1 (408) 944-0800 FAX +1 (408) 474-1000 WEB <http://www.micrel.com>

The information furnished by Micrel in this data sheet is believed to be accurate and reliable. However, no responsibility is assumed by Micrel for its use. Micrel reserves the right to change circuitry and specifications at any time without notification to the customer.

Micrel Products are not designed or authorized for use as components in life support appliances, devices or systems where malfunction of a product can reasonably be expected to result in personal injury. Life support devices or systems are devices or systems that (a) are intended for surgical implant into the body or (b) support or sustain life, and whose failure to perform can be reasonably expected to result in a significant injury to the user. A Purchaser's use or sale of Micrel Products for use in life support appliances, devices or systems is a Purchaser's own risk and Purchaser agrees to fully indemnify Micrel for any damages resulting from such use or sale.

© 2009 Micrel, Incorporated.

Looking for pricing, stock, or lifecycle information?

Click below to explore more details on WIN SOURCE:

- ⊖ [View MIC39151-1.65BU on WIN SOURCE](#)
- ⊖ [Microchip Technology](#) Information

Optimize Your Supply Chain with WIN SOURCE Solutions

- ✓ Global Sourcing Solution
- ✓ Obsolete Management
- ✓ Cost Control Management
- ✓ Shortage Management
- ✓ Alternative Solution
- ✓ Excess Inventory Management