



**THE DATASHEET OF
ZXMD63P02XTC**



DUAL 20V P-CHANNEL ENHANCEMENT MODE MOSFET

Product Summary

$V_{(BR)DSS}$	$R_{DS(ON)}$	I_D
-20V	0.27Ω	-1.7A

Description

This new generation of high density MOSFETs from Diodes Incorporated utilises a unique structure that combines the benefits of low on-resistance with fast switching speed. This makes them ideal for high efficiency, low voltage, power management applications.

Features

- Low On-resistance
- Fast Switching Speed
- Low Threshold
- Low Gate Drive
- Low Profile SOIC Package

Applications

- DC - DC Converters
- Power Management Functions
- Disconnect Switches
- Motor Control



MSOP8

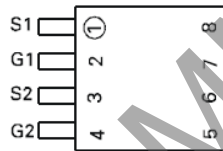

Top View

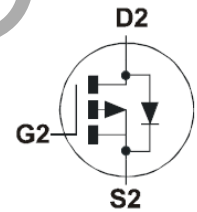
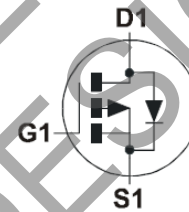

Ordering Information

Part Number	Device Marking	Reel Size (inches)	Tape Width (mm)	Quantity Per Reel
ZXMD63P02XTA	ZXM63P02	7	12mm Embossed	1000 Units
ZXMD63P02XTC	ZXM63P02	13	12mm Embossed	4000 Units

Absolute Maximum Ratings

PARAMETER	SYMBOL	LIMIT	UNIT
Drain-Source Voltage	V_{DSS}	-20	V
Gate- Source Voltage	V_{GS}	± 12	V
Continuous Drain Current (V _{GS} =-4.5V, T _A =25°C) (b) (d) (V _{GS} =-4.5V, T _A =70°C) (b) (d)	I_D	-1.7 -1.35	A
Pulsed Drain Current (c)(d)	I_{DM}	-9.6	A
Continuous Source Current (Body Diode)(b)(d)	I_S	-1.4	A
Pulsed Source Current (Body Diode)(c)(d)	I_{SM}	-9.6	A
Power Dissipation at T _A =25°C (a)(d) Linear Derating Factor	P_D	0.87 6.9	W mW/°C
Power Dissipation at T _A =25°C (a)(e) Linear Derating Factor	P_D	1.04 8.3	W mW/°C
Power Dissipation at T _A =25°C (b)(d) Linear Derating Factor	P_D	1.25 10	W mW/°C
Operating and Storage Temperature Range	T _j ;T _{stg}	-55 to +150	°C

Thermal Resistance

PARAMETER	SYMBOL	VALUE	UNIT
Junction to Ambient (a)(d)	$R_{\theta JA}$	143	°C/W
Junction to Ambient (b)(d)	$R_{\theta JA}$	100	°C/W
Junction to Ambient (a)(e)	$R_{\theta JA}$	120	°C/W

NOTES

- (a) For a device surface mounted on 25mm x 25mm FR4 PCB with high coverage of single sided 1oz copper, in still air conditions
- (b) For a device surface mounted on FR4 PCB measured at $t \leq 10$ secs.
- (c) Repetitive rating - pulse width limited by maximum junction temperature. Refer to Transient Thermal Impedance graph.
- (d) For device with one active die.
- (e) For device with two active die running at equal power.

Characteristics

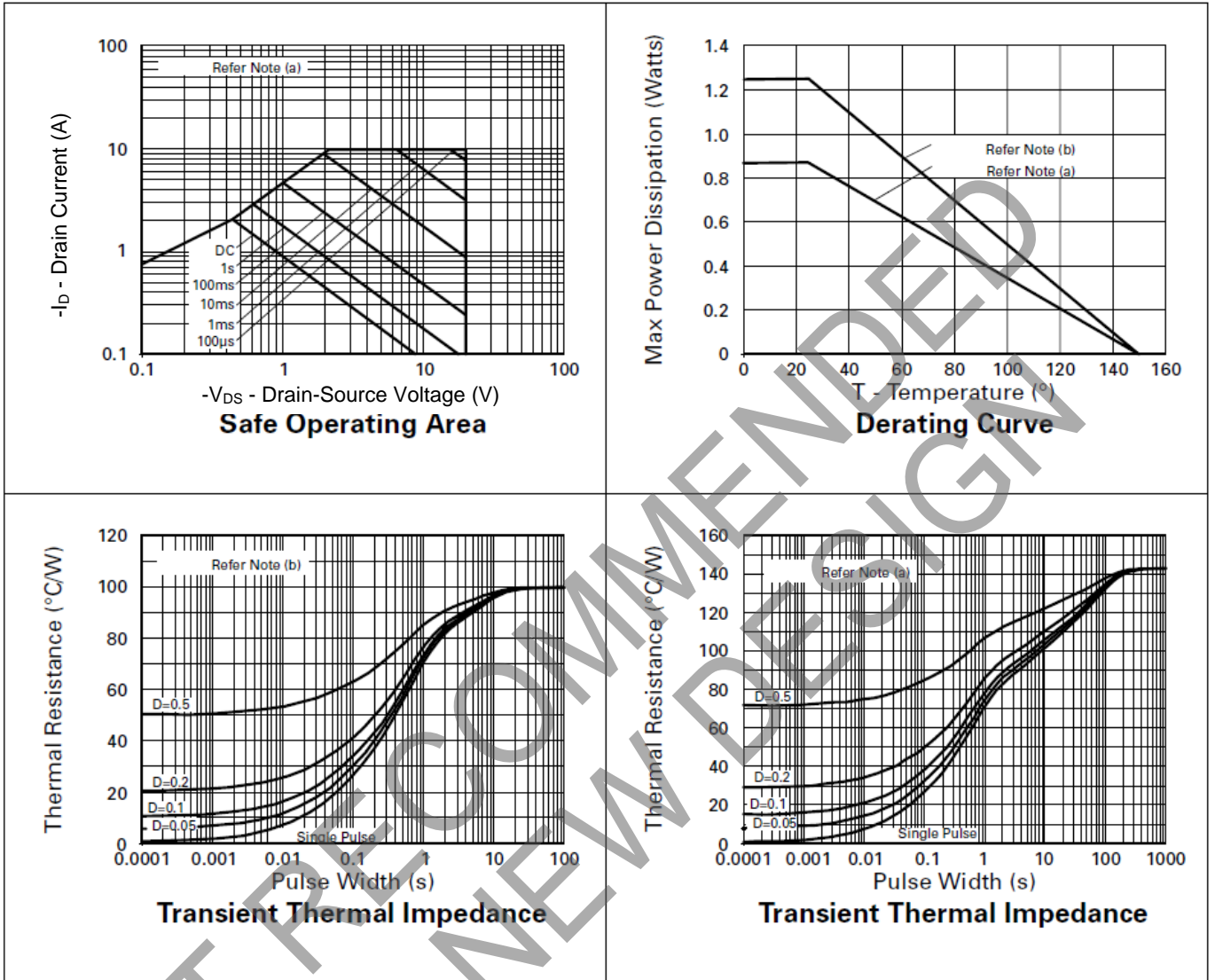

NOT FOR NEW DESIGN

Electrical Characteristics (@T_A = +25°C, unless otherwise specified.)

PARAMETER	SYMBOL	MIN.	TYP.	MAX.	UNIT	CONDITIONS.
STATIC						
Drain-Source Breakdown Voltage	V _{(BR)DSS}	-20			V	I _D =-250μA, V _{GS} =0V
Zero Gate Voltage Drain Current	I _{DSS}			-1	μA	V _{DS} =-20V, V _{GS} =0V
Gate-Body Leakage	I _{GSS}			±100	nA	V _{GS} =±12V, V _{DS} =0V
Gate-Source Threshold Voltage	V _{GS(th)}	-0.7			V	I _D =-250μA, V _{DS} =V _{GS}
Static Drain-Source On-State Resistance (1)	R _{DS(on)}			0.27 0.40	Ω	V _{GS} =-4.5V, I _D =-1.2A V _{GS} =-2.7V, I _D =-0.6A
Forward Transconductance (3)	g _{fs}	1.3			S	V _{DS} =-10V, I _D =-0.6A
DYNAMIC (3)						
Input Capacitance	C _{iss}		290		pF	V _{DS} =-15V, V _{GS} =0V, f=1MHz
Output Capacitance	C _{oss}		120		pF	
Reverse Transfer Capacitance	C _{rss}		50		pF	
SWITCHING(2) (3)						
Turn-On Delay Time	t _{d(on)}		3.4		ns	V _{DD} =-10V, I _D =-1.2A R _G =6.0Ω, R _D =8.3Ω (Refer to test circuit)
Rise Time	t _r		9.6		ns	
Turn-Off Delay Time	t _{d(off)}		16.4		ns	
Fall Time	t _f		20.4		ns	
Total Gate Charge	Q _g			5.25	nC	
Gate-Source Charge	Q _{gs}			1.0	nC	V _{DS} =-16V, V _{GS} =-4.5V, I _D =-1.2A (Refer to test circuit)
Gate Drain Charge	Q _{gd}			2.25	nC	
SOURCE-DRAIN DIODE						
Diode Forward Voltage (1)	V _{SD}			-0.95	V	T _j =25°C, I _S =-1.2A, V _{GS} =0V
Reverse Recovery Time (3)	t _{rr}		21.7		ns	T _j =25°C, I _F =-1.2A, di/dt= 100A/μs
Reverse Recovery Charge(3)	Q _{rr}		9.6		nC	

(1) Measured under pulsed conditions. Width=300μs. Duty cycle ≤2% .

(2) Switching characteristics are independent of operating junction temperature.

(3) For design aid only, not subject to production testing.

Typical Characteristics

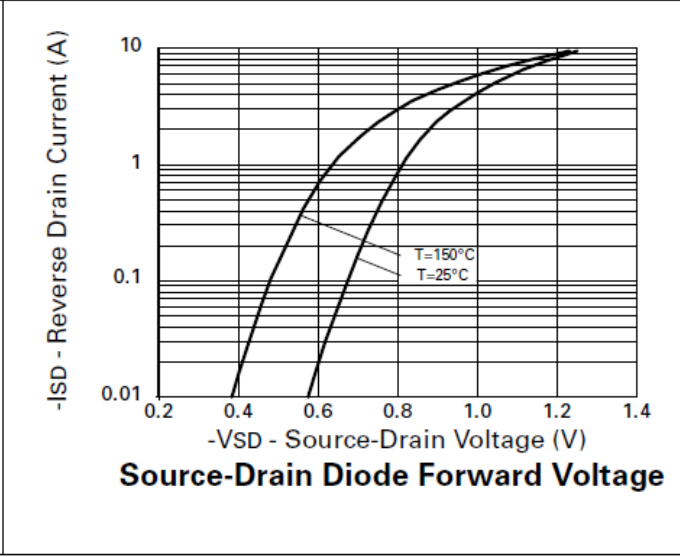
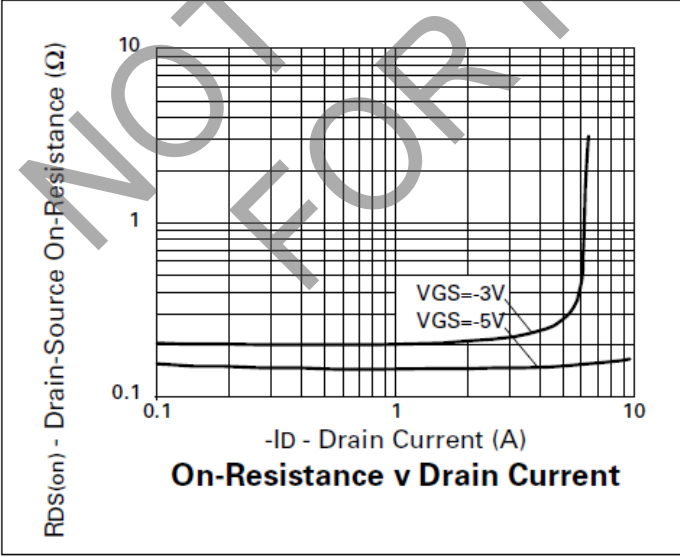
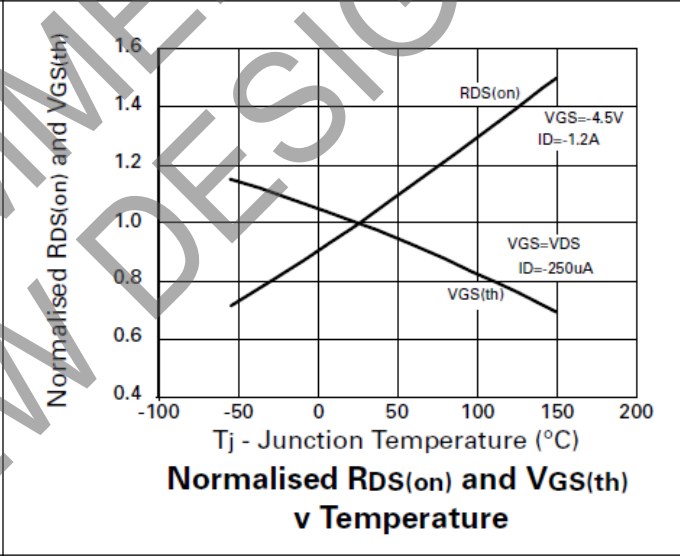
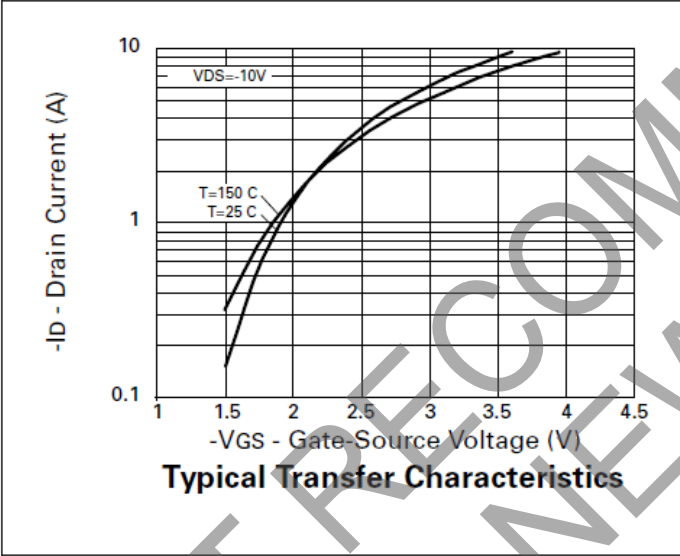
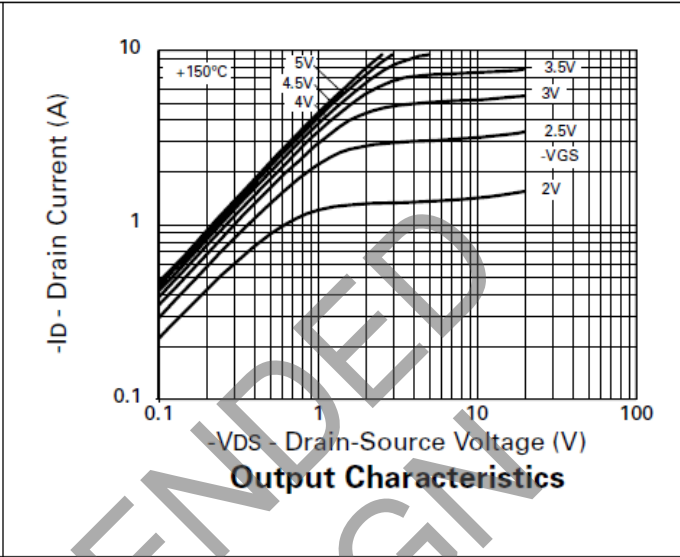
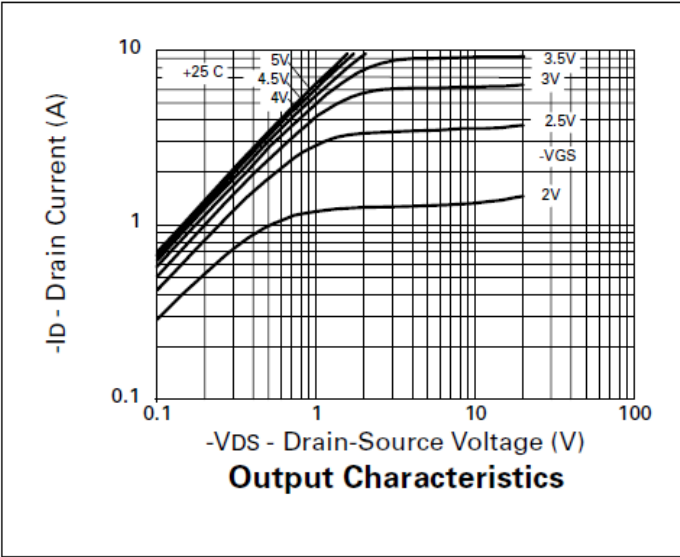

Typical Characteristics (Cont.)

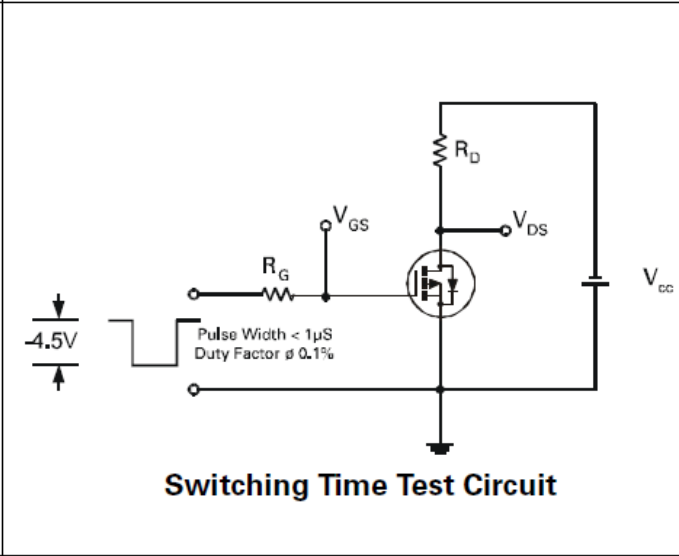
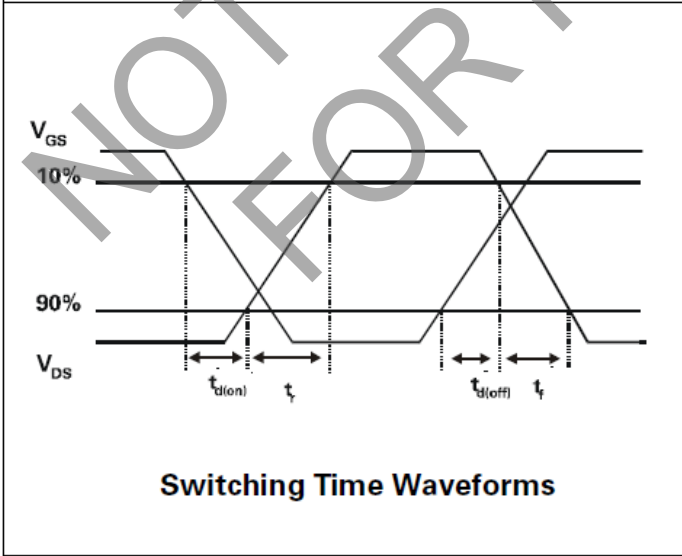
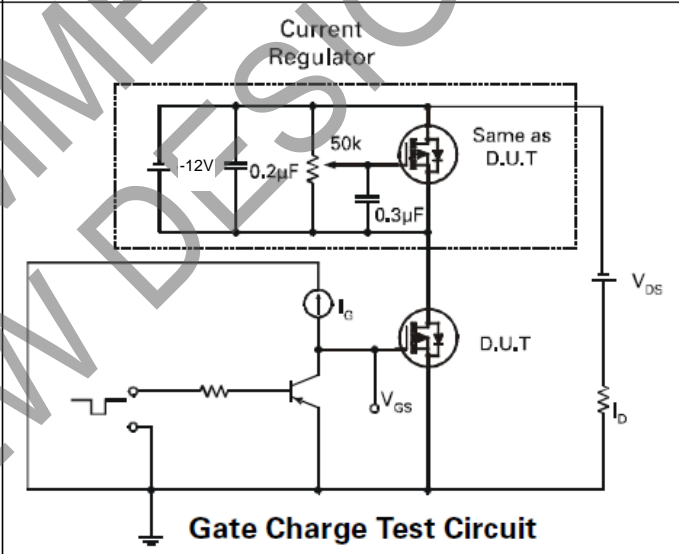
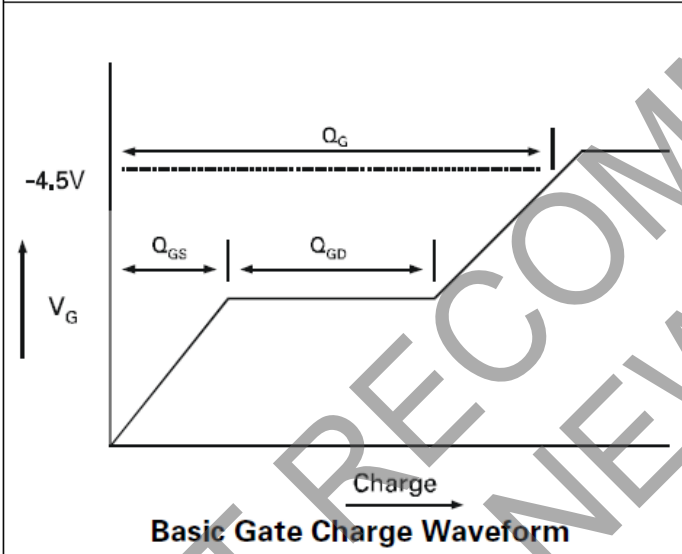
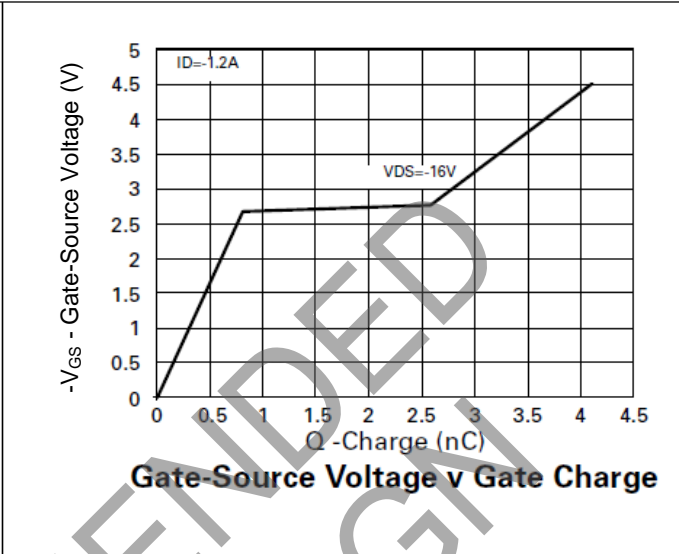
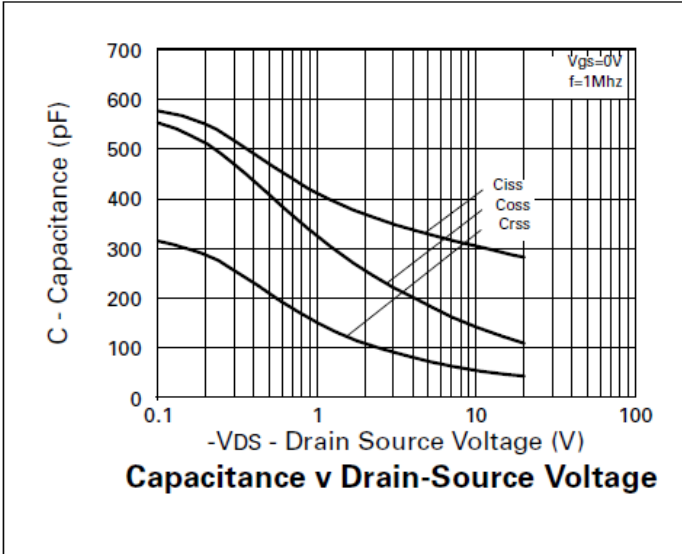

Package Outline Dimensions

Please see <http://www.diodes.com/package-outlines.html> for the latest version.

MSOP8

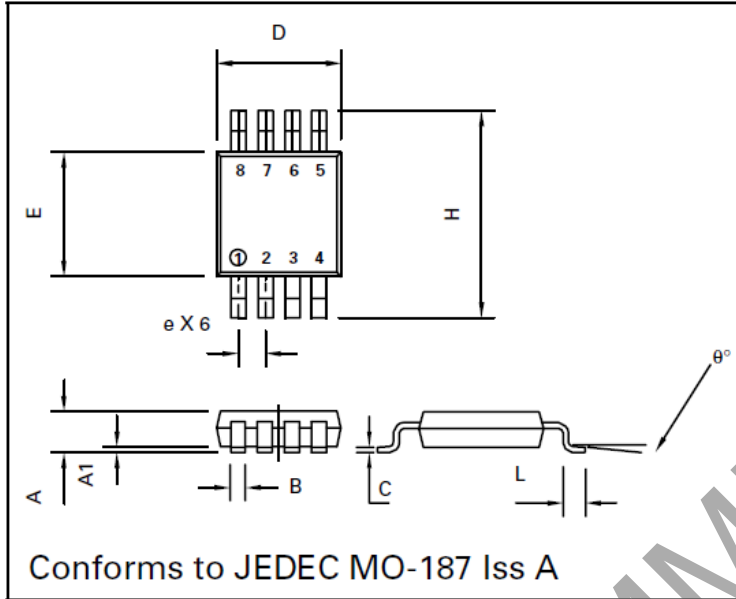

DIM	Millimetres		Inches	
	MIN	MAX	MIN	MAX
A		1.10	0.043	
A1	0.05	0.15	0.002	0.006
B	0.25	0.40	0.010	0.016
C	0.13	0.23	0.005	0.009
D	2.90	3.10	0.114	0.122
e	0.65	BSC	0.0256	BSC
E	2.90	3.10	0.114	0.122
H	4.90	BSC	0.193	BSC
L	0.40	0.70	0.016	0.028
q°	0°	6°	0°	6°

Suggested Pad Layout

Please see <http://www.diodes.com/package-outlines.html> for the latest version.

MSOP8

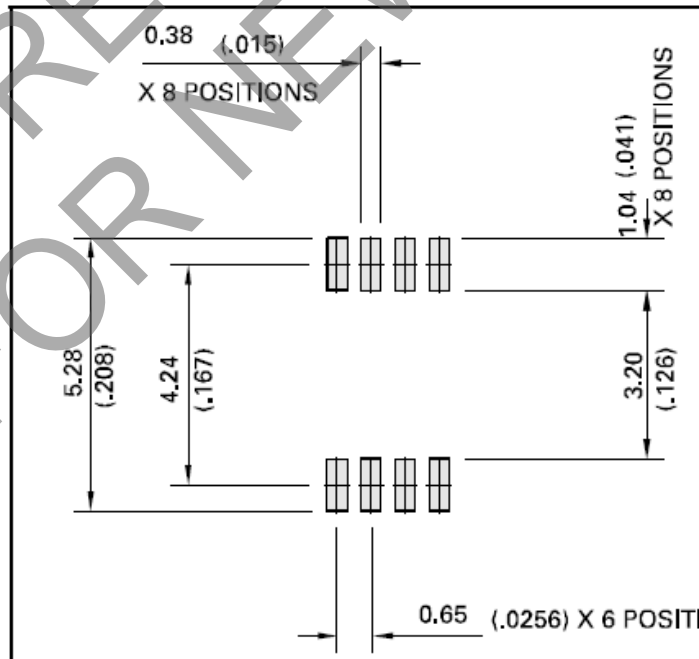

IMPORTANT NOTICE

DIODES INCORPORATED MAKES NO WARRANTY OF ANY KIND, EXPRESS OR IMPLIED, WITH REGARDS TO THIS DOCUMENT, INCLUDING, BUT NOT LIMITED TO, THE IMPLIED WARRANTIES OF MERCHANTABILITY AND FITNESS FOR A PARTICULAR PURPOSE (AND THEIR EQUIVALENTS UNDER THE LAWS OF ANY JURISDICTION).

Diodes Incorporated and its subsidiaries reserve the right to make modifications, enhancements, improvements, corrections or other changes without further notice to this document and any product described herein. Diodes Incorporated does not assume any liability arising out of the application or use of this document or any product described herein; neither does Diodes Incorporated convey any license under its patent or trademark rights, nor the rights of others. Any Customer or user of this document or products described herein in such applications shall assume all risks of such use and will agree to hold Diodes Incorporated and all the companies whose products are represented on Diodes Incorporated website, harmless against all damages.

Diodes Incorporated does not warrant or accept any liability whatsoever in respect of any products purchased through unauthorized sales channel. Should Customers purchase or use Diodes Incorporated products for any unintended or unauthorized application, Customers shall indemnify and hold Diodes Incorporated and its representatives harmless against all claims, damages, expenses, and attorney fees arising out of, directly or indirectly, any claim of personal injury or death associated with such unintended or unauthorized application.

Products described herein may be covered by one or more United States, international or foreign patents pending. Product names and markings noted herein may also be covered by one or more United States, international or foreign trademarks.

This document is written in English but may be translated into multiple languages for reference. Only the English version of this document is the final and determinative format released by Diodes Incorporated.

LIFE SUPPORT

Diodes Incorporated products are specifically not authorized for use as critical components in life support devices or systems without the express written approval of the Chief Executive Officer of Diodes Incorporated. As used herein:

A. Life support devices or systems are devices or systems which:

1. are intended to implant into the body, or
2. support or sustain life and whose failure to perform when properly used in accordance with instructions for use provided in the labeling can be reasonably expected to result in significant injury to the user.

B. A critical component is any component in a life support device or system whose failure to perform can be reasonably expected to cause the failure of the life support device or to affect its safety or effectiveness.



Customers represent that they have all necessary expertise in the safety and regulatory ramifications of their life support devices or systems, and acknowledge and agree that they are solely responsible for all legal, regulatory and safety-related requirements concerning their products and any use of Diodes Incorporated products in such safety-critical, life support devices or systems, notwithstanding any devices- or systems-related information or support that may be provided by Diodes Incorporated. Further, Customers must fully indemnify Diodes Incorporated and its representatives against any damages arising out of the use of Diodes Incorporated products in such safety-critical, life support devices or systems.

Copyright © 2018, Diodes Incorporated

www.diodes.com

Looking for pricing, stock, or lifecycle information?

Click below to explore more details on WIN SOURCE:

-  [View ZXMD63P02XTC on WIN SOURCE](#)
-  [Diodes Incorporated Information](#)

Optimize Your Supply Chain with WIN SOURCE Solutions

-  Global Sourcing Solution
-  Obsolete Management
-  Cost Control Management
-  Shortage Management
-  Alternative Solution
-  Excess Inventory Management