



# THE DATASHEET OF UC3901D



# Isolated Feedback Generator

## FEATURES

- An Amplitude-Modulation System for Transformer Coupling an Isolated Feedback Error Signal
- Low-Cost Alternative to Optical Couplers
- Internal 1% Reference and Error Amplifier
- Internal Carrier Oscillator Usable to 5MHz
- Modulator Synchronizable to an External Clock
- Loop Status Monitor

## DESCRIPTION

The UC1901 family is designed to solve many of the problems associated with closing a feedback control loop across a voltage isolation boundary. As a stable and reliable alternative to an optical coupler, these devices feature an amplitude modulation system which allows a loop error signal to be coupled with a small RF transformer or capacitor.

The programmable, high-frequency oscillator within the UC1901 series permits the use of smaller, less expensive transformers which can readily be built to meet the isolation requirements of today's line-operated power systems. As an alternative to RF operation, the external clock input to these devices allows synchronization to a system clock or to the switching frequency of a SMPS.

An additional feature is a status monitoring circuit which provides an active-low output when the sensed error voltage is within  $\pm 10\%$  of the reference. The DRIVERB output, DRIVERA output, and STATUS output are disabled until the input supply has reached a sufficient level to allow proper operation of the device.

Since these devices can also be used as a DC driver for optical couplers, the benefits of 4.5 to 40V supply operation, a 1% accurate reference, and a high gain general purpose amplifier offer advantages even though an AC system may not be desired.

## UC1901 SIMPLIFIED SCHEMATIC

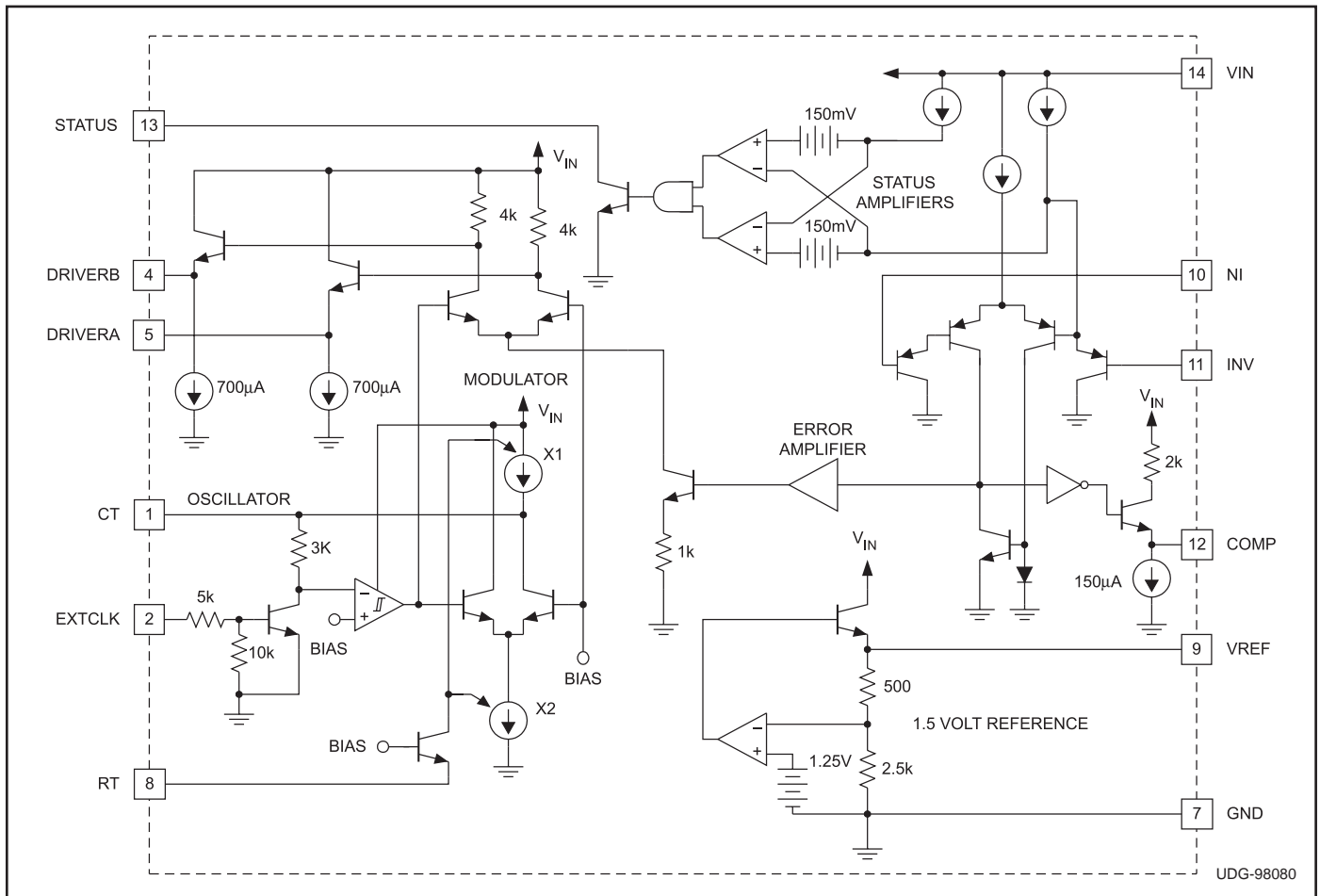

### ABSOLUTE MAXIMUM RATINGS (Note 1)

Input Supply Voltage, $V_{IN}$ .....	40V
Reference Output Current .....	-10mA
Driver Output Currents .....	-35mA
Status Indicator Voltage .....	40V
Status Indicator Current .....	20mA
Ext. Clock Input .....	40V
Error Amplifier Inputs .....	-0.5V to +35V
Power Dissipation at $T_A = 25^\circ\text{C}$ .....	1000mW
Power Dissipation at $T_c = 25^\circ\text{C}$ .....	2000mW
Operating Junction Temperature .....	-55°C to +150°C
Storage Temperature .....	-65°C to +150°C
Lead Temperature (Soldering, 10 seconds) .....	300°C

**Note 1:** Voltages are referenced to ground, Pin 7. Currents are positive into, negative out of the specified terminal.

**Note 2:** Consult Packaging section of Databook for thermal limitations and considerations of package.

### CONNECTION DIAGRAMS

#### DIL-14, SOIC-14 (TOP VIEW) J or N Package, D Package

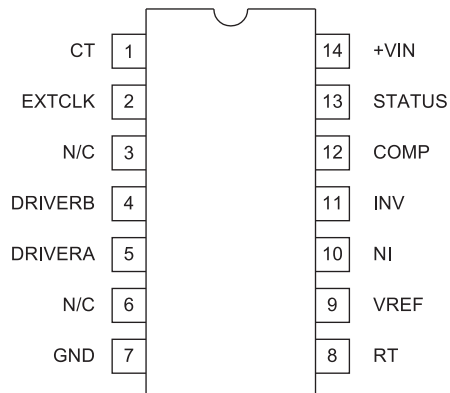

#### SOIC-16 Wide (TOP VIEW) DW Package

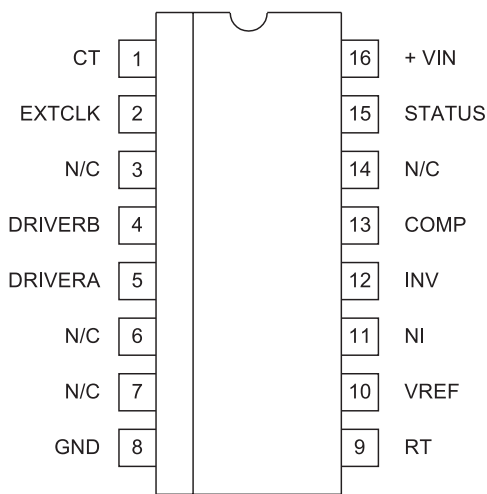

#### PLCC-20, LCC-20 (TOP VIEW) Q, L Packages

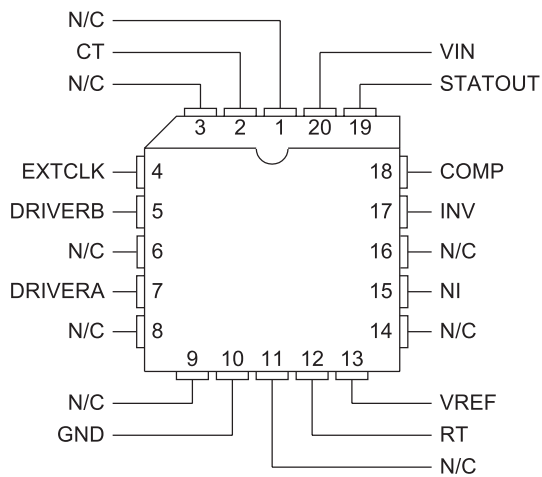

### TEMPERATURE AND PACKAGE SELECTION GUIDE

	TEMPERATURE RANGE	AVAILABLE PACKAGES
UC1901	-55°C to +125°C	J, L
UC2901	-40°C to +85°C	D, DW, J, N, Q
UC3901	0°C to +70°C	D, DW, J, N, Q

**ELECTRICAL CHARACTERISTICS** Unless otherwise stated, these specifications apply for  $V_{IN} = 10V$ ,  $R_T = 10k\Omega$ ,  $C_T = 820pF$ ,  $T_A = T_J$ .

PARAMETER	TEST CONDITIONS	UC1901/UC2901			UC3901			UNITS
		MIN	TYP	MAX	MIN	TYP	MAX	
<b>Reference Section</b>								
Output Voltage	$T_J = 25^\circ C$	1.485	1.5	1.515	1.47	1.5	1.53	V
	$T_{MIN} \leq T_J \leq T_{MAX}$	1.470	1.5	1.530	1.455	1.5	1.545	
Line Regulation	$V_{IN} = 4.5$ to $35V$		2	10		2	15	mV
Load Regulation	$I_{OUT} = 0$ to $5mA$		4	10		4	15	mV
Short Circuit Current	$T_J = 25^\circ C$		-35	-55		-35	-55	mV
<b>Error Amplifier Section (To Compensation Terminal)</b>								
Input Offset Voltage	$V_{CM} = 1.5V$		1	4		1	8	mV
Input Bias Current	$V_{CM} = 1.5V$		-1	-3		-1	-6	$\mu A$
Input Offset Current	$V_{CM} = 1.5V$		0.1	1		0.1	2	$\mu A$
Small Signal Open Loop Gain		40	60		40	60		dB
CMRR	$V_{CM} = 0.5$ to $7.5V$	60	80		60	80		dB
PSRR	$V_{IN} = 5$ to $25V$	80	100		80	100		dB
Output Swing, $\Delta V_o$		0.4	0.7		0.4	0.7		V
Maximum Sink Current		90	150		90	150		$\mu A$
Maximum Source Current		-2	-3		-2	-3		mA
Gain Band Width Product			1			1		MHz
Slew Rate			0.3			0.3		V/ $\mu S$
<b>Modulators/Drivers Section (From Compensation Terminal)</b>								
Voltage Gain		11	12	13	10	12	14	dB
Output Swing		$\pm 1.6$	$\pm 2.8$		$\pm 1.6$	$\pm 2.8$		V
Driver Sink Current		500	700		500	700		$\mu A$
Driver Source Current		-15	-35		-15	-35		mA
Gain Band Width Product			25			25		MHz
<b>Oscillator Section</b>								
Initial Accuracy	$T_J = 25^\circ C$	140	150	160	130	150	170	kHz
	$T_{MIN} \leq T_J \leq T_{MAX}$	130		170	120		180	kHz
Line Sensitivity	$V_{IN} = 5$ to $35V$		.15	.35		.15	.60	%/V
Maximum Frequency	$R_T = 10k$ , $C_T = 10pF$		5			5		MHz
Ext. Clock Low Threshold	Pin 1 ( $C_T$ ) = $V_{IN}$	0.5			0.5			V
Ext. Clock High Threshold	Pin 1 ( $C_T$ ) = $V_{IN}$			1.6			1.6	V
<b>Status Indicator Section</b>								
Input Voltage Window	@ E/A Inputs, $V_{CM} = 1.5V$	$\pm 135$	$\pm 150$	$\pm 165$	$\pm 130$	$\pm 150$	$\pm 170$	mV
Saturation Voltage	E/A $\Delta$ Input = $0V$ , $I_{SINK} = 1.6mA$			0.45			0.45	V
Max. Output Current	Pin 13 = $3V$ , E/A $\Delta$ Input = $0.0V$	8	15		8	15		mA
Leakage Current	Pin 13 = $40V$ , E/A $\Delta$ Input = $0.2V$		.05	1		.05	5	$\mu A$
Supply Current	$V_{IN} = 35V$		5	8		5	10	mA
<b>UVLO Section</b>								
Drivers Enabled Threshold	At Input Supply $V_{IN}$		3.9	4.5		3.9	4.5	V
Status Output Enabled Threshold	At Input Supply $V_{IN}$		3.9	4.5		3.9	4.5	V
Change in Reference Output	When $V_{IN}$ Reaches UVLO Threshold		-2	-30		-2	-30	mV

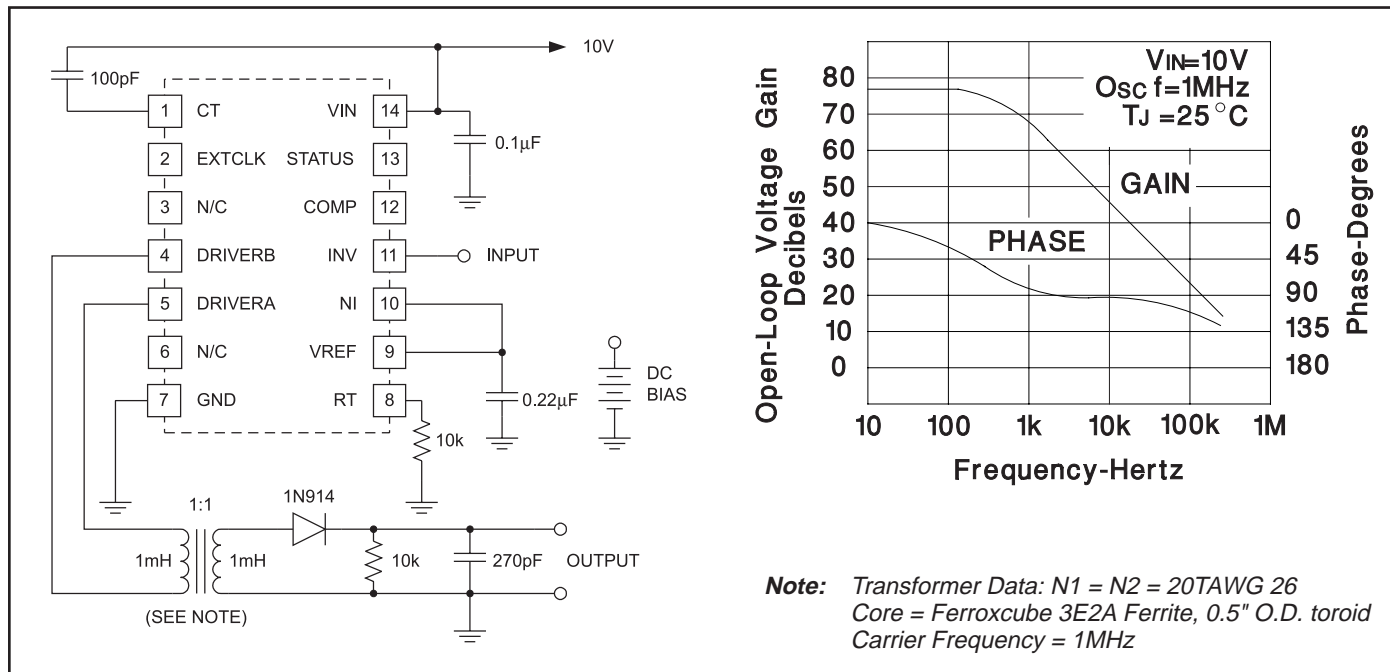

Figure 1. Transformer Coupled Open Loop Transfer Function

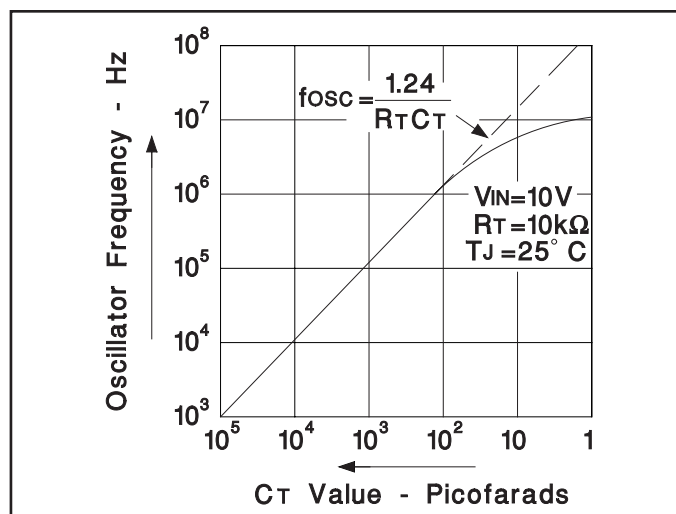

Figure 2. Oscillator Frequency

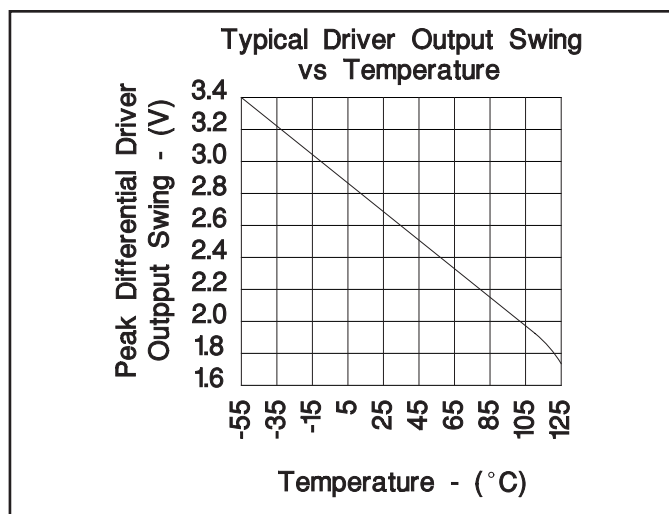

Figure 3. Typical Driver Output Swing vs Temperature

## APPLICATION INFORMATION

The error amplifier compensation terminal, Pin 12, is intended as a source of feedback to the amplifier's inverting input at Pin 11. For most applications, a series DC blocking capacitor should be part of the feedback network. The amplifier is internally compensated for unity feedback.

The waveform at the driver outputs is a squarewave with an amplitude that is proportional to the error amplifier input signal. There is a fixed 12dB of gain from the error amplifier compensation pin to the modulator driver outputs. The frequency of the output waveform is controlled by either the internal oscillator or an external clock signal.

With the internal oscillator the squarewave will have a fixed 50% duty cycle. If the internal oscillator is disabled by connecting Pin 1,  $C_R$ , to  $V_{IN}$  then the frequency and duty cycle of the output will be determined by the input clock waveform at Pin 2. If the oscillator remains disabled and there is not clock input at Pin 2, there will be a linear 12dB of signal gain to one or the other of the driver outputs depending on the DC state of Pin 2.

The driver outputs are emitter followers which will source a minimum of 15mA of current. The sink current, internally limited at 700 $\mu$ A, can be increased by adding resistors to ground at the driver outputs.

APPLICATION INFORMATION (continued)

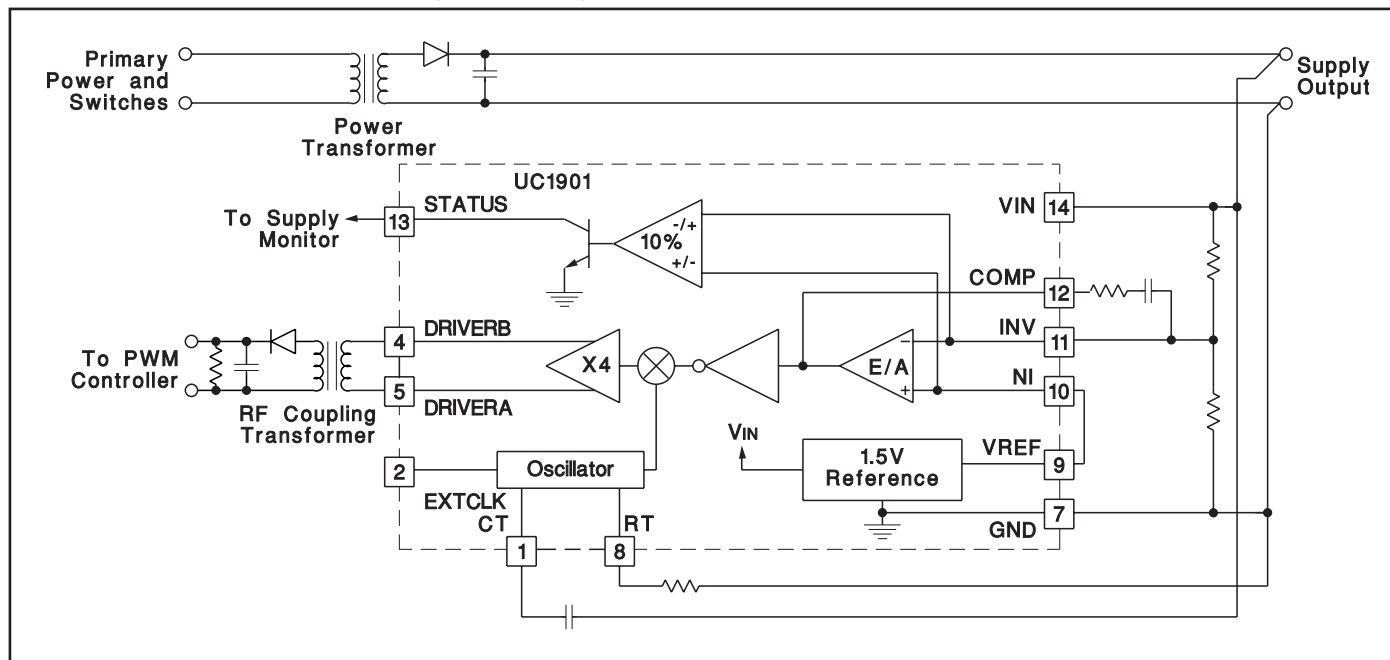

Figure 4. R.F. Transformer Coupled Feedback

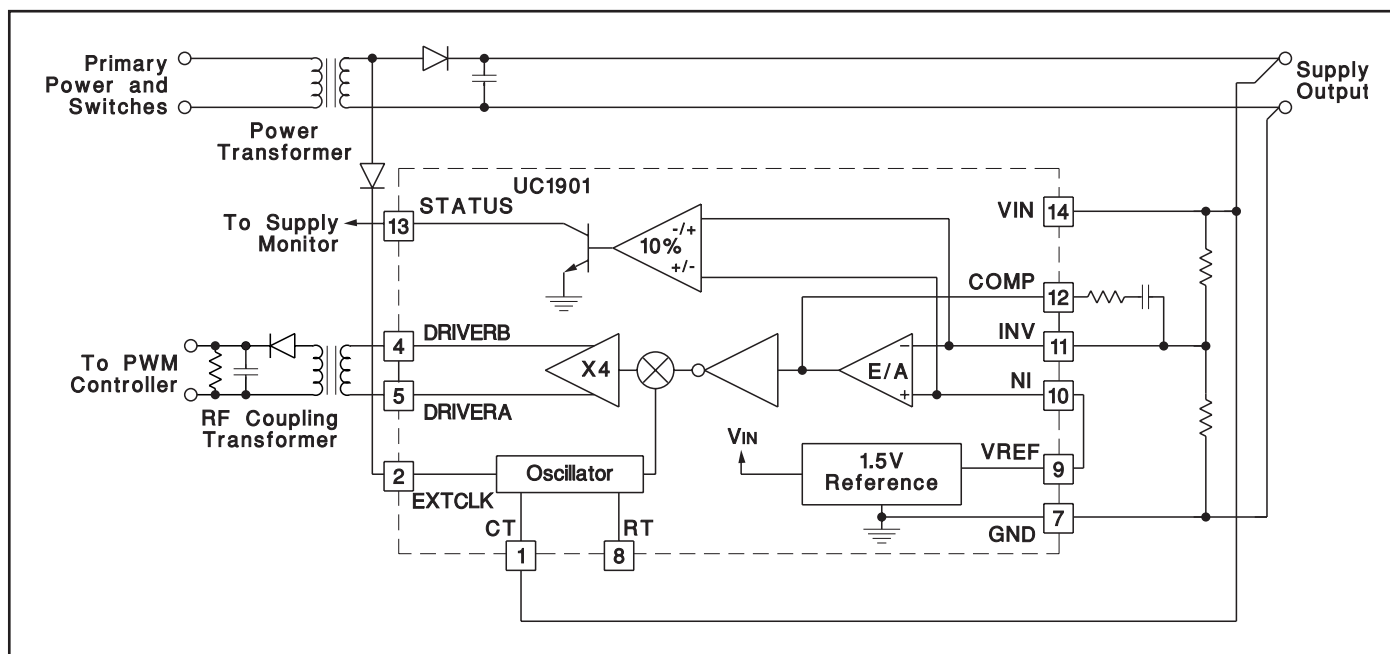

Figure 5. Feedback Coupled at Switching Frequency



**PACKAGING INFORMATION**

Orderable Device	Status <sup>(1)</sup>	Package Type	Package Drawing	Pins	Package Qty	Eco Plan <sup>(2)</sup>	Lead/ Ball Finish	MSL Peak Temp <sup>(3)</sup>	Samples (Requires Login)
5962-89441012A	ACTIVE	LCCC	FK	20	1	TBD	Call TI	Call TI	
5962-8944101CA	ACTIVE	CDIP	J	14	1	TBD	Call TI	Call TI	
5962-8944101VCA	ACTIVE	CDIP	J	14	1	TBD	A42	N / A for Pkg Type	
UC1901J	ACTIVE	CDIP	J	14	1	TBD	A42	N / A for Pkg Type	
UC1901J883B	ACTIVE	CDIP	J	14	1	TBD	A42	N / A for Pkg Type	
UC1901L	ACTIVE	LCCC	FK	20	1	TBD	POST-PLATE	N / A for Pkg Type	
UC1901L883B	ACTIVE	LCCC	FK	20	1	TBD	POST-PLATE	N / A for Pkg Type	
UC2901D	ACTIVE	SOIC	D	14	50	Green (RoHS & no Sb/Br)	CU NIPDAU	Level-2-260C-1 YEAR	
UC2901DG4	ACTIVE	SOIC	D	14	50	Green (RoHS & no Sb/Br)	CU NIPDAU	Level-2-260C-1 YEAR	
UC2901DTR	ACTIVE	SOIC	D	14	2500	Green (RoHS & no Sb/Br)	CU NIPDAU	Level-2-260C-1 YEAR	
UC2901DTR/80209	OBSOLETE	SOIC	D	14		TBD	Call TI	Call TI	
UC2901DTR/80209G4	OBSOLETE	SOIC	D	14		TBD	Call TI	Call TI	
UC2901DTRG4	ACTIVE	SOIC	D	14	2500	Green (RoHS & no Sb/Br)	CU NIPDAU	Level-2-260C-1 YEAR	
UC2901J	ACTIVE	CDIP	J	14	1	TBD	A42	N / A for Pkg Type	
UC2901N	ACTIVE	PDIP	N	14	25	Green (RoHS & no Sb/Br)	CU NIPDAU	N / A for Pkg Type	
UC2901NG4	ACTIVE	PDIP	N	14	25	Green (RoHS & no Sb/Br)	CU NIPDAU	N / A for Pkg Type	
UC2901Q	ACTIVE	PLCC	FN	20	46	Green (RoHS & no Sb/Br)	CU SN	Level-2-260C-1 YEAR	
UC2901QG3	ACTIVE	PLCC	FN	20	46	Green (RoHS & no Sb/Br)	CU SN	Level-2-260C-1 YEAR	
UC3901D	ACTIVE	SOIC	D	14	50	Green (RoHS & no Sb/Br)	CU NIPDAU	Level-2-260C-1 YEAR	
UC3901DG4	ACTIVE	SOIC	D	14	50	Green (RoHS & no Sb/Br)	CU NIPDAU	Level-2-260C-1 YEAR	
UC3901DTR	ACTIVE	SOIC	D	14	2500	Green (RoHS & no Sb/Br)	CU NIPDAU	Level-2-260C-1 YEAR	

Orderable Device	Status <sup>(1)</sup>	Package Type	Package Drawing	Pins	Package Qty	Eco Plan <sup>(2)</sup>	Lead/ Ball Finish	MSL Peak Temp <sup>(3)</sup>	Samples (Requires Login)
UC3901DTRG4	ACTIVE	SOIC	D	14	2500	Green (RoHS & no Sb/Br)	CU NIPDAU	Level-2-260C-1 YEAR	
UC3901DW	ACTIVE	SOIC	DW	16	40	Green (RoHS & no Sb/Br)	CU NIPDAU	Level-2-260C-1 YEAR	
UC3901DWG4	ACTIVE	SOIC	DW	16	40	Green (RoHS & no Sb/Br)	CU NIPDAU	Level-2-260C-1 YEAR	
UC3901DWTR	ACTIVE	SOIC	DW	16	2000	Green (RoHS & no Sb/Br)	CU NIPDAU	Level-2-260C-1 YEAR	
UC3901DWTRG4	ACTIVE	SOIC	DW	16	2000	Green (RoHS & no Sb/Br)	CU NIPDAU	Level-2-260C-1 YEAR	
UC3901N	ACTIVE	PDIP	N	14	25	Green (RoHS & no Sb/Br)	CU NIPDAU	N / A for Pkg Type	
UC3901NG4	ACTIVE	PDIP	N	14	25	Green (RoHS & no Sb/Br)	CU NIPDAU	N / A for Pkg Type	
UC3901Q	ACTIVE	PLCC	FN	20	46	Green (RoHS & no Sb/Br)	CU SN	Level-2-260C-1 YEAR	
UC3901QG3	ACTIVE	PLCC	FN	20	46	Green (RoHS & no Sb/Br)	CU SN	Level-2-260C-1 YEAR	
UC3901QTR	ACTIVE	PLCC	FN	20	1000	Green (RoHS & no Sb/Br)	CU SN	Level-2-260C-1 YEAR	
UC3901QTRG3	ACTIVE	PLCC	FN	20	1000	Green (RoHS & no Sb/Br)	CU SN	Level-2-260C-1 YEAR	

<sup>(1)</sup> The marketing status values are defined as follows:

**ACTIVE:** Product device recommended for new designs.

**LIFEBUY:** TI has announced that the device will be discontinued, and a lifetime-buy period is in effect.

**NRND:** Not recommended for new designs. Device is in production to support existing customers, but TI does not recommend using this part in a new design.

**PREVIEW:** Device has been announced but is not in production. Samples may or may not be available.

**OBSOLETE:** TI has discontinued the production of the device.

<sup>(2)</sup> Eco Plan - The planned eco-friendly classification: Pb-Free (RoHS), Pb-Free (RoHS Exempt), or Green (RoHS & no Sb/Br) - please check <http://www.ti.com/productcontent> for the latest availability information and additional product content details.

**TBD:** The Pb-Free/Green conversion plan has not been defined.

**Pb-Free (RoHS):** TI's terms "Lead-Free" or "Pb-Free" mean semiconductor products that are compatible with the current RoHS requirements for all 6 substances, including the requirement that lead not exceed 0.1% by weight in homogeneous materials. Where designed to be soldered at high temperatures, TI Pb-Free products are suitable for use in specified lead-free processes.

**Pb-Free (RoHS Exempt):** This component has a RoHS exemption for either 1) lead-based flip-chip solder bumps used between the die and package, or 2) lead-based die adhesive used between the die and leadframe. The component is otherwise considered Pb-Free (RoHS compatible) as defined above.

---

**Green (RoHS & no Sb/Br):** TI defines "Green" to mean Pb-Free (RoHS compatible), and free of Bromine (Br) and Antimony (Sb) based flame retardants (Br or Sb do not exceed 0.1% by weight in homogeneous material)

<sup>(3)</sup> MSL, Peak Temp. -- The Moisture Sensitivity Level rating according to the JEDEC industry standard classifications, and peak solder temperature.

**Important Information and Disclaimer:** The information provided on this page represents TI's knowledge and belief as of the date that it is provided. TI bases its knowledge and belief on information provided by third parties, and makes no representation or warranty as to the accuracy of such information. Efforts are underway to better integrate information from third parties. TI has taken and continues to take reasonable steps to provide representative and accurate information but may not have conducted destructive testing or chemical analysis on incoming materials and chemicals. TI and TI suppliers consider certain information to be proprietary, and thus CAS numbers and other limited information may not be available for release.

In no event shall TI's liability arising out of such information exceed the total purchase price of the TI part(s) at issue in this document sold by TI to Customer on an annual basis.

**OTHER QUALIFIED VERSIONS OF UC1901, UC1901-SP, UC2901, UC3901 :**

- Catalog: [UC3901](#), [UC1901](#)
  
- Enhanced Product: [UC2901-EP](#)
  
- Military: [UC1901](#)
  
- Space: [UC1901-SP](#), [UC1901-SP](#)

NOTE: Qualified Version Definitions:

- Catalog - TI's standard catalog product
  
- Enhanced Product - Supports Defense, Aerospace and Medical Applications
  
- Military - QML certified for Military and Defense Applications
  
- Space - Radiation tolerant, ceramic packaging and qualified for use in Space-based application

**TAPE AND REEL INFORMATION**

**QUADRANT ASSIGNMENTS FOR PIN 1 ORIENTATION IN TAPE**

\*All dimensions are nominal

Device	Package Type	Package Drawing	Pins	SPQ	Reel Diameter (mm)	Reel Width W1 (mm)	A0 (mm)	B0 (mm)	K0 (mm)	P1 (mm)	W (mm)	Pin1 Quadrant
UC2901DTR	SOIC	D	14	2500	330.0	16.4	6.5	9.0	2.1	8.0	16.0	Q1
UC3901DTR	SOIC	D	14	2500	330.0	16.4	6.5	9.0	2.1	8.0	16.0	Q1
UC3901DWTR	SOIC	DW	16	2000	330.0	16.4	10.85	10.8	2.7	12.0	16.0	Q1
UC3901QTR	PLCC	FN	20	1000	330.0	16.4	10.3	10.3	4.9	12.0	16.0	Q1

**TAPE AND REEL BOX DIMENSIONS**

\*All dimensions are nominal

Device	Package Type	Package Drawing	Pins	SPQ	Length (mm)	Width (mm)	Height (mm)
UC2901DTR	SOIC	D	14	2500	346.0	346.0	33.0
UC3901DTR	SOIC	D	14	2500	346.0	346.0	33.0
UC3901DWTR	SOIC	DW	16	2000	346.0	346.0	33.0
UC3901QTR	PLCC	FN	20	1000	346.0	346.0	33.0

## IMPORTANT NOTICE

Texas Instruments Incorporated and its subsidiaries (TI) reserve the right to make corrections, modifications, enhancements, improvements, and other changes to its products and services at any time and to discontinue any product or service without notice. Customers should obtain the latest relevant information before placing orders and should verify that such information is current and complete. All products are sold subject to TI's terms and conditions of sale supplied at the time of order acknowledgment.

TI warrants performance of its hardware products to the specifications applicable at the time of sale in accordance with TI's standard warranty. Testing and other quality control techniques are used to the extent TI deems necessary to support this warranty. Except where mandated by government requirements, testing of all parameters of each product is not necessarily performed.

TI assumes no liability for applications assistance or customer product design. Customers are responsible for their products and applications using TI components. To minimize the risks associated with customer products and applications, customers should provide adequate design and operating safeguards.

TI does not warrant or represent that any license, either express or implied, is granted under any TI patent right, copyright, mask work right, or other TI intellectual property right relating to any combination, machine, or process in which TI products or services are used. Information published by TI regarding third-party products or services does not constitute a license from TI to use such products or services or a warranty or endorsement thereof. Use of such information may require a license from a third party under the patents or other intellectual property of the third party, or a license from TI under the patents or other intellectual property of TI.

Reproduction of TI information in TI data books or data sheets is permissible only if reproduction is without alteration and is accompanied by all associated warranties, conditions, limitations, and notices. Reproduction of this information with alteration is an unfair and deceptive business practice. TI is not responsible or liable for such altered documentation. Information of third parties may be subject to additional restrictions.

Resale of TI products or services with statements different from or beyond the parameters stated by TI for that product or service voids all express and any implied warranties for the associated TI product or service and is an unfair and deceptive business practice. TI is not responsible or liable for any such statements.

TI products are not authorized for use in safety-critical applications (such as life support) where a failure of the TI product would reasonably be expected to cause severe personal injury or death, unless officers of the parties have executed an agreement specifically governing such use. Buyers represent that they have all necessary expertise in the safety and regulatory ramifications of their applications, and acknowledge and agree that they are solely responsible for all legal, regulatory and safety-related requirements concerning their products and any use of TI products in such safety-critical applications, notwithstanding any applications-related information or support that may be provided by TI. Further, Buyers must fully indemnify TI and its representatives against any damages arising out of the use of TI products in such safety-critical applications.

TI products are neither designed nor intended for use in military/aerospace applications or environments unless the TI products are specifically designated by TI as military-grade or "enhanced plastic." Only products designated by TI as military-grade meet military specifications. Buyers acknowledge and agree that any such use of TI products which TI has not designated as military-grade is solely at the Buyer's risk, and that they are solely responsible for compliance with all legal and regulatory requirements in connection with such use.

TI products are neither designed nor intended for use in automotive applications or environments unless the specific TI products are designated by TI as compliant with ISO/TS 16949 requirements. Buyers acknowledge and agree that, if they use any non-designated products in automotive applications, TI will not be responsible for any failure to meet such requirements.

Following are URLs where you can obtain information on other Texas Instruments products and application solutions:

### Products

Audio	<a href="http://www.ti.com/audio">www.ti.com/audio</a>
Amplifiers	<a href="http://amplifier.ti.com">amplifier.ti.com</a>
Data Converters	<a href="http://dataconverter.ti.com">dataconverter.ti.com</a>
DLP® Products	<a href="http://www.dlp.com">www.dlp.com</a>
DSP	<a href="http://dsp.ti.com">dsp.ti.com</a>
Clocks and Timers	<a href="http://www.ti.com/clocks">www.ti.com/clocks</a>
Interface	<a href="http://interface.ti.com">interface.ti.com</a>
Logic	<a href="http://logic.ti.com">logic.ti.com</a>
Power Mgmt	<a href="http://power.ti.com">power.ti.com</a>
Microcontrollers	<a href="http://microcontroller.ti.com">microcontroller.ti.com</a>
RFID	<a href="http://www.ti-rfid.com">www.ti-rfid.com</a>
OMAP Mobile Processors	<a href="http://www.ti.com/omap">www.ti.com/omap</a>
Wireless Connectivity	<a href="http://www.ti.com/wirelessconnectivity">www.ti.com/wirelessconnectivity</a>

### Applications

Communications and Telecom	<a href="http://www.ti.com/communications">www.ti.com/communications</a>
Computers and Peripherals	<a href="http://www.ti.com/computers">www.ti.com/computers</a>
Consumer Electronics	<a href="http://www.ti.com/consumer-apps">www.ti.com/consumer-apps</a>
Energy and Lighting	<a href="http://www.ti.com/energy">www.ti.com/energy</a>
Industrial	<a href="http://www.ti.com/industrial">www.ti.com/industrial</a>
Medical	<a href="http://www.ti.com/medical">www.ti.com/medical</a>
Security	<a href="http://www.ti.com/security">www.ti.com/security</a>
Space, Avionics and Defense	<a href="http://www.ti.com/space-avionics-defense">www.ti.com/space-avionics-defense</a>
Transportation and Automotive	<a href="http://www.ti.com/automotive">www.ti.com/automotive</a>
Video and Imaging	<a href="http://www.ti.com/video">www.ti.com/video</a>

TI E2E Community Home Page

[e2e.ti.com](http://e2e.ti.com)

Mailing Address: Texas Instruments, Post Office Box 655303, Dallas, Texas 75265  
Copyright © 2011, Texas Instruments Incorporated

## Looking for pricing, stock, or lifecycle information?

Click below to explore more details on WIN SOURCE:

 [View UC3901D on WIN SOURCE](#)

 [Texas Instruments](#) Information

## Optimize Your Supply Chain with WIN SOURCE Solutions

-  Global Sourcing Solution
-  Obsolete Management
-  Cost Control Management
-  Shortage Management
-  Alternative Solution
-  Excess Inventory Management