



THE DATASHEET OF DAC8568ICPWR



DAC7568, DAC8168, DAC8568 12-/14-/16-Bit, Octal-Channel, Ultralow Glitch, Voltage Output, Digital-to-Analog Converters with 2.5-V 2-ppm/°C Internal Reference

1 Features

- Relative Accuracy:
 - DAC7568 (12-Bit): 0.3 LSB INL
 - DAC8168 (14-Bit): 1 LSB INL
 - DAC8568 (16-Bit): 4 LSB INL
- Glitch Energy: 0.1nV-s
- Internal Reference:
 - 2.5V Reference Voltage (disabled by default)
 - 0.004% Initial Accuracy (typ)
 - 2ppm/°C Temperature Drift (typ)
 - 5ppm/°C Temperature Drift (max)
 - 20mA Sink/Source Capability
- Power-On Reset to Zero Scale or Midscale
- Ultralow Power Operation: 1.25mA at 5V Including Internal Reference Current
- Wide Power-Supply Range: +2.7V to +5.5V
- Monotonic Over Entire Temperature Range
- Low-Power Serial Interface with Schmitt-Triggered Inputs: Up to 50MHz
- On-Chip Output Buffer Amplifier with Rail-to-Rail Operation
- Temperature Range: –40°C to +125°C

2 Applications

- Portable Instrumentation
- Closed-Loop Servo-Control/Process Control
- Data Acquisition Systems
- Programmable Attenuation, Digital Gain, and Offset Adjustment
- Programmable Voltage and Current Sources

3 Description

The DAC7568, DAC8168, and DAC8568 are low-power, voltage-output, eight-channel, 12-, 14-, and 16-bit digital-to-analog converters (DACs), respectively. These devices include a 2.5V, 2ppm/°C internal reference (disabled by default), giving a full-scale output voltage range of 2.5V or 5V. The internal reference has an initial accuracy of 0.004% and can source up to 20mA at the V_{REFIN}/V_{REFOUT} pin. These devices are monotonic, providing excellent linearity and minimizing undesired code-to-code transient voltages (glitch). They use a versatile 3-wire serial interface that operates at clock rates up to 50MHz. The interface is compatible with standard SPI™, QSPI™, Microwire™, and digital signal processor (DSP) interfaces.

The DAC7568, DAC8168, and DAC8568 incorporate a power-on-reset circuit that ensures the DAC output powers up at either zero scale or midscale until a valid code is written to the device. These devices contain a power-down feature, accessed over the serial interface, that reduces current consumption to typically 0.18μA at 5V. Power consumption (including internal reference) is typically 2.9mW at 3V, reducing to less than 1μW in power-down mode. The low power consumption, internal reference, and small footprint make these devices ideal for portable, battery-operated equipment.

The [DAC7568](#), [DAC8168](#), and [DAC8568](#) are drop-in and function-compatible with each other, and are available in TSSOP-16 and TSSOP-14 packages.

Device Information⁽¹⁾

| PART NUMBER | PACKAGE | BODY SIZE (NOM) |
|-------------|------------|-------------------|
| DAC7568 | TSSOP (14) | 5.00 mm x 4.40 mm |
| | TSSOP (16) | 5.00 mm x 4.40 mm |
| DAC8168 | TSSOP (14) | 5.00 mm x 4.40 mm |
| | TSSOP (16) | 5.00 mm x 4.40 mm |
| DAC8568 | TSSOP (16) | 5.00 mm x 4.40 mm |

(1) For all available packages, see the orderable addendum at the end of the data sheet.

Block Diagram

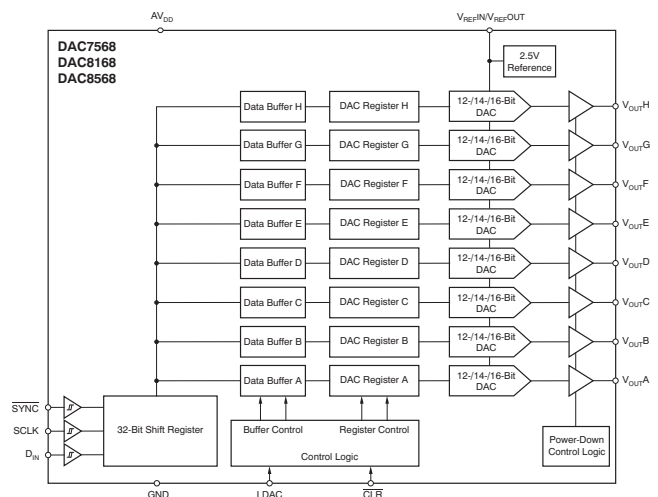

Table of Contents

| | | | |
|---|-----------|--|-----------|
| 1 Features | 1 | 8.2 Feature Description | 31 |
| 2 Applications | 1 | 8.3 Device Functional Modes | 44 |
| 3 Description | 1 | 9 Application and Implementation | 48 |
| 4 Revision History | 2 | 9.1 Application Information | 48 |
| 5 Device Comparison Table | 3 | 9.2 Typical Applications - Microprocessor Interfacing | 48 |
| 6 Pin Configuration and Functions | 4 | 10 Layout | 53 |
| 7 Specifications | 5 | 10.1 Layout Guidelines | 53 |
| 7.1 Absolute Maximum Ratings | 5 | 11 Device and Documentation Support | 54 |
| 7.2 Electrical Characteristics | 5 | 11.1 Device Support | 54 |
| 7.3 Timing Requirements | 7 | 11.2 Related Links | 57 |
| 7.4 Typical Characteristics: Internal Reference | 9 | 11.3 Receiving Notification of Documentation Updates | 57 |
| 7.5 Typical Characteristics: DAC at $V_{DD} = 5.5\text{ V}$ | 11 | 11.4 Community Resources | 57 |
| 7.6 Typical Characteristics: DAC at $V_{DD} = 3.6\text{ V}$ | 21 | 11.5 Trademarks | 57 |
| 7.7 Typical Characteristics: DAC at $V_{DD} = 2.7\text{ V}$ | 23 | 11.6 Electrostatic Discharge Caution | 57 |
| 8 Detailed Description | 31 | 11.7 Glossary | 57 |
| 8.1 Functional Block Diagram | 31 | 12 Mechanical, Packaging, and Orderable Information | 58 |

4 Revision History

NOTE: Page numbers for previous revisions may differ from page numbers in the current version.

| Changes from Revision E (January 2014) to Revision F | Page |
|---|-------------|
| • Updated data sheet to SDS standard | 1 |
| • Added External reference current grades and updated typ values | 6 |
| • Added Reference input impedance grades and updated typ values | 6 |
| • Changed I_{DD} Normal mode, internal reference switched on, $V_{DD} = 3.6\text{V}$ to 5.5V , $V_{INH} = V_{DD}$ and $V_{INL} = \text{GND}$ maximum value from 2.0mA to 2.5mA | 7 |

| Changes from Revision D (May 2012) to Revision E | Page |
|---|-------------|
| • Changed bit value in last three rows of <i>Power-Down Commands</i> section in from '0' to '1' | 38 |

| Changes from Revision C (February 2011) to Revision D | Page |
|---|-------------|
| • Changed Logic Input HIGH Voltage parameter test condition into two rows | 7 |

| Changes from Revision B (November 2010) to Revision C | Page |
|--|-------------|
| • Changed Output Voltage parameter min/max values from 2.4895 and 2.5005 to 2.4975 and 2.5025, respectively | 6 |
| • Changed Initial Accuracy parameter min/max values from -0.02 and 0.02 to -0.1 and 0.1 , respectively | 6 |

| Changes from Revision A (April 2009) to Revision B | Page |
|--|-------------|
| • Changed Logic Input LOW Voltage parameter maximum value from 0.8 to $0.3 \times V_{DD}$ | 7 |
| • Changed Logic Input HIGH Voltage parameter minimum value from 1.8 to $0.7 \times V_{DD}$ | 7 |
| • Updated Figure 122 | 33 |

5 Device Comparison Table

| PRODUCT | MAXIMUM RELATIVE ACCURACY (LSB) | MAXIMUM DIFFERENTIAL NONLINEARITY (LSB) | MAXIMUM REFERENCE DRIFT (ppm/°C) | OUTPUT VOLTAGE FULL-SCALE RANGE | RESET TO | RESOLUTION |
|----------|---------------------------------|---|----------------------------------|---------------------------------|----------|------------|
| DAC8568A | ±12 | ±1 | 25 | 2.5V | Zero | 16 |
| DAC8568B | ±12 | ±1 | 25 | 2.5V | Midscale | 16 |
| DAC8568C | ±12 | ±1 | 5 | 5V | Zero | 16 |
| DAC8568D | ±12 | ±1 | 5 | 5V | Midscale | 16 |
| DAC8168A | ±4 | ±0.5 | 25 | 2.5V | Zero | 14 |
| DAC8168C | ±4 | ±0.5 | 5 | 5V | Zero | 14 |
| DAC7568A | ±1 | ±0.25 | 25 | 2.5V | Zero | 12 |
| DAC7568C | ±1 | ±0.25 | 5 | 5V | Zero | 12 |

6 Pin Configuration and Functions

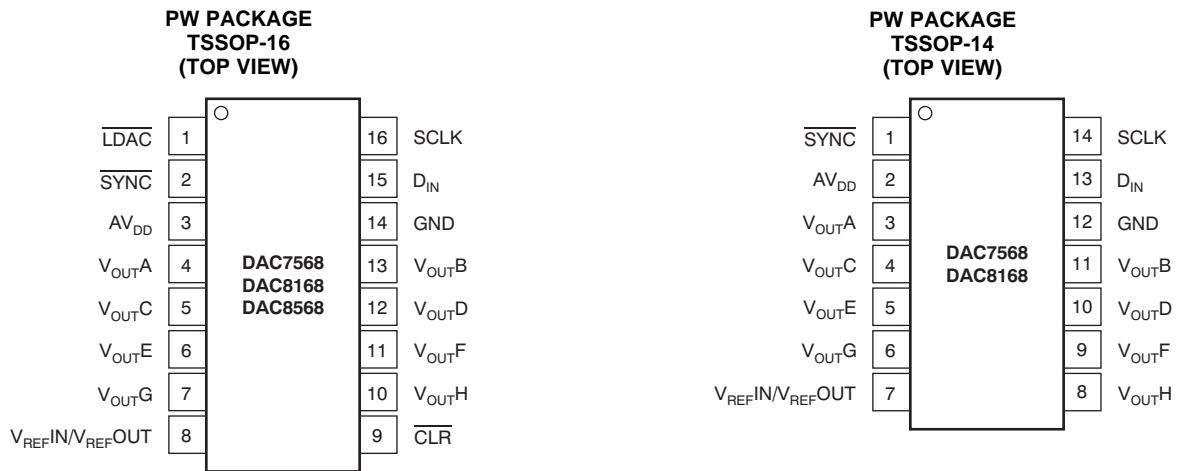

Pin Functions

| 16-PIN | 14-PIN | NAME | DESCRIPTION |
|--------|--------|---|---|
| 1 | — | $\overline{\text{LDAC}}$ | Load DACs. |
| 2 | 1 | $\overline{\text{SYNC}}$ | Level-triggered control input (active low). This input is the frame synchronization signal for the input data. When $\overline{\text{SYNC}}$ goes low, it enables the input shift register, and data are sampled on subsequent falling clock edges. The DAC output updates following the 32nd clock. If $\overline{\text{SYNC}}$ is taken high before the 31st clock edge, the rising edge of $\overline{\text{SYNC}}$ acts as an interrupt, and the write sequence is ignored by the DAC7568/DAC8168/DAC8568. Schmitt-Trigger logic input. |
| 3 | 2 | AV _{DD} | Power-supply input, 2.7V to 5.5V |
| 4 | 3 | V _{OUTA} | Analog output voltage from DAC A |
| 5 | 4 | V _{OUTC} | Analog output voltage from DAC C |
| 6 | 5 | V _{OUTE} | Analog output voltage from DAC E |
| 7 | 6 | V _{OUTG} | Analog output voltage from DAC G |
| 8 | 7 | V _{REFIN} / V _{REFOUT} | Positive reference input / reference output 2.5V if internal reference used. ⁽¹⁾ |
| 9 | — | $\overline{\text{CLR}}$ | Asynchronous clear input. |
| 10 | 8 | V _{OUTH} | Analog output voltage from DAC H |
| 11 | 9 | V _{OUTF} | Analog output voltage from DAC F |
| 12 | 10 | V _{OUTD} | Analog output voltage from DAC D |
| 13 | 11 | V _{OUTB} | Analog output voltage from DAC B |
| 14 | 12 | GND | Ground reference point for all circuitry on the device |
| 15 | 13 | D _{IN} | Serial data input. Data are clocked into the 32-bit input shift register on each falling edge of the serial clock input. Schmitt-Trigger logic input. |
| 16 | 14 | SCLK | Serial clock input. Data can be transferred at rates up to 50MHz. Schmitt-Trigger logic input. |

(1) Grades A and B, external V_{REFIN} (max) ≤ AV_{DD}; grades C and D, external V_{REFIN} (max) ≤ AV_{DD}/2.

7 Specifications

7.1 Absolute Maximum Ratings⁽¹⁾

Over operating free-air temperature range (unless otherwise noted).

| PARAMETER | MIN | MAX | UNIT |
|---|--|------------------------|------|
| AV _{DD} to GND | -0.3 | 6 | V |
| Digital input voltage to GND | -0.3 | AV _{DD} + 0.3 | V |
| V _{OUT} to GND | -0.3 | AV _{DD} + 0.3 | V |
| V _{REF} to GND | -0.3 | AV _{DD} + 0.3 | V |
| Operating temperature range | -40 | 125 | °C |
| Storage temperature range | -65 | 150 | °C |
| Junction temperature range (T _J max) | | 150 | °C |
| Power dissipation | (T _J max – T _A)/θ _{JA} | | W |
| Thermal impedance, R _{θJA} | 118 | | °C/W |
| Thermal impedance, R _{θJC} | 29 | | °C/W |

(1) Stresses beyond those listed under *Absolute Maximum Ratings* may cause permanent damage to the device. These are stress ratings only, which do not imply functional operation of the device at these or any other conditions beyond those indicated under *Recommended Operating Conditions*. Exposure to absolute-maximum-rated conditions for extended periods may affect device reliability.

7.2 Electrical Characteristics

At AV_{DD} = 2.7V to 5.5V and over -40°C to +125°C (unless otherwise noted).

| PARAMETER | TEST CONDITIONS | MIN | TYP | MAX | UNIT | |
|---|--|--|-------|-------|---------------|-----|
| STATIC PERFORMANCE⁽¹⁾ | | | | | | |
| DAC8568 | Resolution | 16 | | | Bits | |
| | Relative accuracy | Measured by the line passing through codes 485 and 64714 | | ±4 | ±12 | LSB |
| | Differential nonlinearity | 16-bit monotonic | | ±0.2 | ±1 | LSB |
| DAC8168 | Resolution | 14 | | | Bits | |
| | Relative accuracy | Measured by the line passing through codes 120 and 16200 | | ±1 | ±4 | LSB |
| | Differential nonlinearity | 14-bit monotonic | | ±0.1 | ±0.5 | LSB |
| DAC7568 | Resolution | 12 | | | Bits | |
| | Relative accuracy | Measured by the line passing through codes 30 and 4050 | | ±0.3 | ±1 | LSB |
| | Differential nonlinearity | 12-bit monotonic | | ±0.05 | ±0.25 | LSB |
| Offset error | Extrapolated from two-point line ⁽¹⁾ , unloaded | | ±1 | ±4 | mV | |
| Offset error drift | | | ±0.5 | | μV/°C | |
| Full-scale error | DAC register loaded with all '1's | | ±0.03 | ±0.2 | % of FSR | |
| Zero-code error | DAC register loaded with all '0's | | 1 | 4 | mV | |
| Zero-code error drift | | | ±2 | | μV/°C | |
| Gain error | Extrapolated from two-point line ⁽¹⁾ , unloaded | | ±0.01 | ±0.15 | % of FSR | |
| Gain temperature coefficient | | | ±1 | | ppm of FSR/°C | |

(1) 16-bit: codes 485 and 64714; 14-bit: codes 120 and 16200; 12-bit: codes 30 and 4050

Electrical Characteristics (continued)

 At $V_{DD} = 2.7V$ to $5.5V$ and over $-40^{\circ}C$ to $+125^{\circ}C$ (unless otherwise noted).

| PARAMETER | TEST CONDITIONS | MIN | TYP | MAX | UNIT |
|---|--|------------|-------------|-------------|------------------|
| OUTPUT CHARACTERISTICS⁽²⁾ | | | | | |
| Output voltage range | $AV_{DD} \geq 2.7V$; grades A and B: maximum output voltage 2.5V when using internal reference | 0 | | AV_{DD} | V |
| | $AV_{DD} \geq 5V$; grades C and D: maximum output voltage 5V when using internal reference | | | | |
| Output voltage settling time | DACs unloaded; 1/4 scale to 3/4 scale to $\pm 0.024\%$ | | 5 | 10 | μs |
| | $R_L = 1M\Omega$ | | 10 | | |
| Slew rate | | | 0.75 | | V/ μs |
| Capacitive load stability | $R_L = \infty$ | | 1000 | | pF |
| | $R_L = 2k\Omega$ | | 3000 | | |
| Code change glitch impulse | 1LSB change around major carry | | 0.1 | | nV-s |
| Digital feedthrough | SCLK toggling, \overline{SYNC} high | | 0.1 | | nV-s |
| Power-on glitch impulse | $R_L = 2k\Omega$, $C_L = 470pF$, $AV_{DD} = 5.5V$ | | 10 | | mV |
| | $R_L = 2k\Omega$, $C_L = 470pF$, $AV_{DD} = 2.7V$ | | 6 | | mV |
| Channel-to-channel dc crosstalk | Full-scale swing on adjacent channel | | 0.1 | | LSB |
| Channel-to-channel ac crosstalk | $R_L = 2k\Omega$, $C_L = 420pF$, 1kHz full-scale sine wave, outputs unloaded | | -109 | | dB |
| DC output impedance | At mid-code input | | 4 | | Ω |
| Short-circuit current | DAC outputs at full-scale, DAC outputs shorted to GND | | 11 | | mA |
| Power-up time, including settling time | Coming out of power-down mode | | 50 | | μs |
| AC PERFORMANCE⁽²⁾ | | | | | |
| SNR | $T_A = +25^{\circ}C$, BW = 20kHz, $AV_{DD} = 5V$, $f_{OUT} = 1kHz$, first 19 harmonics removed for SNR calculation, at 16-bit level | | 83 | | dB |
| THD | | | -63 | | dB |
| SFDR | | | 63 | | dB |
| SINAD | | | 62 | | dB |
| DAC output noise density | $T_A = +25^{\circ}C$, at zero-code input, $f_{OUT} = 1kHz$ | | 90 | | nV/ \sqrt{Hz} |
| DAC output noise | $T_A = +25^{\circ}C$, at mid-code input, 0.1Hz to 10Hz | | 2.6 | | μV_{PP} |
| REFERENCE | | | | | |
| Internal reference current consumption | $AV_{DD} = 5.5V$ | | 360 | | μA |
| | $AV_{DD} = 3.6V$ | | 348 | | μA |
| External reference current | External $V_{REF} = 2.5V$ (when internal reference is disabled), all eight channels active | Grades A/B | 60 | | μA |
| | | Grades C/D | 115 | | |
| V_{REFIN} Reference input range | Grades A/B, $AV_{DD} = 2.7V$ to $5.5V$ | 0 | | AV_{DD} | V |
| | Grades C/D, $AV_{DD} = 5.0V$ to $5.5V$ | 0 | | $AV_{DD}/2$ | V |
| Reference input impedance | Grades A/B | | 44 | | k Ω |
| | Grades C/D | | 22 | | |
| REFERENCE OUTPUT | | | | | |
| Output voltage | $T_A = +25^{\circ}C$; all grades | 2.4975 | 2.5 | 2.5025 | V |
| Initial accuracy | $T_A = +25^{\circ}C$, all grades | -0.1 | ± 0.004 | 0.1 | % |
| Output voltage temperature drift | DAC7568/DAC8168/DAC8568 ⁽³⁾ , grades A/B | | 5 | 25 | ppm/ $^{\circ}C$ |
| | DAC7568/DAC8168/DAC8568 ⁽⁴⁾ , grades C/D | | 2 | 5 | |
| Output voltage noise | $f = 0.1Hz$ to $10Hz$ | | 12 | | μV_{PP} |
| Output voltage noise density (high-frequency noise) | $T_A = +25^{\circ}C$, $f = 1MHz$, $C_L = 0\mu F$ | | 50 | | nV/ \sqrt{Hz} |
| | $T_A = +25^{\circ}C$, $f = 1MHz$, $C_L = 1\mu F$ | | 20 | | |
| | $T_A = +25^{\circ}C$, $f = 1MHz$, $C_L = 4\mu F$ | | 16 | | |
| Load regulation, sourcing ⁽⁵⁾ | $T_A = +25^{\circ}C$ | | 30 | | $\mu V/mA$ |
| Load regulation, sinking ⁽⁵⁾ | $T_A = +25^{\circ}C$ | | 15 | | $\mu V/mA$ |

(2) Specified by design or characterization; not production tested.

 (3) Reference is trimmed and tested at room temperature, and is characterized from $-40^{\circ}C$ to $+125^{\circ}C$.

 (4) Reference is trimmed and tested at two temperatures ($+25^{\circ}C$ and $+105^{\circ}C$), and is characterized from $-40^{\circ}C$ to $+125^{\circ}C$.

 (5) Explained in more detail in the [Application Information](#) section of this data sheet.

Electrical Characteristics (continued)

 At $V_{DD} = 2.7V$ to $5.5V$ and over $-40^{\circ}C$ to $+125^{\circ}C$ (unless otherwise noted).

| PARAMETER | | TEST CONDITIONS | MIN | TYP | MAX | UNIT |
|--|--|---|-----|-----------------------|---------------------|------|
| Output current load capability ⁽²⁾ | | | | ±20 | | mA |
| Line regulation | | $T_A = +25^{\circ}C$ | | 10 | | μV/V |
| Long-term stability/drift (aging) ⁽⁵⁾ | | $T_A = +25^{\circ}C$, time = 0 to 1900 hours | | 50 | | ppm |
| Thermal hysteresis ⁽⁵⁾ | | First cycle | | 100 | | ppm |
| | | Additional cycles | | 25 | | |
| LOGIC INPUTS⁽²⁾ | | | | | | |
| Input current | | | | ±1 | | μA |
| V_{INL} | Logic input LOW voltage | $2.7V \leq V_{DD} \leq 5.5V$ | | | $0.3 \times V_{DD}$ | V |
| V_{INH} | Logic input HIGH voltage | $2.7V \leq V_{DD} < 4.5V$ | | $0.7 \times V_{DD}$ | | V |
| | | $4.5V \leq V_{DD} \leq 5.5V$ | | $0.625 \times V_{DD}$ | | V |
| Pin capacitance | | | | | 3 | pF |
| POWER REQUIREMENTS | | | | | | |
| V_{DD} | | | 2.7 | | 5.5 | V |
| I_{DD} ⁽⁶⁾ | Normal mode, internal reference switched off | $V_{DD} = 3.6V$ to $5.5V$ $V_{INH} = V_{DD}$ and $V_{INL} = GND$ | | 0.95 | 1.4 | mA |
| | | $V_{DD} = 2.7V$ to $3.6V$ $V_{INH} = V_{DD}$ and $V_{INL} = GND$ | | 0.81 | 1.3 | |
| | Normal mode, internal reference switched on | $V_{DD} = 3.6V$ to $5.5V$ $V_{INH} = V_{DD}$ and $V_{INL} = GND$ | | 1.25 | 2.5 | mA |
| | | $V_{DD} = 2.7V$ to $3.6V$ $V_{INH} = V_{DD}$ and $V_{INL} = GND$ | | 1.1 | 1.9 | |
| | All power-down modes | $V_{DD} = 3.6V$ to $5.5V$ $V_{INH} = V_{DD}$ and $V_{INL} = GND$ | | 0.18 | 3 | μA |
| | | $V_{DD} = 2.7V$ to $3.6V$ $V_{INH} = V_{DD}$ and $V_{INL} = GND$ | | 0.10 | 2.5 | |
| Power dissipation ⁽⁶⁾ | Normal mode, internal reference switched off | $V_{DD} = 3.6V$ to $5.5V$ $V_{INH} = V_{DD}$ and $V_{INL} = GND$ | | 3.4 | 7.7 | mW |
| | | $V_{DD} = 2.7V$ to $3.6V$ $V_{INH} = V_{DD}$ and $V_{INL} = GND$ | | 2.2 | 4.7 | |
| | Normal mode, internal reference switched on | $V_{DD} = 3.6V$ to $5.5V$ $V_{INH} = V_{DD}$ and $V_{INL} = GND$ | | 4.5 | 11 | mW |
| | | $V_{DD} = 2.7V$ to $3.6V$ $V_{INH} = V_{DD}$ and $V_{INL} = GND$ | | 2.9 | 6.8 | |
| | All power-down modes | $V_{DD} = 3.6V$ to $5.5V$ $V_{INH} = V_{DD}$ and $V_{INL} = GND$ | | 0.6 | 16 | μW |
| | | $V_{DD} = 2.7V$ to $3.6V$ $V_{INH} = V_{DD}$ and $V_{INL} = GND$ | | 0.3 | 9 | |
| TEMPERATURE RANGE | | | | | | |
| Specified performance | | | -40 | | +125 | °C |

(6) Input code = midscale, no load.

7.3 Timing Requirements^{(1) (2)}

 At $V_{DD} = 2.7V$ to $5.5V$ and over $-40^{\circ}C$ to $+125^{\circ}C$ (unless otherwise noted).

| PARAMETER | | TEST CONDITIONS | MIN | TYP | MAX | UNIT |
|--------------|--|---------------------------|-----|-----|-----|------|
| t_1 | SCLK falling edge to \overline{SYNC} falling edge (for successful write operation) | $V_{DD} = 2.7V$ to $5.5V$ | 10 | | | ns |
| t_2 (3) | SCLK cycle time | $V_{DD} = 2.7V$ to $5.5V$ | 20 | | | ns |
| t_3 | \overline{SYNC} rising edge to 31st SCLK falling edge (for successful \overline{SYNC} interrupt) | $V_{DD} = 2.7V$ to $5.5V$ | 13 | | | ns |
| t_4 | Minimum \overline{SYNC} HIGH time | $V_{DD} = 2.7V$ to $5.5V$ | 80 | | | ns |

 (1) All input signals are specified with $t_R = t_F = 3ns$ (10% to 90% of V_{DD}) and timed from a voltage level of $(V_{IL} + V_{IH})/2$.

 (2) See the [Serial Write Operation](#) timing diagram.

 (3) Maximum SCLK frequency is 50MHz at $V_{DD} = 2.7V$ to $5.5V$.

Timing Requirements^{(1) (2)} (continued)

At $V_{DD} = 2.7V$ to $5.5V$ and over $-40^{\circ}C$ to $+125^{\circ}C$ (unless otherwise noted).

| PARAMETER | TEST CONDITIONS | MIN | TYP | MAX | UNIT |
|-----------|---|-----|-----|----------------|------|
| t_5 | \overline{SYNC} to SCLK falling edge setup time | | | 13 | ns |
| t_6 | SCLK LOW time | | | 8 | ns |
| t_7 | SCLK HIGH time | | | 8 | ns |
| t_8 | SCLK falling edge to \overline{SYNC} rising edge | | | 10 | ns |
| t_9 | Data setup time | | | 6 | ns |
| t_{10} | Data hold time | | | 4 | ns |
| t_{11} | SCLK falling edge to \overline{LDAC} falling edge for asynchronous LDAC update mode | | | 40 | ns |
| t_{12} | \overline{LDAC} pulse width LOW time | | | 80 | ns |
| t_{13} | \overline{LDAC} falling edge to SCLK falling edge for synchronous LDAC update mode | | | $4 \times t_1$ | ns |
| t_{14} | 32nd SCLK falling edge to \overline{LDAC} rising edge | | | 40 | ns |
| t_{15} | \overline{CLR} pulse width LOW time | | | 80 | ns |

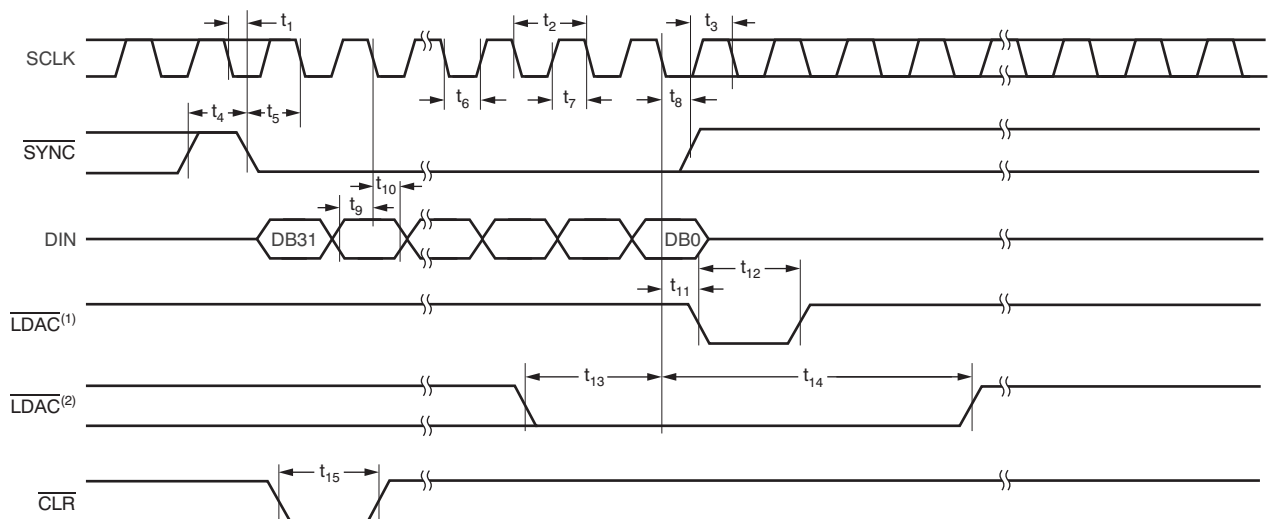

- (1) Asynchronous LDAC update mode. For more information and details, see the [LDAC Functionality](#) section.
- (2) Synchronous LDAC update mode. For more information and details, see the [LDAC Functionality](#) section.

Figure 1. Serial Write Operation

7.4 Typical Characteristics: Internal Reference

At $T_A = +25^\circ\text{C}$, unless otherwise noted.

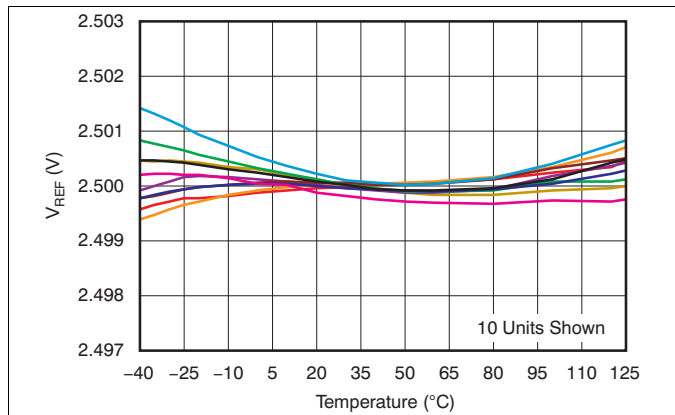

Figure 2. Internal Reference voltage vs Temperature (Grades C and D)

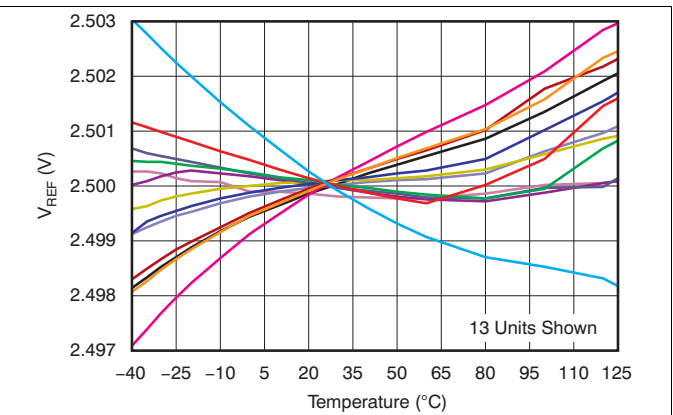

Figure 3. Internal Reference Voltage vs temperature (Grades A and B)

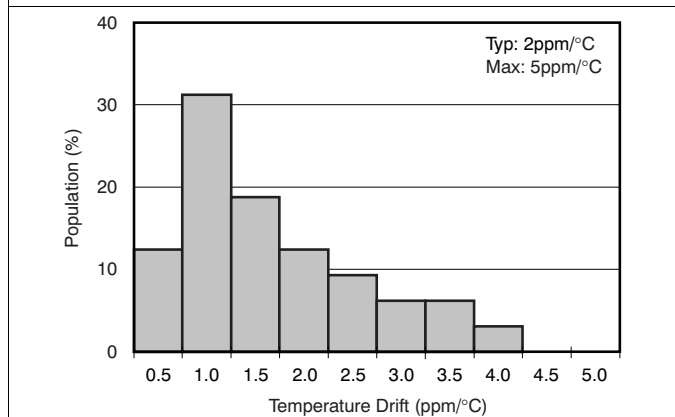

Figure 4. Reference Output Temperature Drift (-40°C to +125°C, Grades C and D)

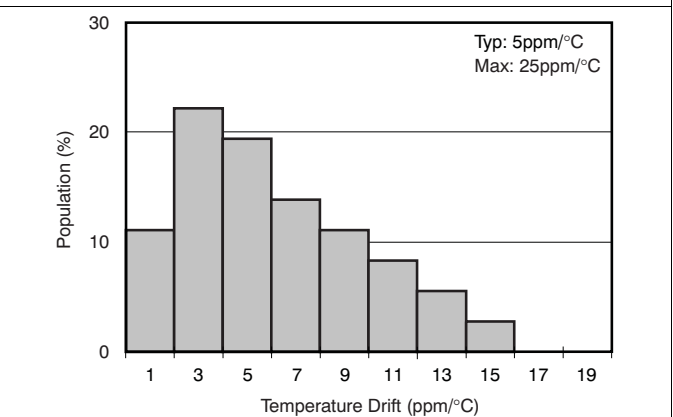

Figure 5. Reference Output Temperature Drift (-40°C to +125°, Grades A and B)

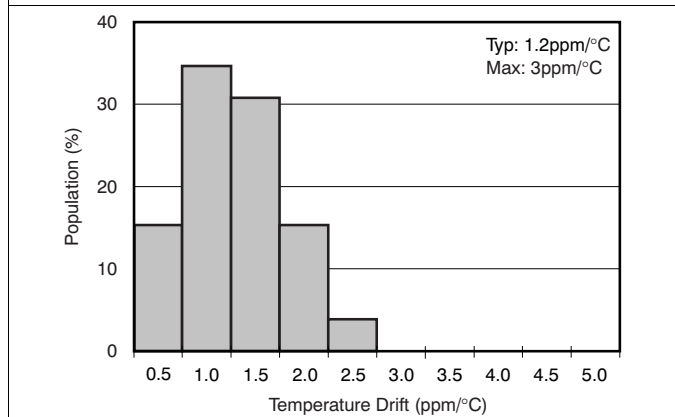
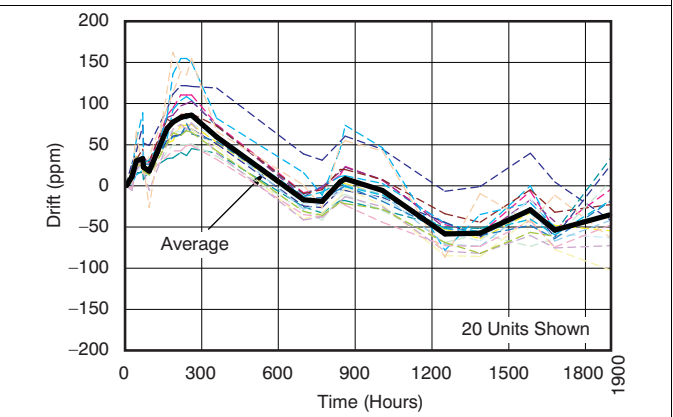

Figure 6. Reference Output Temperature Drift (0°C to +125°C, Grades C and D)



See the [Application Information](#) section of this data sheet for more details.

Figure 7. Long-Term Stability/Drift

Typical Characteristics: Internal Reference (continued)

At $T_A = +25^\circ\text{C}$, unless otherwise noted.

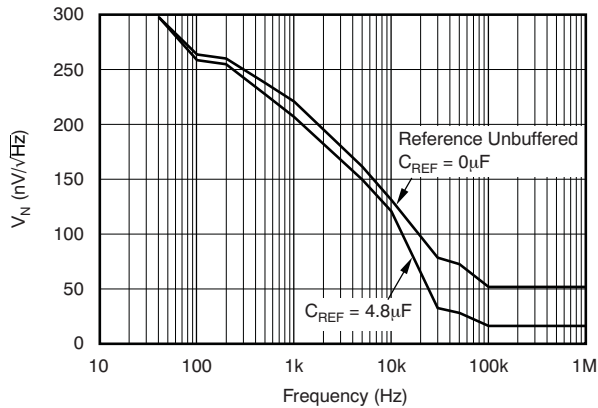

See the [Application Information](#) section of this data sheet for more details.

Figure 8. Internal Reference Noise Density vs Frequency

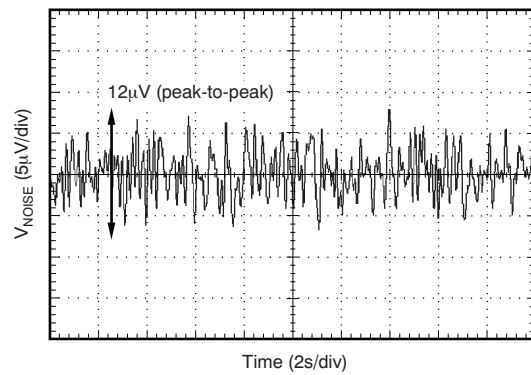

See the [Application Information](#) section of this data sheet for more details.

Figure 9. Internal Reference Noise 0.1 Hz to 10 Hz

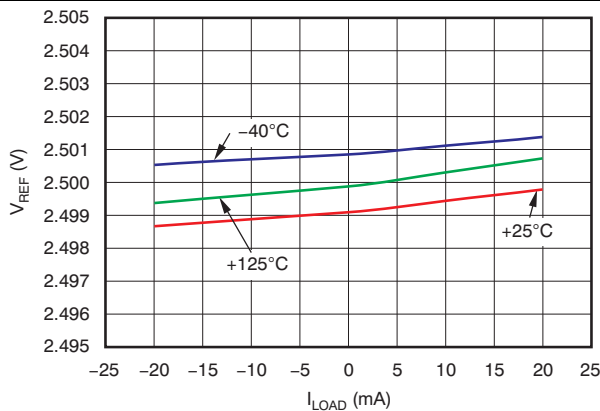

Figure 10. Internal Reference Voltage vs Load Current (Grades C and D)

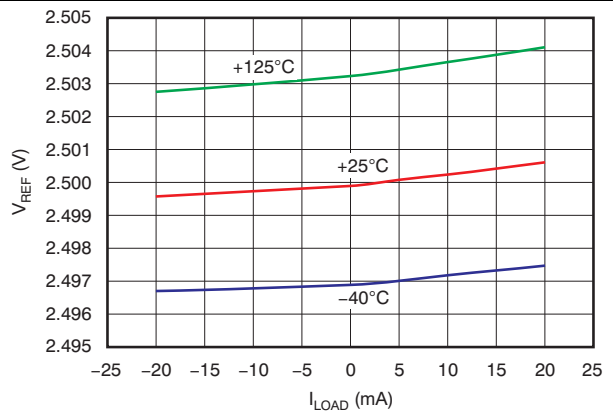

Figure 11. Internal Reference Voltage vs Load Current (Grades A and B)

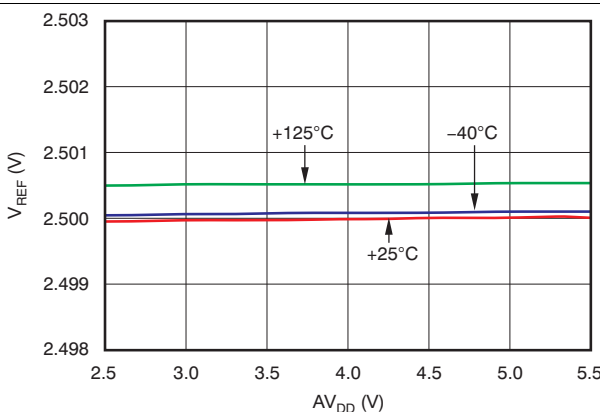

Figure 12. Internal Reference Voltage vs Supply Voltage (Grades C and D)

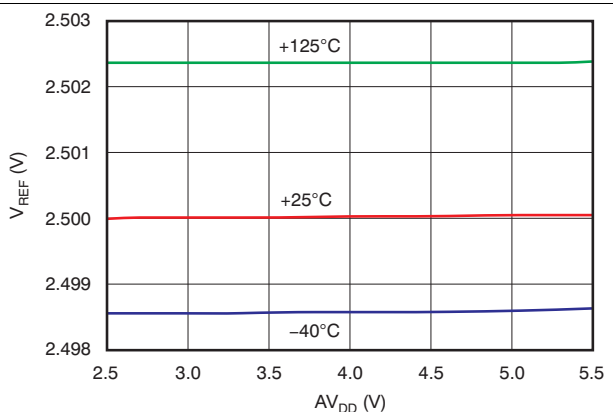

Figure 13. Internal Reference Voltage vs Supply Voltage (Grades A and B)

7.5 Typical Characteristics: DAC at $AV_{DD} = 5.5\text{ V}$

Channel-specific information provided as examples. At $T_A = +25^\circ\text{C}$, external reference used, DAC output not loaded, and all DAC codes in straight binary data format, unless otherwise noted.

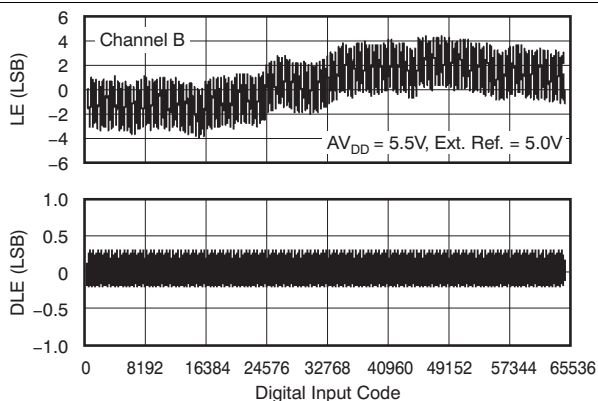

Figure 14. Linearity Error and Differential Linearity Error vs Digital Input Code (-40°C)

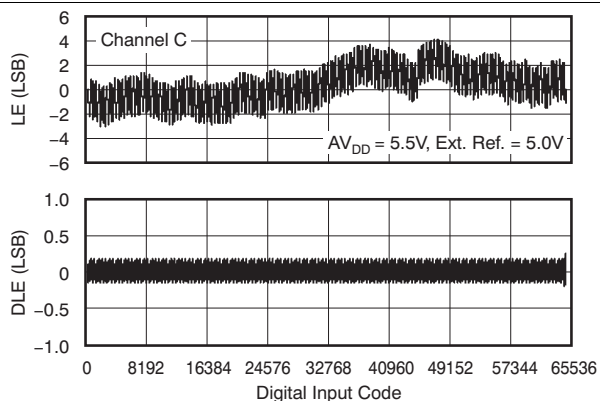

Figure 15. Linearity Error and Differential Linearity Error vs Digital Input Code (-40°C)

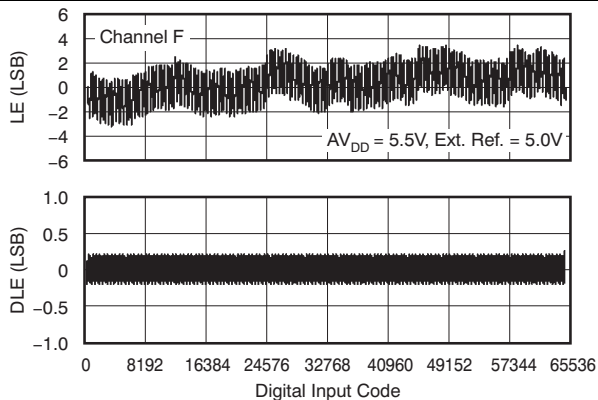

Figure 16. Linearity Error and Differential Linearity Error vs Digital Input Code (-40°C)

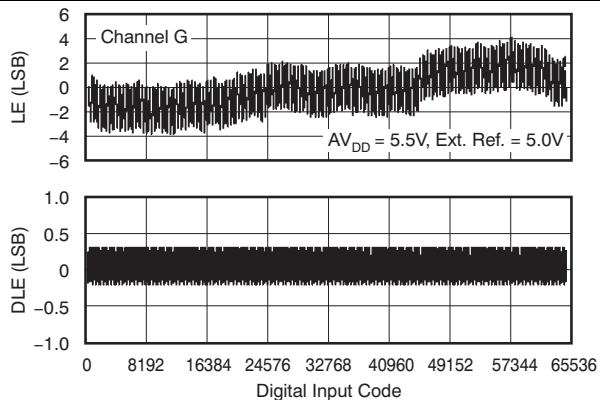

Figure 17. Linearity Error and Differential Linearity Error vs Digital Input Code (-40°C)

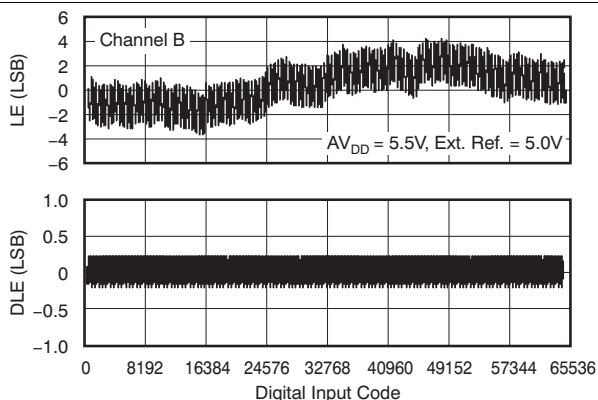

Figure 18. Linearity Error and Differential Linearity Error vs Digital Input Code ($+25^\circ\text{C}$)

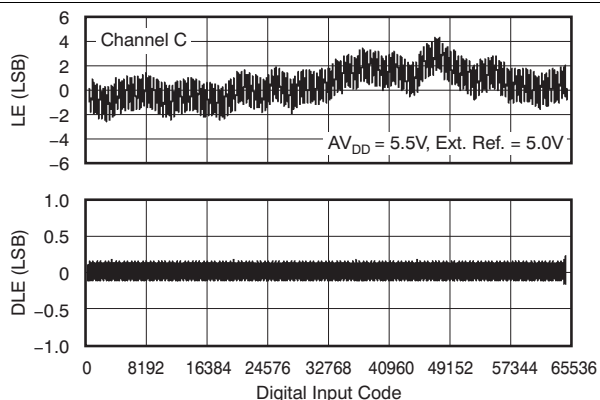

Figure 19. Linearity Error and Differential Linearity Error vs Digital Input Code ($+25^\circ\text{C}$)

Typical Characteristics: DAC at $AV_{DD} = 5.5\text{ V}$ (continued)

Channel-specific information provided as examples. At $T_A = +25^\circ\text{C}$, external reference used, DAC output not loaded, and all DAC codes in straight binary data format, unless otherwise noted.

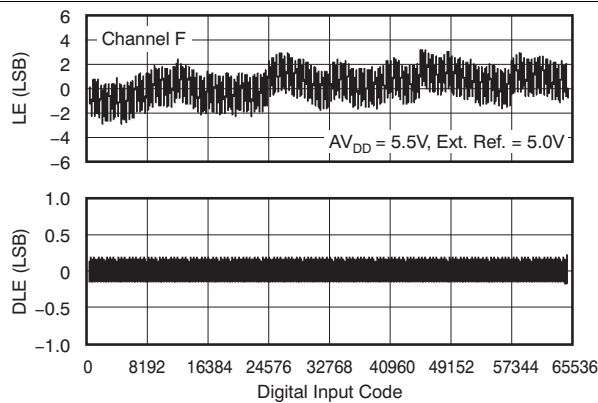

Figure 20. Linearity Error and Differential Linearity Error vs Digital Input Code (+25°C)

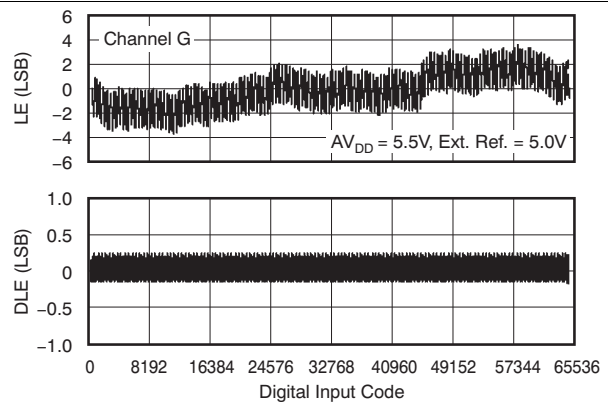

Figure 21. Linearity Error and Differential Linearity Error vs Digital Input Code (+25°C)

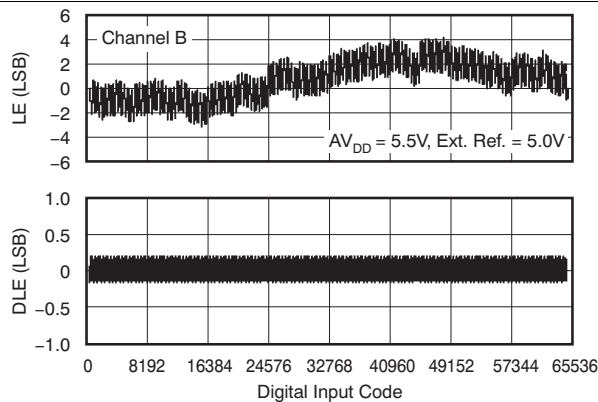

Figure 22. Linearity Error and Differential Linearity Error vs Digital Input Code (+125°C)

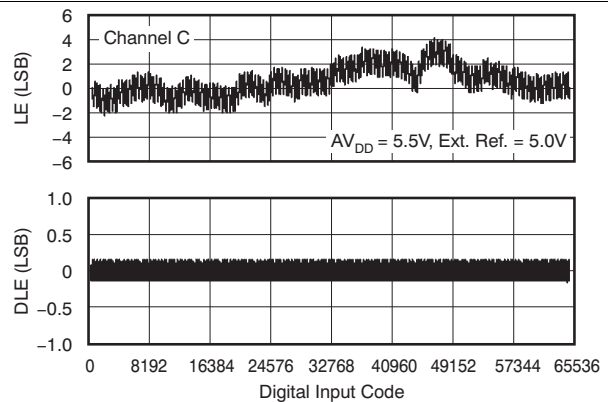

Figure 23. Linearity Error and Differential Linearity Error vs Digital Input Code (+125°C)

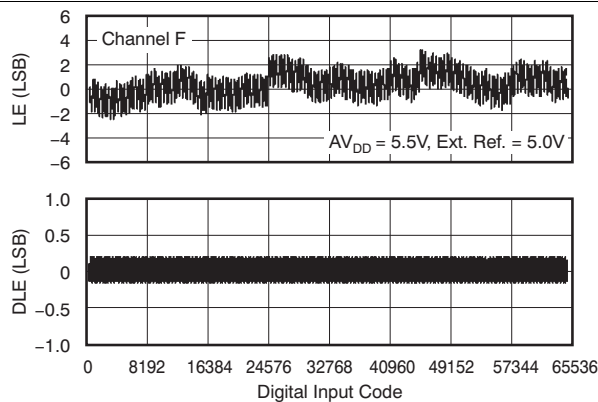

Figure 24. Linearity Error and Differential Linearity Error vs Digital Input Code (+125°C)

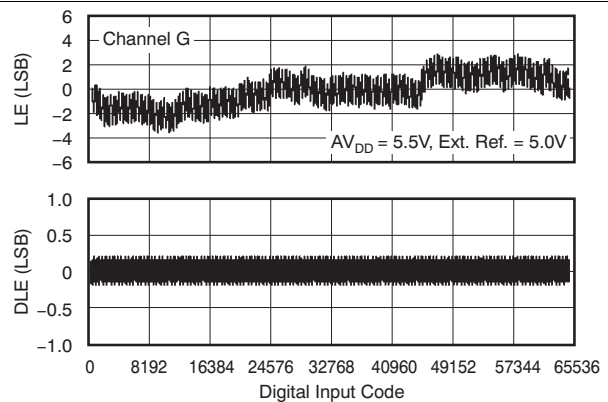

Figure 25. Linearity Error and Differential Linearity Error vs Digital Input Code (+125°C)

Typical Characteristics: DAC at AV_{DD} = 5.5 V (continued)

Channel-specific information provided as examples. At T_A = +25°C, external reference used, DAC output not loaded, and all DAC codes in straight binary data format, unless otherwise noted.

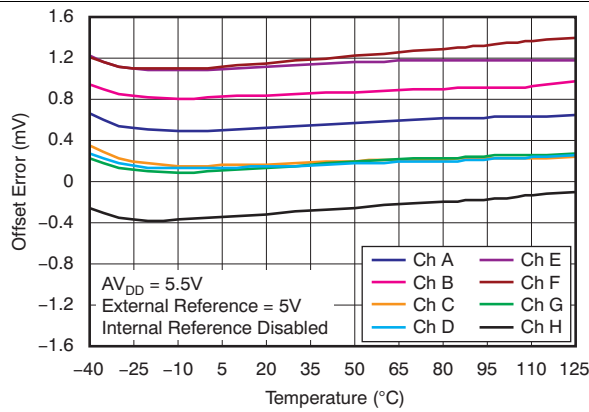

Figure 26. Offset Error vs Temperature

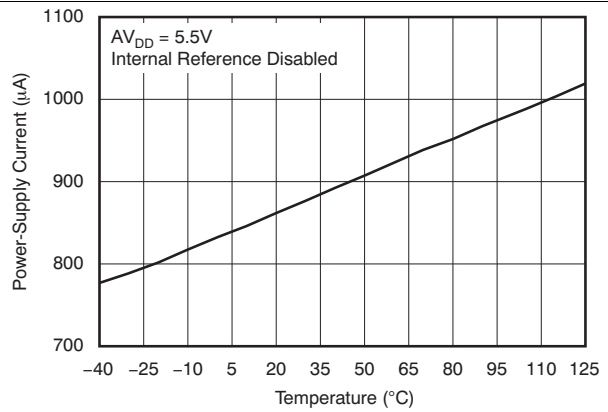

Figure 27. Power-Supply Current vs Temperature

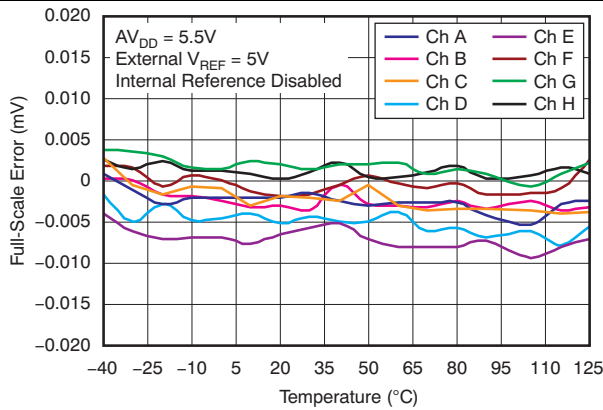

Figure 28. Full-Scale Error vs Temperature

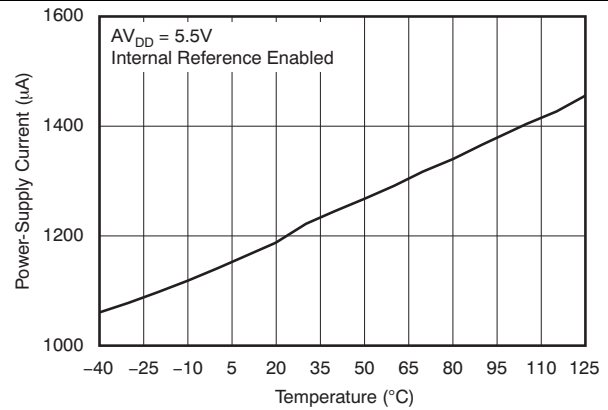

Figure 29. Power-Supply Current vs Temperature

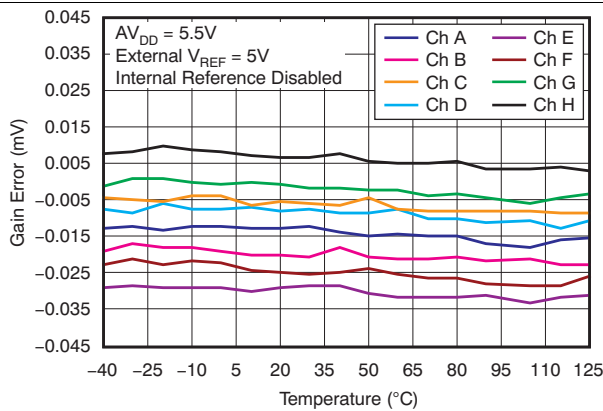

Figure 30. Gain Error vs Temperature

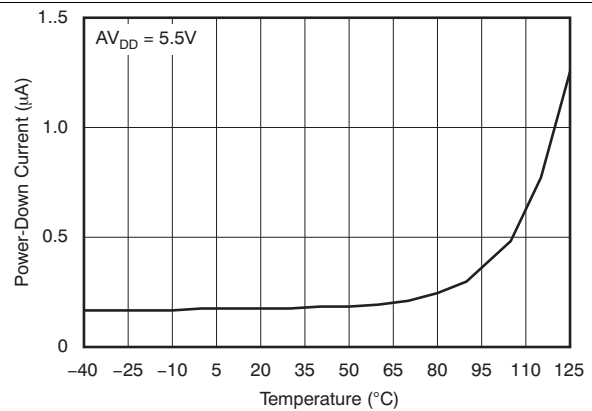

Figure 31. Power-Down Current vs Temperature

Typical Characteristics: DAC at $V_{DD} = 5.5\text{ V}$ (continued)

Channel-specific information provided as examples. At $T_A = +25^\circ\text{C}$, external reference used, DAC output not loaded, and all DAC codes in straight binary data format, unless otherwise noted.

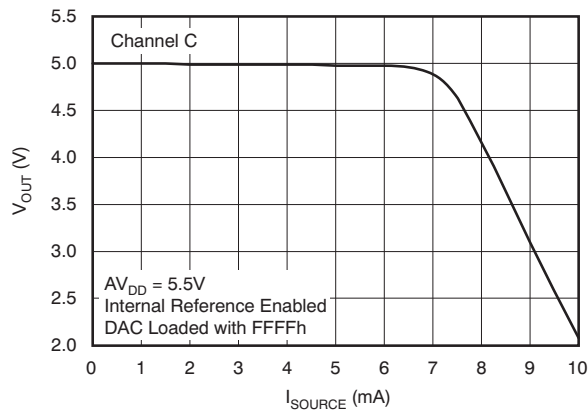

Figure 32. Source Current at Positive Rail (Grades C and D)

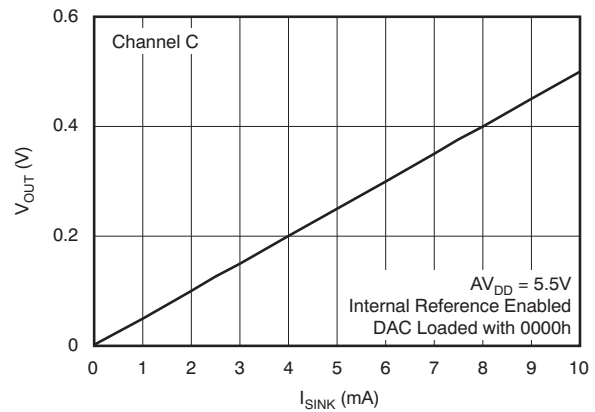

Figure 33. Sink Current at Negative Rail (All Grades)

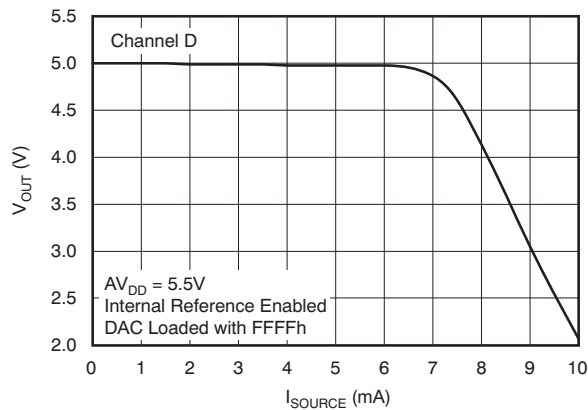

Figure 34. Source Current at Positive Rail (Grades C and D)

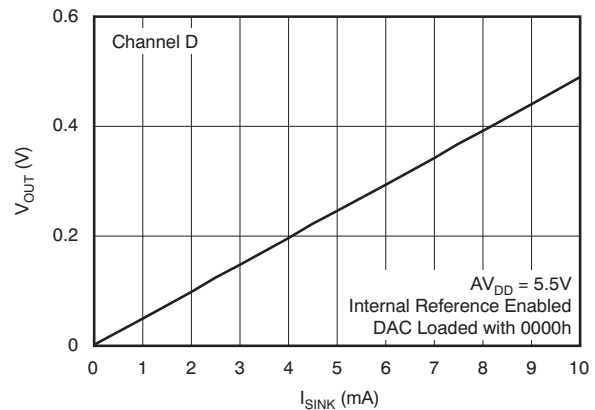

Figure 35. Sink Current at Negative Rail (All Grades)

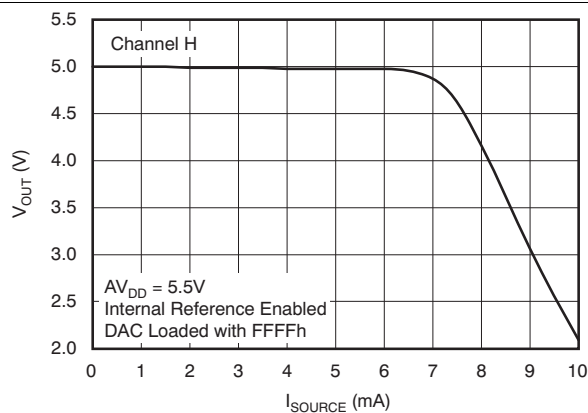

Figure 36. Source Current at Positive Rail (Grades C and D)

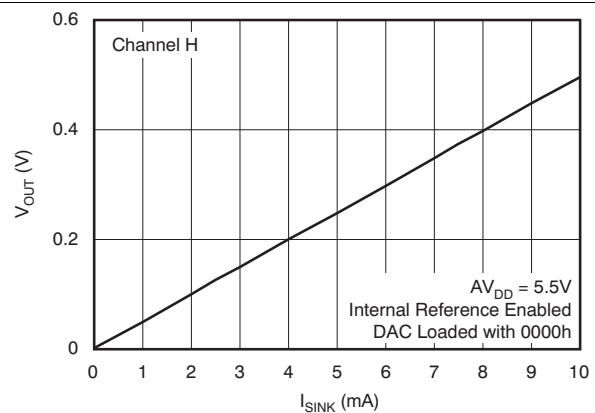

Figure 37. Sink Current at Negative Rail (All Grades)

Typical Characteristics: DAC at AV_{DD} = 5.5 V (continued)

Channel-specific information provided as examples. At T_A = +25°C, external reference used, DAC output not loaded, and all DAC codes in straight binary data format, unless otherwise noted.

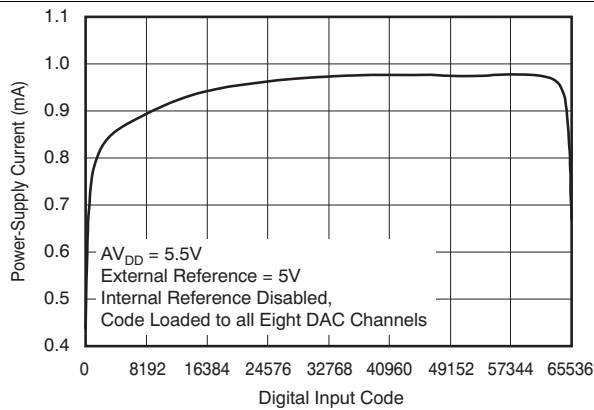

Figure 38. Power-Supply Current vs Digital Input Code

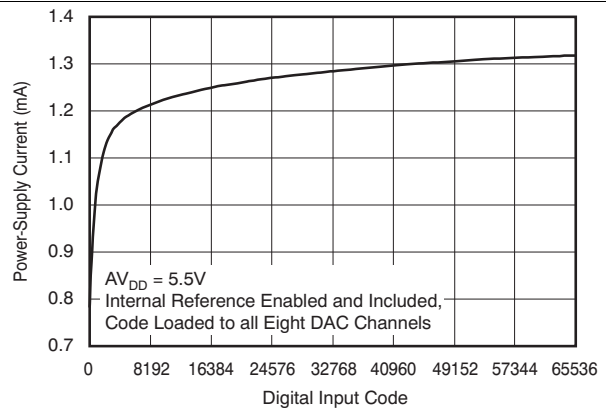

Figure 39. Power-Supply Current vs Digital Input Code

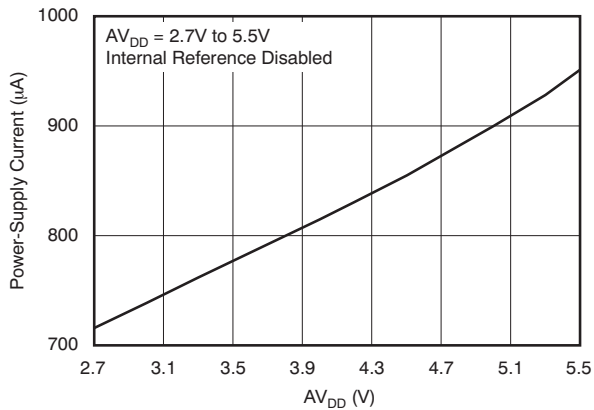

Figure 40. Power-Supply Current vs Power-Supply Voltage

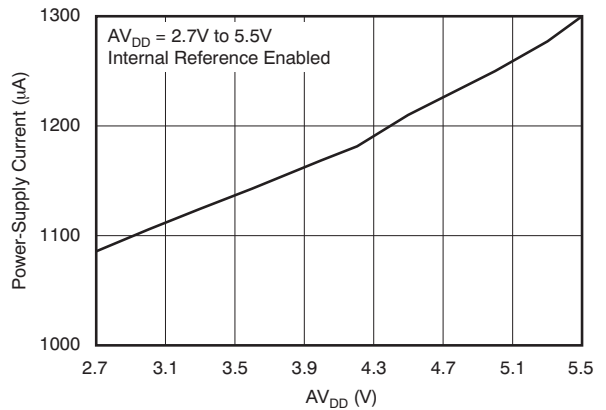

Figure 41. Power-Supply Current vs Power-Supply Voltage

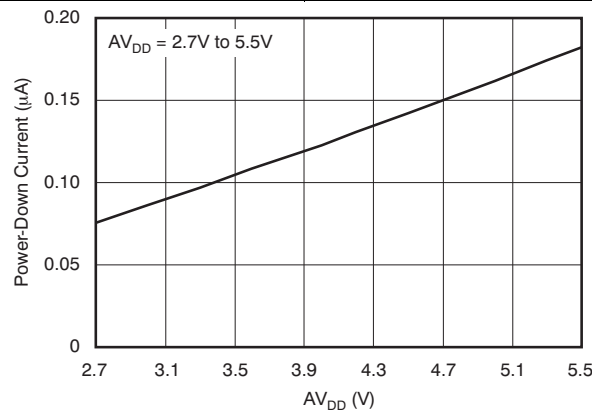

Figure 42. Power-Down Current vs Power-Supply Voltage

Typical Characteristics: DAC at $V_{DD} = 5.5\text{ V}$ (continued)

Channel-specific information provided as examples. At $T_A = +25^\circ\text{C}$, external reference used, DAC output not loaded, and all DAC codes in straight binary data format, unless otherwise noted.

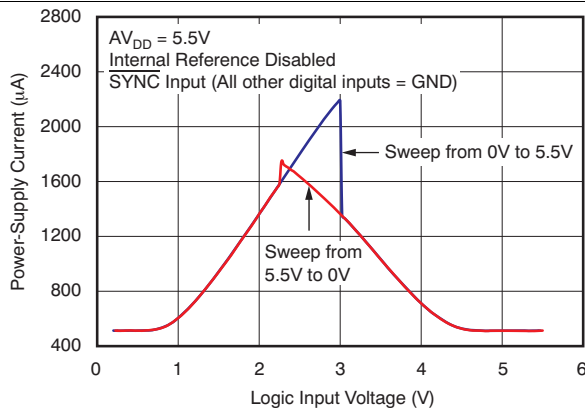

Figure 43. Power-Supply Current vs Logic Input Voltage

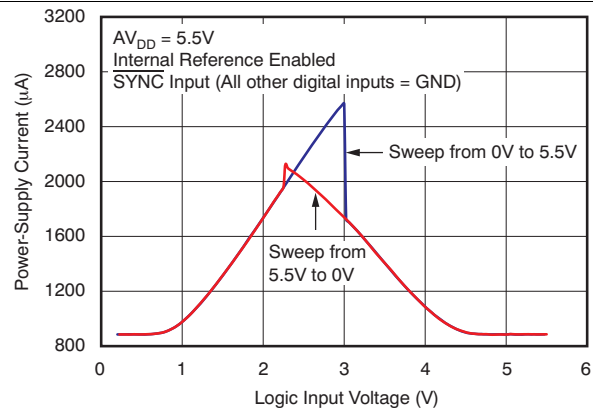

Figure 44. Power-Supply Current vs Logic Input Voltage

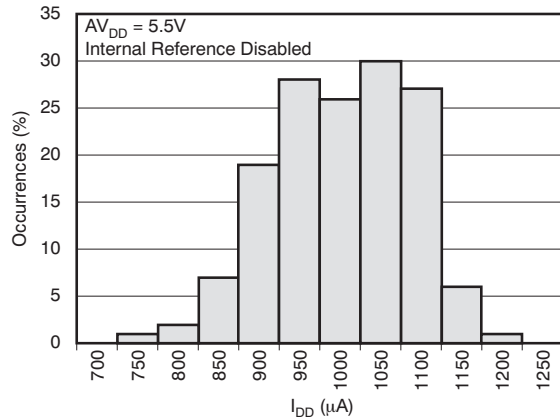

Figure 45. Power-Supply Current Histogram

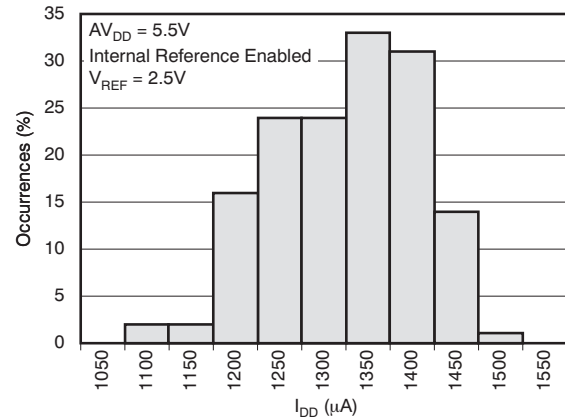

Figure 46. Power-Supply Current Histogram

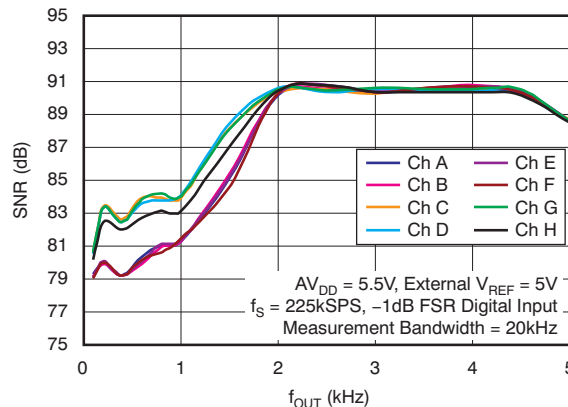

Figure 47. Signal-to-Noise Ratio vs Output Frequency

Typical Characteristics: DAC at $AV_{DD} = 5.5\text{ V}$ (continued)

Channel-specific information provided as examples. At $T_A = +25^\circ\text{C}$, external reference used, DAC output not loaded, and all DAC codes in straight binary data format, unless otherwise noted.

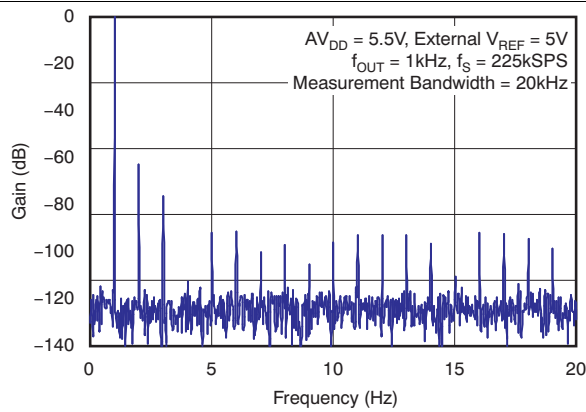

Figure 48. Power Spectral Density

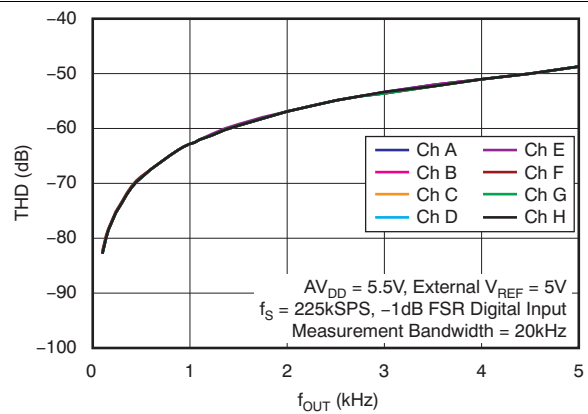

Figure 49. Second Harmonic Distortion vs Output Frequency

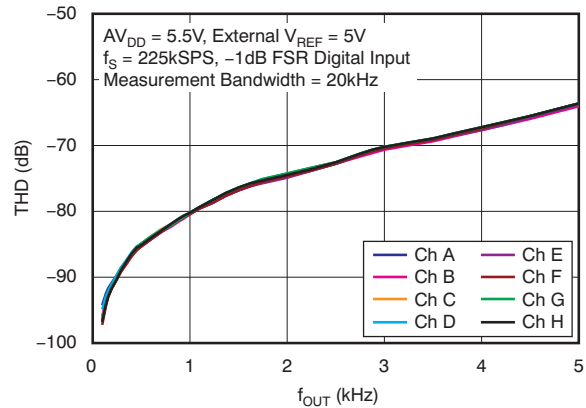

Figure 50. Third Harmonic Distortion vs Output Frequency

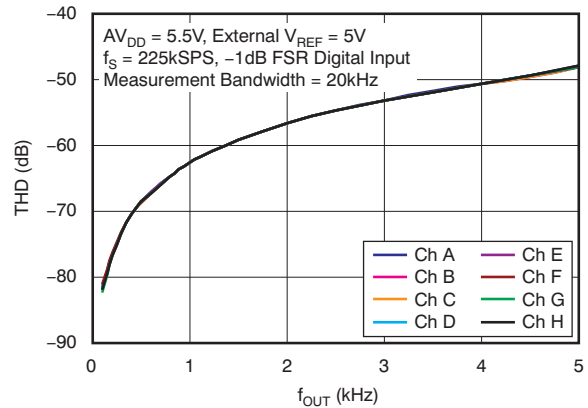

Figure 51. Total Harmonic Distortion vs Output Frequency

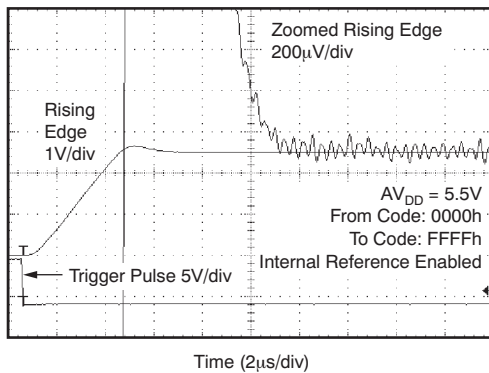

Figure 52. Full-Scale Settling Time: 5-V Rising Edge

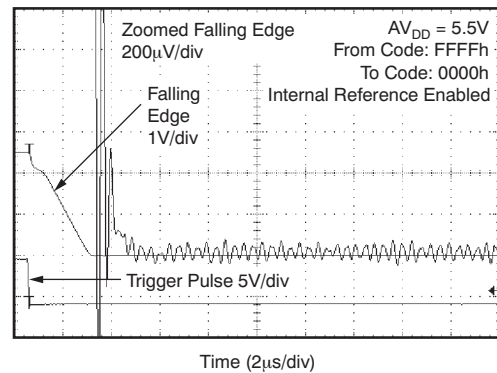

Figure 53. Full-Scale Settling Time: 5-V Falling Edge

Typical Characteristics: DAC at $V_{DD} = 5.5\text{ V}$ (continued)

Channel-specific information provided as examples. At $T_A = +25^\circ\text{C}$, external reference used, DAC output not loaded, and all DAC codes in straight binary data format, unless otherwise noted.

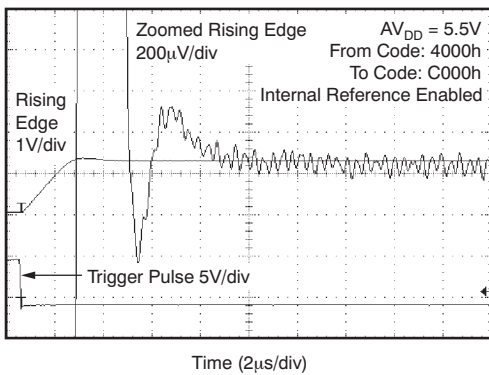

Figure 54. Half-Scale Settling Time: 5-V Rising Edge

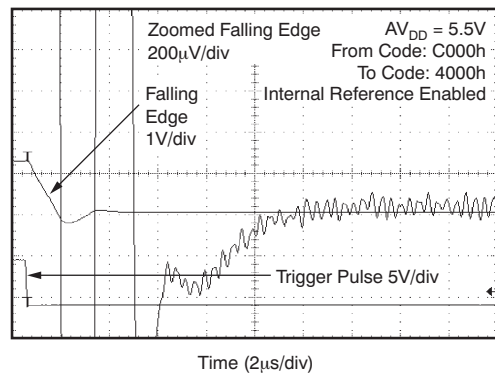

Figure 55. Half-Scale Settling Time: 5-V Falling Edge

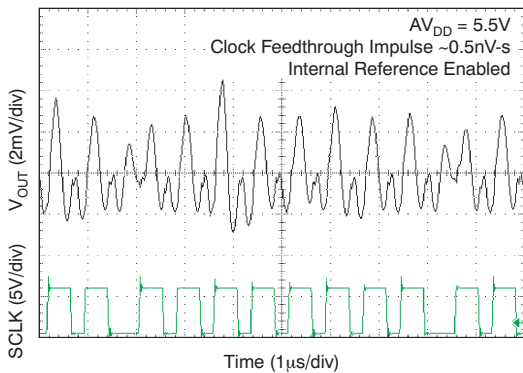

Figure 56. Clock Feedthrough 2 Mhz, Midscale

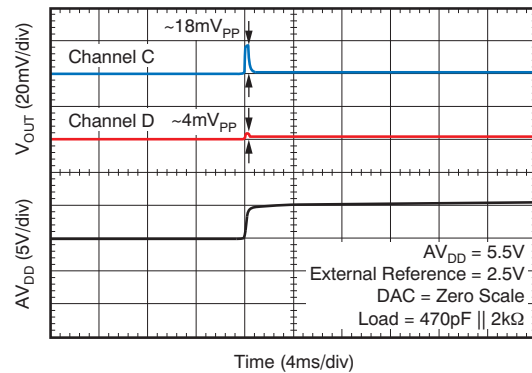

Figure 57. Power-On Glitch Reset to Zero Scale

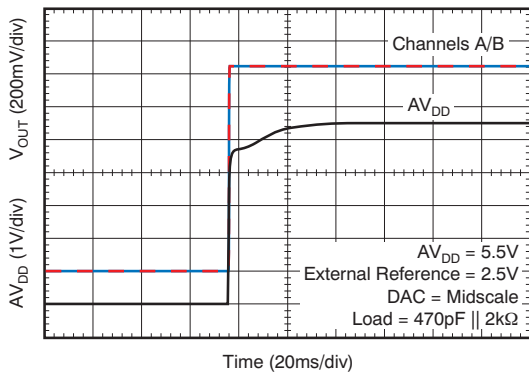

Figure 58. Power-On Glitch Reset To Midscale

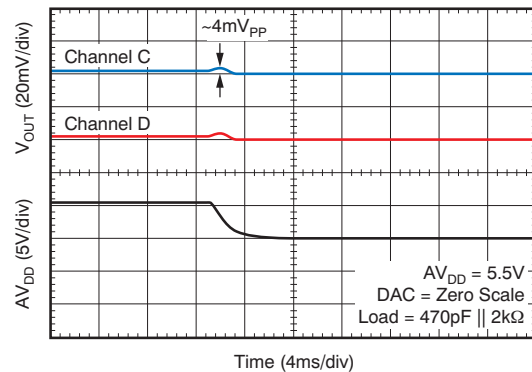

Figure 59. Power-Off Glitch

Typical Characteristics: DAC at $AV_{DD} = 5.5\text{ V}$ (continued)

Channel-specific information provided as examples. At $T_A = +25^\circ\text{C}$, external reference used, DAC output not loaded, and all DAC codes in straight binary data format, unless otherwise noted.

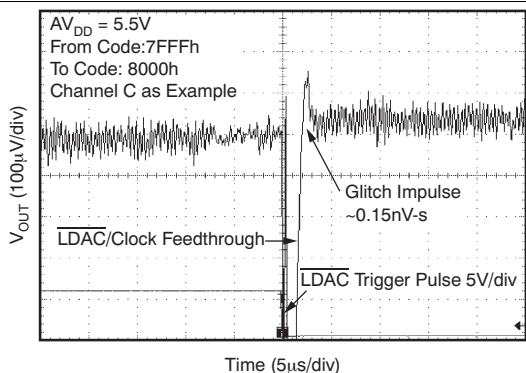

Figure 60. Glitch Energy: 5 V, 1-LSB Step, Rising Edge

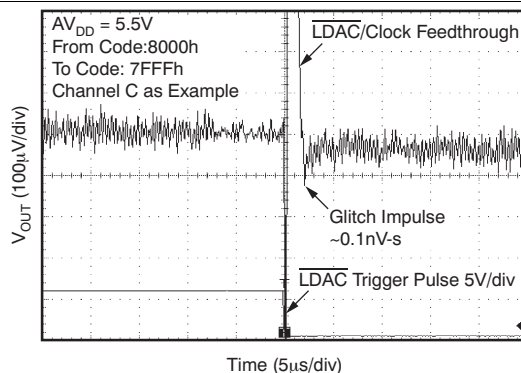

Figure 61. Glitch Energy: 5 V, 1-LSB Step, Falling Edge

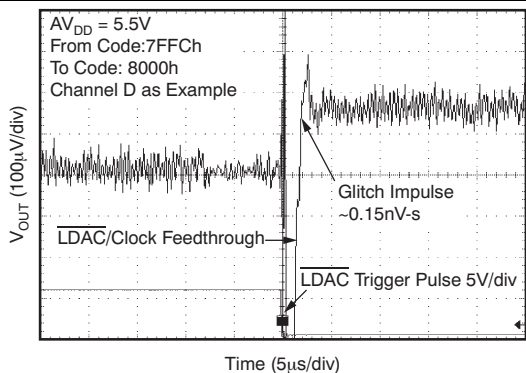

Figure 62. Glitch Energy: 5 V, 4-LSB Step, Rising Edge

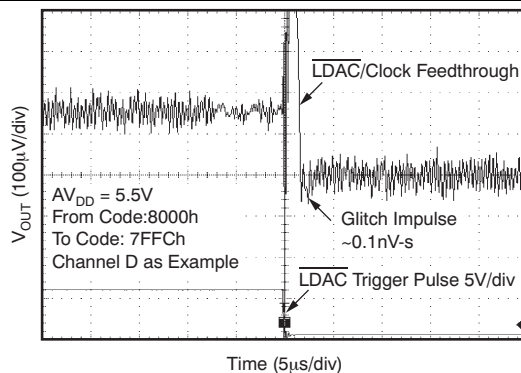

Figure 63. Glitch Energy: 5 V, 4-LSB Step, Falling Edge

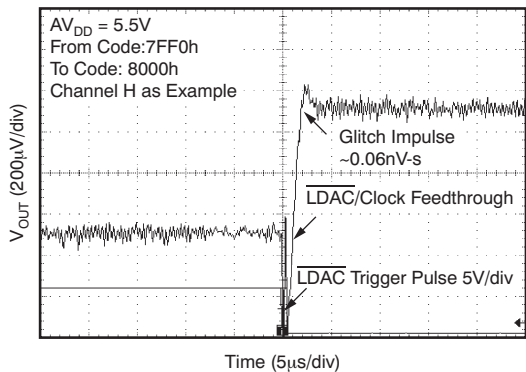

Figure 64. Glitch Energy: 5 V, 16-LSB Step, Rising Edge

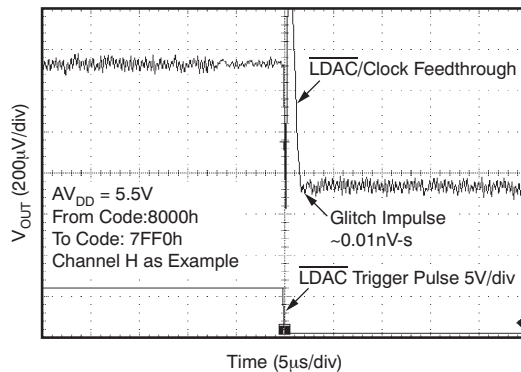
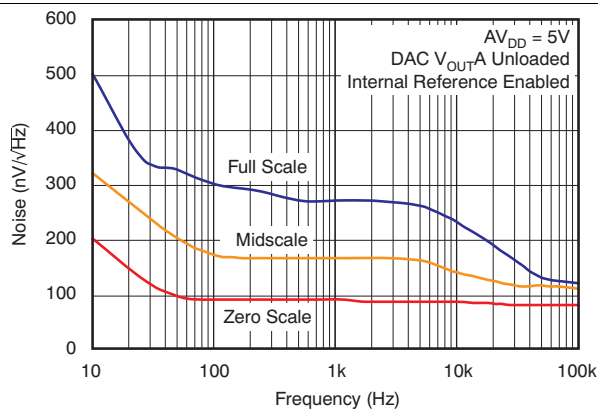

Figure 65. Glitch Energy: 5 V, 16-LSB Step, Falling Edge

Typical Characteristics: DAC at $V_{DD} = 5.5\text{ V}$ (continued)

Channel-specific information provided as examples. At $T_A = +25^\circ\text{C}$, external reference used, DAC output not loaded, and all DAC codes in straight binary data format, unless otherwise noted.



See the [Application Information](#) section of this data sheet for more details.

Figure 66. DAC Output Noise Density vs Frequency

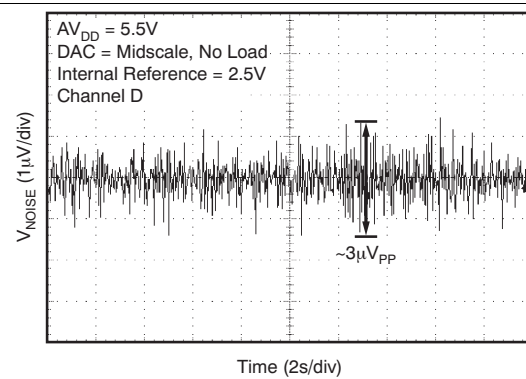

Figure 67. DAC Output Noise 0.1 Hz to 10 Hz

7.6 Typical Characteristics: DAC at AV_{DD} = 3.6 V

Channel-specific information provided as examples. At T_A = +25°C, internal reference used, and DAC output not loaded, all DAC codes in straight binary data format, unless otherwise noted

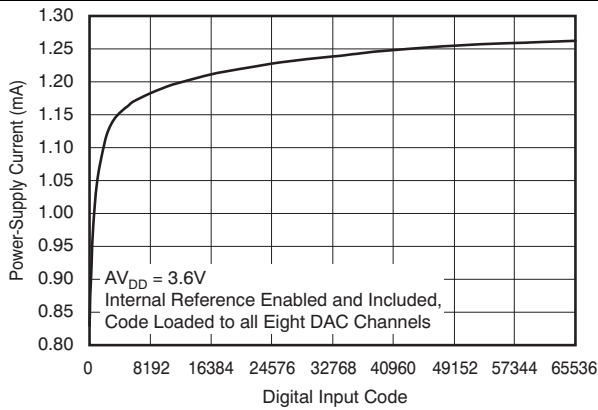

Figure 68. Power-Supply Current vs Digital Input Code

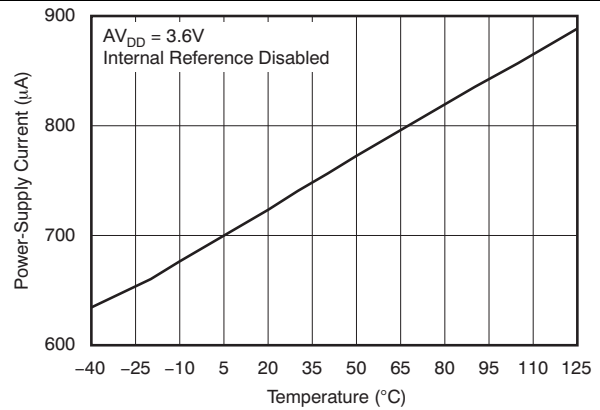

Figure 69. Power-Supply Current vs Temperature

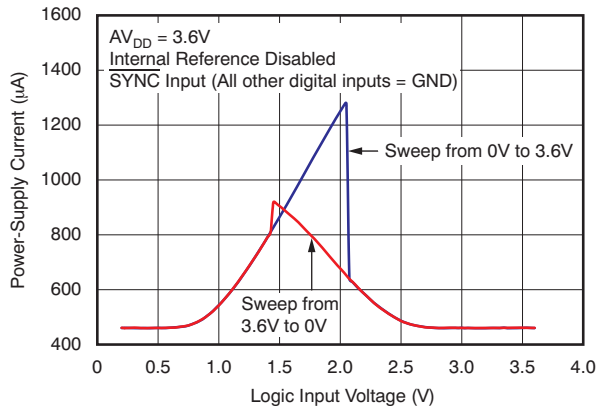

Figure 70. Power-Supply Current vs Logic Input Voltage

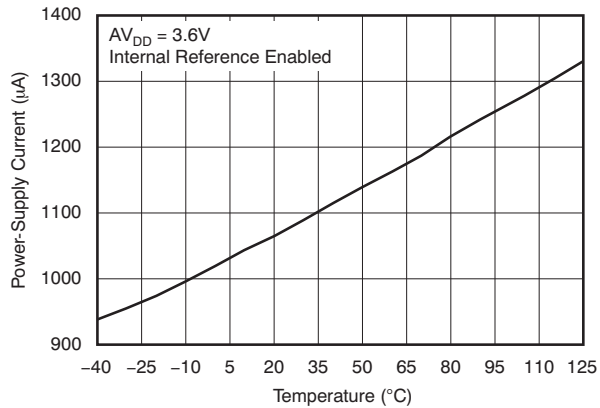

Figure 71. Power-Supply Current vs Temperature

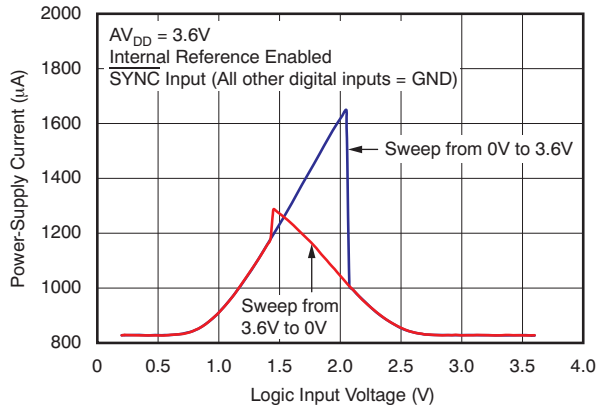

Figure 72. Power-Supply Current vs Logic Input Voltage

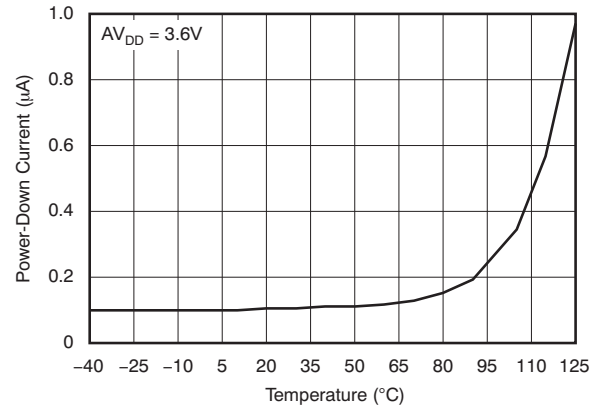
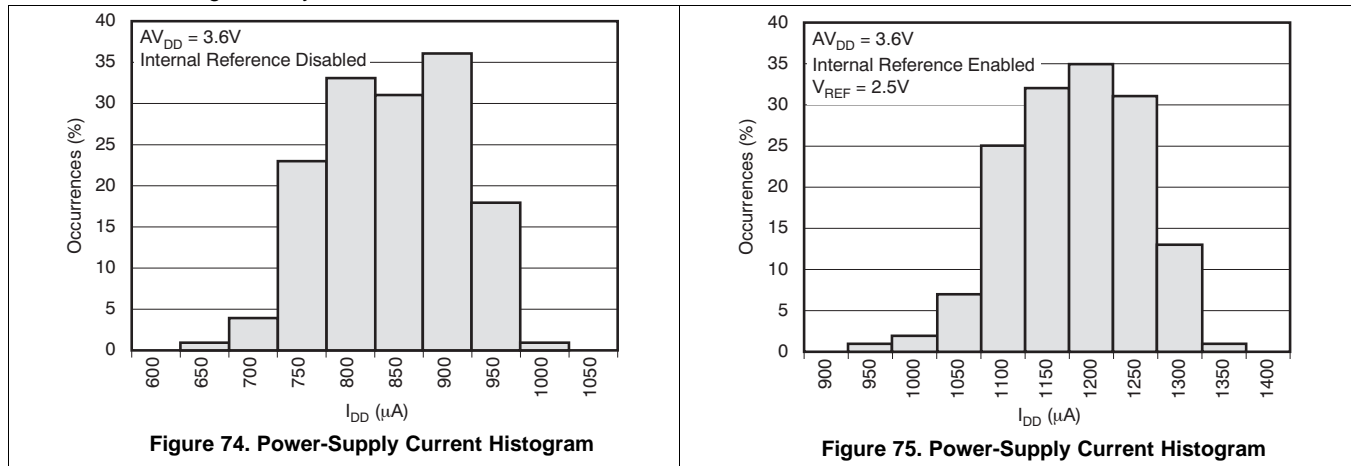

Figure 73. Power-Down Current vs Temperature

Typical Characteristics: DAC at $V_{DD} = 3.6\text{ V}$ (continued)

Channel-specific information provided as examples. At $T_A = +25^\circ\text{C}$, internal reference used, and DAC output not loaded, all DAC codes in straight binary data format, unless otherwise noted



7.7 Typical Characteristics: DAC at $V_{DD} = 2.7\text{ V}$

Channel-specific information provided as examples. At $T_A = +25^\circ\text{C}$, internal reference used, and DAC output not loaded, all DAC codes in straight binary data format, unless otherwise noted

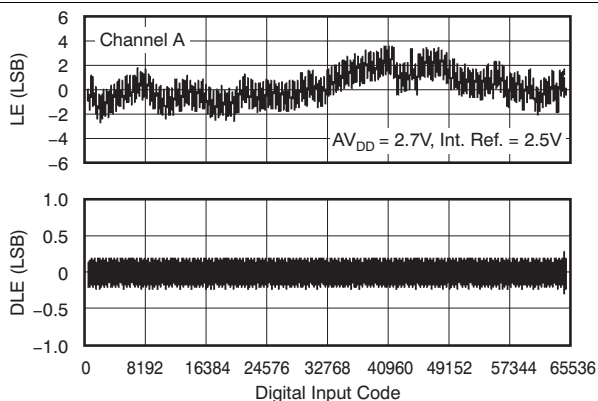

Figure 76. Linearity Error and Differential Linearity Error vs Digital Input Code (-40°C)

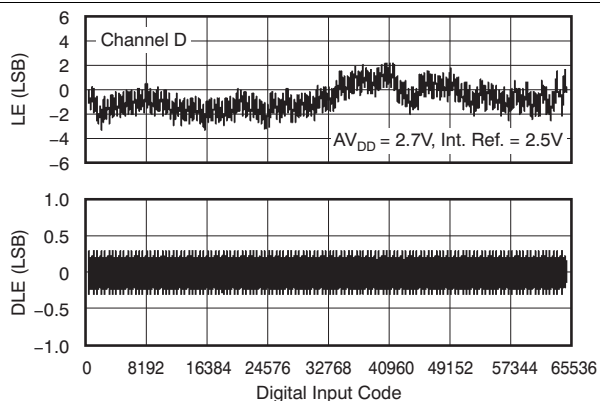

Figure 77. Linearity Error and Differential Linearity Error vs Digital Input Code (-40°C)

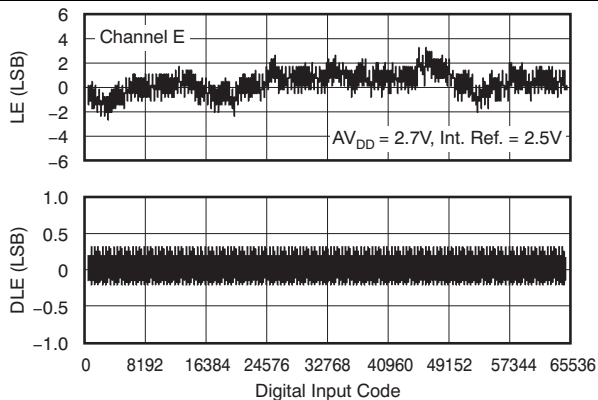

Figure 78. Linearity Error and Differential Linearity Error vs Digital Input Code (-40°C)

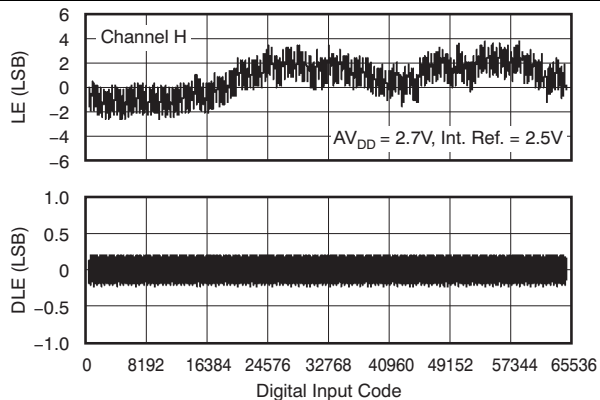

Figure 79. Linearity Error and Differential Linearity Error vs Digital Input Code (-40°C)

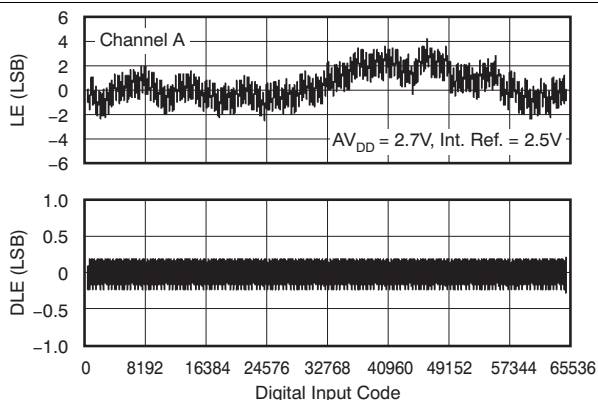

Figure 80. Linearity Error and Differential Linearity Error vs Digital Input Code ($+25^\circ\text{C}$)

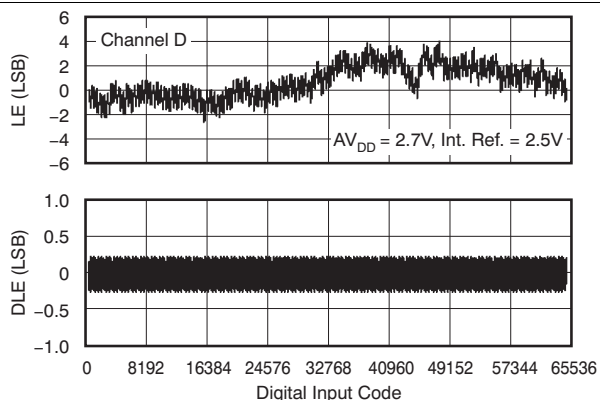

Figure 81. Linearity Error and Differential Linearity Error vs Digital Input Code ($+25^\circ\text{C}$)

Typical Characteristics: DAC at $V_{DD} = 2.7\text{ V}$ (continued)

Channel-specific information provided as examples. At $T_A = +25^\circ\text{C}$, internal reference used, and DAC output not loaded, all DAC codes in straight binary data format, unless otherwise noted

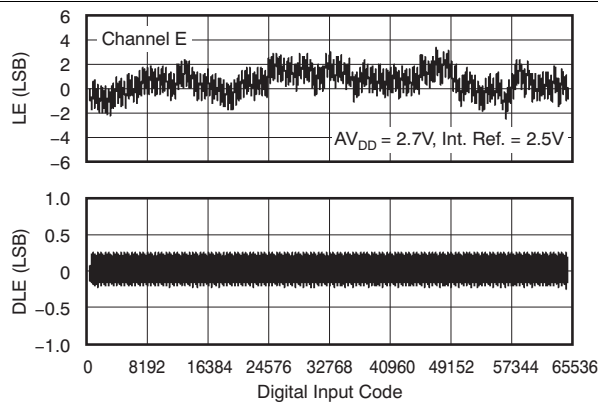

Figure 82. Linearity Error and Differential Linearity Error vs Digital Input Code (+25°C)

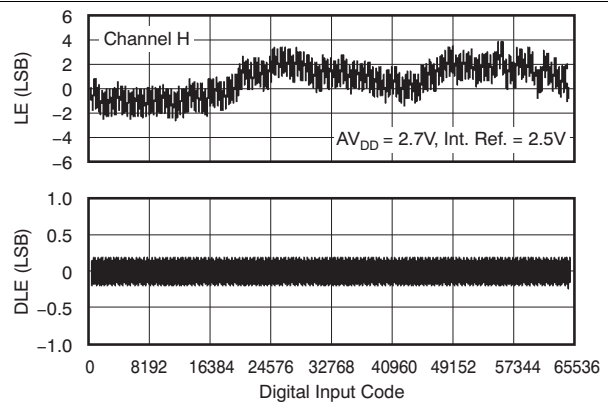

Figure 83. Linearity Error and Differential Linearity Error vs Digital Input Code (+25°C)

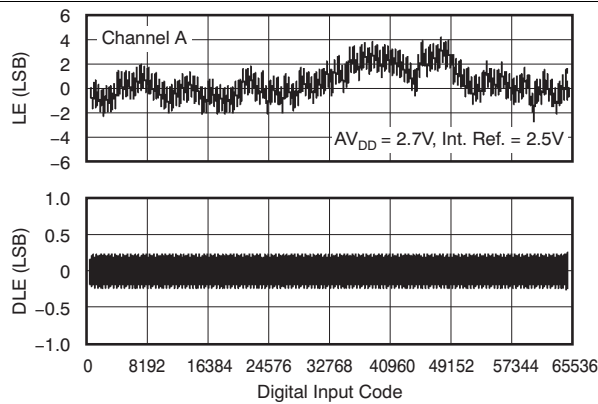

Figure 84. Linearity Error and Differential Linearity Error vs Digital Input Code (+105°C)

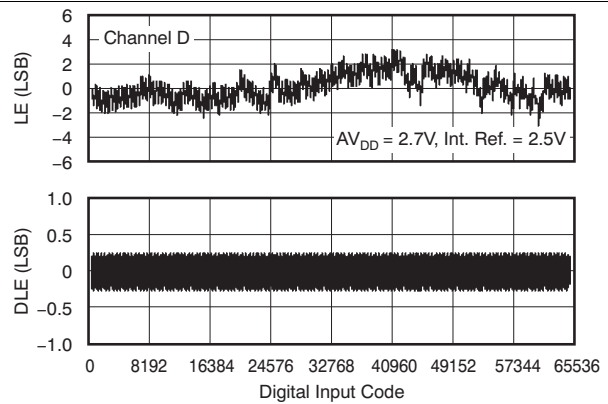

Figure 85. Linearity Error and Differential Linearity Error vs Digital Input Code (+105°C)

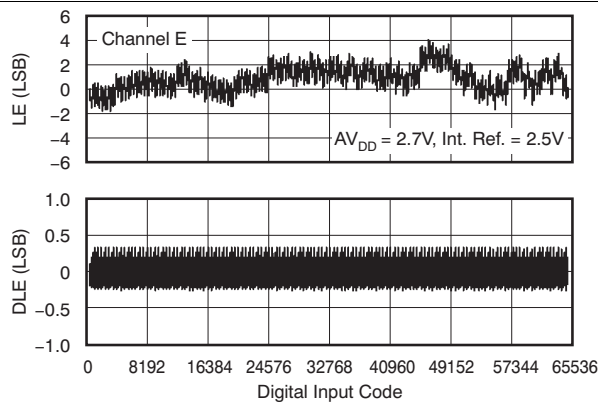

Figure 86. Linearity Error and Differential Linearity Error vs Digital Input Code (+105°C)

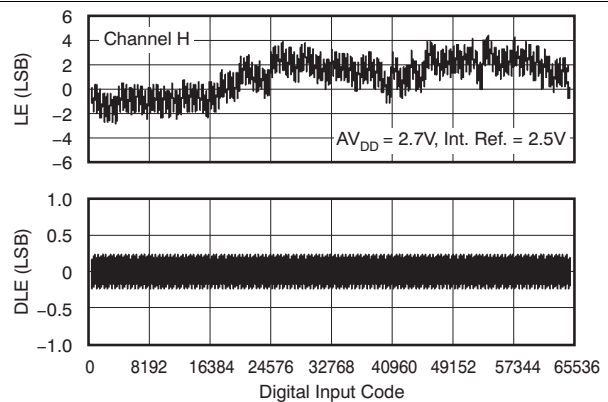

Figure 87. Linearity Error and Differential Linearity Error vs Digital Input Code (+105°C)

Typical Characteristics: DAC at AV_{DD} = 2.7 V (continued)

Channel-specific information provided as examples. At T_A = +25°C, internal reference used, and DAC output not loaded, all DAC codes in straight binary data format, unless otherwise noted

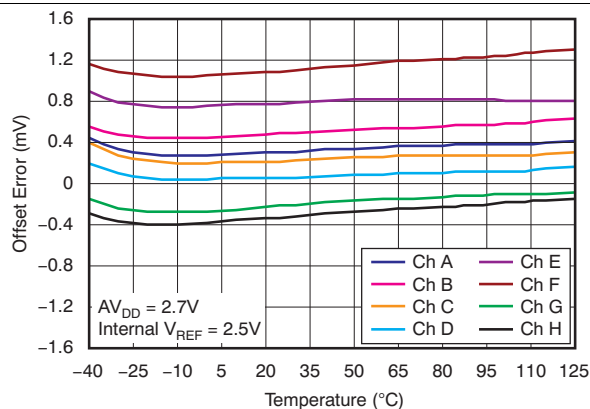

Figure 88. Offset Error vs Temperature

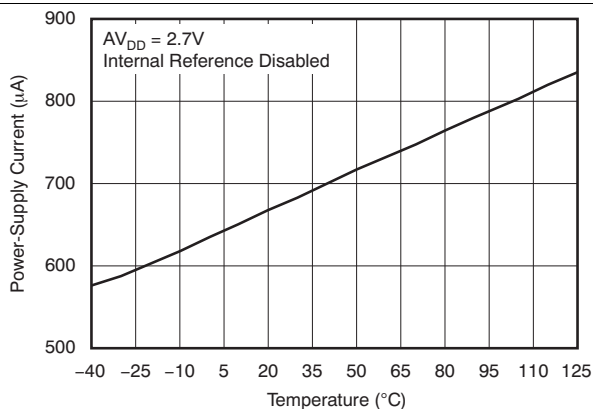

Figure 89. Power-Supply Current vs Temperature

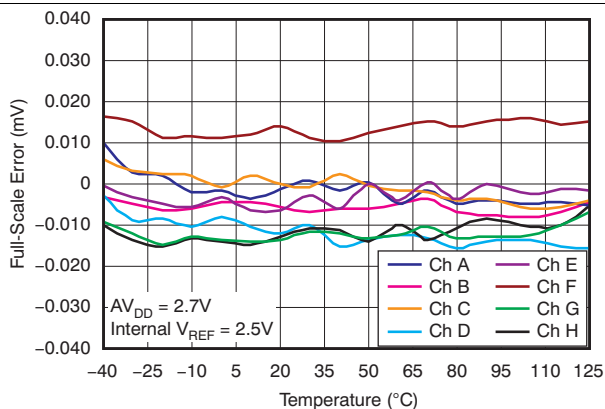

Figure 90. Full-Scale Error vs Temperature

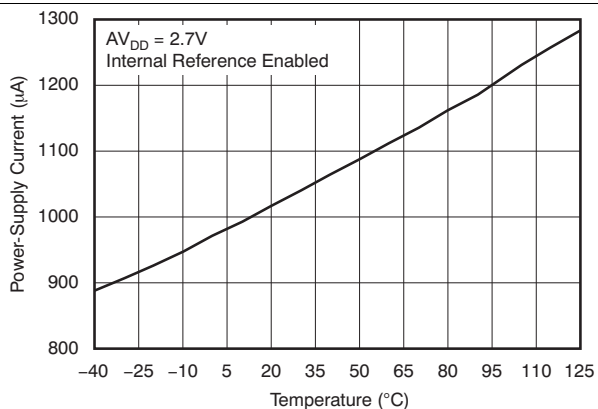

Figure 91. Power-Supply Current vs Temperature

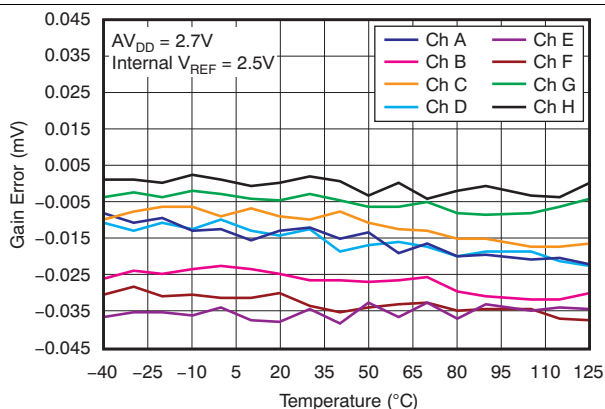

Figure 92. Gain Error vs Temperature

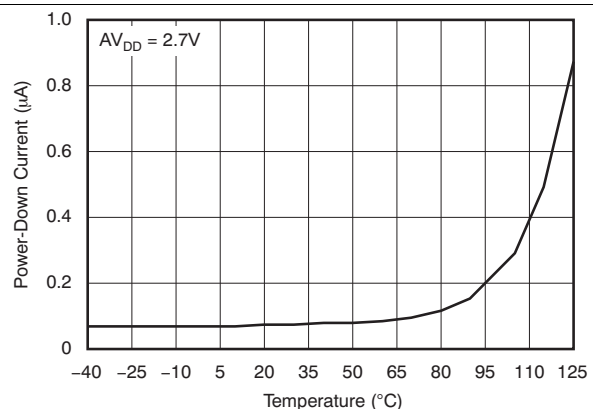

Figure 93. Power-Down Current vs Temperature

Typical Characteristics: DAC at $V_{DD} = 2.7\text{ V}$ (continued)

Channel-specific information provided as examples. At $T_A = +25^\circ\text{C}$, internal reference used, and DAC output not loaded, all DAC codes in straight binary data format, unless otherwise noted

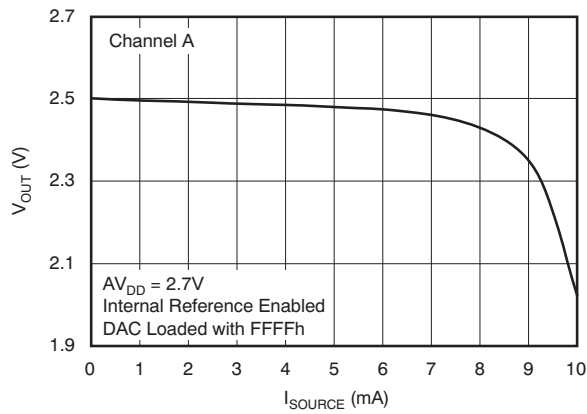

Figure 94. Source Current at Positive Rail (Grades A and B)

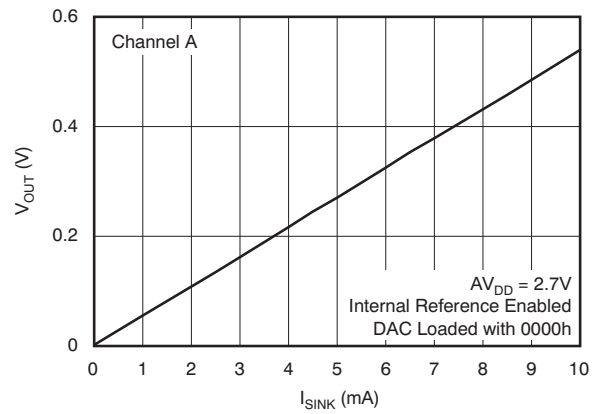

Figure 95. Sink Current at Negative Rail (All Grades)

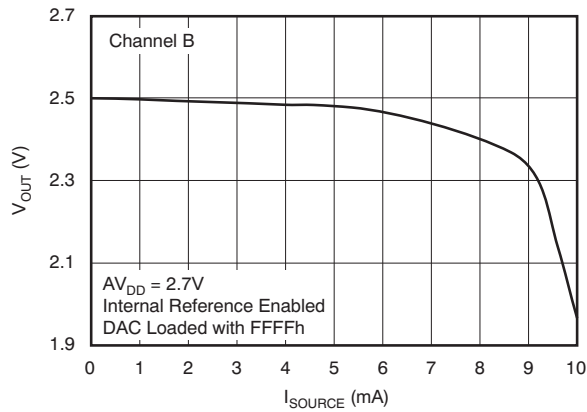

Figure 96. Source Current at Positive Rail (Grades A and B)

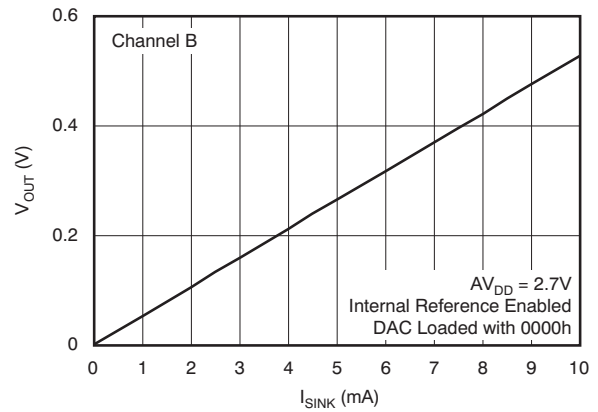

Figure 97. Sink Current at Negative Rail (All Grades)

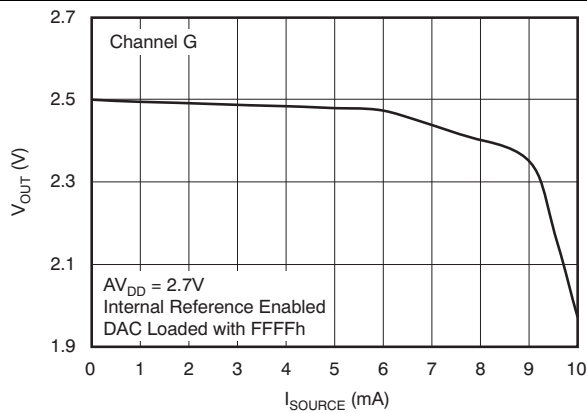

Figure 98. Source Current at Positive Rail (Grades A and B)

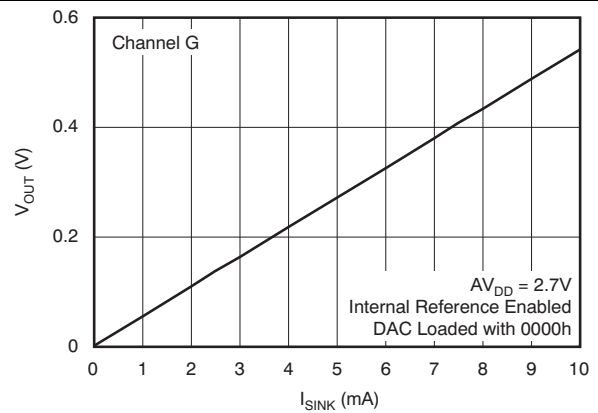

Figure 99. Sink Current at Negative Rail (All Grades)

Typical Characteristics: DAC at AV_{DD} = 2.7 V (continued)

Channel-specific information provided as examples. At T_A = +25°C, internal reference used, and DAC output not loaded, all DAC codes in straight binary data format, unless otherwise noted

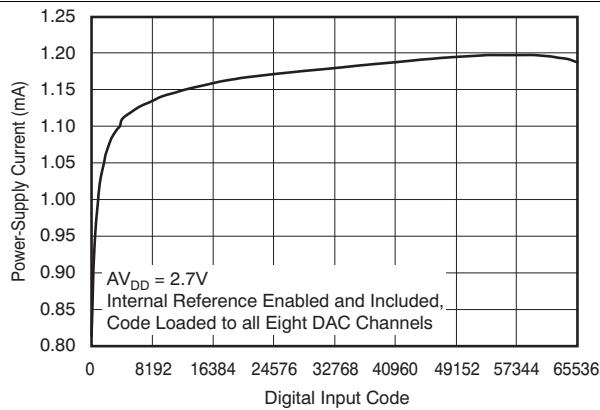

Figure 100. Power-Supply Current Vs Digital Input Code

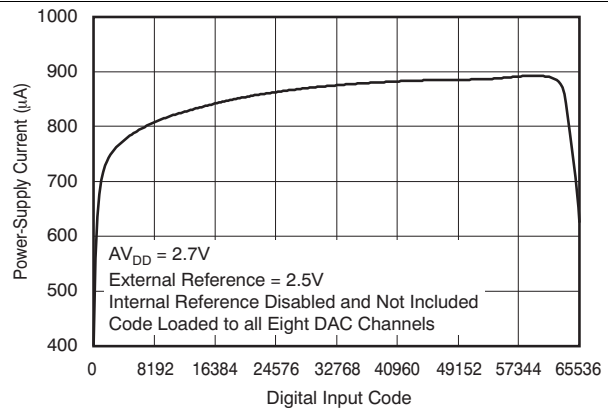

Figure 101. Power-Supply Current vs Digital Input Code

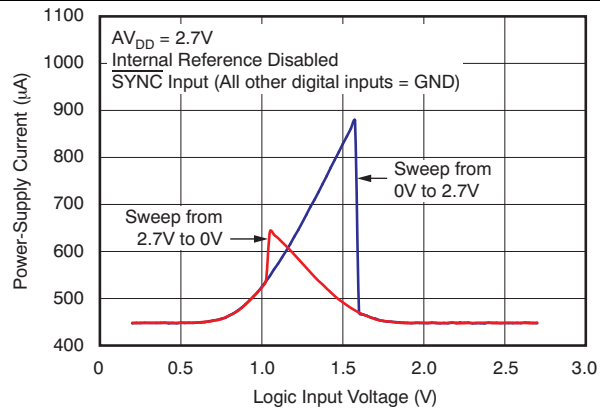

Figure 102. Power-Supply Current vs Logic Input Voltage

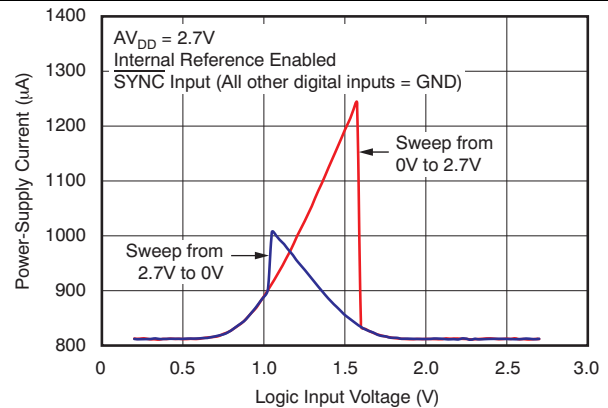

Figure 103. Power-Supply Current vs Logic Input Voltage

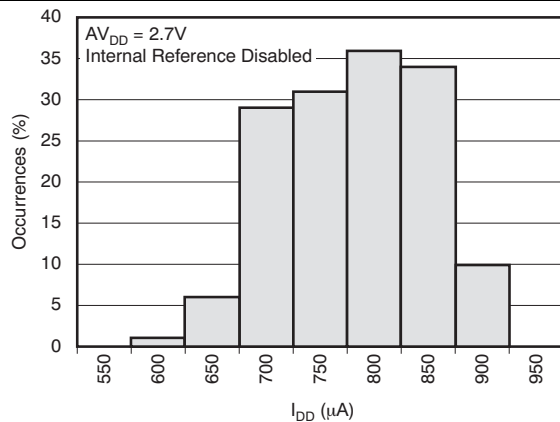

Figure 104. Power-Supply Current Histogram

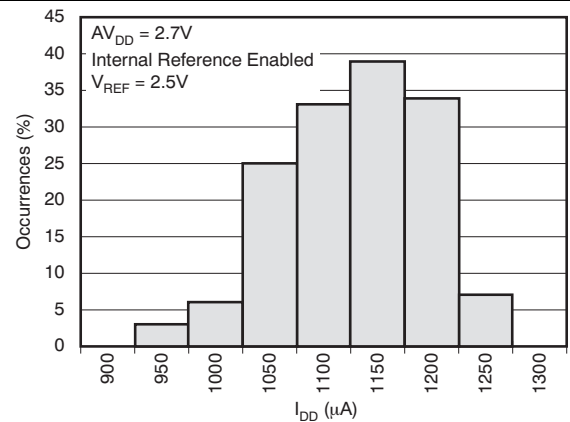

Figure 105. Power-Supply Current Histogram

Typical Characteristics: DAC at $V_{DD} = 2.7\text{ V}$ (continued)

Channel-specific information provided as examples. At $T_A = +25^\circ\text{C}$, internal reference used, and DAC output not loaded, all DAC codes in straight binary data format, unless otherwise noted

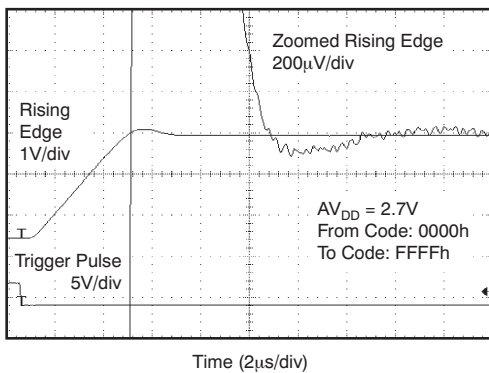

Figure 106. Full-Scale Settling Time: 2.7-V Rising Edge

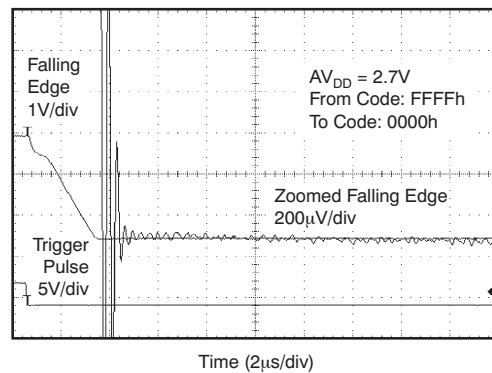

Figure 107. Full-Scale Settling Time: 2.7-V Falling Edge

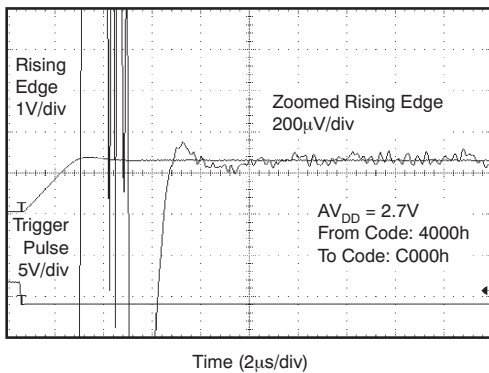

Figure 108. Half-Scale Settling Time: 2.7-V Rising Edge

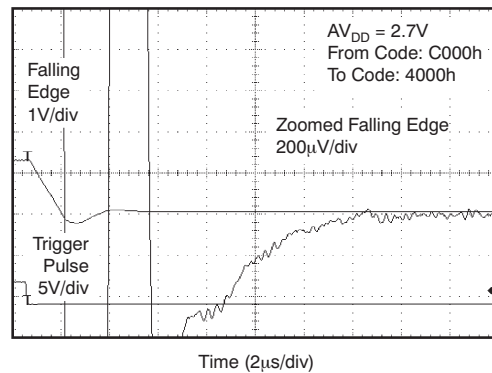

Figure 109. Half-Scale Settling Time: 2.7-V Falling Edge

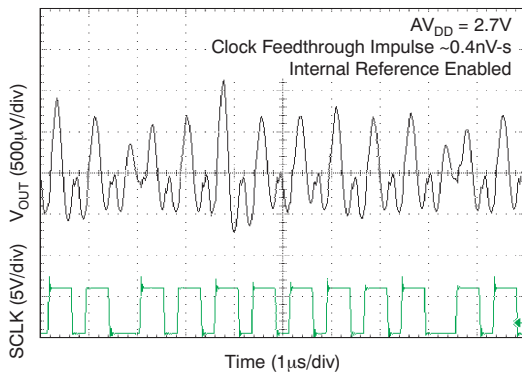

Figure 110. Clock Feedthrough 2.7 V, 2 Mhz, Midscale

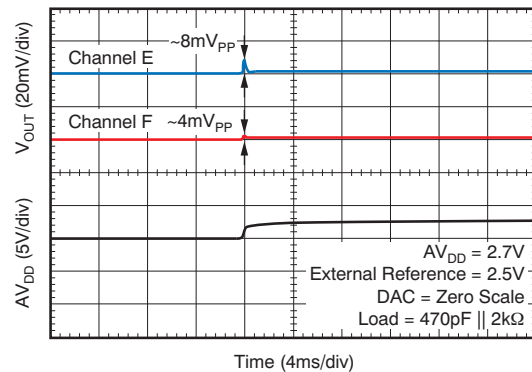

Figure 111. Power-On Glitch Reset to Zero Scale

Typical Characteristics: DAC at $AV_{DD} = 2.7\text{ V}$ (continued)

Channel-specific information provided as examples. At $T_A = +25^\circ\text{C}$, internal reference used, and DAC output not loaded, all DAC codes in straight binary data format, unless otherwise noted

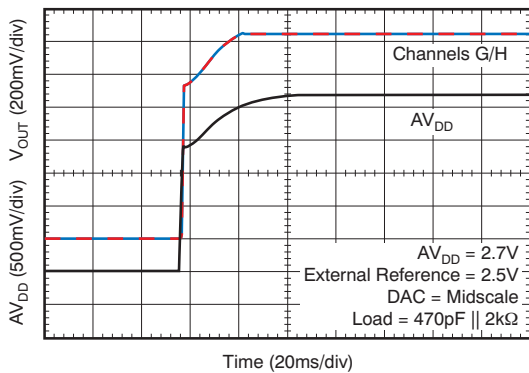

Figure 112. Power-On Glitch Reset to Midscale

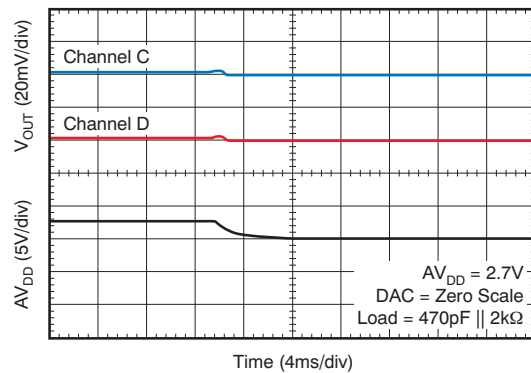

Figure 113. Power-Off Glitch

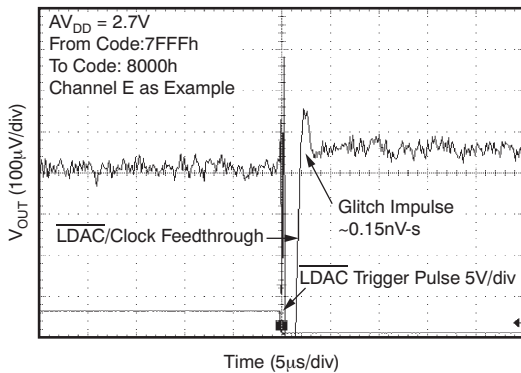

Figure 114. Glitch Energy: 2.7 V, 1-LSB Step, Rising Edge

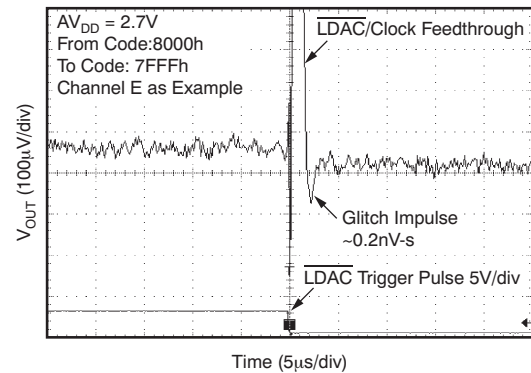

Figure 115. Glitch Energy: 2.7 V, 1-LSB Step, Falling Edge

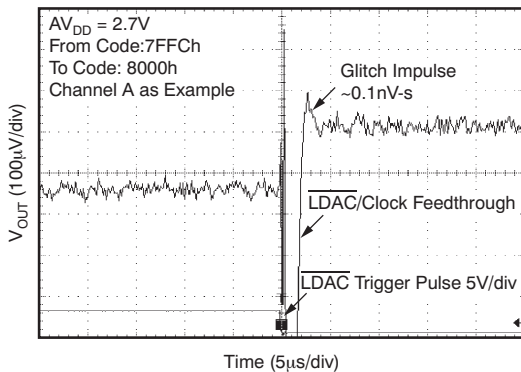

Figure 116. Glitch Energy: 2.7 V, 4-LSB Step, Rising Edge

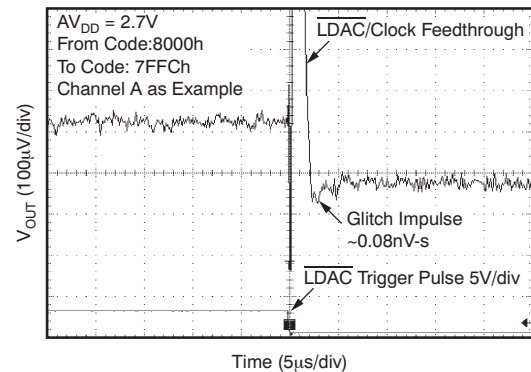
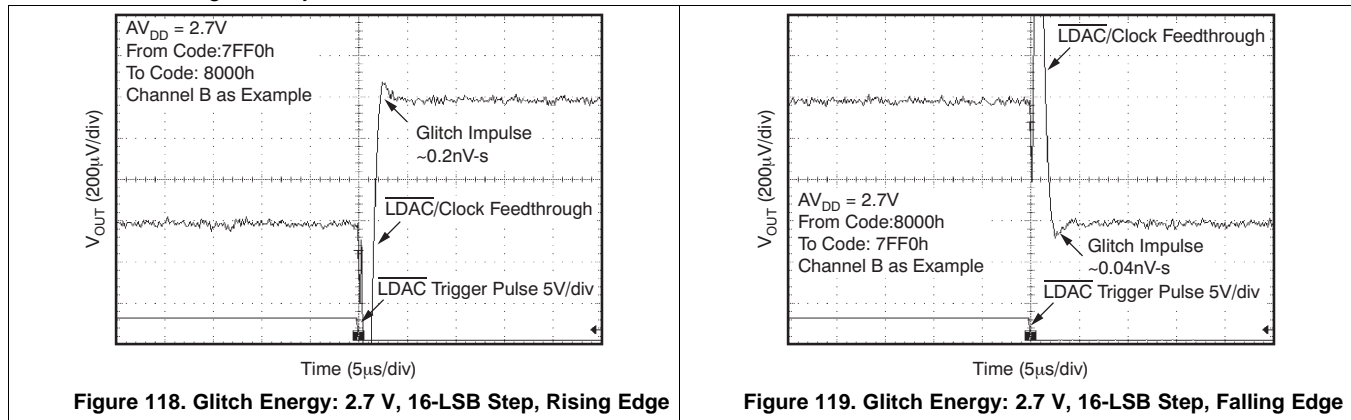

Figure 117. Glitch Energy: 2.7 V, 4-LSB Step, Falling Edge

Typical Characteristics: DAC at $AV_{DD} = 2.7\text{ V}$ (continued)

Channel-specific information provided as examples. At $T_A = +25^\circ\text{C}$, internal reference used, and DAC output not loaded, all DAC codes in straight binary data format, unless otherwise noted



8 Detailed Description

8.1 Functional Block Diagram

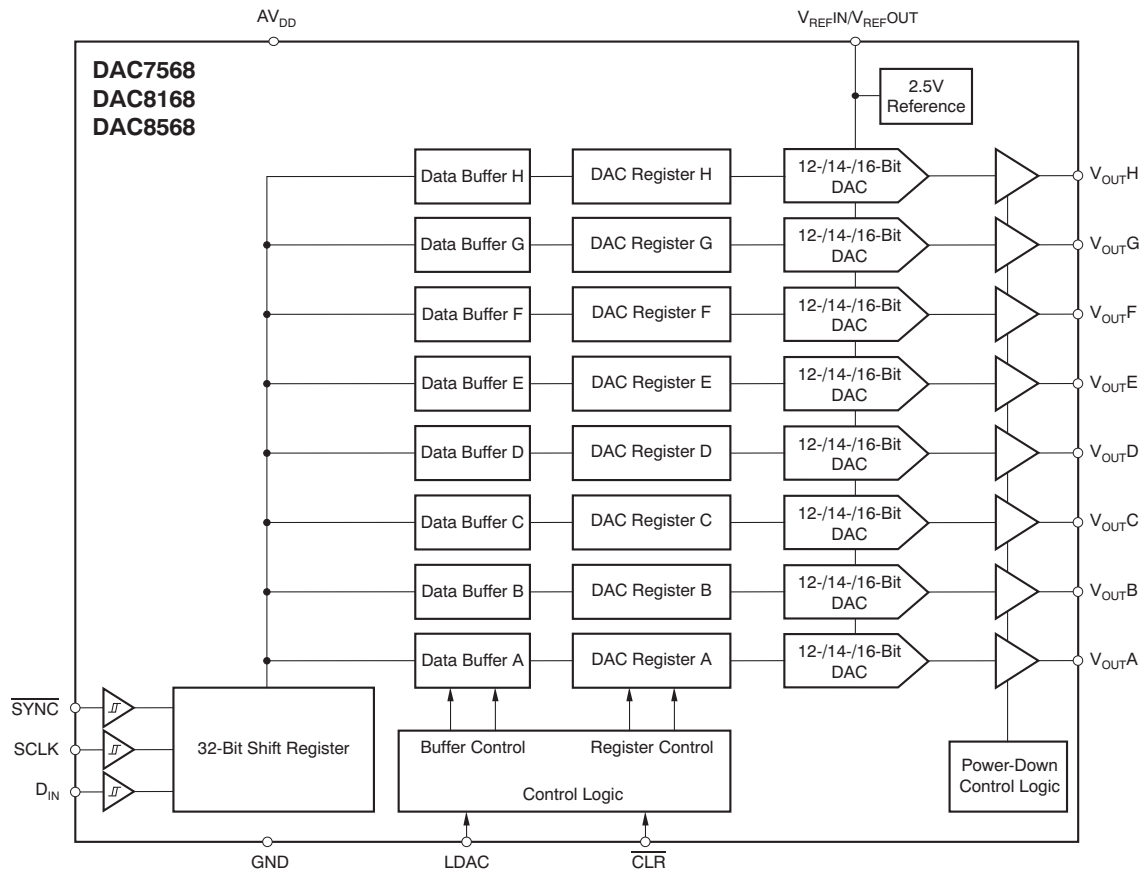

8.2 Feature Description

8.2.1 Digital-to-Analog Converter (DAC)

The DAC7568, DAC8168, and DAC8568 architecture consists of eight string DACs each followed by an output buffer amplifier. The devices include an internal 2.5V reference with 2ppm/°C temperature drift performance, and offer either 5V or 2.5V full scale output voltage. Figure 120 shows a principal block diagram of the DAC architecture.

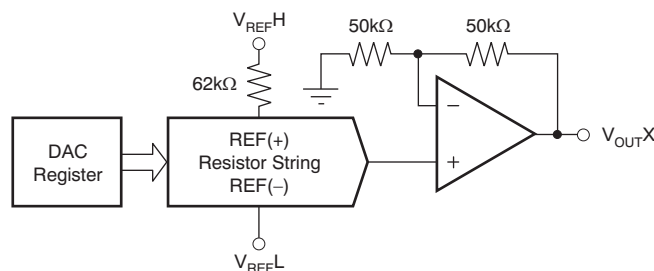

Figure 120. Device Architecture

The input coding to the DAC7568, DAC8168, and DAC8568 is straight binary, so the ideal output voltage is given by Equation 1:

Feature Description (continued)

$$V_{OUT} = \left[\frac{D_{IN}}{2^n} \right] \times V_{REF} \times \text{Gain} \quad (1)$$

Where:

D_{IN} = decimal equivalent of the binary code that is loaded to the DAC register. It can range from 0 to 4095 for DAC7568 (12 bit), 0 to 16,383 for DAC8168 (14 bit), and 0 to 65535 for DAC8568 (16 bit).

n = resolution in bits; either 12 (DAC7568), 14 (DAC8168) or 16 (DAC8568)

Gain = 1 for A/B grades or 2 for C/D grades.

8.2.2 Resistor String

The resistor string section is shown in [Figure 121](#). It is simply a string of resistors, each of value R . The code loaded into the DAC register determines at which node on the string the voltage is tapped off to be fed into the output amplifier by closing one of the switches connecting the string to the amplifier. It is monotonic because it is a string of resistors.

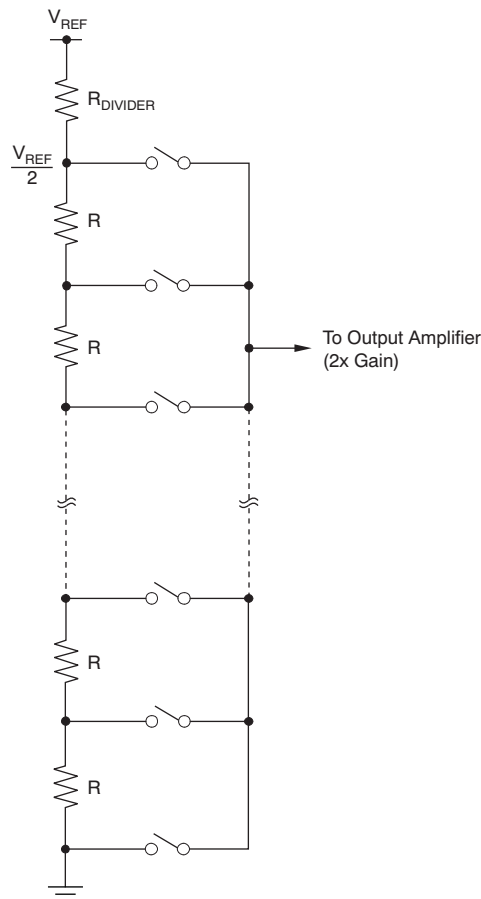

Figure 121. Resistor String

8.2.3 Output Amplifier

The output buffer amplifier is capable of generating rail-to-rail voltages on its output, giving a maximum output range of 0V to AV_{DD} . It is capable of driving a load of $2k\Omega$ in parallel with $3000pF$ to GND. The source and sink capabilities of the output amplifier can be seen in the [Typical Characteristics](#). The typical slew rate is $0.75V/\mu s$, with a typical full-scale settling time of $5\mu s$ with the output unloaded.

Feature Description (continued)

8.2.4 Internal Reference

The DAC7568, DAC8168, and DAC8568 include a 2.5V internal reference that is disabled by default. The internal reference is externally available at the V_{REFIN}/V_{REFOUT} pin. A minimum 100nF capacitor is recommended between the reference output and GND for noise filtering.

The internal reference of the DAC7568, DAC8168, and DAC8568 is a bipolar, transistor-based, precision bandgap voltage reference. Figure 122 shows the basic bandgap topology. Transistors Q_1 and Q_2 are biased such that the current density of Q_1 is greater than that of Q_2 . The difference of the two base-emitter voltages ($V_{BE1} - V_{BE2}$) has a positive temperature coefficient and is forced across resistor R_1 . This voltage is gained up and added to the base-emitter voltage of Q_2 , which has a negative temperature coefficient. The resulting output voltage is virtually independent of temperature. The short-circuit current is limited by design to approximately 100mA.

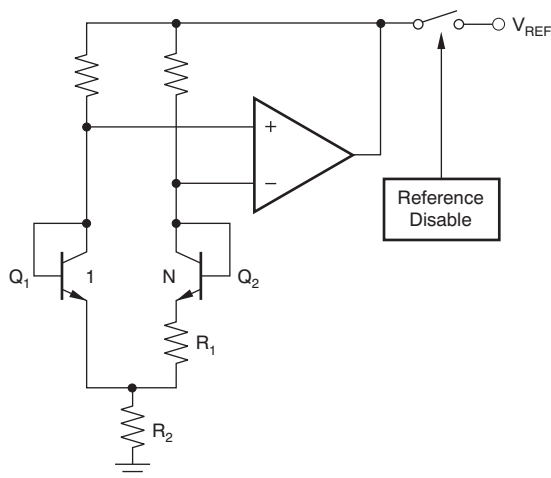

Figure 122. Bandgap Reference Simplified Schematic

Refer to [Enable/Disable Internal Reference](#) section for information on enabling and disabling the internal reference.

8.2.5 Serial Interface

The DAC7568, DAC8168, and DAC8568 have a 3-wire serial interface (\overline{SYNC} , SCLK, and D_{IN} ; see the [Pin Configurations](#)) compatible with SPI, QSPI, and Microwire interface standards, as well as most DSPs. See the Serial Write Operation timing diagram (Figure 1) for an example of a typical write sequence.

The DAC7568, DAC8168, and DAC8568 input shift register is 32-bits wide, consisting of four prefix bits (DB31 to DB28), four control bits (DB27 to DB24), 16 data bits (DB23 to DB4), and four feature bits. The 16 data bits comprise the 16-, 14-, or 12-bit input code. When writing to the DAC register (data transfer), bits DB0 to DB3 (for 16-bit operation), DB0 to DB5 (for 14-bit operation), and DB0 to DB7 (for 12-bit operation) are ignored by the DAC and should be treated as *don't care* bits (see Table 1 to Table 3). All 32 bits of data are loaded into the DAC under the control of the serial clock input, SCLK.

DB31 (MSB) is the first bit that is loaded into the DAC shift register and must be always set to '0'. It is followed by the rest of the 32-bit word pattern, left-aligned. This configuration means that the first 32 bits of data are latched into the shift register and any further clocking of data is ignored. When the DAC registers are being written to, the DAC7568, DAC8168, and DAC8568 receive all 32 bits of data, ignore DB31 to DB28, and decode the second set of four bits (DB27 to DB24) in order to determine the DAC operating/control mode (see). Bits DB23 to DB20 are used to address selected DAC channels. The next 16/14/12 bits of data that follow are decoded by the DAC to determine the equivalent analog output. The last four data bits (DB0 to DB3 for DAC8568), last data six bits (DB0 to DB5 for DAC8168), or last eight data bits (DB0 to DB7 for DAC7568) are ignored in this case. For more details on these and other commands (such as write to LDAC register, power down DACs, etc.), see Table 4.

Feature Description (continued)

The data format is straight binary with all '0's corresponding to 0V output and all '1's corresponding to full-scale output. For all documentation purposes, the data format and representation used here is a true 16-bit pattern (that is, FFFFh for data word for full-scale) that the DAC7568, DAC8168, and DAC8568 require.

The write sequence begins by bringing the $\overline{\text{SYNC}}$ line low. Data from the D_{IN} line are clocked into the 32-bit shift register on each falling edge of SCLK. The serial clock frequency can be as high as 50MHz, making the DAC7568, DAC8168, and DAC8568 compatible with high-speed DSPs. On the 32nd falling edge of the serial clock, the last data bit is clocked into the shift register and the shift register locks. Further clocking does not change the shift register data. After receiving the 32nd falling clock edge, the DAC7568, DAC8168, and DAC8568 decode the four control bits and four address bits and 16/14/12 data bits to perform the required function, without waiting for a $\overline{\text{SYNC}}$ rising edge. A new write sequence starts at the next falling edge of $\overline{\text{SYNC}}$. A rising edge of $\overline{\text{SYNC}}$ before the 31st-bit sequence is complete resets the SPI interface; no data transfer occurs. After the 32nd falling edge of SCLK is received, the $\overline{\text{SYNC}}$ line may be kept low or brought high. In either case, the minimum delay time from the 32nd falling SCLK edge to the next falling $\overline{\text{SYNC}}$ edge must be met in order to properly begin the next cycle; see the Serial Write Operation timing diagram (Figure 1). To assure the lowest power consumption of the device, care should be taken that the levels are as close to each rail as possible. Refer to the 5.5V, 3.6V, and 2.7V Typical Characteristics sections for the *Power-Supply Current vs Logic Input Voltage* graphs (Figure 43, Figure 44, Figure 70, Figure 72, Figure 102, and Figure 103).

Feature Description (continued)

8.2.6 Input Shift Register

The input shift register (SR) of the DAC7568, DAC8168, and DAC8568 is 32 bits wide (as shown in [Table 1](#), [Table 2](#), and [Table 3](#), respectively), and consists of four Prefix bits (DB31 to DB28), four control bits (DB27 to DB24), 16 data bits (DB23 to DB4), and four additional feature bits. The 16 data bits comprise the 16-, 14-, or 12-bit input code.

The DAC7568, DAC8168, and DAC8568 support a number of different load commands. The load commands are summarized in [Table 4](#).

Table 1. DAC8568 Data Input Register Format

| DB31 | | | | DB27 | | | | DB23 | | | | DB19 | | | | DB4 | | | | DB0 | | | | | | | | | | | |
|-------------------|---|---|---|------------------|----|----|----|--------------|----|----|----|-----------------------|-----|-----|-----|-----|-----|----|----|-----|----|----|----|----|----|----|----|--------------|----|----|----|
| 0 | X | X | X | C3 | C2 | C1 | C0 | A3 | A2 | A1 | A0 | D15 | D14 | D13 | D12 | D11 | D10 | D9 | D8 | D7 | D6 | D5 | D4 | D3 | D2 | D1 | D0 | F3 | F2 | F1 | F0 |
| -- Prefix Bits -- | | | | - Control Bits - | | | | Address Bits | | | | ----- Data Bits ----- | | | | | | | | | | | | | | | | Feature Bits | | | |

Table 2. DAC8168 Data Input Register Format

| DB31 | | | | DB27 | | | | DB23 | | | | DB19 | | | | DB4 | | | | DB0 | | | | | | | | | | | |
|-------------------|---|---|---|------------------|----|----|----|--------------|----|----|----|-----------------------|-----|-----|-----|-----|----|----|----|-----|----|----|----|--------------|----|---|---|----|----|----|----|
| 0 | X | X | X | C3 | C2 | C1 | C0 | A3 | A2 | A1 | A0 | D13 | D12 | D11 | D10 | D9 | D8 | D7 | D6 | D5 | D4 | D3 | D2 | D1 | D0 | X | X | F3 | F2 | F1 | F0 |
| -- Prefix Bits -- | | | | - Control Bits - | | | | Address Bits | | | | ----- Data Bits ----- | | | | | | | | | | | | Feature Bits | | | | | | | |

Table 3. DAC7568 Data Input Register Format

| DB31 | | | | DB27 | | | | DB23 | | | | DB19 | | | | DB4 | | | | DB0 | | | | | | | | | | | |
|-------------------|---|---|---|------------------|----|----|----|--------------|----|----|----|-----------------------|-----|----|----|-----|----|----|----|-----|----|----|----|--------------|---|---|---|----|----|----|----|
| 0 | X | X | X | C3 | C2 | C1 | C0 | A3 | A2 | A1 | A0 | D11 | D10 | D9 | D8 | D7 | D6 | D5 | D4 | D3 | D2 | D1 | D0 | X | X | X | X | F3 | F2 | F1 | F0 |
| -- Prefix Bits -- | | | | - Control Bits - | | | | Address Bits | | | | ----- Data Bits ----- | | | | | | | | | | | | Feature Bits | | | | | | | |

DAC7568, DAC8168, DAC8568

SBAS430F – JANUARY 2009 – REVISED APRIL 2018

www.ti.com
Table 4. Control Matrix for the DAC7568, DAC8168, and DAC8568

| DB31 | DB30-DB28 | DB27 | DB26 | DB25 | DB24 | DB23 | DB22 | DB21 | DB20 | DB19 | DB18 | DB17 | DB16-DB10 | DB9 | DB8 | DB7 | DB6 | DB5 | DB4 | DB3 | DB2 | DB1 | DB0 | DESCRIPTION |
|---|------------|------|------|------|------|------|------|------|------|------|------|------|-----------|------|-----|-------|-------|-------|-------|-------|-------|-------|-------|---|
| 0 | Don't Care | C3 | C2 | C1 | C0 | A3 | A2 | A1 | A0 | D16 | D15 | D14 | D13-D7 | D6 | D5 | D4 | D3 | D2 | D1 | F3 | F2 | F1 | F0 | GENERAL DATA FORMAT FOR 16-BIT DAC8568 |
| 0 | Don't Care | C3 | C2 | C1 | C0 | A3 | A2 | A1 | A0 | D14 | D13 | D12 | D11-D5 | D4 | D3 | D2 | D1 | X | X | F3 | F2 | F1 | F0 | GENERAL DATA FORMAT FOR 14-BIT DAC8168 |
| 0 | Don't Care | C3 | C2 | C1 | C0 | A3 | A2 | A1 | A0 | D12 | D11 | D10 | D9-D3 | D2 | D1 | X | X | X | X | F3 | F2 | F1 | F0 | GENERAL DATA FORMAT FOR 12-BIT DAC7568 |
| 1 | X | X | X | X | X | X | X | X | X | X | X | X | X | X | X | X | X | X | X | X | X | X | X | Reserved Bit - Not valid; device does not perform to specified conditions |
| Write to Selected DAC Input Register | | | | | | | | | | | | | | | | | | | | | | | | |
| 0 | X | 0 | 0 | 0 | 0 | 0 | 0 | 0 | 0 | | | | | Data | | | | | | X | X | X | X | Write to input register - DAC Channel A |
| 0 | X | 0 | 0 | 0 | 0 | 0 | 0 | 0 | 1 | | | | | Data | | | | | | X | X | X | X | Write to input register - DAC Channel B |
| 0 | X | 0 | 0 | 0 | 0 | 0 | 0 | 1 | 0 | | | | | Data | | | | | | X | X | X | X | Write to input register - DAC Channel C |
| 0 | X | 0 | 0 | 0 | 0 | 0 | 0 | 1 | 1 | | | | | Data | | | | | | X | X | X | X | Write to input register - DAC Channel D |
| 0 | X | 0 | 0 | 0 | 0 | 0 | 1 | 0 | 0 | | | | | Data | | | | | | X | X | X | X | Write to input register - DAC Channel E |
| 0 | X | 0 | 0 | 0 | 0 | 0 | 1 | 0 | 1 | | | | | Data | | | | | | X | X | X | X | Write to input register - DAC Channel F |
| 0 | X | 0 | 0 | 0 | 0 | 0 | 1 | 1 | 0 | | | | | Data | | | | | | X | X | X | X | Write to input register - DAC Channel G |
| 0 | X | 0 | 0 | 0 | 0 | 0 | 1 | 1 | 1 | | | | | Data | | | | | | X | X | X | X | Write to input register - DAC Channel H |
| 0 | X | 0 | 0 | 0 | 0 | 1 | X | X | X | | | | | X | | | | | | X | X | X | X | Invalid code - No DAC channel is updated |
| 0 | X | 0 | 0 | 0 | 0 | 1 | 1 | 1 | 1 | | | | | Data | | | | | | X | X | X | X | Broadcast mode - Write to all DAC channels |
| Update Selected DAC Registers | | | | | | | | | | | | | | | | | | | | | | | | |
| 0 | X | 0 | 0 | 0 | 1 | 0 | 0 | 0 | 0 | | | | | Data | | | | | | X | X | X | X | Update DAC register - DAC Channel A |
| 0 | X | 0 | 0 | 0 | 1 | 0 | 0 | 0 | 1 | | | | | Data | | | | | | X | X | X | X | Update DAC register - DAC Channel B |
| 0 | X | 0 | 0 | 0 | 1 | 0 | 0 | 1 | 0 | | | | | Data | | | | | | X | X | X | X | Update DAC register - DAC Channel C |
| 0 | X | 0 | 0 | 0 | 1 | 0 | 0 | 1 | 1 | | | | | Data | | | | | | X | X | X | X | Update DAC register - DAC Channel D |
| 0 | X | 0 | 0 | 0 | 1 | 0 | 1 | 0 | 0 | | | | | Data | | | | | | X | X | X | X | Update DAC register - DAC Channel E |
| 0 | X | 0 | 0 | 0 | 1 | 0 | 1 | 0 | 1 | | | | | Data | | | | | | X | X | X | X | Update DAC register - DAC Channel F |
| 0 | X | 0 | 0 | 0 | 1 | 0 | 1 | 1 | 0 | | | | | Data | | | | | | X | X | X | X | Update DAC register - DAC Channel G |
| 0 | X | 0 | 0 | 0 | 1 | 0 | 1 | 1 | 1 | | | | | Data | | | | | | X | X | X | X | Update DAC register - DAC Channel H |
| 0 | X | 0 | 0 | 0 | 1 | 1 | X | X | X | | | | | X | | | | | | X | X | X | X | Invalid code - No DAC channel is updated |
| 0 | X | 0 | 0 | 0 | 1 | 1 | 1 | 1 | 1 | | | | | Data | | | | | | X | X | X | X | Broadcast mode - Update all DAC registers |
| Write to Clear Code Register | | | | | | | | | | | | | | | | | | | | | | | | |
| 0 | X | 0 | 1 | 0 | 1 | X | X | X | X | X | X | X | X | X | X | X | X | X | X | X | X | 0 | 0 | Write to clear code register; clear to zero scale |
| 0 | X | 0 | 1 | 0 | 1 | X | X | X | X | X | X | X | X | X | X | X | X | X | X | X | X | 0 | 1 | Write to clear code register; clear to midscale |
| 0 | X | 0 | 1 | 0 | 1 | X | X | X | X | X | X | X | X | X | X | X | X | X | X | X | X | 1 | 0 | Write to clear code register; clear to full-scale |
| 0 | X | 0 | 1 | 0 | 1 | X | X | X | X | X | X | X | X | X | X | X | X | X | X | X | X | 1 | 1 | Write to clear code register; ignore CLR pin |
| Write to LDAC Register | | | | | | | | | | | | | | | | | | | | | | | | |
| 0 | X | 0 | 1 | 1 | 0 | X | X | X | X | X | X | X | X | X | X | DAC H | DAC G | DAC F | DAC E | DAC D | DAC C | DAC B | DAC A | Write to LDAC register. Default setting of these bits is '0'. If bit is set to '1', the LDAC pin is overridden. See the LDAC Functionality section for details. |
| Software Reset | | | | | | | | | | | | | | | | | | | | | | | | |
| 0 | X | 0 | 1 | 1 | 1 | X | X | X | X | X | X | X | X | X | X | X | X | X | X | X | X | X | X | Software reset (power-on reset) |

Table 4. Control Matrix for the DAC7568, DAC8168, and DAC8568 (continued)

| DB31 | DB30-DB28 | DB27 | DB26 | DB25 | DB24 | DB23 | DB22 | DB21 | DB20 | DB19 | DB18 | DB17 | DB16-DB10 | DB9 | DB8 | DB7 | DB6 | DB5 | DB4 | DB3 | DB2 | DB1 | DB0 | DESCRIPTION | | | |
|--|------------|------|------|------|------|------|------|------|------|------|------|------|-----------|-----|-----|-----|-----|-----|-----|-----|-----|-----|-----|--|--|--|--|
| 0 | Don't Care | C3 | C2 | C1 | C0 | A3 | A2 | A1 | A0 | D16 | D15 | D14 | D13-D7 | D6 | D5 | D4 | D3 | D2 | D1 | F3 | F2 | F1 | F0 | GENERAL DATA FORMAT FOR 16-BIT DAC8568 | | | |
| 0 | Don't Care | C3 | C2 | C1 | C0 | A3 | A2 | A1 | A0 | D14 | D13 | D12 | D11-D5 | D4 | D3 | D2 | D1 | X | X | F3 | F2 | F1 | F0 | GENERAL DATA FORMAT FOR 14-BIT DAC8168 | | | |
| 0 | Don't Care | C3 | C2 | C1 | C0 | A3 | A2 | A1 | A0 | D12 | D11 | D10 | D9-D3 | D2 | D1 | X | X | X | X | F3 | F2 | F1 | F0 | GENERAL DATA FORMAT FOR 12-BIT DAC7568 | | | |
| Write to Selected DAC Input Register and Update All DAC Registers | | | | | | | | | | | | | | | | | | | | | | | | | | | |
| 0 | X | 0 | 0 | 1 | 0 | 0 | 0 | 0 | 0 | Data | | | | | | | | | | X | X | X | X | Write to DAC input register Ch A and update all DAC registers (SW LDAC) | | | |
| 0 | X | 0 | 0 | 1 | 0 | 0 | 0 | 0 | 1 | Data | | | | | | | | | | X | X | X | X | Write to DAC Input Register Ch B and update all DAC registers (SW LDAC) | | | |
| 0 | X | 0 | 0 | 1 | 0 | 0 | 0 | 1 | 0 | Data | | | | | | | | | | X | X | X | X | Write to DAC Input Register Ch C and update all DAC registers (SW LDAC) | | | |
| 0 | X | 0 | 0 | 1 | 0 | 0 | 0 | 1 | 1 | Data | | | | | | | | | | X | X | X | X | Write to DAC Input Register Ch D and update all DAC registers (SW LDAC) | | | |
| 0 | X | 0 | 0 | 1 | 0 | 0 | 1 | 0 | 0 | Data | | | | | | | | | | X | X | X | X | Write to DAC Input Register Ch E and update all DAC registers (SW LDAC) | | | |
| 0 | X | 0 | 0 | 1 | 0 | 0 | 1 | 0 | 1 | Data | | | | | | | | | | X | X | X | X | Write to DAC Input Register Ch F and update all DAC registers (SW LDAC) | | | |
| 0 | X | 0 | 0 | 1 | 0 | 0 | 1 | 1 | 0 | Data | | | | | | | | | | X | X | X | X | Write to DAC Input Register Ch G and update all DAC registers (SW LDAC) | | | |
| 0 | X | 0 | 0 | 1 | 0 | 0 | 1 | 1 | 1 | Data | | | | | | | | | | X | X | X | X | Write to DAC Input Register Ch H and update all DAC registers (SW LDAC) | | | |
| 0 | X | 0 | 0 | 1 | 0 | 1 | X | X | X | X | | | | | | | | | | X | X | X | X | Invalid code - No DAC Channel is updated | | | |
| 0 | X | 0 | 0 | 1 | 0 | 1 | 1 | 1 | 1 | Data | | | | | | | | | | X | X | X | X | Broadcast mode - Write to all DAC input registers and update all DAC registers (SW LDAC) | | | |
| Write to Selected DAC Input Register and Update Respective DAC Register | | | | | | | | | | | | | | | | | | | | | | | | | | | |
| 0 | X | 0 | 0 | 1 | 1 | 0 | 0 | 0 | 0 | Data | | | | | | | | | | X | X | X | X | Write to DAC input register Ch A and update DAC register Ch A | | | |
| 0 | X | 0 | 0 | 1 | 1 | 0 | 0 | 0 | 1 | Data | | | | | | | | | | X | X | X | X | Write to DAC Input Register Ch B and update DAC register Ch B | | | |
| 0 | X | 0 | 0 | 1 | 1 | 0 | 0 | 1 | 0 | Data | | | | | | | | | | X | X | X | X | Write to DAC Input Register Ch C and update DAC register Ch C | | | |
| 0 | X | 0 | 0 | 1 | 1 | 0 | 0 | 1 | 1 | Data | | | | | | | | | | X | X | X | X | Write to DAC Input Register Ch D and update DAC register Ch D | | | |
| 0 | X | 0 | 0 | 1 | 1 | 0 | 1 | 0 | 0 | Data | | | | | | | | | | X | X | X | X | Write to DAC Input Register Ch E and update DAC register Ch E | | | |
| 0 | X | 0 | 0 | 1 | 1 | 0 | 1 | 0 | 1 | Data | | | | | | | | | | X | X | X | X | Write to DAC Input Register Ch F and update DAC register Ch F | | | |
| 0 | X | 0 | 0 | 1 | 1 | 0 | 1 | 1 | 0 | Data | | | | | | | | | | X | X | X | X | Write to DAC Input Register Ch G and update DAC register Ch G | | | |
| 0 | X | 0 | 0 | 1 | 1 | 0 | 1 | 1 | 1 | Data | | | | | | | | | | X | X | X | X | Write to DAC Input Register Ch H and update DAC register Ch H | | | |
| 0 | X | 0 | 0 | 1 | 1 | 1 | X | X | X | X | | | | | | | | | | X | X | X | X | Invalid code - No DAC channel is updated | | | |
| 0 | X | 0 | 0 | 1 | 1 | 1 | 1 | 1 | 1 | Data | | | | | | | | | | X | X | X | X | Broadcast mode - Write to all DAC input registers and update all DAC registers (SW LDAC) | | | |

Table 4. Control Matrix for the DAC7568, DAC8168, and DAC8568 (continued)

| DB31 | DB30-DB28 | DB27 | DB26 | DB25 | DB24 | DB23 | DB22 | DB21 | DB20 | DB19 | DB18 | DB17 | DB16-DB10 | DB9 | DB8 | DB7 | DB6 | DB5 | DB4 | DB3 | DB2 | DB1 | DB0 | DESCRIPTION |
|------------------------------------|------------|------|------|------|------|------|------|------|------|------|------|------|-----------|-----|-----|-------|-------|-------|-------|-------|-------|-------|-------|---|
| 0 | Don't Care | C3 | C2 | C1 | C0 | A3 | A2 | A1 | A0 | D16 | D15 | D14 | D13-D7 | D6 | D5 | D4 | D3 | D2 | D1 | F3 | F2 | F1 | F0 | GENERAL DATA FORMAT FOR 16-BIT DAC8568 |
| 0 | Don't Care | C3 | C2 | C1 | C0 | A3 | A2 | A1 | A0 | D14 | D13 | D12 | D11-D5 | D4 | D3 | D2 | D1 | X | X | F3 | F2 | F1 | F0 | GENERAL DATA FORMAT FOR 14-BIT DAC8168 |
| 0 | Don't Care | C3 | C2 | C1 | C0 | A3 | A2 | A1 | A0 | D12 | D11 | D10 | D9-D3 | D2 | D1 | X | X | X | X | F3 | F2 | F1 | F0 | GENERAL DATA FORMAT FOR 12-BIT DAC7568 |
| Power-Down Commands | | | | | | | | | | | | | | | | | | | | | | | | |
| 0 | X | 0 | 1 | 0 | 0 | X | X | X | X | X | X | X | X | 0 | 0 | DAC H | DAC G | DAC F | DAC E | DAC D | DAC C | DAC B | DAC A | Power-up DAC A, B, C, D, E, F, G, H by setting respective bit to '1' |
| 0 | X | 0 | 1 | 0 | 0 | X | X | X | X | X | X | X | X | 0 | 1 | DAC H | DAC G | DAC F | DAC E | DAC D | DAC C | DAC B | DAC A | Power-down DAC A, B, C, D, E, F, G, H, 1kΩ to GND by setting respective bit to '1' |
| 0 | X | 0 | 1 | 0 | 0 | X | X | X | X | X | X | X | X | 1 | 0 | DAC H | DAC G | DAC F | DAC E | DAC D | DAC C | DAC B | DAC A | Power-down DAC A, B, C, D, E, F, G, H, 100kΩ to GND by setting respective bit to '1' |
| 0 | X | 0 | 1 | 0 | 0 | X | X | X | X | X | X | X | X | 1 | 1 | DAC H | DAC G | DAC F | DAC E | DAC D | DAC C | DAC B | DAC A | Power-down DAC A, B, C, D, E, F, G, H, High-Z to GND by setting respective bit to '1' |
| Internal Reference Commands | | | | | | | | | | | | | | | | | | | | | | | | |
| 0 | X | 1 | 0 | 0 | 0 | X | X | X | X | X | X | X | X | X | X | X | X | X | X | X | X | X | 0 | Power down internal reference - static mode (default), must use external reference to operate device; see Table 8 |
| 0 | X | 1 | 0 | 0 | 0 | X | X | X | X | X | X | X | X | X | X | X | X | X | X | X | X | X | 1 | Power up internal reference - static mode; see Table 7 (NOTE: When all DACs power down, the reference powers down; when any DAC powers up, the reference powers up) |
| 0 | X | 1 | 0 | 0 | 1 | X | X | X | X | 1 | 0 | 0 | X | X | X | X | X | X | X | X | X | X | X | Power up internal reference - flexible mode; see Table 9 (NOTE: When all DACs power down, the reference powers down; when any DAC powers up, the reference powers up) |
| 0 | X | 1 | 0 | 0 | 1 | X | X | X | X | 1 | 0 | 1 | X | X | X | X | X | X | X | X | X | X | X | Power up internal reference all the time regardless of state of DACs - flexible mode; see Table 10 |
| 0 | X | 1 | 0 | 0 | 1 | X | X | X | X | 1 | 1 | 0 | X | X | X | X | X | X | X | X | X | X | X | Power down internal reference all the time regardless of state of DACs - flexible mode; see Table 11 (NOTE: External reference must be used to operate device) |
| 0 | X | 1 | 0 | 0 | 1 | X | X | X | X | 0 | 0 | 0 | X | X | X | X | X | X | X | X | X | X | X | Switching internal reference mode from flexible mode to static mode |
| Reserved Bits | | | | | | | | | | | | | | | | | | | | | | | | |
| 0 | X | 1 | 0 | 1 | 0 | X | X | X | X | X | X | X | X | X | X | X | X | X | X | X | X | X | X | Reserved Bit - not valid; device does not perform to specified conditions |
| 0 | X | 1 | 0 | 1 | 1 | X | X | X | X | X | X | X | X | X | X | X | X | X | X | X | X | X | X | Reserved Bit - not valid; device does not perform to specified conditions |
| 0 | X | 1 | 1 | 0 | 0 | X | X | X | X | X | X | X | X | X | X | X | X | X | X | X | X | X | X | Reserved Bit - not valid; device does not perform to specified conditions |
| 0 | X | 1 | 1 | 0 | 1 | X | X | X | X | X | X | X | X | X | X | X | X | X | X | X | X | X | X | Reserved Bit - not valid; device does not perform to specified conditions |
| 0 | X | 1 | 1 | 1 | 0 | X | X | X | X | X | X | X | X | X | X | X | X | X | X | X | X | X | X | Reserved Bit - not valid; device does not perform to specified conditions |
| 0 | X | 1 | 1 | 1 | 1 | X | X | X | X | X | X | X | X | X | X | X | X | X | X | X | X | X | X | Reserved Bit - not valid; device does not perform to specified conditions |

8.2.7 SYNC Interrupt

In a normal write sequence, the $\overline{\text{SYNC}}$ line stays low for at least 32 falling edges of SCLK and the addressed DAC register updates on the 32nd falling edge. However, if SYNC is brought high before the 31st falling edge, it acts as an interrupt to the write sequence; the shift register resets and the write sequence is discarded. Neither an update of the data buffer contents, DAC register contents, nor a change in the operating mode occurs (as shown in Figure 123).

8.2.8 Power-on Reset to Zero Scale or Midscale

The DAC7568, DAC8168, and DAC8568 contain a power-on reset circuit that controls the output voltage during power-up. For device grades A and C on power-up, all DAC registers are filled with zeros and the output voltages of all DAC channels are set to zero scale. For device grades B and D all DAC registers are set to have all DAC channels power up in midscale. All DAC channels remain that way until a valid write sequence and load command are made to the respective DAC channel. The power-on reset is useful in applications where it is important to know the state of the output of each DAC while the device is in the process of powering up. No device pin should be brought high before power is applied to the device. The internal reference is powered off / down by default and remains that way until a valid reference-change command is executed.

8.2.9 Clear Code Register and $\overline{\text{CLR}}$ Pin

The DAC7568, DAC8168, and DAC8568 contain a clear code register. The clear code register can be accessed via the serial peripheral interface (SPI) and is user-configurable. Bringing the $\overline{\text{CLR}}$ pin low clears the content of all DAC registers and all DAC buffers, and replaces the code with the code determined by the clear code register. The clear code register can be written to by applying the commands showed in Table 5. The control bits must be set as follows to access the clear code register that is programmed via the feature bits, F0 and F1: C3 = '0', C2 = '1', C1 = '0', and C0 = '1'. The default setting of the clear code register sets the output of all DAC channels to 0V when $\overline{\text{CLR}}$ pin is brought low. The $\overline{\text{CLR}}$ pin is falling-edge triggered; therefore, the device exits clear code mode on the 32nd falling edge of the next write sequence. If $\overline{\text{CLR}}$ pin is brought low during a write sequence, this write sequence is aborted and the DAC registers and DAC buffers are cleared as described previously.

When performing a software reset of the device, the clear code register is set back to its default mode (DB1 = DB0 = '0'). Setting the clear code register to DB1 = DB0 = '1' ignores any activity on the external $\overline{\text{CLR}}$ pin.

8.2.10 Software Reset Function

The DAC7568, DAC8168, and DAC8568 contain a software reset feature. If the software reset feature is executed, all registers inside the device are reset to default settings; that is, all DAC channels are reset to the power-on reset code (power on reset to zero scale for grades A and C; power on reset to midscale for grades B and D).

Table 5. Clear Code Register

| DB31 | DB30-DB28 | DB27 | DB26 | DB25 | DB24 | DB23 | DB22 | DB21 | DB20 | DB19-DB10 | DB9 | DB8 | DB7 | DB6 | DB5 | DB4 | DB3 | DB2 | DB1 | DB0 | DESCRIPTION |
|------|------------|------|------|------|------|------|------|------|------|-----------|-----|-----|-----|-----|-----|-----|-----|-----|-----|-----|--|
| 0 | Don't Care | C3 | C2 | C1 | C0 | A3 | A2 | A1 | A0 | D16-D7 | D6 | D5 | D4 | D3 | D2 | D1 | F3 | F2 | F1 | F0 | GENERAL DATA FORMAT |
| 0 | X | 0 | 1 | 0 | 1 | X | X | X | X | X | X | X | X | X | X | X | X | X | 0 | 0 | Clear all DAC outputs to zero scale (default mode) |
| 0 | X | 0 | 1 | 0 | 1 | X | X | X | X | X | X | X | X | X | X | X | X | X | 0 | 1 | Clear all DAC outputs to midscale |
| 0 | X | 0 | 1 | 0 | 1 | X | X | X | X | X | X | X | X | X | X | X | X | X | 1 | 0 | Clear all DAC outputs to full-scale |
| 0 | X | 0 | 1 | 0 | 1 | X | X | X | X | X | X | X | X | X | X | X | X | X | 1 | 1 | Ignore external $\overline{\text{CLR}}$ pin |

Table 6. Software Reset

| DB31 | DB30-DB28 | DB27 | DB26 | DB25 | DB24 | DB23 | DB22 | DB21 | DB20 | DB19-DB10 | DB9 | DB8 | DB7 | DB6 | DB5 | DB4 | DB3 | DB2 | DB1 | DB0 | DESCRIPTION |
|------|------------|------|------|------|------|------|------|------|------|-----------|-----|-----|-----|-----|-----|-----|-----|-----|-----|-----|---------------------|
| 0 | Don't Care | C3 | C2 | C1 | C0 | A3 | A2 | A1 | A0 | D16-D7 | D6 | D5 | D4 | D3 | D2 | D1 | F3 | F2 | F1 | F0 | GENERAL DATA FORMAT |
| 0 | X | 0 | 1 | 1 | 1 | X | X | X | X | X | X | X | X | X | X | X | X | X | X | X | Software reset |

DAC7568, DAC8168, DAC8568

SBAS430F – JANUARY 2009 – REVISED APRIL 2018

www.ti.com
8.2.11 Operating Examples: DAC7568/DAC8168/DAC8568

 For the following examples X = *don't care*; value can be either '0' or '1'.

Example 1: Write to Data Buffer A, B, G, H; Load DAC A, B, G, H Simultaneously
1st: Write to Data Buffer A:

| DB31 | DB30-DB28 | DB27 | DB26 | DB25 | DB24 | DB23 | DB22 | DB21 | DB20 | DB19-DB10 | DB9 | DB8 | DB7 | DB6 | DB5 | DB4 | DB3 | DB2 | DB1 | DB0 |
|------|------------|------|------|------|------|------|------|------|------|-----------|-----|-----|-----|-----|-----|-----|-----|-----|-----|-----|
| 0 | Don't Care | C3 | C2 | C1 | C0 | A3 | A2 | A1 | A0 | D16-D7 | D6 | D5 | D4 | D3 | D2 | D1 | F3 | F2 | F1 | F0 |
| 0 | X | 0 | 0 | 0 | 0 | 0 | 0 | 0 | 0 | DATA | | | | | | | X | X | X | X |

2nd: Write to Data Buffer B:

| DB31 | DB30-DB28 | DB27 | DB26 | DB25 | DB24 | DB23 | DB22 | DB21 | DB20 | DB19-DB10 | DB9 | DB8 | DB7 | DB6 | DB5 | DB4 | DB3 | DB2 | DB1 | DB0 |
|------|------------|------|------|------|------|------|------|------|------|-----------|-----|-----|-----|-----|-----|-----|-----|-----|-----|-----|
| 0 | Don't Care | C3 | C2 | C1 | C0 | A3 | A2 | A1 | A0 | D16-D7 | D6 | D5 | D4 | D3 | D2 | D1 | F3 | F2 | F1 | F0 |
| 0 | X | 0 | 0 | 0 | 0 | 0 | 0 | 0 | 1 | DATA | | | | | | | X | X | X | X |

3rd: Write to Data Buffer G:

| DB31 | DB30-DB28 | DB27 | DB26 | DB25 | DB24 | DB23 | DB22 | DB21 | DB20 | DB19-DB10 | DB9 | DB8 | DB7 | DB6 | DB5 | DB4 | DB3 | DB2 | DB1 | DB0 |
|------|------------|------|------|------|------|------|------|------|------|-----------|-----|-----|-----|-----|-----|-----|-----|-----|-----|-----|
| 0 | Don't Care | C3 | C2 | C1 | C0 | A3 | A2 | A1 | A0 | D16-D7 | D6 | D5 | D4 | D3 | D2 | D1 | F3 | F2 | F1 | F0 |
| 0 | X | 0 | 0 | 0 | 0 | 0 | 1 | 1 | 0 | DATA | | | | | | | X | X | X | X |

4th: Write to Data Buffer H and Simultaneously Update all DACs:

| DB31 | DB30-DB28 | DB27 | DB26 | DB25 | DB24 | DB23 | DB22 | DB21 | DB20 | DB19-DB10 | DB9 | DB8 | DB7 | DB6 | DB5 | DB4 | DB3 | DB2 | DB1 | DB0 |
|------|------------|------|------|------|------|------|------|------|------|-----------|-----|-----|-----|-----|-----|-----|-----|-----|-----|-----|
| 0 | Don't Care | C3 | C2 | C1 | C0 | A3 | A2 | A1 | A0 | D16-D7 | D6 | D5 | D4 | D3 | D2 | D1 | F3 | F2 | F1 | F0 |
| 0 | X | 0 | 0 | 1 | 0 | 0 | 1 | 1 | 1 | DATA | | | | | | | X | X | X | X |

The DAC A, DAC B, DAC G, and DAC H analog outputs simultaneously settle to the specified values upon completion of the 4th write sequence. (The DAC voltages update simultaneously after the 32nd SCLK falling edge of the fourth write cycle).

Example 2: Load New Data to DAC C, D, E, F Sequentially
1st: Write to Data Buffer C and Load DAC C: DAC C Output Settles to Specified Value Upon Completion:

| DB31 | DB30-DB28 | DB27 | DB26 | DB25 | DB24 | DB23 | DB22 | DB21 | DB20 | DB19-DB10 | DB9 | DB8 | DB7 | DB6 | DB5 | DB4 | DB3 | DB2 | DB1 | DB0 |
|------|------------|------|------|------|------|------|------|------|------|-----------|-----|-----|-----|-----|-----|-----|-----|-----|-----|-----|
| 0 | Don't Care | C3 | C2 | C1 | C0 | A3 | A2 | A1 | A0 | D16-D7 | D6 | D5 | D4 | D3 | D2 | D1 | F3 | F2 | F1 | F0 |
| 0 | X | 0 | 0 | 1 | 1 | 0 | 0 | 1 | 0 | DATA | | | | | | | X | X | X | X |

2nd: Write to Data Buffer D and Load DAC D: DAC D Output Settles to Specified Value Upon Completion:

| DB31 | DB30-DB28 | DB27 | DB26 | DB25 | DB24 | DB23 | DB22 | DB21 | DB20 | DB19-DB10 | DB9 | DB8 | DB7 | DB6 | DB5 | DB4 | DB3 | DB2 | DB1 | DB0 |
|------|------------|------|------|------|------|------|------|------|------|-----------|-----|-----|-----|-----|-----|-----|-----|-----|-----|-----|
| 0 | Don't Care | C3 | C2 | C1 | C0 | A3 | A2 | A1 | A0 | D16-D7 | D6 | D5 | D4 | D3 | D2 | D1 | F3 | F2 | F1 | F0 |
| 0 | X | 0 | 0 | 1 | 1 | 0 | 0 | 1 | 1 | DATA | | | | | | | X | X | X | X |

3rd: Write to Data Buffer E and Load DAC E: DAC E Output Settles to Specified Value Upon Completion:

| DB31 | DB30-DB28 | DB27 | DB26 | DB25 | DB24 | DB23 | DB22 | DB21 | DB20 | DB19-DB10 | DB9 | DB8 | DB7 | DB6 | DB5 | DB4 | DB3 | DB2 | DB1 | DB0 |
|------|------------|------|------|------|------|------|------|------|------|-----------|-----|-----|-----|-----|-----|-----|-----|-----|-----|-----|
| 0 | Don't Care | C3 | C2 | C1 | C0 | A3 | A2 | A1 | A0 | D16-D7 | D6 | D5 | D4 | D3 | D2 | D1 | F3 | F2 | F1 | F0 |
| 0 | X | 0 | 0 | 1 | 1 | 0 | 1 | 0 | 0 | DATA | | | | | | | X | X | X | X |

4th: Write to Data Buffer F and Load DAC F: DAC F Output Settles to Specified Value Upon Completion:

| DB31 | DB30-DB28 | DB27 | DB26 | DB25 | DB24 | DB23 | DB22 | DB21 | DB20 | DB19-DB10 | DB9 | DB8 | DB7 | DB6 | DB5 | DB4 | DB3 | DB2 | DB1 | DB0 |
|------|------------|------|------|------|------|------|------|------|------|-----------|-----|-----|-----|-----|-----|-----|-----|-----|-----|-----|
| 0 | Don't Care | C3 | C2 | C1 | C0 | A3 | A2 | A1 | A0 | D16-D7 | D6 | D5 | D4 | D3 | D2 | D1 | F3 | F2 | F1 | F0 |
| 0 | X | 0 | 0 | 1 | 1 | 0 | 1 | 0 | 1 | DATA | | | | | | | X | X | X | X |

After completion of each write cycle, the DAC analog output settles to the voltage specified.

Example 3: Power-Down DAC A, DAC B and DAC H to 1kΩ and Power-Down DAC C, DAC D, and DAC F to 100kΩ
1st: Write Power-Down Command to DAC Channel A and DAC Channel B: DAC A and DAC B to 1kΩ.

| DB31 | DB30-DB28 | DB27 | DB26 | DB25 | DB24 | DB23 | DB22 | DB21 | DB20 | DB19-DB10 | DB9 | DB8 | DB7 | DB6 | DB5 | DB4 | DB3 | DB2 | DB1 | DB0 |
|------|------------|------|------|------|------|------|------|------|------|-----------|-----|-----|-----|-----|-----|-----|-----|-----|-----|-----|
| 0 | Don't Care | C3 | C2 | C1 | C0 | A3 | A2 | A1 | A0 | D16-D7 | D6 | D5 | D4 | D3 | D2 | D1 | F3 | F2 | F1 | F0 |
| 0 | X | 0 | 1 | 0 | 0 | 0 | 0 | 0 | 0 | 0 | 0 | 1 | 0 | 0 | 0 | 0 | 0 | 0 | 1 | 1 |

2nd: Write Power-Down Command to DAC Channel H: DAC H to 1kΩ.

| DB31 | DB30-DB28 | DB27 | DB26 | DB25 | DB24 | DB23 | DB22 | DB21 | DB20 | DB19-DB10 | DB9 | DB8 | DB7 | DB6 | DB5 | DB4 | DB3 | DB2 | DB1 | DB0 |
|------|------------|------|------|------|------|------|------|------|------|-----------|-----|-----|-----|-----|-----|-----|-----|-----|-----|-----|
| 0 | Don't Care | C3 | C2 | C1 | C0 | A3 | A2 | A1 | A0 | D16-D7 | D6 | D5 | D4 | D3 | D2 | D1 | F3 | F2 | F1 | F0 |
| 0 | X | 0 | 1 | 0 | 0 | 0 | 0 | 0 | 0 | 0 | 0 | 1 | 1 | 0 | 0 | 0 | 0 | 0 | 0 | 0 |

3rd: Write Power-Down Command to DAC Channel C and DAC Channel D: DAC C and DAC D to 100kΩ.

| DB31 | DB30-DB28 | DB27 | DB26 | DB25 | DB24 | DB23 | DB22 | DB21 | DB20 | DB19-DB10 | DB9 | DB8 | DB7 | DB6 | DB5 | DB4 | DB3 | DB2 | DB1 | DB0 |
|------|------------|------|------|------|------|------|------|------|------|-----------|-----|-----|-----|-----|-----|-----|-----|-----|-----|-----|
| 0 | Don't Care | C3 | C2 | C1 | C0 | A3 | A2 | A1 | A0 | D16-D7 | D6 | D5 | D4 | D3 | D2 | D1 | F3 | F2 | F1 | F0 |
| 0 | X | 0 | 1 | 0 | 0 | 0 | 0 | 0 | 0 | 0 | 1 | 0 | 0 | 0 | 0 | 0 | 1 | 1 | 0 | 0 |

4th: Write Power-Down Command to DAC Channel F: DAC F to 100kΩ.

| DB31 | DB30-DB28 | DB27 | DB26 | DB25 | DB24 | DB23 | DB22 | DB21 | DB20 | DB19-DB10 | DB9 | DB8 | DB7 | DB6 | DB5 | DB4 | DB3 | DB2 | DB1 | DB0 |
|------|------------|------|------|------|------|------|------|------|------|-----------|-----|-----|-----|-----|-----|-----|-----|-----|-----|-----|
| 0 | Don't Care | C3 | C2 | C1 | C0 | A3 | A2 | A1 | A0 | D16-D7 | D6 | D5 | D4 | D3 | D2 | D1 | F3 | F2 | F1 | F0 |
| 0 | X | 0 | 1 | 0 | 0 | 0 | 0 | 0 | 0 | 0 | 1 | 0 | 0 | 0 | 1 | 0 | 0 | 0 | 0 | 0 |

The DAC A, DAC B, DAC C, DAC D, DAC F, and DAC H analog outputs power-down to each respective specified mode.

Example 4: Power-Down All Channels Simultaneously while Reference is Always Powered Up
1st: Write Sequence for Enabling the DAC7568, DAC8168, and DAC8568 Internal Reference All the Time:

| DB31 | DB30-DB28 | DB27 | DB26 | DB25 | DB24 | DB23 | DB22 | DB21 | DB20 | DB19 | DB18 | DB17 | DB16-DB7 | DB6 | DB5 | DB4 | DB3 | DB2 | DB1 | DB0 |
|------|------------|------|------|------|------|------|------|------|------|------|------|------|----------|-----|-----|-----|-----|-----|-----|-----|
| 0 | Don't Care | C3 | C2 | C1 | C0 | A3 | A2 | A1 | A0 | D16 | D15 | D14 | D13-D4 | D3 | D2 | D1 | F3 | F2 | F1 | F0 |
| 0 | X | 1 | 0 | 0 | 1 | X | X | X | X | 1 | 0 | 1 | X | X | X | X | X | X | X | X |

2nd: Write Sequence to Power-Down All DACs to High-Impedance:

| DB31 | DB30-DB28 | DB27 | DB26 | DB25 | DB24 | DB23 | DB22 | DB21 | DB20 | DB19-DB10 | DB9 | DB8 | DB7 | DB6 | DB5 | DB4 | DB3 | DB2 | DB1 | DB0 |
|------|------------|------|------|------|------|------|------|------|------|-----------|-----|-----|-----|-----|-----|-----|-----|-----|-----|-----|
| 0 | Don't Care | C3 | C2 | C1 | C0 | A3 | A2 | A1 | A0 | D16-D7 | D6 | D5 | D4 | D3 | D2 | D1 | F3 | F2 | F1 | F0 |
| 0 | X | 0 | 1 | 0 | 0 | X | X | X | X | X | 1 | 1 | 1 | 1 | 1 | 1 | 1 | 1 | 1 | 1 |

The DAC A, DAC B, DAC C, DAC D, DAC E, DAC F, DAC G, and DAC H analog outputs simultaneously power-down to high-impedance upon completion of the first and second write sequences, respectively.

Example 5: Write a Specific Value to All DACs while Reference is Always Powered Down
1st: Write Sequence for Disabling the DAC7568, DAC8168, and DAC8568 Internal Reference All the Time (after this sequence, these devices require an external reference source to function):

| DB31 | DB30-DB28 | DB27 | DB26 | DB25 | DB24 | DB23 | DB22 | DB21 | DB20 | DB19 | DB18 | DB17 | DB16-DB7 | DB6 | DB5 | DB4 | DB3 | DB2 | DB1 | DB0 |
|------|------------|------|------|------|------|------|------|------|------|------|------|------|----------|-----|-----|-----|-----|-----|-----|-----|
| 0 | Don't Care | C3 | C2 | C1 | C0 | A3 | A2 | A1 | A0 | D16 | D15 | D14 | D13-D4 | D3 | D2 | D1 | F3 | F2 | F1 | F0 |
| 0 | X | 1 | 0 | 0 | 1 | X | X | X | X | 1 | 1 | 0 | X | X | X | X | X | X | X | X |

2nd: Write Sequence to Write Specified Data to All DACs:

| DB31 | DB30-DB28 | DB27 | DB26 | DB25 | DB24 | DB23 | DB22 | DB21 | DB20 | DB19-DB10 | DB9 | DB8 | DB7 | DB6 | DB5 | DB4 | DB3 | DB2 | DB1 | DB0 |
|------|------------|------|------|------|------|------|------|------|------|-----------|-----|-----|-----|-----|-----|-----|-----|-----|-----|-----|
| 0 | Don't Care | C3 | C2 | C1 | C0 | A3 | A2 | A1 | A0 | D16-D7 | D6 | D5 | D4 | D3 | D2 | D1 | F3 | F2 | F1 | F0 |
| 0 | X | 0 | 0 | 1 | 1 | 1 | 1 | 1 | 1 | DATA | | | | | | | X | X | X | X |

The DAC A, DAC B, DAC C, DAC D, DAC E, DAC F, DAC G, and DAC H analog outputs simultaneously settle to the specified values upon completion of the second write sequence. (The DAC voltages update simultaneously after the 32nd SCLK falling edge of the second write cycle). Reference is always powered-down (External reference must be used for proper operation).

8.3 Device Functional Modes

8.3.1 Enable/Disable Internal Reference

The internal reference in the DAC7568, DAC8168, and DAC8568 is disabled by default for debugging, evaluation purposes, or when using an external reference. The internal reference can be powered up and powered down using a serial command that requires a 32-bit write sequence (see the [Serial Interface](#) section), as shown in [Table 7](#) and [Table 9](#). During the time that the internal reference is disabled, the DAC functions normally using an external reference. At this point, the internal reference is disconnected from the V_{REFIN}/V_{REFOUT} pin (3-state output). Do not attempt to drive the V_{REFIN}/V_{REFOUT} pin externally and internally at the same time indefinitely.

There are two modes that allow communication with the internal reference: Static and Flexible. In Flexible mode, DB19 must be set to '1'.

8.3.1.1 Static Mode

(see [Table 7](#) and [Table 8](#))

Enabling Internal Reference:

To enable the internal reference, write the 32-bit serial command shown in [Table 7](#). When performing a power cycle to reset the device, the internal reference is switched off (default mode). In the default mode, the internal reference is powered down until a valid write sequence is applied to power up the internal reference. If the internal reference is powered up, it automatically powers down when all DACs power down in any of the power-down modes (see the [Power Down Modes](#) section). The internal reference automatically powers up when any DAC is powered up.

Disabling Internal Reference:

To disable the internal reference, write the 32-bit serial command shown in [Table 8](#). When performing a power cycle to reset the device, the internal reference is put back into its default mode and switched off (default mode).

**Table 7. Write Sequence for Enabling Internal Reference (Static Mode)
(Internal Reference Powered On—0800001h)**

| DB31 | | | | DB27 | | | | DB23 | | | | DB19 | | | | DB4 | | | | DB0 | | | | | | | | | | | | |
|------|---|---|---|------|----|----|----|------|----|----|----|------|-----|-----|-----|-----|-----|----|----|-----|----|----|----|----|----|----|----|----|----|----|----|---|
| 0 | X | X | X | C3 | C2 | C1 | C0 | A3 | A2 | A1 | A0 | D15 | D14 | D13 | D12 | D11 | D10 | D9 | D8 | D7 | D6 | D5 | D4 | D3 | D2 | D1 | D0 | F3 | F2 | F1 | F0 | |
| 0 | X | X | X | 1 | 0 | 0 | 0 | X | X | X | X | X | X | X | X | X | X | X | X | X | X | X | X | X | X | X | X | X | X | X | X | 1 |

|-- Prefix Bits --| | Control Bits -| | Address Bits | |----- Data Bits -----| | Feature Bits |

**Table 8. Write Sequence for Disabling Internal Reference (Static Mode)
(Internal Reference Powered On—0800000h)**

| DB31 | | | | DB27 | | | | DB23 | | | | DB19 | | | | DB4 | | | | DB0 | | | | | | | | | | | | |
|------|---|---|---|------|----|----|----|------|----|----|----|------|-----|-----|-----|-----|-----|----|----|-----|----|----|----|----|----|----|----|----|----|----|----|---|
| 0 | X | X | X | C3 | C2 | C1 | C0 | A3 | A2 | A1 | A0 | D15 | D14 | D13 | D12 | D11 | D10 | D9 | D8 | D7 | D6 | D5 | D4 | D3 | D2 | D1 | D0 | F3 | F2 | F1 | F0 | |
| 0 | X | X | X | 1 | 0 | 0 | 0 | X | X | X | X | X | X | X | X | X | X | X | X | X | X | X | X | X | X | X | X | X | X | X | X | 0 |

|-- Prefix Bits --| | Control Bits -| | Address Bits | |----- Data Bits -----| | Feature Bits |

8.3.1.2 Flexible Mode

(see [Table 9](#), [Table 10](#), and [Table 11](#))

Enabling Internal Reference:

Method 1) To enable the internal reference, write the 32-bit serial command shown in [Table 9](#). When performing a power cycle to reset the device, the internal reference is switched off (default mode). In the default mode, the internal reference is powered down until a valid write sequence is applied to power up the internal reference. If the internal reference is powered up, it automatically powers down when all DACs power down in any of the power-down modes (see the [Power Down Modes](#) section). The internal reference powers up automatically when any DAC is powered up.

Device Functional Modes (continued)

(see [Table 9](#), [Table 10](#), and [Table 11](#))

Method 2) To always enable the internal reference, write the 32-bit serial command shown in [Table 10](#). When the internal reference is always enabled, any power-down command to the DAC channels does not change the internal reference operating mode. When performing a power cycle to reset the device, the internal reference is switched off (default mode). In the default mode, the internal reference is powered down until a valid write sequence is applied to power up the internal reference. When the internal reference is powered up, it remains powered up, regardless of the state of the DACs.

Disabling Internal Reference:

To disable the internal reference, write the 32-bit serial command shown in [Table 11](#). When performing a power cycle to reset the device, the internal reference is switched off (default mode).

When the internal reference is operated in Flexible mode, Static mode is disabled and does not work. To switch from Flexible mode to Static mode, use the command shown in [Table 12](#).

**Table 9. Write Sequence for Enabling Internal Reference (Flexible Mode)
(Internal Reference Powered On—09080000h)**

| DB31 | | | | DB27 | | | | DB23 | | | | DB19 | | | | DB4 | | | | DB0 | | | | | | | | | | | | |
|-------------------|---|---|---|------------------|----|----|----|--------------|----|----|----|-----------------------|-----|-----|-----|-----|-----|----|----|-----|----|----|----|--------------|----|----|----|----|----|----|----|---|
| 0 | X | X | X | C3 | C2 | C1 | C0 | A3 | A2 | A1 | A0 | D15 | D14 | D13 | D12 | D11 | D10 | D9 | D8 | D7 | D6 | D5 | D4 | D3 | D2 | D1 | D0 | F3 | F2 | F1 | F0 | |
| 0 | X | X | X | 1 | 0 | 0 | 1 | X | X | X | X | 1 | 0 | 0 | X | X | X | X | X | X | X | X | X | X | X | X | X | X | X | X | X | X |
| -- Prefix Bits -- | | | | - Control Bits - | | | | Address Bits | | | | ----- Data Bits ----- | | | | | | | | | | | | Feature Bits | | | | | | | | |

**Table 10. Write Sequence for Enabling Internal Reference (Flexible Mode)
(Internal Reference Always Powered On—090A0000h)**

| DB31 | | | | DB27 | | | | DB23 | | | | DB19 | | | | DB4 | | | | DB0 | | | | | | | | | | | | |
|-------------------|---|---|---|------------------|----|----|----|--------------|----|----|----|-----------------------|-----|-----|-----|-----|-----|----|----|-----|----|----|----|--------------|----|----|----|----|----|----|----|---|
| 0 | X | X | X | C3 | C2 | C1 | C0 | A3 | A2 | A1 | A0 | D15 | D14 | D13 | D12 | D11 | D10 | D9 | D8 | D7 | D6 | D5 | D4 | D3 | D2 | D1 | D0 | F3 | F2 | F1 | F0 | |
| 0 | X | X | X | 1 | 0 | 0 | 1 | X | X | X | X | 1 | 0 | 1 | X | X | X | X | X | X | X | X | X | X | X | X | X | X | X | X | X | X |
| -- Prefix Bits -- | | | | - Control Bits - | | | | Address Bits | | | | ----- Data Bits ----- | | | | | | | | | | | | Feature Bits | | | | | | | | |

**Table 11. Write Sequence for Disabling Internal Reference (Flexible Mode)
(Internal Reference Always Powered Down—090C0000h)**

| DB31 | | | | DB27 | | | | DB23 | | | | DB19 | | | | DB4 | | | | DB0 | | | | | | | | | | | | |
|-------------------|---|---|---|------------------|----|----|----|--------------|----|----|----|-----------------------|-----|-----|-----|-----|-----|----|----|-----|----|----|----|--------------|----|----|----|----|----|----|----|---|
| 0 | X | X | X | C3 | C2 | C1 | C0 | A3 | A2 | A1 | A0 | D15 | D14 | D13 | D12 | D11 | D10 | D9 | D8 | D7 | D6 | D5 | D4 | D3 | D2 | D1 | D0 | F3 | F2 | F1 | F0 | |
| 0 | X | X | X | 1 | 0 | 0 | 1 | X | X | X | X | 1 | 1 | 0 | X | X | X | X | X | X | X | X | X | X | X | X | X | X | X | X | X | X |
| -- Prefix Bits -- | | | | - Control Bits - | | | | Address Bits | | | | ----- Data Bits ----- | | | | | | | | | | | | Feature Bits | | | | | | | | |

**Table 12. Write Sequence for Switching from Flexible Mode to Static Mode for Internal Reference
(Internal Reference Always Powered Down—09000000h)**

| DB31 | | | | DB27 | | | | DB23 | | | | DB19 | | | | DB4 | | | | DB0 | | | | | | | | | | | | |
|-------------------|---|---|---|------------------|----|----|----|--------------|----|----|----|-----------------------|-----|-----|-----|-----|-----|----|----|-----|----|----|----|--------------|----|----|----|----|----|----|----|---|
| 0 | X | X | X | C3 | C2 | C1 | C0 | A3 | A2 | A1 | A0 | D15 | D14 | D13 | D12 | D11 | D10 | D9 | D8 | D7 | D6 | D5 | D4 | D3 | D2 | D1 | D0 | F3 | F2 | F1 | F0 | |
| 0 | X | X | X | 1 | 0 | 0 | 1 | X | X | X | X | 0 | 0 | 0 | X | X | X | X | X | X | X | X | X | X | X | X | X | X | X | X | X | X |
| -- Prefix Bits -- | | | | - Control Bits - | | | | Address Bits | | | | ----- Data Bits ----- | | | | | | | | | | | | Feature Bits | | | | | | | | |

8.3.2 LDAC Functionality

The DAC7568, DAC8168, and DAC8568 offer both a software and hardware simultaneous update and control function. The DAC double-buffered architecture has been designed so that new data can be entered for each DAC without disturbing the analog outputs.

DAC7568, DAC8168, and DAC8568 data updates can be performed either in *synchronous* or in *asynchronous* mode.

Device Functional Modes (continued)

In *synchronous* mode, data are updated with the falling edge of the 32nd SCLK cycle, which follows a falling edge of $\overline{\text{SYNC}}$. For such *synchronous* updates, the $\overline{\text{LDAC}}$ pin is not required and it must be connected to GND permanently.

In *asynchronous* mode, the $\overline{\text{LDAC}}$ pin is used as a negative edge triggered timing signal for simultaneous DAC updates. Multiple single-channel updates can be done in order to set different channel buffers to desired values and then make a falling edge on $\overline{\text{LDAC}}$ pin to simultaneously update the DAC output registers. Data buffers of all channels must be loaded with desired data before an $\overline{\text{LDAC}}$ falling edge. After a high-to-low $\overline{\text{LDAC}}$ transition, all DACs are simultaneously updated with the last contents of the corresponding data buffers. If the content of a data buffer is not changed, the corresponding DAC output remains unchanged after the $\overline{\text{LDAC}}$ pin is triggered.

Alternatively, all DAC outputs can be updated simultaneously using the built-in software function of $\overline{\text{LDAC}}$. The LDAC register offers additional flexibility and control by allowing the selection of which DAC channel(s) should be updated simultaneously when the $\overline{\text{LDAC}}$ pin is being brought low. The LDAC register is loaded with an 8-bit word (DB0 to DB7) using control bits C3, C2, C1, and C0 (see). The default value for each bit, and therefore for each DAC channel, is zero. The external $\overline{\text{LDAC}}$ pin operates in normal mode. If the LDAC register bit is set to '1', it overrides the $\overline{\text{LDAC}}$ pin (the $\overline{\text{LDAC}}$ pin is internally tied low for that particular DAC channel) and this DAC channel updates synchronously after the falling edge of the 32nd SCLK cycle. However, if the LDAC register bit is set to '0', the DAC channel is controlled by the $\overline{\text{LDAC}}$ pin.

The combination of software and hardware simultaneous update functions is particularly useful in applications when updating only selective DAC channels simultaneously, while keeping the other channels unaffected and updating those channels synchronously; see for more information.

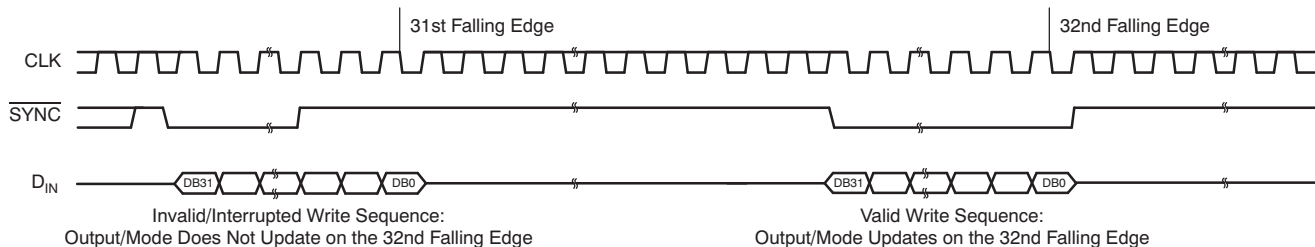

Figure 123. $\overline{\text{SYNC}}$ Interrupt Facility

8.3.3 Power-Down Modes

The DAC7568, DAC8168, and DAC8568 have two separate sets of power-down commands. One set is for the DAC channels and the other set is for the internal reference. For more information on powering down the reference, see the [Enable/Disable Internal Reference](#) section.

8.3.3.1 DAC Power-Down Commands

The DAC7568, DAC8168, and DAC8568 use four modes of operation. These modes are accessed by setting control bits C3, C2, C1, and C0, and power-down register bits DB8 and DB9. The control bits must be set to '0100'. Once the control bits are set correctly, the four different power down modes are software programmable by setting bits DB8 and DB9 in the control register. and [Table 13](#) shows how to control the operating mode with data bits PD0 (DB8), and PD1 (DB9).

Table 13. DAC Operating Modes

| PD1 (DB9) | PD0 (DB8) | DAC OPERATING MODES |
|-----------|-----------|--|
| 0 | 0 | Power up selected DACs |
| 0 | 1 | Power down selected DACs 1kΩ to GND |
| 1 | 0 | Power down selected DACs 100kΩ to GND |
| 1 | 1 | Power down selected DACs High-Z to GND |

The DAC7568, DAC8168, and DAC8568 treat the power-down condition as data; all the operational modes are still valid for power-down. It is possible to broadcast a power-down condition to all the DAC8568, DAC8168, DAC7568s in a system. It is also possible to power-down a channel and update data on other channels. Furthermore, it is possible to write to the DAC register/buffer of the DAC channel that is powered down. When the DAC channel is then powered up, it will power up to this new value (see the [Operating Examples](#) section).

When both the PD0 and PD1 bits are set to '0', the device works normally with its typical current consumption of 1.25mA at 5.5V. The reference current is included with the operation of all eight DACs. However, for the three power-down modes, the supply current falls to 0.18μA at 5.5V (0.10μA at 3.6V). Not only does the supply current fall, but the output stage also switches internally from the output of the amplifier to a resistor network of known values.

The advantage of this switching is that the output impedance of the device is known while it is in power-down mode. As described in [Table 13](#), there are three different power-down options. V_{OUT} can be connected internally to GND through a 1kΩ resistor, a 100kΩ resistor, or open circuited (High-Z). The output stage is shown in [Figure 124](#). In other words, DB27, DB26, DB25, and DB24 = '0100' and DB9 and DB8 = '11' represent a power-down condition with High-Z output impedance for a selected channel. DB9 and DB8 = '01' represents a power-down condition with 1kΩ output impedance, and '10' represents a power-down condition with 100kΩ output impedance.

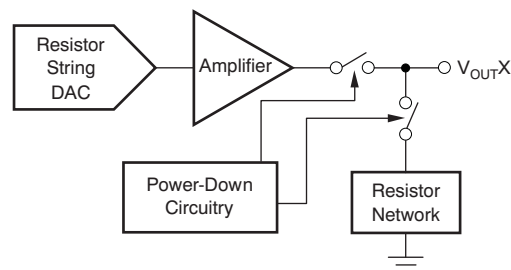

Figure 124. Output Stage During Power-Down

All analog channel circuits are shut down when the power-down mode is exercised. However, the contents of the DAC register are unaffected when in power down. By setting both bits, DB8 and DB9, to different values, any combination of DAC channels can be powered down or powered up. If a DAC channel is being powered up from a previously power down situation, this DAC channel powers up to the value in its DAC register. The time required to exit power-down is typically 2.5μs for $AV_{DD} = 5V$, and 4μs for $AV_{DD} = 3V$. See the [Typical Characteristics](#) section for more information.

9 Application and Implementation

NOTE

Information in the following applications sections is not part of the TI component specification, and TI does not warrant its accuracy or completeness. TI's customers are responsible for determining suitability of components for their purposes. Customers should validate and test their design implementation to confirm system functionality.

9.1 Application Information

Typical applications are discussed in the following section.

9.2 Typical Applications - Microprocessor Interfacing

9.2.1 DAC7568/DAC8168/DAC8568 to an 8051 Interface

Figure 125 shows a serial interface between the DAC7568, DAC8168, and DAC8568 and a typical 8051-type microcontroller. The setup for the interface is as follows: TXD of the 8051 drives SCLK of the DAC7568, DAC8168, or DAC8568, while RXD drives the serial data line of the device. The $\overline{\text{SYNC}}$ signal is derived from a bit-programmable pin on the port of the 8051; in this case, port line P3.3 is used. When data are to be transmitted to the DAC7568, DAC8168, and DAC8568, P3.3 is taken low. The 8051 transmits data in 8-bit bytes; thus, only eight falling clock edges occur in the transmit cycle. To load data to the DAC, P3.3 is left low after the first eight bits are transmitted; then, a second write cycle is initiated to transmit the second byte of data. P3.3 is taken high following the completion of the third write cycle. The 8051 outputs the serial data in a format that has the LSB first. The DAC7568, DAC8168, and DAC8568 require the data with the MSB as the first bit received. Therefore, the 8051 transmit routine must take this requirement into account, and *mirror* the data as needed.

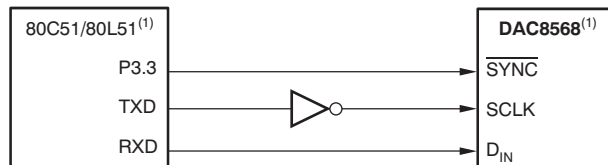

NOTE: (1) Also applies to DAC7568 and DAC8168. Additional pins omitted for clarity.

Figure 125. DAC7568/DAC8168/DAC8568 to 80C51/80L51 Interface

9.2.1.1 Detailed Design Procedure

9.2.1.1.1 Internal Reference

The internal reference of the DAC7568, DAC8168, and DAC8568 does not require an external load capacitor for stability because it is stable with any capacitive load. However, for improved noise performance, an external load capacitor of 150nF or larger connected to the $V_{\text{REFH}}/V_{\text{REFOUT}}$ output is recommended. Figure 126 shows the typical connections required for operation of the DAC7568, DAC8168, and DAC8568 internal reference. A supply bypass capacitor at the AV_{DD} input is also recommended.

Typical Applications - Microprocessor Interfacing (continued)

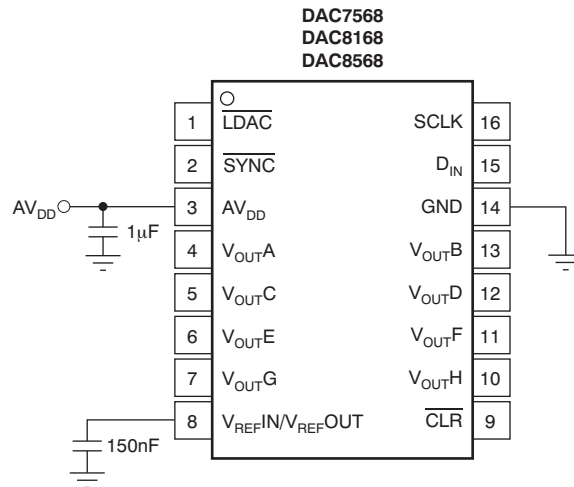

Figure 126. Typical Connections for Operating the DAC7568/DAC8168/DAC8568 Internal Reference (16-Pin Version Shown)

9.2.1.1.1.1 Supply Voltage

The internal reference features an extremely low dropout voltage. It can be operated with a supply of only 5mV above the reference output voltage in an unloaded condition. For loaded conditions, refer to the [Load Regulation](#) section. The stability of the internal reference with variations in supply voltage (line regulation, dc PSRR) is also exceptional. Within the specified supply voltage range of 2.7V to 5.5V, the variation at V_{REFH}/V_{REFOUT} is less than 10µV/V; see the [Typical Characteristics](#) section.

9.2.1.1.1.2 Temperature Drift

The internal reference is designed to exhibit minimal drift error, defined as the change in reference output voltage over varying temperature. The drift is calculated using the *box* method described by [Equation 2](#):

$$\text{Drift Error} = \left(\frac{V_{REF_MAX} - V_{REF_MIN}}{V_{REF} \times T_{RANGE}} \right) \times 10^6 \text{ (ppm/}^\circ\text{C)} \quad (2)$$

Where:

V_{REF_MAX} = maximum reference voltage observed within temperature range T_{RANGE} .

V_{REF_MIN} = minimum reference voltage observed within temperature range T_{RANGE} .

$V_{REF} = 2.5V$, target value for reference output voltage.

The internal reference (grade C only) features an exceptional typical drift coefficient of 2ppm/°C from –40°C to +125°C. Characterizing a large number of units, a maximum drift coefficient of 5ppm/°C (grade C only) is observed. Temperature drift results are summarized in the [Typical Characteristics](#) section.

9.2.1.1.1.3 Noise Performance

Typical 0.1Hz to 10Hz voltage noise can be seen in [Figure 9, Internal Reference Noise](#). Additional filtering can be used to improve output noise levels, although care should be taken to ensure the output impedance does not degrade the ac performance. The output noise spectrum at V_{REFH}/V_{REFOUT} without any external components is depicted in [Figure 8, Internal Reference Noise Density vs Frequency](#). A second noise density spectrum is also shown in [Figure 8](#). This spectrum was obtained using a 4.8µF load capacitor at V_{REFH}/V_{REFOUT} for noise filtering. Internal reference noise impacts the DAC output noise; see the [DAC Noise Performance](#) section for more details.

Typical Applications - Microprocessor Interfacing (continued)

9.2.1.1.1.4 Load Regulation

Load regulation is defined as the change in reference output voltage as a result of changes in load current. The load regulation of the internal reference is measured using force and sense contacts as shown in [Figure 127](#). The force and sense lines reduce the impact of contact and trace resistance, resulting in accurate measurement of the load regulation contributed solely by the internal reference. Measurement results are summarized in the [Typical Characteristics](#) section. Force and sense lines should be used for applications that require improved load regulation.

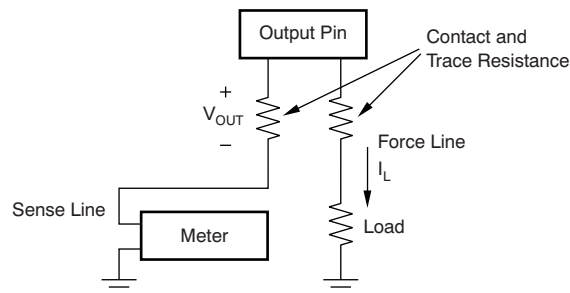

Figure 127. Accurate Load Regulation of the DAC7568/DAC8168/DAC8568 Internal Reference

9.2.1.1.1.5 Long-Term Stability

Long-term stability/aging refers to the change of the output voltage of a reference over a period of months or years. This effect lessens as time progresses (see [Figure 7](#), the typical long-term stability curve). The typical drift value for the internal reference is 50ppm from 0 hours to 1900 hours. This parameter is characterized by powering-up 20 units and measuring them at regular intervals for a period of 1900 hours.

9.2.1.1.1.6 Thermal Hysteresis

Thermal hysteresis for a reference is defined as the change in output voltage after operating the device at +25°C, cycling the device through the operating temperature range, and returning to +25°C. Hysteresis is expressed by [Equation 3](#):

$$V_{\text{HYST}} = \left[\frac{|V_{\text{REF_PRE}} - V_{\text{REF_POST}}|}{V_{\text{REF_NOM}}} \right] \times 10^6 \text{ (ppm/}^\circ\text{C)} \quad (3)$$

Where:

V_{HYST} = thermal hysteresis.

$V_{\text{REF_PRE}}$ = output voltage measured at +25°C pre-temperature cycling.

$V_{\text{REF_POST}}$ = output voltage measured after the device cycles through the temperature range of –40°C to +125°C, and returns to +25°C.

9.2.1.1.2 DAC Noise Performance

Typical noise performance for the DAC7568, DAC8168, and DAC8568 with the internal reference enabled is shown in [Figure 66](#) to [Figure 67](#). Output noise spectral density at the V_{OUT} pin versus frequency is depicted in [Figure 66](#) for full-scale, midscale, and zero-scale input codes. The typical noise density for midscale code is 120nV/ $\sqrt{\text{Hz}}$ at 1kHz and 100nV/ $\sqrt{\text{Hz}}$ at 1MHz. High-frequency noise can be improved by filtering the reference noise. Integrated output noise between 0.1Hz and 10Hz is close to 6 μV_{PP} (midscale), as shown in [Figure 67](#).

9.2.1.1.3 Bipolar Operation Using The DAC7568/DAC8168/DAC8568

The DAC7568, DAC8168, and DAC8568 are designed for single-supply operation, but a bipolar output range is also possible using the circuit in either [Figure 128](#) or [Figure 129](#). The circuit shown gives an output voltage range of $\pm V_{\text{REF}}$. Rail-to-rail operation at the amplifier output is achievable using an [OPA703](#) as the output amplifier.

The output voltage for any input code can be calculated with [Equation 4](#):

Typical Applications - Microprocessor Interfacing (continued)

$$V_{OUT} = \left[V_{REF} \times \text{Gain} \times \left[\frac{D_{IN}}{2^n} \right] \times \left[\frac{R_1 + R_2}{R_1} \right] - V_{REF} \times \left[\frac{R_2}{R_1} \right] \right] \tag{4}$$

Where:

D_{IN} = decimal equivalent of the binary code that is loaded to the DAC register. It can range from 0 to 4095 for DAC7568 (12 bit), 0 to 16,383 for DAC8168 (14 bit), and 0 to 65535 for DAC8568 (16 bit).

n = resolution in bits; either 12 (DAC7568), 14 (DAC8168) or 16 (DAC8568)

Gain = 1 for A/B grades or 2 for C/D grades.

With $V_{REFIN}/V_{REFOUT} = 5V$, $R_1 = R_2 = 10k\Omega$, for grades A and B.

$$V_{OUT} = \left[\frac{10 \times D_{IN}}{2^n} \right] - 5V \tag{5}$$

This result has an output voltage range of $\pm 5V$ with 0000h corresponding to a $-5V$ output and FFFFh corresponding to a $+5V$ output for the 16-bit DAC8568, as shown in Figure 128. Similarly, using the internal reference, a $\pm 2.5V$ output voltage range can be achieved, as Figure 129 shows.

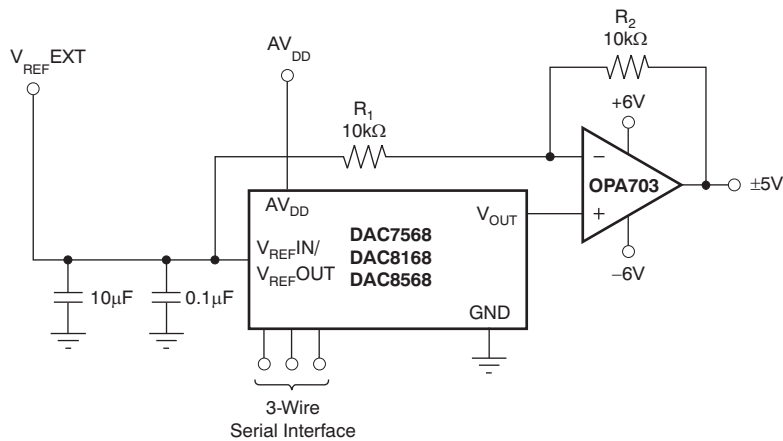

Figure 128. Bipolar Output Range Using External Reference at 5V

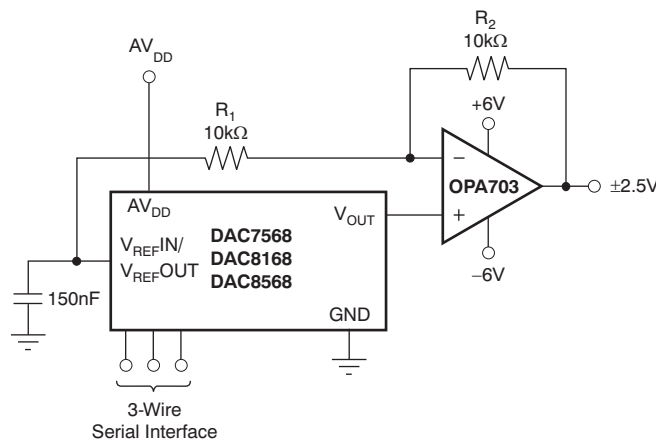
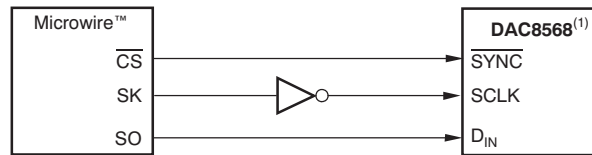

Figure 129. Bipolar Output Range Using Internal Reference

9.2.2 DAC7568/DAC8168/DAC8568 to Microwire Interface

Figure 130 shows an interface between the DAC7568, DAC8168, and DAC8568 and any Microwire-compatible device. Serial data are shifted out on the falling edge of the serial clock and are clocked into the DAC7568, DAC8168, and DAC8568 on the rising edge of the SK signal.



NOTE: (1) Also applies to DAC7568 and DAC8168. Additional pins omitted for clarity.

Figure 130. DAC7568/DAC8168/DAC8568 to Microwire Interface

9.2.3 DAC7568/DAC8168/DAC8568 to 68HC11 Interface

Figure 131 shows a serial interface between the DAC7568/DAC8168/DAC8568 and the 68HC11 microcontroller. SCK of the 68HC11 drives the SCLK of the DAC7568, DAC8168, and DAC8568, while the MOSI output drives the serial data line of the DAC. The SYNC signal derives from a port line (PC7), similar to the 8051 diagram.

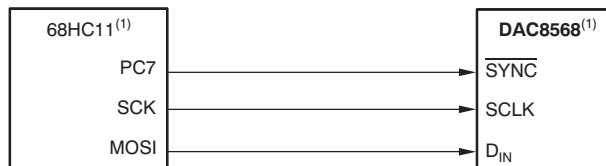

NOTE: (1) Also applies to DAC7568 and DAC8168. Additional pins omitted for clarity.

Figure 131. DAC7568/DAC8168/DAC8568 to 68HC11 Interface

The 68HC11 should be configured so that its CPOL bit is '0' and its CPHA bit is '1'. This configuration causes data appearing on the MOSI output to be valid on the falling edge of SCK. When data are being transmitted to the DAC, the SYNC line is held low (PC7). Serial data from the 68HC11 are transmitted in 8-bit bytes with only eight falling clock edges occurring in the transmit cycle. (Data are transmitted MSB first.) In order to load data to the DAC7568, DAC8168, and DAC8568, PC7 is left low after the first eight bits are transferred; then, a second and third serial write operation are performed to the DAC. PC7 is taken high at the end of this procedure.

10 Layout

10.1 Layout Guidelines

A precision analog component requires careful layout, adequate bypassing, and clean, well-regulated power supplies.

The DAC7568, DAC8168, and DAC8568 offer single-supply operation, and are often used in close proximity with digital logic, microcontrollers, microprocessors, and digital signal processors. The more digital logic present in the design and the higher the switching speed, the more difficult it is to keep digital noise from appearing at the output.

As a result of the single ground pin of the DAC7568, DAC8168, and DAC8568, all return currents (including digital and analog return currents for the DAC) must flow through a single point. Ideally, GND would be connected directly to an analog ground plane. This plane would be separate from the ground connection for the digital components until they were connected at the power-entry point of the system.

The power applied to AV_{DD} should be well-regulated and low noise. Switching power supplies and dc/dc converters often have high-frequency glitches or spikes riding on the output voltage. In addition, digital components can create similar high-frequency spikes as their internal logic switches states. This noise can easily couple into the DAC output voltage through various paths between the power connections and analog output.

As with the GND connection, AV_{DD} should be connected to a power-supply plane or trace that is separate from the connection for digital logic until they are connected at the power-entry point. In addition, a $1\mu\text{F}$ to $10\mu\text{F}$ capacitor and $0.1\mu\text{F}$ bypass capacitor are strongly recommended. In some situations, additional bypassing may be required, such as a $100\mu\text{F}$ electrolytic capacitor or even a Pi filter made up of inductors and capacitors—all designed to essentially low-pass filter the supply and remove the high-frequency noise.

11 Device and Documentation Support

11.1 Device Support

11.1.1 Device Nomenclature

With the increased complexity of many different specifications listed in product data sheets, this section summarizes selected specifications related to digital-to-analog converters.

11.1.1.1 Static Performance

Static performance parameters are specifications such as differential nonlinearity (DNL) or integral nonlinearity (INL). These are dc specifications and provide information on the accuracy of the DAC. They are most important in applications where the signal changes slowly and accuracy is required.

11.1.1.1.1 Resolution

Generally, the DAC resolution can be expressed in different forms. Specifications such as IEC 60748-4 recognize the numerical, analog, and relative resolution. The numerical resolution is defined as the number of digits in the chosen numbering system necessary to express the total number of steps of the transfer characteristic, where a step represents both a digital input code and the corresponding discrete analogue output value. The most commonly-used definition of resolution provided in data sheets is the numerical resolution expressed in bits.

11.1.1.1.2 Least Significant Bit (LSB)

The least significant bit (LSB) is defined as the smallest value in a binary coded system. The value of the LSB can be calculated by dividing the full-scale output voltage by 2^n , where n is the resolution of the converter.

11.1.1.1.3 Most Significant Bit (MSB)

The most significant bit (MSB) is defined as the largest value in a binary coded system. The value of the MSB can be calculated by dividing the full-scale output voltage by 2. Its value is one-half of full-scale.

11.1.1.1.4 Relative Accuracy or Integral Nonlinearity (INL)

Relative accuracy or integral nonlinearity (INL) is defined as the maximum deviation between the real transfer function and a straight line passing through the endpoints of the ideal DAC transfer function. DNL is measured in LSBs.

11.1.1.1.5 Differential Nonlinearity (DNL)

Differential nonlinearity (DNL) is defined as the maximum deviation of the real LSB step from the ideal 1LSB step. Ideally, any two adjacent digital codes correspond to output analog voltages that are exactly one LSB apart. If the DNL is less than 1LSB, the DAC is said to be monotonic.

11.1.1.1.6 Full-Scale Error

Full-scale error is defined as the deviation of the real full-scale output voltage from the ideal output voltage while the DAC register is loaded with the full-scale code (0xFFFF). Ideally, the output should be $AV_{DD} - 1$ LSB. The full-scale error is expressed in percent of full-scale range (%FSR).

11.1.1.1.7 Offset Error

The offset error is defined as the difference between actual output voltage and the ideal output voltage in the linear region of the transfer function. This difference is calculated by using a straight line defined by two codes (code 485 and 64714). Since the offset error is defined by a straight line, it can have a negative or positive value. Offset error is measured in mV.

11.1.1.1.8 Zero-Code Error

The zero-code error is defined as the DAC output voltage, when all '0's are loaded into the DAC register. Zero-scale error is a measure of the difference between actual output voltage and ideal output voltage (0V). It is expressed in mV. It is primarily caused by offsets in the output amplifier.

Device Support (continued)

11.1.1.1.9 Gain Error

Gain error is defined as the deviation in the slope of the real DAC transfer characteristic from the ideal transfer function. Gain error is expressed as a percentage of full-scale range (%FSR).

11.1.1.1.10 Full-Scale Error Drift

Full-scale error drift is defined as the change in full-scale error with a change in temperature. Full-scale error drift is expressed in units of %FSR/°C.

11.1.1.1.11 Offset Error Drift

Offset error drift is defined as the change in offset error with a change in temperature. Offset error drift is expressed in $\mu\text{V}/^\circ\text{C}$.

11.1.1.1.12 Zero-Code Error Drift

Zero-code error drift is defined as the change in zero-code error with a change in temperature. Zero-code error drift is expressed in $\mu\text{V}/^\circ\text{C}$.

11.1.1.1.13 Gain Temperature Coefficient

The gain temperature coefficient is defined as the change in gain error with changes in temperature. The gain temperature coefficient is expressed in ppm of FSR/°C.

11.1.1.1.14 Power-Supply Rejection Ratio (PSRR)

Power-supply rejection ratio (PSRR) is defined as the ratio of change in output voltage to a change in supply voltage for a full-scale output of the DAC. The PSRR of a device indicates how the output of the DAC is affected by changes in the supply voltage. PSRR is measured in decibels (dB).

11.1.1.1.15 Monotonicity

Monotonicity is defined as a slope whose sign does not change. If a DAC is monotonic, the output changes in the same direction or remains at least constant for each step increase (or decrease) in the input code.

11.1.1.2 Dynamic Performance

Dynamic performance parameters are specifications such as settling time or slew rate, which are important in applications where the signal rapidly changes and/or high frequency signals are present.

11.1.1.2.1 Slew Rate

The output slew rate (SR) of an amplifier or other electronic circuit is defined as the maximum rate of change of the output voltage for all possible input signals.

$$\text{SR} = \max \left(\left| \frac{\Delta V_{\text{OUT}}(t)}{\Delta t} \right| \right)$$

Where $\Delta V_{\text{OUT}}(t)$ is the output produced by the amplifier as a function of time t .

11.1.1.2.2 Output Voltage Settling Time

Settling time is the total time (including slew time) for the DAC output to settle within an error band around its final value after a change in input. Settling times are specified to within $\pm 0.003\%$ (or whatever value is specified) of full-scale range (FSR).

11.1.1.2.3 Code Change/Digital-to-Analog Glitch Energy

Digital-to-analog glitch impulse is the impulse injected into the analog output when the input code in the DAC register changes state. It is normally specified as the area of the glitch in nanovolt-seconds (nV-s), and is measured when the digital input code is changed by 1LSB at the major carry transition.

Device Support (continued)

11.1.1.2.4 Digital Feedthrough

Digital feedthrough is defined as impulse seen at the output of the DAC from the digital inputs of the DAC. It is measured when the DAC output is not updated. It is specified in nV-s, and measured with a full-scale code change on the data bus; that is, from all '0's to all '1's and vice versa.

11.1.1.2.5 Channel-to-Channel DC Crosstalk

Channel-to-channel dc crosstalk is defined as the dc change in the output level of one DAC channel in response to a change in the output of another DAC channel. It is measured with a full-scale output change on one DAC channel while monitoring another DAC channel remains at midscale. It is expressed in LSB.

11.1.1.2.6 Channel-to-Channel AC Crosstalk

AC crosstalk in a multi-channel DAC is defined as the amount of ac interference experienced on the output of a channel at a frequency (f) (and its harmonics), when the output of an adjacent channel changes its value at the rate of frequency (f). It is measured with one channel output oscillating with a sine wave of 1kHz frequency, while monitoring the amplitude of 1kHz harmonics on an adjacent DAC channel output (kept at zero scale). It is expressed in dB.

11.1.1.2.7 Signal-to-Noise Ratio (SNR)

Signal-to-noise ratio (SNR) is defined as the ratio of the root mean-squared (RMS) value of the output signal divided by the RMS values of the sum of all other spectral components below one-half the output frequency, not including harmonics or dc. SNR is measured in dB.

11.1.1.2.8 Total Harmonic Distortion (THD)

Total harmonic distortion + noise is defined as the ratio of the RMS values of the harmonics and noise to the value of the fundamental frequency. It is expressed in a percentage of the fundamental frequency amplitude at sampling rate f_s .

11.1.1.2.9 Spurious-Free Dynamic Range (SFDR)

Spurious-free dynamic range (SFDR) is the usable dynamic range of a DAC before spurious noise interferes or distorts the fundamental signal. SFDR is the measure of the difference in amplitude between the fundamental and the largest harmonically or non-harmonically related spur from dc to the full Nyquist bandwidth (half the DAC sampling rate, or $f_s/2$). A spur is any frequency bin on a spectrum analyzer, or from a Fourier transform, of the analog output of the DAC. SFDR is specified in decibels relative to the carrier (dBc).

11.1.1.2.10 Signal-to-Noise plus Distortion (SINAD)

SINAD includes all the harmonic and outstanding spurious components in the definition of output noise power in addition to quantizing any internal random noise power. SINAD is expressed in dB at a specified input frequency and sampling rate, f_s .

11.1.1.2.11 DAC Output Noise Density

Output noise density is defined as internally-generated random noise. Random noise is characterized as a spectral density (nV/ $\sqrt{\text{Hz}}$). It is measured by loading the DAC to midscale and measuring noise at the output.

11.1.1.2.12 DAC Output Noise

DAC output noise is defined as any voltage deviation of DAC output from the desired value (within a particular frequency band). It is measured with a DAC channel kept at midscale while filtering the output voltage within a band of 0.1Hz to 10Hz and measuring its amplitude peaks. It is expressed in terms of peak-to-peak voltage (V_{pp}).

11.1.1.2.13 Full-Scale Range (FSR)

Full-scale range (FSR) is the difference between the maximum and minimum analog output values that the DAC is specified to provide; typically, the maximum and minimum values are also specified. For an n -bit DAC, these values are usually given as the values matching with code 0 and 2^n .

11.2 Related Links

The table below lists quick access links. Categories include technical documents, support and community resources, tools and software, and quick access to sample or buy.

Table 14. Related Links

| PARTS | PRODUCT FOLDER | ORDER NOW | TECHNICAL DOCUMENTS | TOOLS & SOFTWARE | SUPPORT & COMMUNITY |
|---------|----------------------------|----------------------------|----------------------------|----------------------------|----------------------------|
| DAC7568 | Click here | Click here | Click here | Click here | Click here |
| DAC8168 | Click here | Click here | Click here | Click here | Click here |
| DAC8568 | Click here | Click here | Click here | Click here | Click here |

11.3 Receiving Notification of Documentation Updates

To receive notification of documentation updates, navigate to the device product folder on ti.com. In the upper right corner, click on *Alert me* to register and receive a weekly digest of any product information that has changed. For change details, review the revision history included in any revised document.

11.4 Community Resources

The following links connect to TI community resources. Linked contents are provided "AS IS" by the respective contributors. They do not constitute TI specifications and do not necessarily reflect TI's views; see TI's [Terms of Use](#).

TI E2E™ Online Community *TI's Engineer-to-Engineer (E2E) Community*. Created to foster collaboration among engineers. At e2e.ti.com, you can ask questions, share knowledge, explore ideas and help solve problems with fellow engineers.

Design Support *TI's Design Support* Quickly find helpful E2E forums along with design support tools and contact information for technical support.

11.5 Trademarks

E2E is a trademark of Texas Instruments.
 SPI, QSPI are trademarks of Motorola, Inc.
 Microwire is a trademark of National Semiconductor.
 All other trademarks are the property of their respective owners.

11.6 Electrostatic Discharge Caution



This integrated circuit can be damaged by ESD. Texas Instruments recommends that all integrated circuits be handled with appropriate precautions. Failure to observe proper handling and installation procedures can cause damage.

ESD damage can range from subtle performance degradation to complete device failure. Precision integrated circuits may be more susceptible to damage because very small parametric changes could cause the device not to meet its published specifications.

11.7 Glossary

[SLYZ022](#) — *TI Glossary*.

This glossary lists and explains terms, acronyms, and definitions.

12 Mechanical, Packaging, and Orderable Information

The following pages include mechanical, packaging, and orderable information. This information is the most current data available for the designated devices. This data is subject to change without notice and revision of this document. For browser-based versions of this data sheet, refer to the left-hand navigation.

PACKAGING INFORMATION

| Orderable Device | Status (1) | Package Type | Package Drawing | Pins | Package Qty | Eco Plan (2) | Lead/Ball Finish (6) | MSL Peak Temp (3) | Op Temp (°C) | Device Marking (4/5) | Samples |
|------------------|---------------|--------------|-----------------|------|-------------|-------------------------|-------------------------|----------------------|--------------|-------------------------|-------------------------|
| DAC7568IAPW | ACTIVE | TSSOP | PW | 14 | 90 | Green (RoHS & no Sb/Br) | CU NIPDAU | Level-2-260C-1 YEAR | -40 to 125 | DA7568A | Samples |
| DAC7568IAPWR | ACTIVE | TSSOP | PW | 14 | 2000 | Green (RoHS & no Sb/Br) | CU NIPDAU | Level-2-260C-1 YEAR | -40 to 125 | DA7568A | Samples |
| DAC7568ICPW | ACTIVE | TSSOP | PW | 16 | 90 | Green (RoHS & no Sb/Br) | CU NIPDAU | Level-2-260C-1 YEAR | -40 to 125 | DA7568C | Samples |
| DAC7568ICPWR | ACTIVE | TSSOP | PW | 16 | 2000 | Green (RoHS & no Sb/Br) | CU NIPDAU | Level-2-260C-1 YEAR | -40 to 125 | DA7568C | Samples |
| DAC8168IAPW | ACTIVE | TSSOP | PW | 14 | 90 | Green (RoHS & no Sb/Br) | CU NIPDAU | Level-2-260C-1 YEAR | -40 to 125 | DA8168A | Samples |
| DAC8168IAPWR | ACTIVE | TSSOP | PW | 14 | 2000 | Green (RoHS & no Sb/Br) | CU NIPDAU | Level-2-260C-1 YEAR | -40 to 125 | DA8168A | Samples |
| DAC8168ICPW | ACTIVE | TSSOP | PW | 16 | 90 | Green (RoHS & no Sb/Br) | CU NIPDAU | Level-2-260C-1 YEAR | -40 to 125 | DA8168C | Samples |
| DAC8168ICPWR | ACTIVE | TSSOP | PW | 16 | 2000 | Green (RoHS & no Sb/Br) | CU NIPDAU | Level-2-260C-1 YEAR | -40 to 125 | DA8168C | Samples |
| DAC8568IAPW | ACTIVE | TSSOP | PW | 16 | 90 | Green (RoHS & no Sb/Br) | CU NIPDAU | Level-2-260C-1 YEAR | -40 to 125 | DA8568A | Samples |
| DAC8568IAPWR | ACTIVE | TSSOP | PW | 16 | 2000 | Green (RoHS & no Sb/Br) | CU NIPDAU | Level-2-260C-1 YEAR | -40 to 125 | DA8568A | Samples |
| DAC8568IBPW | ACTIVE | TSSOP | PW | 16 | 90 | Green (RoHS & no Sb/Br) | CU NIPDAU | Level-2-260C-1 YEAR | -40 to 125 | DA8568B | Samples |
| DAC8568IBPWR | ACTIVE | TSSOP | PW | 16 | 2000 | Green (RoHS & no Sb/Br) | CU NIPDAU | Level-2-260C-1 YEAR | -40 to 125 | DA8568B | Samples |
| DAC8568ICPW | ACTIVE | TSSOP | PW | 16 | 90 | Green (RoHS & no Sb/Br) | CU NIPDAU | Level-2-260C-1 YEAR | -40 to 125 | DA8568C | Samples |
| DAC8568ICPWR | ACTIVE | TSSOP | PW | 16 | 2000 | Green (RoHS & no Sb/Br) | CU NIPDAU | Level-2-260C-1 YEAR | -40 to 125 | DA8568C | Samples |
| DAC8568IDPW | ACTIVE | TSSOP | PW | 16 | 90 | Green (RoHS & no Sb/Br) | CU NIPDAU | Level-2-260C-1 YEAR | -40 to 125 | DA8568D | Samples |
| DAC8568IDPWR | ACTIVE | TSSOP | PW | 16 | 2000 | Green (RoHS & no Sb/Br) | CU NIPDAU | Level-2-260C-1 YEAR | -40 to 125 | DA8568D | Samples |

(1) The marketing status values are defined as follows:
ACTIVE: Product device recommended for new designs.

LIFEBUY: TI has announced that the device will be discontinued, and a lifetime-buy period is in effect.

NRND: Not recommended for new designs. Device is in production to support existing customers, but TI does not recommend using this part in a new design.

PREVIEW: Device has been announced but is not in production. Samples may or may not be available.

OBSOLETE: TI has discontinued the production of the device.

⁽²⁾ **RoHS:** TI defines "RoHS" to mean semiconductor products that are compliant with the current EU RoHS requirements for all 10 RoHS substances, including the requirement that RoHS substance do not exceed 0.1% by weight in homogeneous materials. Where designed to be soldered at high temperatures, "RoHS" products are suitable for use in specified lead-free processes. TI may reference these types of products as "Pb-Free".

RoHS Exempt: TI defines "RoHS Exempt" to mean products that contain lead but are compliant with EU RoHS pursuant to a specific EU RoHS exemption.

Green: TI defines "Green" to mean the content of Chlorine (Cl) and Bromine (Br) based flame retardants meet JS709B low halogen requirements of ≤ 1000 ppm threshold. Antimony trioxide based flame retardants must also meet the ≤ 1000 ppm threshold requirement.

⁽³⁾ MSL, Peak Temp. - The Moisture Sensitivity Level rating according to the JEDEC industry standard classifications, and peak solder temperature.

⁽⁴⁾ There may be additional marking, which relates to the logo, the lot trace code information, or the environmental category on the device.

⁽⁵⁾ Multiple Device Markings will be inside parentheses. Only one Device Marking contained in parentheses and separated by a "~" will appear on a device. If a line is indented then it is a continuation of the previous line and the two combined represent the entire Device Marking for that device.

⁽⁶⁾ Lead/Ball Finish - Orderable Devices may have multiple material finish options. Finish options are separated by a vertical ruled line. Lead/Ball Finish values may wrap to two lines if the finish value exceeds the maximum column width.

Important Information and Disclaimer: The information provided on this page represents TI's knowledge and belief as of the date that it is provided. TI bases its knowledge and belief on information provided by third parties, and makes no representation or warranty as to the accuracy of such information. Efforts are underway to better integrate information from third parties. TI has taken and continues to take reasonable steps to provide representative and accurate information but may not have conducted destructive testing or chemical analysis on incoming materials and chemicals. TI and TI suppliers consider certain information to be proprietary, and thus CAS numbers and other limited information may not be available for release.

In no event shall TI's liability arising out of such information exceed the total purchase price of the TI part(s) at issue in this document sold by TI to Customer on an annual basis.

TAPE AND REEL INFORMATION

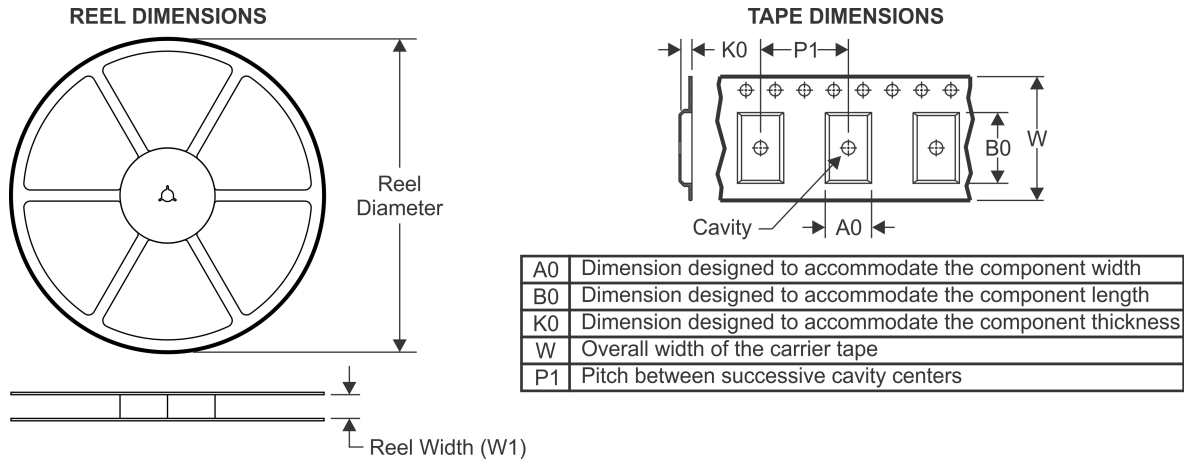

QUADRANT ASSIGNMENTS FOR PIN 1 ORIENTATION IN TAPE



*All dimensions are nominal

| Device | Package Type | Package Drawing | Pins | SPQ | Reel Diameter (mm) | Reel Width W1 (mm) | A0 (mm) | B0 (mm) | K0 (mm) | P1 (mm) | W (mm) | Pin1 Quadrant |
|--------------|--------------|-----------------|------|------|--------------------|--------------------|---------|---------|---------|---------|--------|---------------|
| DAC7568IAPWR | TSSOP | PW | 14 | 2000 | 330.0 | 12.4 | 6.9 | 5.6 | 1.6 | 8.0 | 12.0 | Q1 |
| DAC7568ICPWR | TSSOP | PW | 16 | 2000 | 330.0 | 12.4 | 6.9 | 5.6 | 1.6 | 8.0 | 12.0 | Q1 |
| DAC8168IAPWR | TSSOP | PW | 14 | 2000 | 330.0 | 12.4 | 6.9 | 5.6 | 1.6 | 8.0 | 12.0 | Q1 |
| DAC8168ICPWR | TSSOP | PW | 16 | 2000 | 330.0 | 12.4 | 6.9 | 5.6 | 1.6 | 8.0 | 12.0 | Q1 |
| DAC8568IAPWR | TSSOP | PW | 16 | 2000 | 330.0 | 12.4 | 6.9 | 5.6 | 1.6 | 8.0 | 12.0 | Q1 |
| DAC8568IBPWR | TSSOP | PW | 16 | 2000 | 330.0 | 12.4 | 6.9 | 5.6 | 1.6 | 8.0 | 12.0 | Q1 |
| DAC8568ICPWR | TSSOP | PW | 16 | 2000 | 330.0 | 12.4 | 6.9 | 5.6 | 1.6 | 8.0 | 12.0 | Q1 |
| DAC8568IDPWR | TSSOP | PW | 16 | 2000 | 330.0 | 12.4 | 6.9 | 5.6 | 1.6 | 8.0 | 12.0 | Q1 |

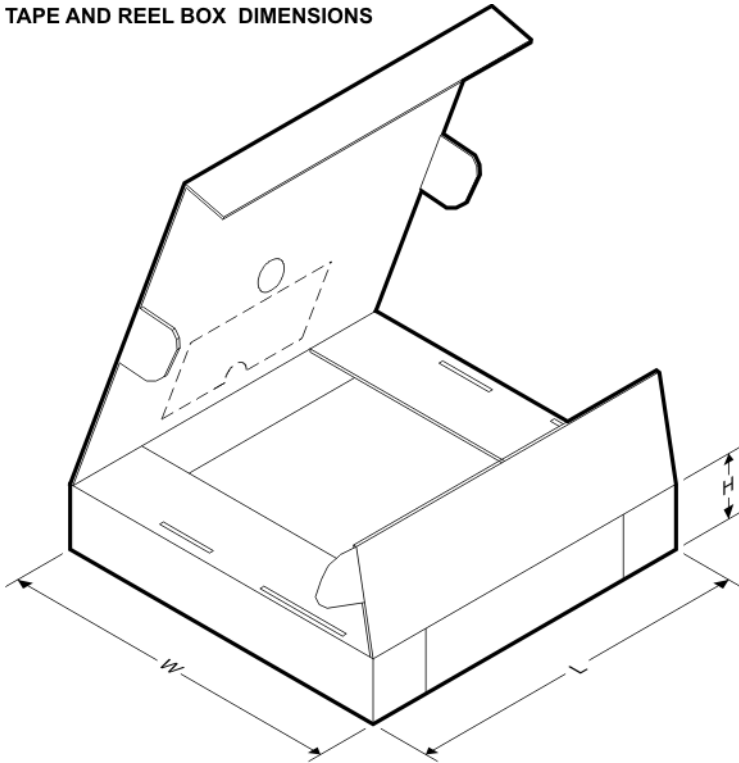
TAPE AND REEL BOX DIMENSIONS

*All dimensions are nominal

| Device | Package Type | Package Drawing | Pins | SPQ | Length (mm) | Width (mm) | Height (mm) |
|--------------|--------------|-----------------|------|------|-------------|------------|-------------|
| DAC7568IAPWR | TSSOP | PW | 14 | 2000 | 350.0 | 350.0 | 43.0 |
| DAC7568ICPWR | TSSOP | PW | 16 | 2000 | 367.0 | 367.0 | 35.0 |
| DAC8168IAPWR | TSSOP | PW | 14 | 2000 | 350.0 | 350.0 | 43.0 |
| DAC8168ICPWR | TSSOP | PW | 16 | 2000 | 350.0 | 350.0 | 43.0 |
| DAC8568IAPWR | TSSOP | PW | 16 | 2000 | 367.0 | 367.0 | 35.0 |
| DAC8568IBPWR | TSSOP | PW | 16 | 2000 | 367.0 | 367.0 | 35.0 |
| DAC8568ICPWR | TSSOP | PW | 16 | 2000 | 367.0 | 367.0 | 35.0 |
| DAC8568IDPWR | TSSOP | PW | 16 | 2000 | 367.0 | 367.0 | 35.0 |

PW (R-PDSO-G14)

PLASTIC SMALL OUTLINE

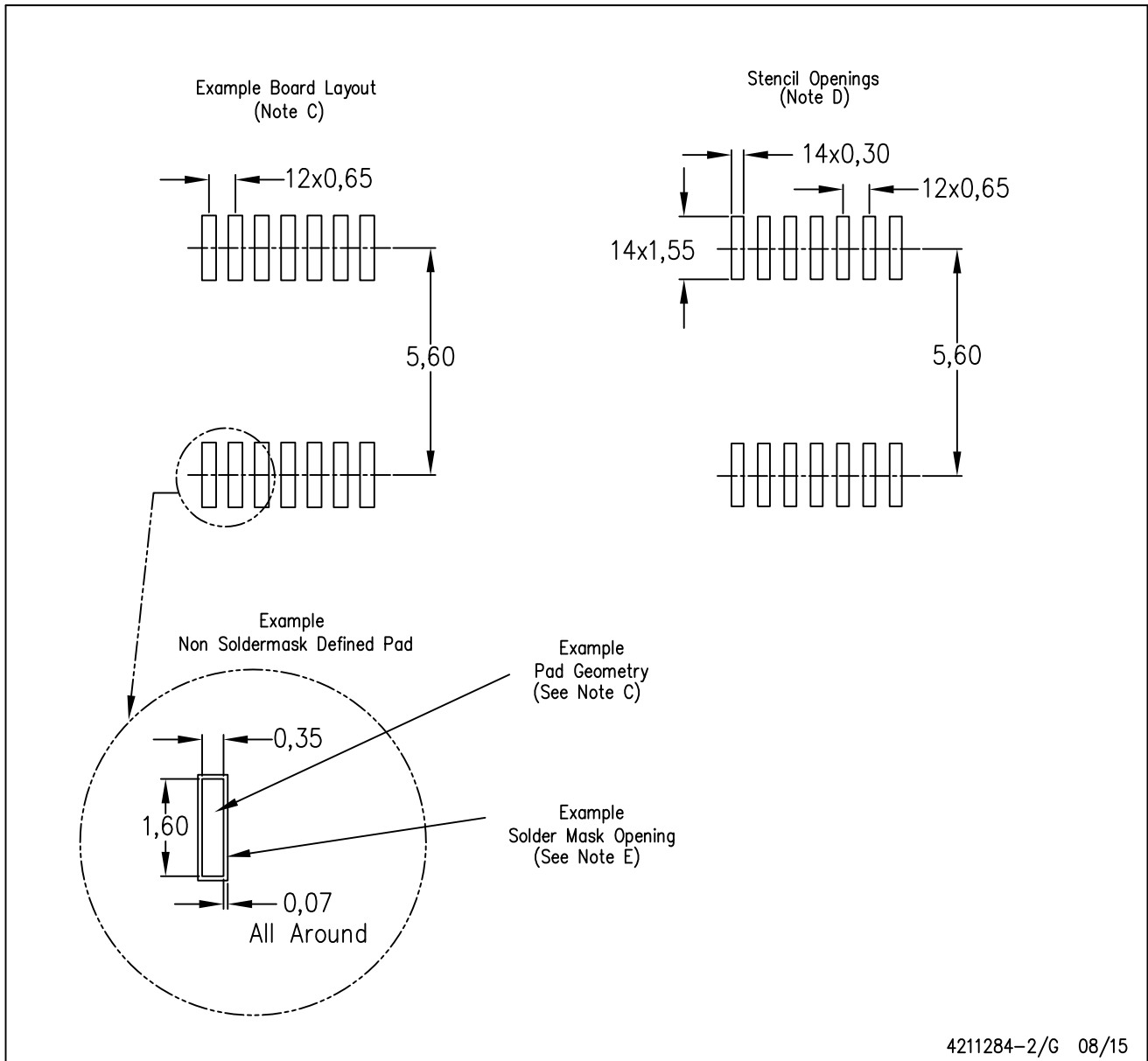

4211284-2/G 08/15

- NOTES:
- All linear dimensions are in millimeters.
 - This drawing is subject to change without notice.
 - Publication IPC-7351 is recommended for alternate designs.
 - Laser cutting apertures with trapezoidal walls and also rounding corners will offer better paste release. Customers should contact their board assembly site for stencil design recommendations. Refer to IPC-7525 for other stencil recommendations.
 - Customers should contact their board fabrication site for solder mask tolerances between and around signal pads.

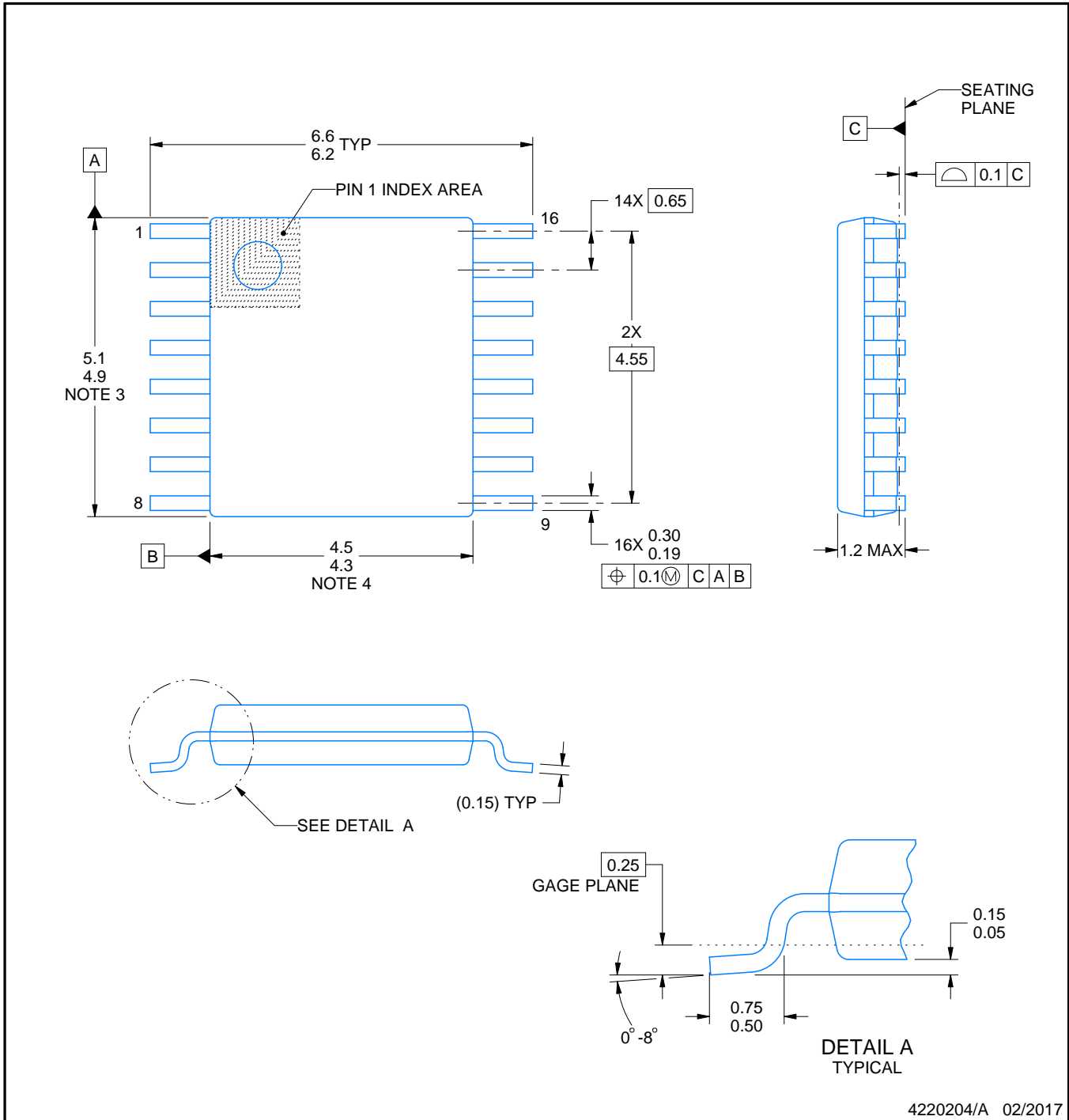
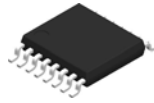

4220204/A 02/2017

NOTES:

1. All linear dimensions are in millimeters. Any dimensions in parenthesis are for reference only. Dimensioning and tolerancing per ASME Y14.5M.
2. This drawing is subject to change without notice.
3. This dimension does not include mold flash, protrusions, or gate burrs. Mold flash, protrusions, or gate burrs shall not exceed 0.15 mm per side.
4. This dimension does not include interlead flash. Interlead flash shall not exceed 0.25 mm per side.
5. Reference JEDEC registration MO-153.

EXAMPLE BOARD LAYOUT

PW0016A

TSSOP - 1.2 mm max height

SMALL OUTLINE PACKAGE

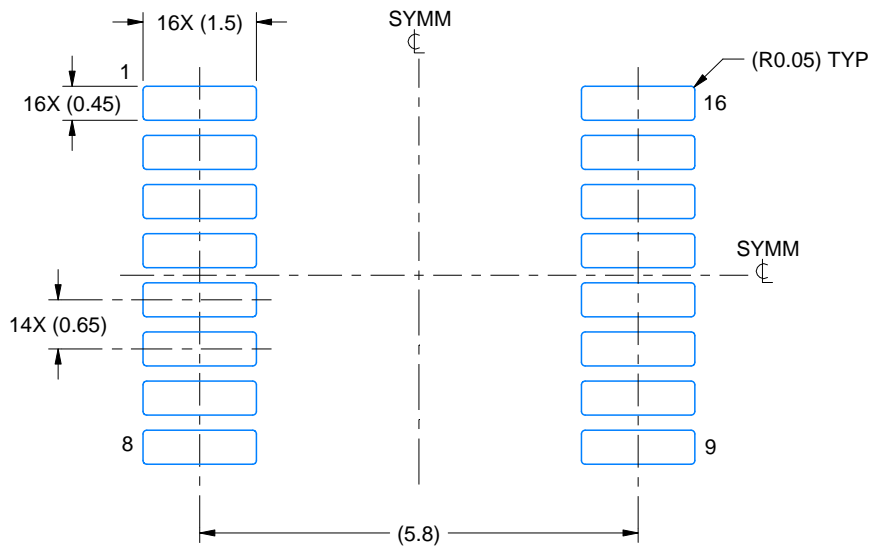

LAND PATTERN EXAMPLE
EXPOSED METAL SHOWN
SCALE: 10X

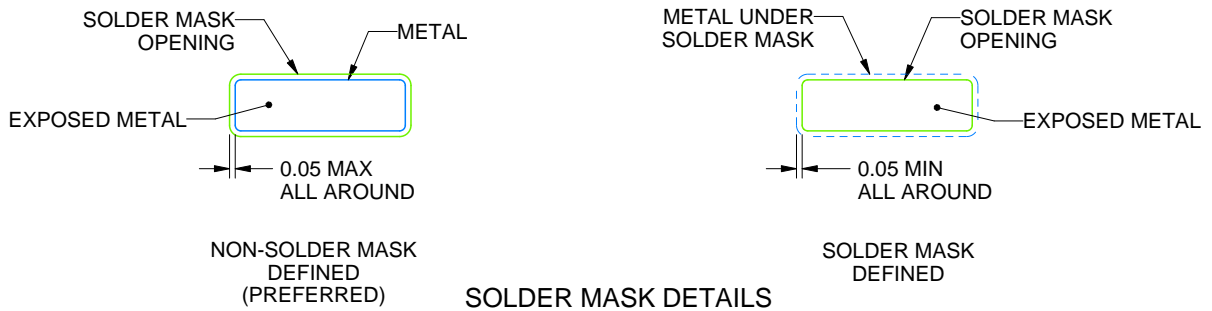

SOLDER MASK DETAILS

4220204/A 02/2017

NOTES: (continued)

- 6. Publication IPC-7351 may have alternate designs.
- 7. Solder mask tolerances between and around signal pads can vary based on board fabrication site.

EXAMPLE STENCIL DESIGN

PW0016A

TSSOP - 1.2 mm max height

SMALL OUTLINE PACKAGE

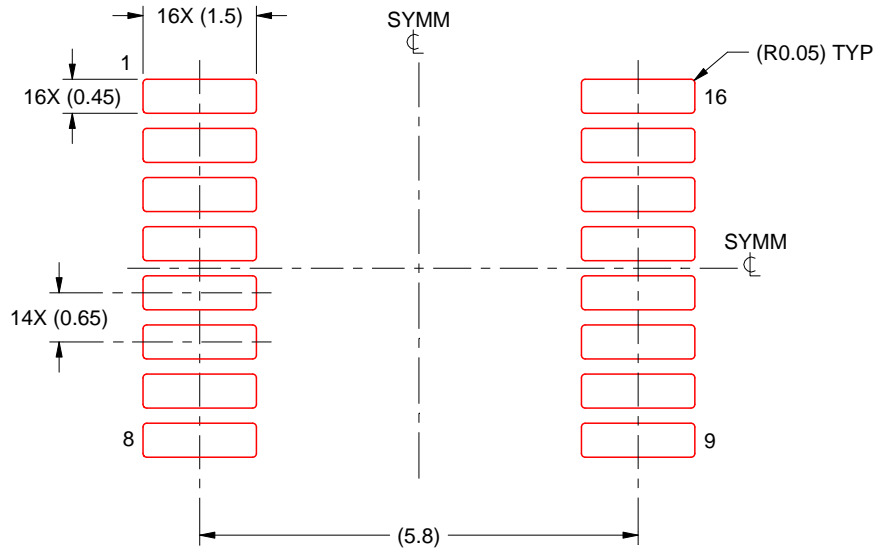

SOLDER PASTE EXAMPLE
BASED ON 0.125 mm THICK STENCIL
SCALE: 10X

4220204/A 02/2017

NOTES: (continued)

8. Laser cutting apertures with trapezoidal walls and rounded corners may offer better paste release. IPC-7525 may have alternate design recommendations.
9. Board assembly site may have different recommendations for stencil design.

IMPORTANT NOTICE AND DISCLAIMER

TI PROVIDES TECHNICAL AND RELIABILITY DATA (INCLUDING DATASHEETS), DESIGN RESOURCES (INCLUDING REFERENCE DESIGNS), APPLICATION OR OTHER DESIGN ADVICE, WEB TOOLS, SAFETY INFORMATION, AND OTHER RESOURCES "AS IS" AND WITH ALL FAULTS, AND DISCLAIMS ALL WARRANTIES, EXPRESS AND IMPLIED, INCLUDING WITHOUT LIMITATION ANY IMPLIED WARRANTIES OF MERCHANTABILITY, FITNESS FOR A PARTICULAR PURPOSE OR NON-INFRINGEMENT OF THIRD PARTY INTELLECTUAL PROPERTY RIGHTS.

These resources are intended for skilled developers designing with TI products. You are solely responsible for (1) selecting the appropriate TI products for your application, (2) designing, validating and testing your application, and (3) ensuring your application meets applicable standards, and any other safety, security, or other requirements. These resources are subject to change without notice. TI grants you permission to use these resources only for development of an application that uses the TI products described in the resource. Other reproduction and display of these resources is prohibited. No license is granted to any other TI intellectual property right or to any third party intellectual property right. TI disclaims responsibility for, and you will fully indemnify TI and its representatives against, any claims, damages, costs, losses, and liabilities arising out of your use of these resources.

TI's products are provided subject to TI's Terms of Sale (www.ti.com/legal/termsofsale.html) or other applicable terms available either on ti.com or provided in conjunction with such TI products. TI's provision of these resources does not expand or otherwise alter TI's applicable warranties or warranty disclaimers for TI products.

Mailing Address: Texas Instruments, Post Office Box 655303, Dallas, Texas 75265
Copyright © 2019, Texas Instruments Incorporated

Looking for pricing, stock, or lifecycle information?

Click below to explore more details on WIN SOURCE:

 [View DAC8568ICPWR on WIN SOURCE](#)

 [Texas Instruments](#) Information

Optimize Your Supply Chain with WIN SOURCE Solutions

-  Global Sourcing Solution
-  Obsolete Management
-  Cost Control Management
-  Shortage Management
-  Alternative Solution
-  Excess Inventory Management