



**THE DATASHEET OF
NCV8518BPWR2G**



NCV8518B

Low Dropout Linear Regulator with Watchdog, Wake Up, RESET, and ENABLE

The NCV8518B device is a precision micropower voltage regulator. It has a fixed output voltage of 5.0 V and regulates within $\pm 2\%$. It is suitable for use in all automotive environments and contains all the required functions to control a microprocessor. This device has low dropout voltage and low quiescent current. It includes a watchdog timer, adjustable reset, wake up and enable function. Also encompassed in this device are safety features such as thermal shutdown and short circuit protection. It is capable of handling up to 45 V transients.

Features

- Output Voltage of 5.0 V
- $\pm 2\%$ Output Voltage Tolerance
- Output Current up to 250 mA
- Micropower Compatible Control Functions:
 - ENABLE
 - Watchdog
 - RESET
 - Wake Up
- NCV Prefix for Automotive and Other Applications Requiring Site and Change Control
- Low Dropout Voltage
- Low Quiescent Current of 100 μA
- Protection Features:
 - Thermal Shutdown
 - Short Circuit
- Low Sleep Mode Current less than 1.0 μA
- AEC Qualified
- PPAP Capable
- These are Pb-Free Devices

Applications

- Tire Pressure Monitor
- Battery Powered Consumer Electronics



ON Semiconductor®

<http://onsemi.com>

MARKING DIAGRAMS

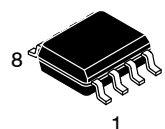

SOIC-8
EXPOSED PAD
CASE 751AC

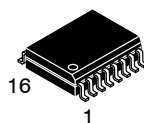
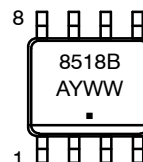

SOIC-16 LEAD
WIDE BODY
EXPOSED PAD
CASE 751AG

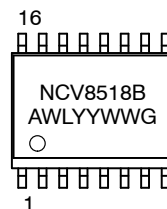

A = Assembly Location
WL = Wafer Lot
YY, Y = Year
WW = Work Week
▪ or G = Pb-Free Package

ORDERING INFORMATION

Device	Package	Shipping [†]
NCV8518BPDR2G	SOIC-8*	2500 / Tape & Reel
NCV8518BPWR2G	SOIC-16*	1000 / Tape & Reel

[†]For information on tape and reel specifications, including part orientation and tape sizes, please refer to our Tape and Reel Packaging Specifications Brochure, BRD8011/D.

*These packages are inherently Pb-Free.

NCV8518B

PIN CONNECTIONS

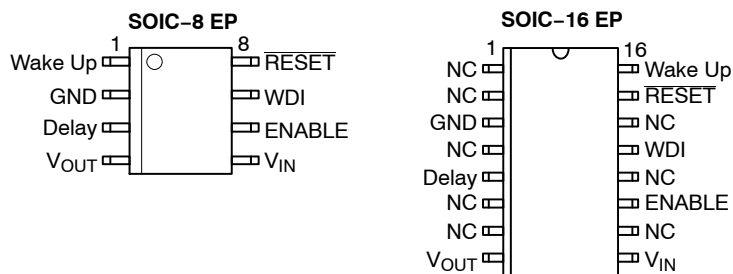

PIN FUNCTION DESCRIPTION

Pin		Symbol	Description
SOIC-8 EP	SOIC-16 EP		
4	8	V_{OUT}	Regulated output voltage.
5	9	V_{IN}	Input supply voltage.
7	13	WDI	CMOS compatible Watchdog input. The watchdog function monitors the falling edge of the incoming signal.
2	3	GND	Ground connection.
6	11	ENABLE	ENABLE control for the IC. Positive logic. If ENABLE control will not be used, connect this pin to V_{IN} via a 20k current limiting resistor. Internal ESD protection structures will clamp the maximum ENABLE voltage to approximately 21 V.
8	15	RESET	CMOS compatible output RESET goes low whenever V_{OUT} drops by more than 7.0% from nominal, or during the absence of a correct watchdog signal.
3	5	Delay	Buffered reference voltage used to create timing current for RESET and Watchdog threshold frequency from R_{Delay} .
-	1, 2, 4, 6, 7, 10, 12, 14	NC	No Connection.
1	16	Wake Up	Continuously generated signal that interrupts the microprocessor from sleep mode.
EPAD	EPAD	EPAD	Connect to Ground potential or leave unconnected.

NCV8518B

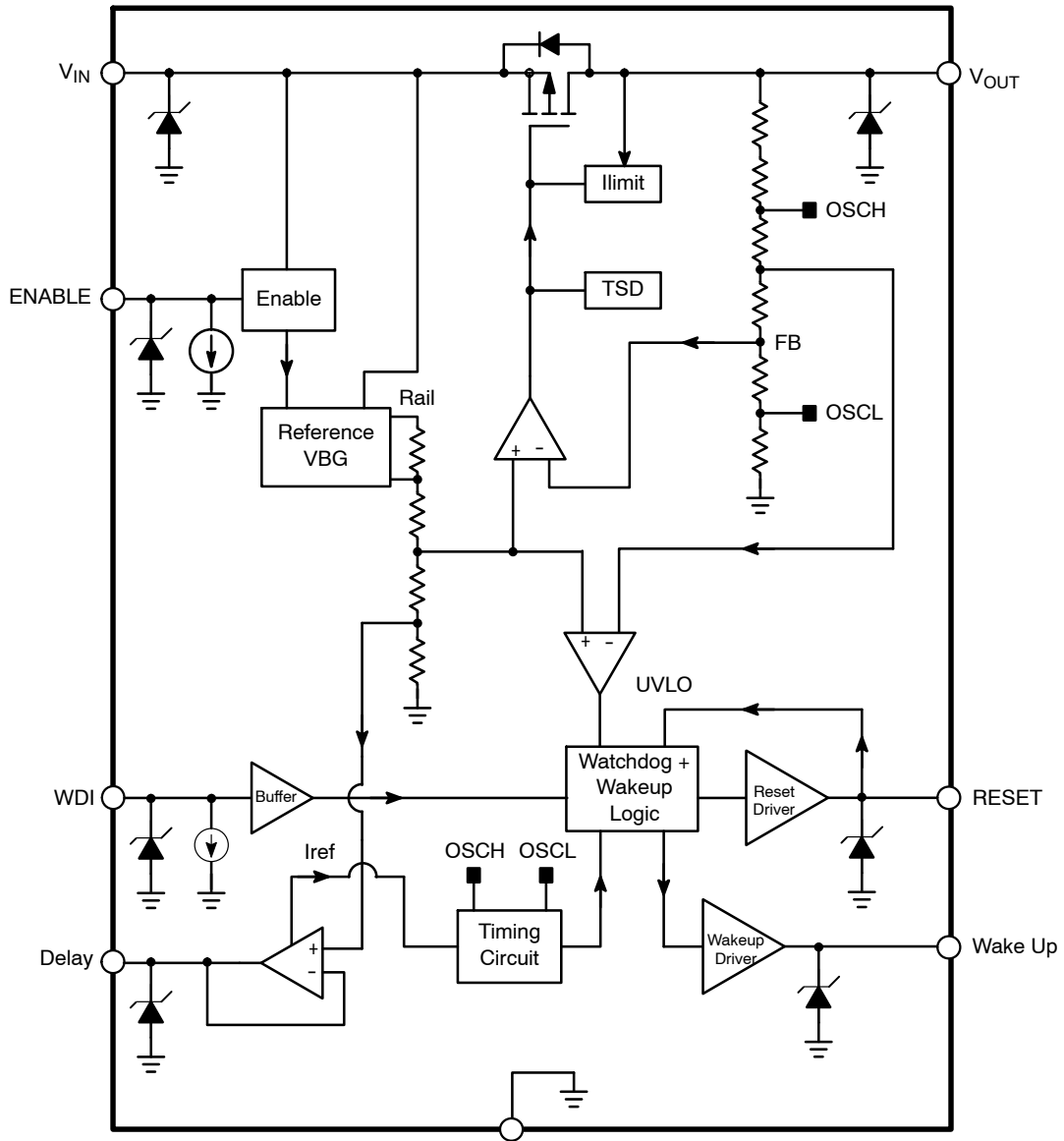

Figure 1. Block Diagram

NCV8518B

MAXIMUM RATINGS

Rating	Symbol	Value	Unit
Input Voltage	V_{IN}	-0.3 to 45	V
ENABLE Voltage (ENABLE may be connected to V_{IN} through an external 20k resistor without damage)	V_{ENABLE}	-0.3 to 16	V
Output Voltage	V_{OUT}	-0.3 to +7.0	V
RESET Voltage	V_{RESET}	0 V to V_{OUT}	V
RESET Current (RESET may be incidentally shorted either to V_{OUT} or to GND without damage)	I_{RESET}	Internally Limited	mA
ESD Susceptibility (Human Body Model)	-	2.0	kV
Logic Inputs/Outputs (Reset, WDI, Wake Up, Delay)	-	-0.3 to +7.0	V
Operating Junction Temperature	T_J	-40 to 150	°C
Storage Temperature Range	T_S	-55 to +150	°C
Moisture Sensitivity Level SOIC-16 EP (Case 751R) SOIC-8 EP (Case 751AC)	MSL	1 2	
Lead Temperature Soldering: Reflow Leaded Part 60-150 sec above 183°C, 30 sec max at peak Lead-Free Part 60-150 sec above 217°C, 40 sec max at peak	- -	240 peak 265 peak	°C °C

Stresses exceeding Maximum Ratings may damage the device. Maximum Ratings are stress ratings only. Functional operation above the Recommended Operating Conditions is not implied. Extended exposure to stresses above the Recommended Operating Conditions may affect device reliability.

THERMAL CHARACTERISTICS

Parameter	Board/Mounting Conditions Typical Value		Unit
SO-8 Exposed Pad Package			
	100 sq. mm spreader board (Note 1)	1 sq. inch spreader board (Note 2)	
Junction to case top (Ψ_{JT})	14	14	°C/W
Junction to lead1 (Ψ_{JL1})	36	26	°C/W
Junction to board (Ψ_{JB}) (Note 3)	15	14	°C/W
Junction to ambient (θ_{JA})	126	80	°C/W
SO-16 Exposed Pad Package			
	100 sq. mm spreader board (Note 1)	1 sq. inch spreader board (Note 2)	
Junction to case top (Ψ_{JT})	20	20	°C/W
Junction to lead1 (Ψ_{JL1})	41	26	°C/W
Junction to board (Ψ_{JB}) (Note 3)	12	12	°C/W
Junction to ambient (θ_{JA})	113	70	°C/W

Specific notes on thermal characterization conditions:

All boards are 0.062" thick FR4, 3" square, with varying amounts of copper heat spreader, in still air (free convection) conditions. Numerical values are derived from an axisymmetric finite-element model where active die area, total die area, flag area, pad area, and board area are equated to the actual corresponding areas.

- 1 oz copper, 100 mm² (0.155 in²) spreader area (includes exposed pad).
- 1 oz copper, 645 mm² (1 in²) spreader area (includes exposed pad).
- "board" is defined as center of exposed pad soldered to board; this is the recommended number to be used for thermal calculations, as it best represents the primary heat flow path and is least sensitive to board and ambient properties.

NCV8518B

ELECTRICAL CHARACTERISTICS ($-40^{\circ}\text{C} \leq T_J \leq 150^{\circ}\text{C}$; $6.0\text{ V} \leq V_{\text{IN}} \leq 28\text{ V}$, $100\ \mu\text{A} \leq I_{\text{OUT}} \leq 150\text{ mA}$, $C_2 = 1.0\ \mu\text{F}$, $R_{\text{Delay}} = 60\text{ k}$; unless otherwise specified.)

Characteristic	Symbol	Min	Typ	Max	Unit
Output					
Output Voltage	V_{OUT}	4.9 -2%	5.00	5.10 +2%	V
Dropout Voltage ($V_{\text{IN}} - V_{\text{OUT}}$, $I_{\text{OUT}} = 150\text{ mA}$) (Note 4)	V_{DO}	-	425	750	mV
Load Regulation ($V_{\text{IN}} = 13.5\text{ V}$, $100\ \mu\text{A} \leq I_{\text{OUT}} \leq 150\text{ mA}$)	Reg_{load}	-	5.0	30	mV
Line Regulation ($6.0\text{ V} \leq V_{\text{IN}} \leq 28\text{ V}$, $I_{\text{OUT}} = 5.0\text{ mA}$)	Reg_{line}	-	5.0	20	mV
Current Limit	I_{lim}	255	400	-	mA
Thermal Shutdown (Guaranteed by Design)	T_{Jmax}	150	180	210	$^{\circ}\text{C}$
Quiescent Current ($V_{\text{IN}} = 13.5\text{ V}$, $I_{\text{OUT}} = 100\ \mu\text{A}$, 150 mA , $\text{ENABLE} = 2.0\text{ V}$) ($\text{ENABLE} = 0\text{ V}$, $T_A = +125^{\circ}\text{C}$)	I_{Q}	- -	100 -	150 1.0	μA

RESET

Threshold Voltage 	-	4.50	4.65	4.75	V
Output Low ($R_{\text{LOAD}} = 10\text{ k}$ to V_{OUT} , $V_{\text{OUT}} = 1.0\text{ V}$)	-	-	0.2	0.4	V
Output High ($R_{\text{LOAD}} = 10\text{ k}$ to GND)	-	$V_{\text{OUT}} - 0.4$	$V_{\text{OUT}} - 0.2$	-	V
Power On Reset Delay Time ($V_{\text{IN}} = 13.5\text{ V}$, $R_{\text{Delay}} = 60\text{ k}$, $I_{\text{OUT}} = 5.0\text{ mA}$) ($V_{\text{IN}} = 13.5\text{ V}$, $R_{\text{Delay}} = 120\text{ k}$, $I_{\text{OUT}} = 5.0\text{ mA}$) $V_{\text{IN}} = 13.5\text{ V}$, $R_{\text{Delay}} = 500\text{ k}$, $I_{\text{OUT}} = 5.0\text{ mA}$)	t_{D}	2.0 - -	3.0 6.0 25	4.0 - -	ms
Reset Reaction Time	T_{rr}	-	20	-	μs
Input and ENABLE Transient Rejection (Note 6)	dV/dt	1.0	-	-	$\text{V}/\mu\text{s}$

Watchdog Input

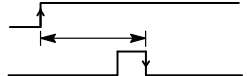
Threshold	WDI_{high}	30	50	70	$\%V_{\text{OUT}}$
Hysteresis (Guaranteed by design) 	WDI_{hys}	25	100	-	mV
Input Current ($\text{WDI} = 6.0\text{ V}$)	-	-	0.1	2.0	μA
Wake Up Rising Edge to WDI Falling Edge Delay 	-	5.0	-	-	μs

ENABLE (Note 5)

Input Threshold Logic Low Logic High	$V_{\text{th(EN)}}$	- 2.0	- -	0.8 -	V
Input Current ($\text{ENABLE} = 2.0\text{ V}$)	-	-	3.0	10	μA

4. Measured when the output voltage has dropped 2% from the nominal value.
5. If ENABLE is connected to V_{IN} , a $20\text{ k}\Omega$ resistor must be placed in series.
6. Slew rates in excess of this limit may cause RESET to change state.

NCV8518B

ELECTRICAL CHARACTERISTICS (continued) ($-40^{\circ}\text{C} \leq T_J \leq 150^{\circ}\text{C}$; $6.0\text{ V} \leq V_{\text{IN}} \leq 28\text{ V}$, $100\ \mu\text{A} \leq I_{\text{OUT}} \leq 150\text{ mA}$, $C_2 = 1.0\ \mu\text{F}$, $R_{\text{Delay}} = 60\text{ k}$; unless otherwise specified.)

Characteristic	Symbol	Min	Typ	Max	Unit
Wake Up Output ($V_{\text{IN}} = 14\text{ V}$, $I_{\text{OUT}} = 5.0\text{ mA}$)					
Wake Up Period ($R_{\text{DELAY}} = 60\text{ k}$) ($R_{\text{DELAY}} = 120\text{ k}$) ($R_{\text{DELAY}} = 500\text{ k}$)	-	18 - -	25 50 208	32 - -	ms
Wake Up Duty Cycle Nominal	-	45	50	55	%
RESET HIGH to Wake Up Rising Delay Time ($R_{\text{DELAY}} = 60\text{ k}$) 50% RESET Rising Edge to 50% Wake Up Edge ($R_{\text{DELAY}} = 120\text{ k}$) ($R_{\text{DELAY}} = 500\text{ k}$)	-	9.0 - -	12.5 25 104	16 - -	ms
Wake Up Response to Watchdog Input 50% WDI Falling Edge to 50% Wake Up Falling Edge	-	-	0.1	5.0	μs
Wake Up Response to RESET 50% RESET Falling Edge to 50% Wake Up Falling Edge ($V_{\text{OUT}} = 5.0\text{ V} \rightarrow 4.5\text{ V}$)	-	-	0.1	5.0	μs
Output Low ($R_{\text{LOAD}} = 10\text{ k}$)	-	-	0.2	0.4	V
Output High ($R_{\text{LOAD}} = 10\text{ k}$)	-	$V_{\text{OUT}} - 0.5$	$V_{\text{OUT}} - 0.25$	-	V
Delay					
Output Voltage ($R_{\text{DELAY}} = 60\text{ k}, 120\text{ k}, 500\text{ k}$)	-	-	0.48	-	V

DEFINITION OF TERMS

Dropout Voltage: The input-to-output voltage differential at which the circuit ceases to regulate against further reduction in input voltage. Measured when the output voltage has dropped 100 mV from the nominal value obtained at 14 V input, dropout voltage is dependent upon load current and junction temperature.

Input Voltage: The DC voltage applied to the input terminals with respect to ground.

Line Regulation: The change in output voltage for a change in the input voltage. The measurement is made under conditions of low dissipation or by using pulse techniques such that the average chip temperature is not significantly affected.

Load Regulation: The change in output voltage for a change in load current at constant chip temperature.

Quiescent Current: The part of the positive input current that does not contribute to the positive load current. The regulator ground lead current with no load.

Current Limit: Peak current that can be delivered to the output.

TYPICAL PERFORMANCE CHARACTERISTICS

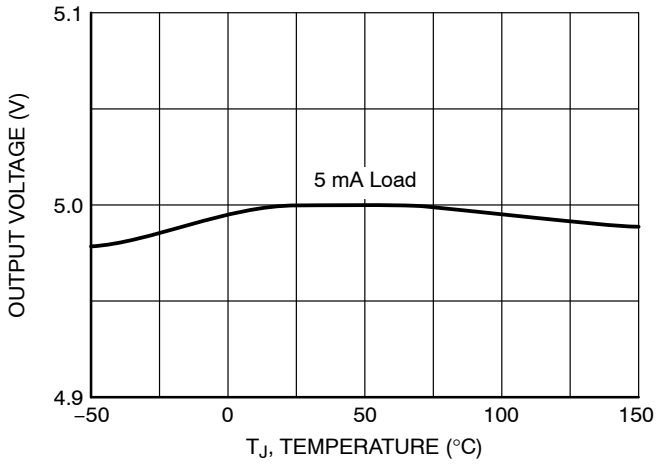

Figure 5. Output Voltage vs. Temperature

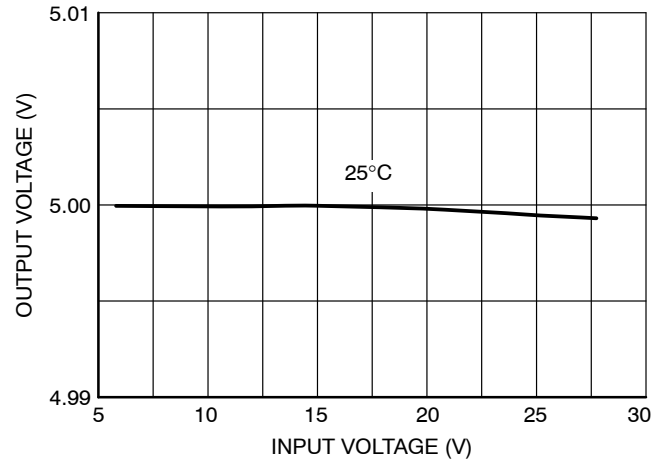

Figure 6. Output Voltage vs. Input Voltage

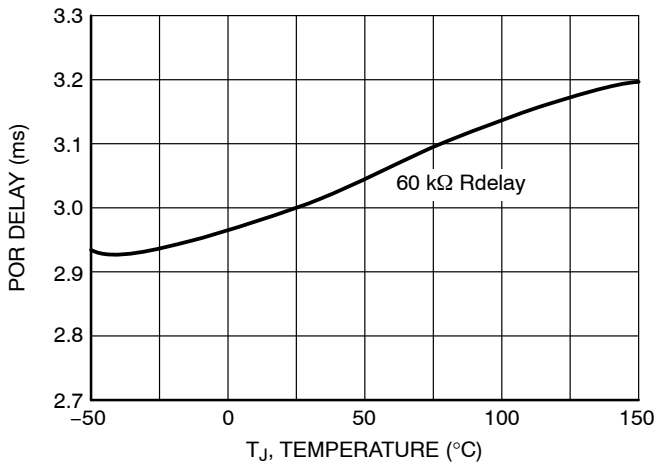

Figure 7. POR Delay vs. Temperature, 60 kΩ Rdelay

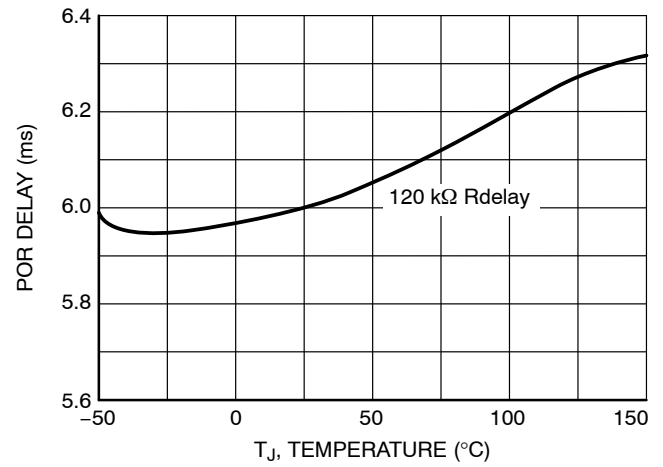

Figure 8. POR Delay vs. Temperature, 120 kΩ Rdelay

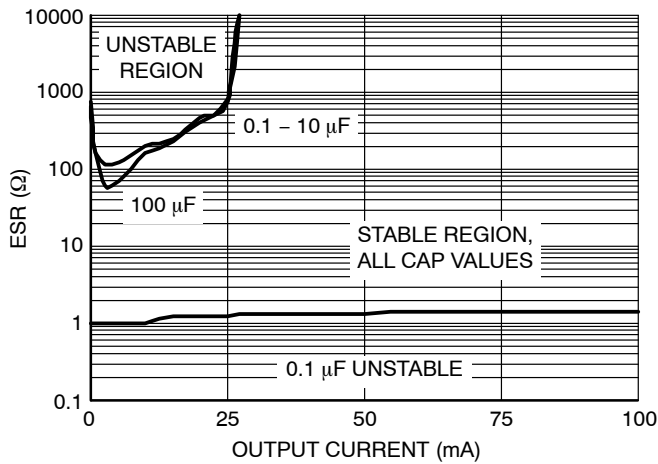

Figure 9. Stability Region of Capacitive ESR vs. Output Current

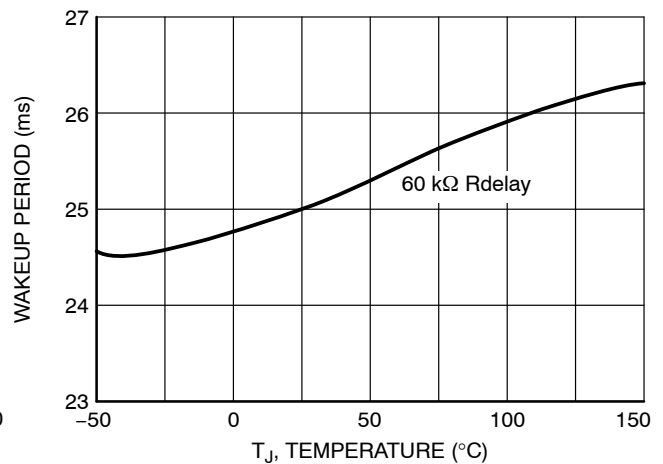

Figure 10. Wakeup Period vs. Temperature

TYPICAL PERFORMANCE CHARACTERISTICS

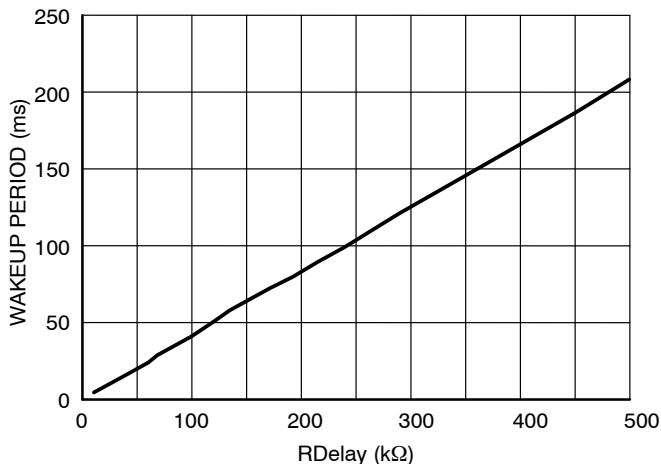

Figure 11. Wakeup Period vs. RDelay

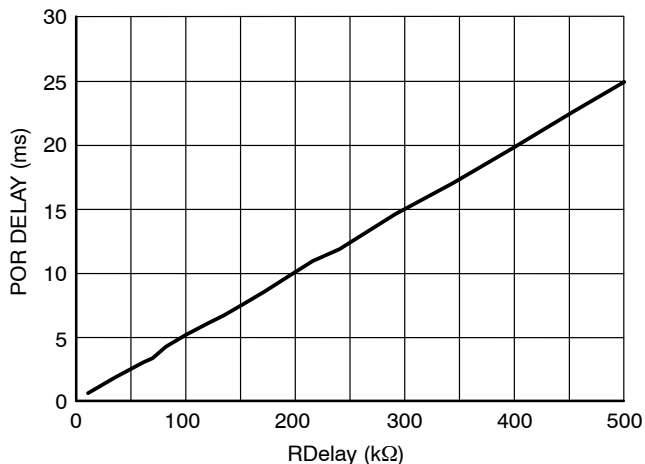

Figure 12. POR Delay vs. RDelay

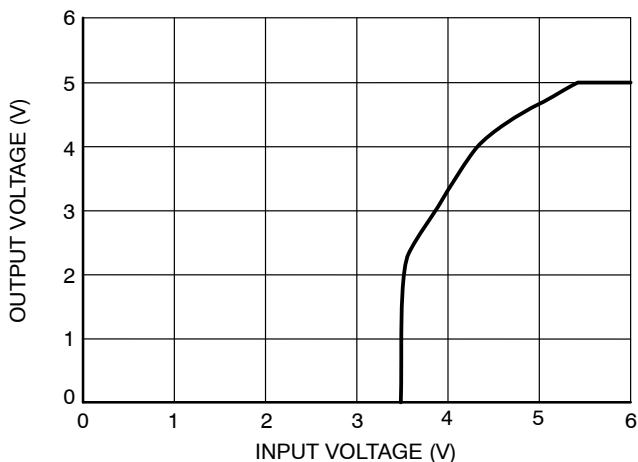

Figure 13. Output Voltage vs. Input Voltage, 5 mA Load

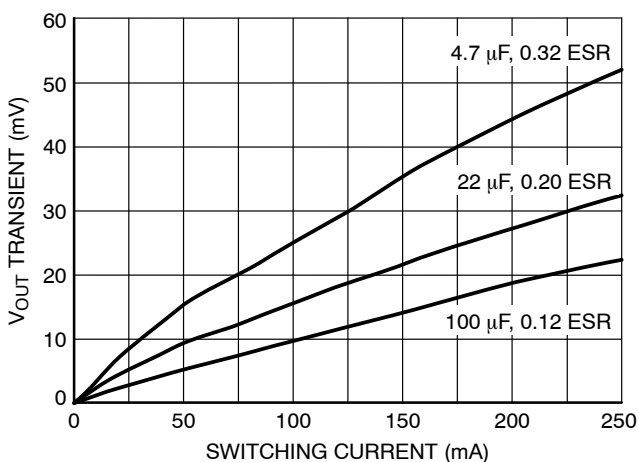

Figure 14. Load Transient Response

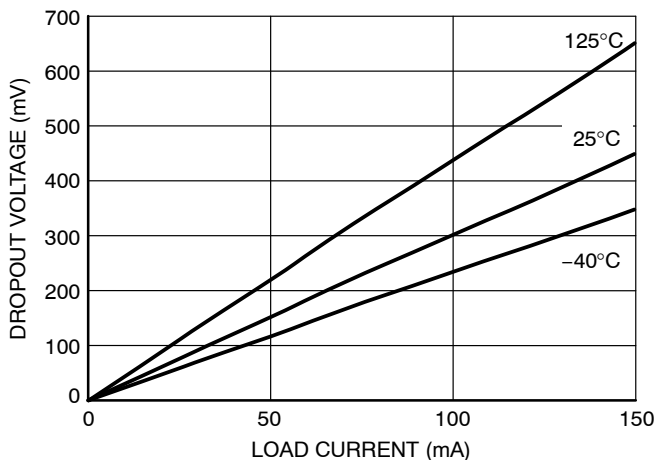

Figure 15. Dropout Voltage vs. Output Current

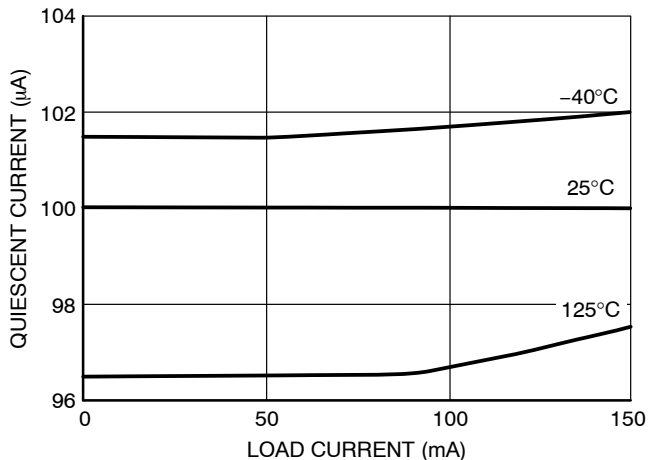

Figure 16. Quiescent Current vs. Output Current

OPERATING DESCRIPTION

General

The NCV8518B is a precision micropower voltage regulator featuring low quiescent current (100 μ A typical at 250 mA load) and low dropout voltage (450 mV typical at 150 mA). Integrated microprocessor control functions include Watchdog, Wakeup and $\overline{\text{RESET}}$. An Enable input is provided for logic level control of the regulator state. The combination of low quiescent current and comprehensive microprocessor interface functions make the NCV8518B ideal for use in both battery operated and automotive applications.

The NCV8518B is internally protected against short circuit and thermal runaway conditions. No external components are required to engage these protective mechanisms. The device continues to operate through 45 volt input transients, an important consideration in automotive environments.

Wakeup and Watchdog

To reduce battery drain, a microprocessor or microcontroller can transition to a low current consumption (“sleep”) mode when code execution is suspended or complete. The NCV8518B Wakeup signal is generated and output periodically to interrupt sleep mode. The nominal Wakeup output is a 5 volt square wave (generated from VOUT) with a duty cycle of 50%, at a frequency determined by external timing resistor R_{DELAY} . In response to the rising edge of the Wakeup signal, the microprocessor will subsequently output a Watchdog pulse and check its inputs to decide if it should resume normal operation or remain in sleep mode.

The NCV8518B responds to the falling edge of the Watchdog signal, which it expects at least once during each Wakeup period. When the correct Watchdog signal is received, the Wakeup output is forced low. Other Watchdog pulses received within the same cycle are ignored. The Watchdog circuitry continuously monitors the input Watchdog signal (WDI) from the microprocessor. The absence of a falling edge on the Watchdog input during one Wakeup cycle will cause a Reset pulse to be output at the end of the Wakeup cycle (see Figure 4).

RESET

As output voltage falls, the $\overline{\text{RESET}}$ output will maintain its current state down to $V_{\text{OUT}} = 1$ V. A Reset signal (active low) is asserted for any of four conditions:

1. During power up, $\overline{\text{RESET}}$ is held low until the output voltage is in regulation.
2. During operation, if the output voltage falls below the Reset threshold, $\overline{\text{RESET}}$ switches low, and will remain low until both the output voltage has recovered and the Reset delay timer cycle has completed following that recovery.
3. $\overline{\text{RESET}}$ will switch low if the regulator does not receive a Watchdog input signal within a Wakeup period.
4. Regardless of output voltage, $\overline{\text{RESET}}$ will switch low if the regulator input voltage V_{IN} , falls below a level required to sustain the internal control circuits. The specific voltage is temperature dependent, and is approximately 4.75 V at 20°C.

The Wakeup output is pulled low during a $\overline{\text{RESET}}$ regardless of the cause of the $\overline{\text{RESET}}$. After the $\overline{\text{RESET}}$ returns high, the Wakeup cycle begins again (see Figure 4).

The $\overline{\text{RESET}}$ Delay Time, Wakeup signal frequency and $\overline{\text{RESET}}$ high to Wakeup delay time are all set by one external resistor, R_{Delay} , according to the following equations:

$$\text{Wakeup Period (seconds)} = (4.17 \times 10^{-7}) * R_{\text{DELAY}} (\Omega)$$

$$\overline{\text{RESET}} \text{ Delay Time (seconds)} = (5.21 \times 10^{-8}) * R_{\text{DELAY}} (\Omega)$$

$$\overline{\text{RESET}} \text{ High to Wakeup Delay Time (seconds)} = (2.08 \times 10^{-7}) * R_{\text{DELAY}} (\Omega)$$

The voltage present at the Delay pin is a buffered bandgap voltage (~1.25 V) and can be used as a reference for an external tracking regulator.

Enable

This is a standard TTL and CMOS logic compatible input that can be used to turn the regulator on or off. Logic high enables the regulator; logic low disables it (also called *shutdown*). In the disabled/shutdown state, the pass transistor is off and total quiescent current is less than 1 μ A.

NCV8518B

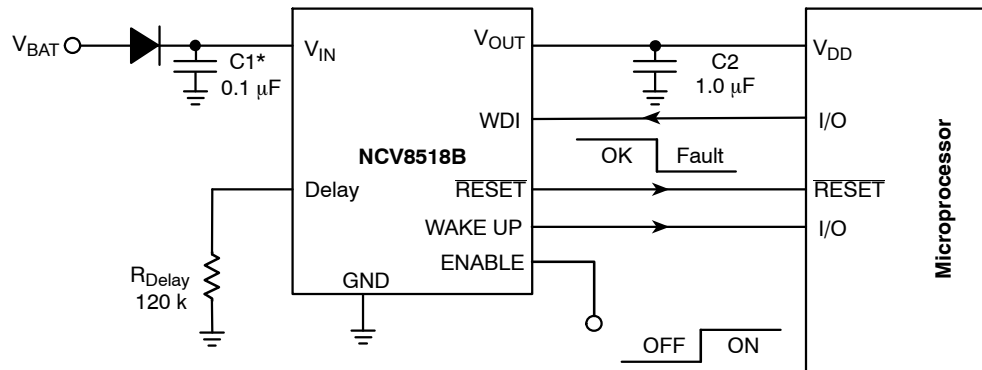

* $C1$ required if regulator is located far from power supply filter. If extremely fast input voltage transients are expected then appropriate input filter must be used. The filter can be composed of several capacitors in parallel.

Figure 17. Application Circuit

NCV8518B

PACKAGE DIMENSIONS

SOIC-8 EP
D SUFFIX
CASE 751AC-01
ISSUE B

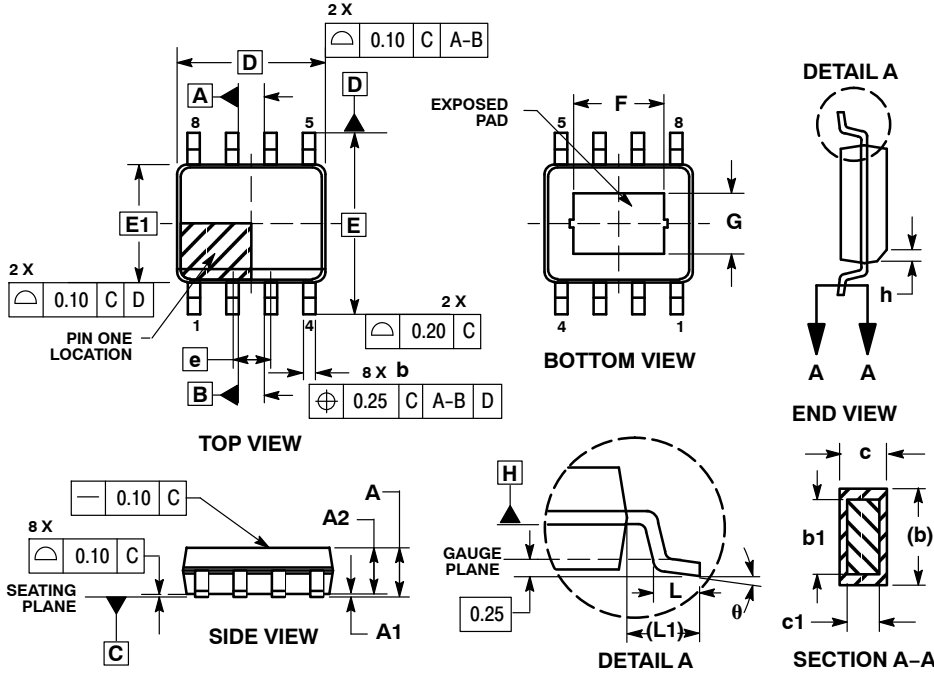

- NOTES:
1. DIMENSIONS AND TOLERANCING PER ASME Y14.5M, 1994.
 2. DIMENSIONS IN MILLIMETERS (ANGLES IN DEGREES).
 3. DIMENSION b DOES NOT INCLUDE DAMBAR PROTRUSION. ALLOWABLE DAMBAR PROTRUSION SHALL BE 0.08 MM TOTAL IN EXCESS OF THE "b" DIMENSION AT MAXIMUM MATERIAL CONDITION.
 4. DATUMS A AND B TO BE DETERMINED AT DATUM PLANE H.

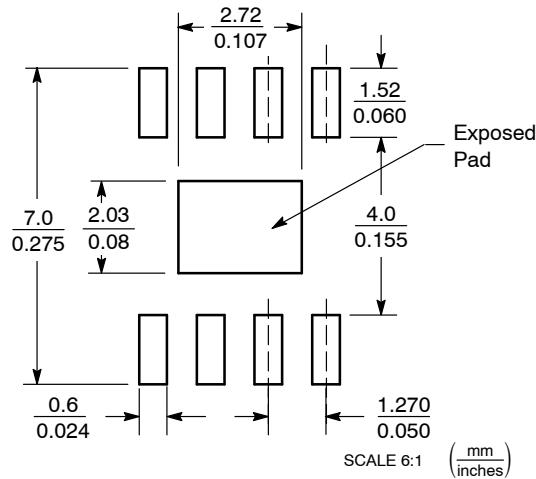

SOLDERING FOOTPRINT*





*For additional information on our Pb-Free strategy and soldering details, please download the ON Semiconductor Soldering and Mounting Techniques Reference Manual, SOLDERRM/D.

Looking for pricing, stock, or lifecycle information?

Click below to explore more details on WIN SOURCE:

-  [View NCV8518BPWR2G on WIN SOURCE](#)
-  [ON Semiconductor Information](#)

Optimize Your Supply Chain with WIN SOURCE Solutions

-  Global Sourcing Solution
-  Obsolete Management
-  Cost Control Management
-  Shortage Management
-  Alternative Solution
-  Excess Inventory Management