



**THE DATASHEET OF
SP7805V2-L/TR**



3-Terminal Positive Regulators

Features

- Output Current up to 1.0A
- Fixed Output Voltages of 5V and 12V
- Output Voltage Tolerances of $\pm 5\%$ over the Full Temperature Range
- Internal Short Circuit Current-limiting
- Internal Thermal Overload Protection
- Available in Lead Free, RoHS Compliant Packages

TO-220 Package

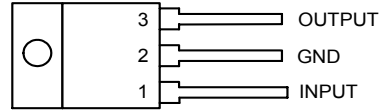

Applications

- Consumer Electronics
- Microprocessor Power Supply
- Mother Board I/O Power Supply

General Description

The SP78XX series are monolithic integrated circuits designed as fixed-voltage regulators for a wide variety of applications including local, on-card regulation.

This series of regulators are complete with internal current limiting, thermal shutdown protection, and safe-area compensation which make them virtually immune from output overload. If adequate heat sinking is provided, these regulators can deliver output currents up to 1.0A.

The SP78XX series are available in two standard plastic packages: TO-220 and TO-252.

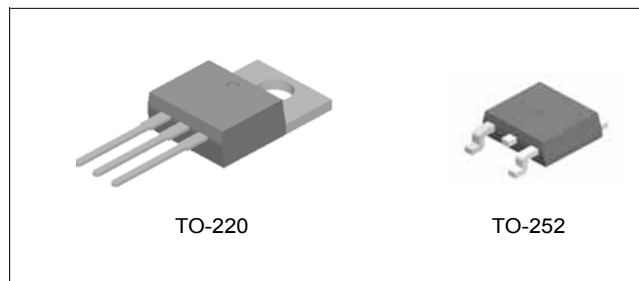

Figure 1. Package Types of SP78XX

Pin Configuration

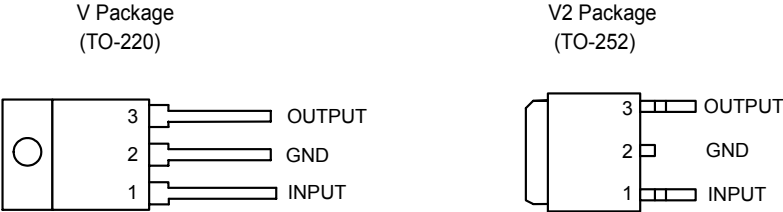

Figure 2. Pin Configuration of SP78XX (Top View)

Pin Description

Pin Number	Pin Name	Function
1	INPUT	Voltage Input
2	GND	Ground
3	OUTPUT	Voltage Output

Functional Block Diagram

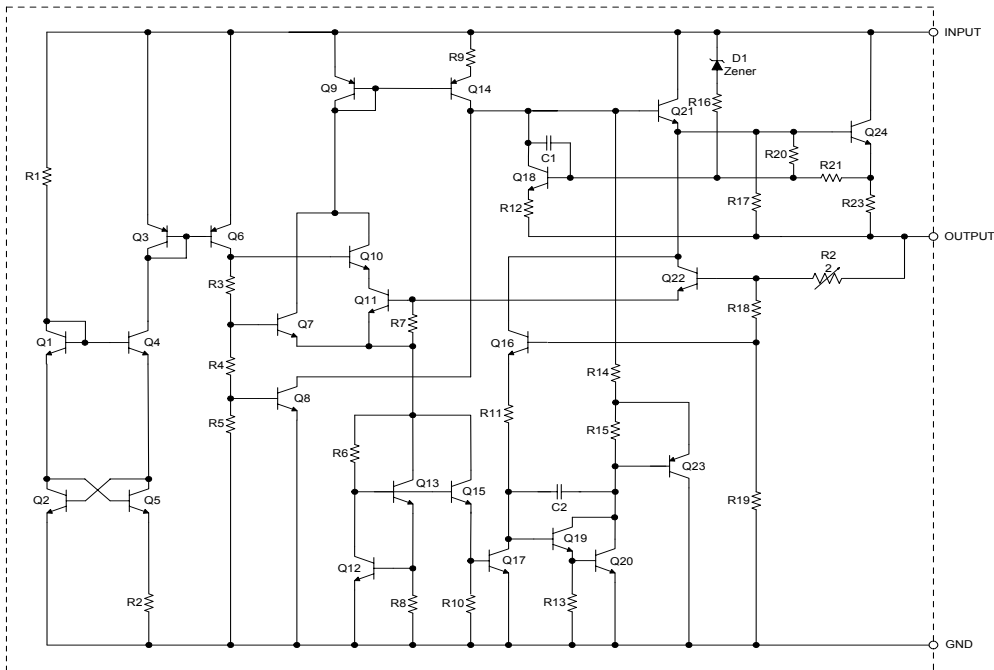

Figure 3. Functional Block Diagram of SP78XX

Absolute Maximum Ratings (Note 1)

Parameter	Symbol	Value	Unit
Input Voltage	V_{IN}	20	V
Lead Temperature (Soldering, 10sec)		300	°C
Power Dissipation	P_D	Internally Limited	
Storage Temperature Range	T_{STG}	-65 to 150	°C
ESD (Machine Model)	ESD	500	V

Note 1: Stresses greater than those listed under "Absolute Maximum Ratings" may cause permanent damage to the device. These are stress ratings only, and functional operation of the device at these or any other conditions beyond those indicated under "Recommended Operating Conditions" is not implied. Exposure to "Absolute Maximum Ratings" for extended periods may affect device reliability.

Recommended Operating Conditions

Parameter	Symbol	Min	Max	Unit
Supply Voltage	V_{CC}	7.5	18	V
Operating Junction Temperature Range	T_J	-40	125	°C

Electrical Characteristics

SP7805 ($V_I=10V$, $I_O=1A$, $T_J=-40$ to 125 °C, unless otherwise specified.)

Parameter	Symbol	Conditions	Min	Typ	Max	Unit
Output Voltage	V_O	$T_J=25^\circ\text{C}$	4.9	5.0	5.1	V
		$I_O=5\text{mA}$ to $1A$, $V_I=7.5$ to $15V$, $P_D \leq 15W$	4.8	5.0	5.2	
Line Regulation	V_{RLINE}	$V_I=8V$ to $15V$, $I_O=1A$, $T_J=25^\circ\text{C}$		1	20	mV
Load Regulation	V_{RLOAD}	$V_I=10V$, $I_O=5\text{mA}$ to $1A$, $T_J=25^\circ\text{C}$		10	35	mV
Quiescent Current	I_Q	$V_I=10V$		3.2	6.0	mA
Quiescent Current Change	ΔI_Q	$V_I=8V$ to $15V$, $I_O=500\text{mA}$, $T_J=25^\circ\text{C}$		0.3	0.8	mA
		$I_O=5\text{mA}$ to $1A$, $T_J=25^\circ\text{C}$		0.08	0.5	
Ripple Rejection	$\Delta V_I/\Delta V_O$	$V_I=8V$ to $15V$, $f=120\text{Hz}$, $I_O=300\text{mA}$	63	73		dB
Dropout Voltage	V_I-V_O	$\Delta V_O/V_O=1\%$, $I_O=1A$, $T_J=25^\circ\text{C}$		2.0		V
Output Noise Voltage	N_O	$f=10\text{Hz}$ to 100KHz , $T_A=25^\circ\text{C}$		10		$\mu\text{V}/V_O$
Output Resistance	R_O	$f=1.0\text{kHz}$		10		$\text{m}\Omega$
Short Circuit Current	I_{PK}	$V_I=15V$, $T_A=25^\circ\text{C}$		0.8		A
Peak Output Current	I_{MAX}	$V_I=10V$, $T_J=25^\circ\text{C}$		2.2		A
Output Voltage Drift	$\Delta V_O/\Delta T$			-0.3		$\text{mV}/^\circ\text{C}$

Electrical Characteristics

SP7812 ($V_I=17V$, $I_O=1A$, $T_J=-40$ to 125 °C, unless otherwise specified.)

Parameter	Symbol	Condition	Min	Typ	Max	Unit
Output Voltage	V_O	$T_J=25^\circ\text{C}$	11.5	12	12.5	V
		$I_O=5\text{mA}$ to $1A$, $V_I=14.8$ to $17V$, $P_D \leq 15W$	11.4	12	12.6	
Line Regulation	V_{RLINE}	$V_I=14.5$ to $18V$, $I_O=1A$, $T_J=25^\circ\text{C}$		2.2	20	mV
Load Regulation	V_{RLOAD}	$V_I=17V$, $I_O=5\text{mA}$ to $1A$, $T_J=25^\circ\text{C}$		8.1	60	mV
Quiescent Current	I_Q	$V_I=17V$		3.4	6.5	mA
Quiescent Current Change	ΔI_Q	$V_I=14.5$ to $17V$, $I_O=1A$, $T_J=25^\circ\text{C}$			0.7	mA
		$I_O=5.0\text{mA}$ to $1A$, $T_J=25^\circ\text{C}$			0.5	
Ripple Rejection	$\Delta V_I/\Delta V_O$	$V_I=15V$ to $17V$, $f=120\text{Hz}$, $I_O=300\text{mA}$	55	60		dB
Dropout Voltage	V_I-V_O	$\Delta V_O/V_O=1\%$, $I_O=1A$, $T_A=25^\circ\text{C}$		2.0		V
Output Noise Voltage	N_O	$f=10\text{Hz}$ to 100KHz , $T_A=25^\circ\text{C}$		10		$\mu\text{V}/V_O$
Output Resistance	R_O	$f=1.0\text{KHz}$		13		$\text{m}\Omega$
Short Circuit Current	I_{PK}	$V_I=15V$, $T_A=25^\circ\text{C}$		0.8		A
Peak Output Current	I_{MAX}	$V_I=17V$, $T_J=25^\circ\text{C}$		2.2		A
Output Voltage Drift	$\Delta V_O/\Delta T$			-0.8		$\text{mV}/^\circ\text{C}$

Typical Performance Characteristics

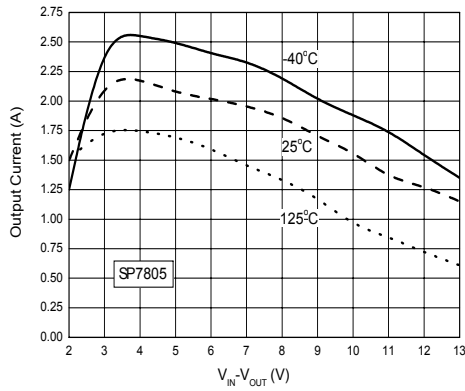

Figure 4. Peak Output Current vs. Input / Output Differential Voltage

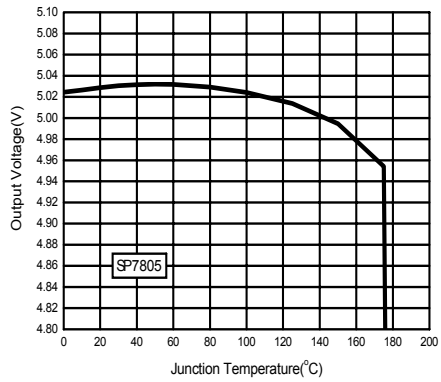

Figure 5. Output Voltage vs. Junction Temperature

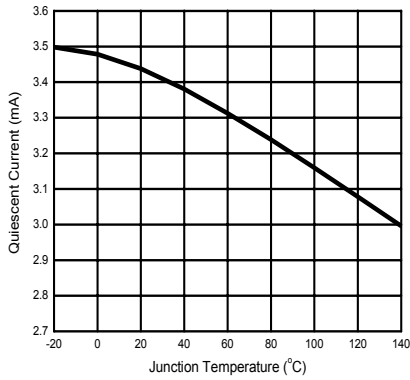

Figure 6. Quiescent Current vs. Junction Temperature

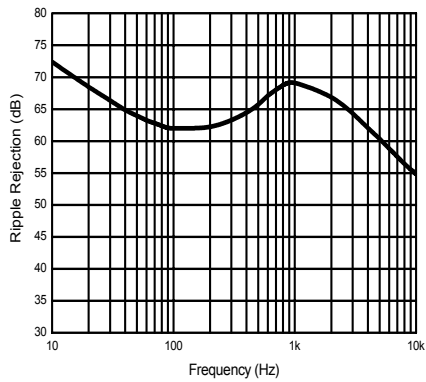

Figure 7. Ripple Rejection vs. Frequency

Typical Application

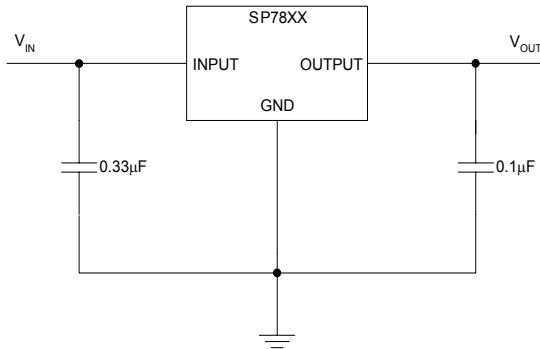
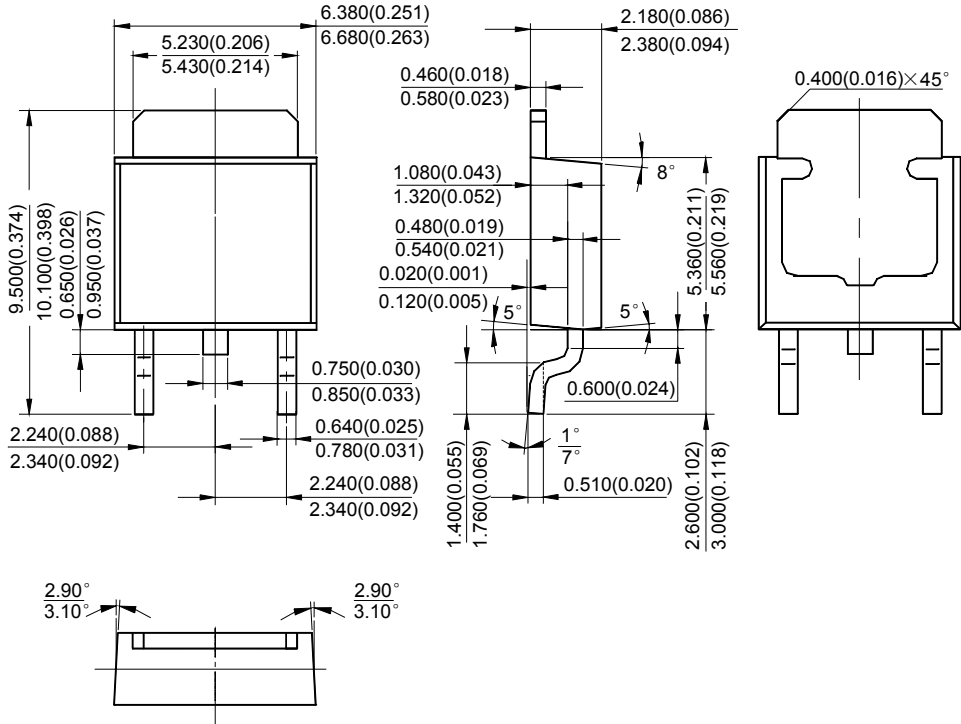

Figure 8. Fixed Output Regulator of SP78XX

Mechanical Dimension (Continued)

TO-252

Unit: mm(inch)



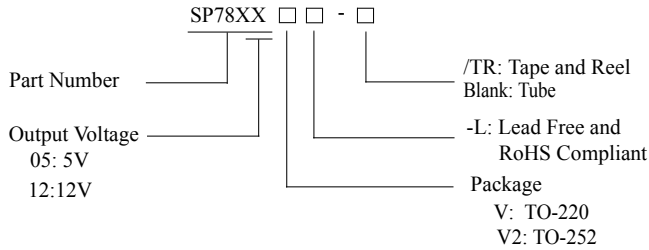

Sipex Corporation's Pb-free products, as designated with "-L" suffix in the part number, are RoHS compliant.

Part Number	Temperature Range	Voltage Tolerance	Output Voltage	Package	Pin Count	Packing Type
SP7805V-L	-40°C to +125°C	±5%	5V	TO-220	3	50/TUBE
SP7812V-L	-40°C to +125°C	±5%	12V	TO-220	3	50/TUBE
SP7805V2-L/TR	-40°C to +125°C	±5%	5V	TO-252	3	2,500/TR
SP7812V2-L/TR	-40°C to +125°C	±5%	12V	TO-252	3	2,500/TR



Sipex Corporation



**Headquarters and
Sales Office**

233 South Hillview Drive
Milpitas, CA 95035
TEL: (408) 934-7500
FAX: (408) 935-7600







Sipex Corporation reserves the right to make changes to any products described herein. Sipex does not assume any liability arising out of the application or use of any product or circuit described herein; neither does it convey any license under its patent rights nor the rights of others.

Looking for pricing, stock, or lifecycle information?

Click below to explore more details on WIN SOURCE:

-  [View SP7805V2-L/TR on WIN SOURCE](#)
-  [Exar Corporation Information](#)

Optimize Your Supply Chain with WIN SOURCE Solutions

-  Global Sourcing Solution
-  Obsolete Management
-  Cost Control Management
-  Shortage Management
-  Alternative Solution
-  Excess Inventory Management