



**THE DATASHEET OF
LM2854MH-500/NOPB**



LM2854 4-A 500-kHz / 1-MHz Synchronous Buck Regulator

1 Features

- Input Voltage Range of 2.95 V to 5.5 V
- Maximum Load Current of 4 A
- Wide Bandwidth Voltage Mode Control Loop, Partial Internal Compensation
- Fixed Switching Frequency of 500 kHz or 1 MHz
- 35-mΩ Integrated MOSFET Switches
- Adjustable Output Voltage Down to 0.8 V
- Optimized Reference Voltage Initial Accuracy and Temperature Drift
- External Soft-Start Control With Tracking Capability
- Enable Pin With Hysteresis
- Low Standby Current of 230 μA
- Pre-Biased Load Start-up Capability
- Integrated UVLO, OCP, and Thermal Shutdown
- 100% Duty Cycle Capability
- HTSSOP-16 Exposed Pad Package

2 Applications

- Low Voltage POL Regulation from 5-V or 3.3-V Rail
- Local Solution for FPGA/DSP/ASIC/μP Core or I/O Power
- Broadband Networking and Communications Infrastructure
- Portable Computing

3 Description

The LM2854 PowerWise™ buck regulator is a 500-kHz or 1-MHz step-down switching voltage regulator capable of driving up to a 4-A load with exceptional power conversion efficiency, line and load regulation, and output accuracy. The LM2854 can accept an input voltage rail between 2.95 V and 5.5 V, and deliver an adjustable and highly accurate output voltage as low as 0.8 V. Externally established soft-start with a small capacitor facilitates controlled start-up, and the LM2854 is capable of starting gracefully into a pre-biased output voltage. Partial internal compensation reduces the number of external passive components and PC board space typically necessary in a voltage mode buck converter application, yet preserving flexibility to deal with ceramic and/or electrolytic based load capacitors. Lossless cycle-by-cycle peak current limit is used to protect the load from an overcurrent or short-circuit fault, and an enable comparator simplifies sequencing applications. The LM2854 is available in an exposed pad HTSSOP-16 package that enhances the thermal performance of the regulator.

Device Information⁽¹⁾

PART NUMBER	PACKAGE	BODY SIZE (NOM)
LM2854	HTSSOP (16)	4.40 mm x 5.00 mm

(1) For all available packages, see the orderable addendum at the end of the data sheet.

Typical Application Circuit

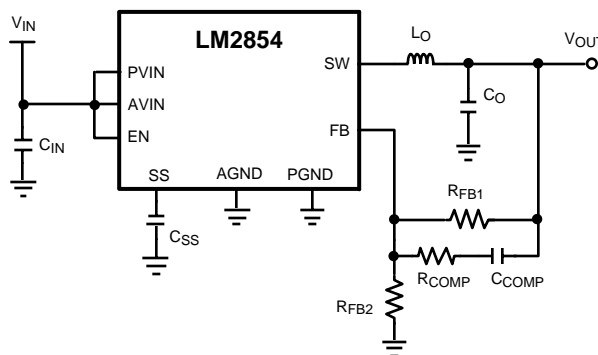

Table of Contents

1 Features	1	7.3 Feature Description.....	9
2 Applications	1	7.4 Device Functional Modes.....	11
3 Description	1	8 Application and Implementation	12
4 Revision History	2	8.1 Application Information.....	12
5 Pin Configuration and Functions	3	8.2 Typical Application	12
6 Specifications	4	9 Power Supply Recommendations	25
6.1 Absolute Maximum Ratings	4	10 Layout	25
6.2 ESD Ratings.....	4	10.1 Layout Guidelines	25
6.3 Recommended Operating Conditions.....	4	10.2 Layout Example	26
6.4 Thermal Information	4	11 Device and Documentation Support	27
6.5 Electrical Characteristics.....	5	11.1 Documentation Support	27
6.6 Typical Characteristics	6	11.2 Trademarks	27
7 Detailed Description	9	11.3 Electrostatic Discharge Caution.....	27
7.1 Overview	9	11.4 Glossary	27
7.2 Functional Block Diagram	9	12 Mechanical, Packaging, and Orderable Information	27

4 Revision History

NOTE: Page numbers for previous revisions may differ from page numbers in the current version.

Changes from Revision C (April 2013) to Revision D

Page

- Added *ESD Ratings* table, *Feature Description* section, *Device Functional Modes*, *Application and Implementation* section, *Power Supply Recommendations* section, *Layout* section, *Device and Documentation Support* section, and *Mechanical, Packaging, and Orderable Information* section. **1**
- Removed Soldering and Infrared values from *Absolute Maximum Ratings*. **4**
- Added thermal information generated using TI standard methodology. **4**

Changes from Revision B (April 2013) to Revision C

Page

- Changed layout of National Data Sheet to TI format

24

Changes from Revision D (January 2016) to Revision E

Page

- Deleted Simple Switcher from *Description* section, and *Detailed Description* section..... **1**

5 Pin Configuration and Functions

**PWP Package
16-Pin HTSSOP
Top View**

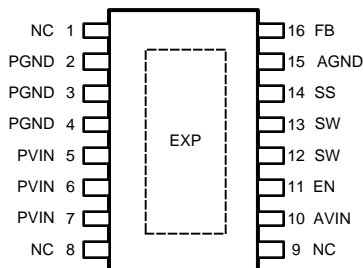

Pin Functions

PIN		I/O	DESCRIPTION
NAME	NO.		
NC	1, 8, 9	—	Reserved for factory use, this pin should be connected to GND to ensure proper operation.
PGND	2, 3, 4	—	Power ground pins for the internal power switches. These pins should be connected together locally at the device and tied to the PC board ground plane.
PVIN	5, 6, 7	—	Input voltage to the power switches inside the device. These pins should be connected together at the device. A low ESR input capacitance should be located as close as possible to these pins.
AVIN	10	—	Analog input voltage supply that generates the internal bias. The UVLO circuit derives its input from this pin also. Thus, if the voltage on AVIN falls below the UVLO threshold, both internal FETs are turned off. TI recommends connecting PVIN to AVIN through a low pass RC filter to minimize the influence of input rail ripple and noise on the analog control circuitry. The series resistor should be 1 Ω and the bypass capacitor should be a X7R ceramic type 0.1 μ F to 1 μ F.
EN	11	I	Active high enable input for the device. Typically, turnon threshold is 1.23 V with 0.15-V hysteresis. An external resistor divider from PVIN can be used to effectively increase the UVLO turnon threshold. If not used, the EN pin should be connected to PVIN.
SW	12, 13	O	Switch node pins. This is the PWM output of the internal MOSFET power switches. These pins should be tied together locally and connected to the filter inductor.
SS	14	I/O	Soft-start control pin. An internal 2- μ A current source charges an external capacitor connected between this pin and AGND to set the output voltage ramp rate during start-up. This pin can also be used to configure the tracking feature.
AGND	15	—	Quiet analog ground for the internal bias circuitry.
FB	16	I	Feedback pin is connected to the inverting input of the voltage loop error amplifier. An 0.8-V bandgap reference is connected to the noninverting input of the error amplifier.
Exposed Pad		—	Exposed metal pad on the underside of the package with a weak electrical connection to PGND. TI recommends connecting this pad to the PC board ground plane in order to improve thermal dissipation.

6 Specifications

6.1 Absolute Maximum Ratings

over operating free-air temperature range (unless otherwise noted) ⁽¹⁾⁽²⁾

	MIN	MAX	UNIT
PVIN, AVIN, SW, EN, FB, SS to GND ⁽³⁾	-0.3	6	V
Power Dissipation	Internally Limited		
Junction Temperature		150	°C
Storage Temperature	-65	150	°C

- (1) Stresses beyond those listed under *Absolute Maximum Ratings* may cause permanent damage to the device. These are stress ratings only, which do not imply functional operation of the device at these or any other conditions beyond those indicated under *Recommended Operating Conditions*. Exposure to absolute-maximum-rated conditions for extended periods may affect device reliability.
- (2) If Military/Aerospace specified devices are required, please contact the Texas Instruments Sales Office/ Distributors for availability and specifications.
- (3) PGND and AGND are electrically connected together on the PC board and the resultant net is termed GND.

6.2 ESD Ratings

	VALUE	UNIT
V _(ESD) Electrostatic discharge Human-body model (HBM), per ANSI/ESDA/JEDEC JS-001 ⁽¹⁾⁽²⁾	±2000	V

- (1) JEDEC document JEP155 states that 500-V HBM allows safe manufacturing with a standard ESD control process.
- (2) The human body model is a 100-pF capacitor discharged through a 1.5-kΩ resistor into each pin. Test method is per JESD22-A114.

6.3 Recommended Operating Conditions

	MIN	MAX	UNIT
PVIN to GND ⁽¹⁾	2.95	5.5	V
AVIN to GND ⁽¹⁾	2.95	5.5	V
Junction Temperature	-40	125	°C

- (1) PGND and AGND are electrically connected together on the PC board and the resultant net is termed GND.

6.4 Thermal Information

THERMAL METRIC ⁽¹⁾		LM2854	UNIT
		PWP (HTSSOP)	
		16 PINS	
R _{θJA}	Junction-to-ambient thermal resistance	38.4	°C/W
R _{θJC(top)}	Junction-to-case (top) thermal resistance	27.6	°C/W
R _{θJB}	Junction-to-board thermal resistance	17.1	°C/W
Ψ _{JT}	Junction-to-top characterization parameter	1.5	°C/W
Ψ _{JB}	Junction-to-board characterization parameter	16.9	°C/W
R _{θJC(bot)}	Junction-to-case (bottom) thermal resistance	1.3	°C/W

- (1) For more information about traditional and new thermal metrics, see the *Semiconductor and IC Package Thermal Metrics* application report, [Semiconductor and IC Package Thermal Metrics](#).

6.5 Electrical Characteristics

All Typical specifications are for $T_J = 25^\circ\text{C}$ only; all Maximum and Minimum limits apply over the operating junction temperature range T_J range of -40°C to 125°C . Minimum and maximum limits are ensured through test, design, or statistical correlation. Typical values represent the most likely parametric norm at $T_J = 25^\circ\text{C}$, and are provided for reference purposes only. $AVIN = PVIN = EN = 5\text{ V}$, unless otherwise indicated in the Test Conditions column.

PARAMETER		TEST CONDITIONS	MIN ⁽¹⁾	TYP ⁽²⁾	MAX ⁽¹⁾	UNIT
SYSTEM PARAMETERS						
V_{REF}	Reference Voltage ⁽³⁾	Measured at the FB pin	0.790	0.8	0.808	V
$\Delta V_{REF}/\Delta AVIN$	Line Regulation ⁽³⁾	$\Delta AVIN = 2.95\text{ V to }5.50\text{ V}$		0.04%	0.6%	
$\Delta V_{REF}/\Delta I_O$	Load Regulation	Normal operation		0.25		mV/A
V_{ON}	UVLO Threshold (AVIN)	Rising		2.6	2.95	V
		Falling hysteresis	25	170	375	mV
$R_{DS(ON)-P}$	PFET On Resistance	$I_{SW} = 4\text{ A}$		35	65	m Ω
$R_{DS(ON)-N}$	NFET On Resistance	$I_{SW} = 4\text{ A}$		34	65	m Ω
I_{SS}	Soft-Start Current			2		μA
I_{CL}	Peak Current Limit Threshold		4.5	6	6.7	A
I_Q	Operating Current	Non-switching		1.7	3	mA
I_{SD}	Shut Down Quiescent Current	$EN = 0\text{ V}$		230	500	μA
PWM SECTION						
f_{SW}	Switching Frequency	1-MHz option	800	1050	1160	kHz
		500-kHz option	400	525	580	kHz
D_{range}	PWM Duty Cycle Range		0%		100%	
ENABLE CONTROL						
V_{IH}	EN Pin Rising Threshold		0.8	1.23	1.65	V
$V_{EN(HYS)}$	EN Pin Hysteresis			150		mV
THERMAL CONTROL						
T_{SD}	T_J for Thermal Shutdown			165		$^\circ\text{C}$
T_{SD-HYS}	Hysteresis for Thermal Shutdown			10		$^\circ\text{C}$

- (1) Min and Max limits are 100% production tested at 25°C . Limits over the operating temperature range are ensured through correlation using Statistical Quality Control (SQC) methods. Limits are used to calculate Average Outgoing Quality Level (AOQL).
- (2) Typical numbers are at 25°C and represent the most likely parametric norm.
- (3) V_{REF} measured in a non-switching, closed-loop configuration.

6.6 Typical Characteristics

Unless otherwise specified, the following conditions apply: $V_{IN} = P_{VIN} = A_{VIN} = E_N = 5$, $T_J = 25^\circ\text{C}$.

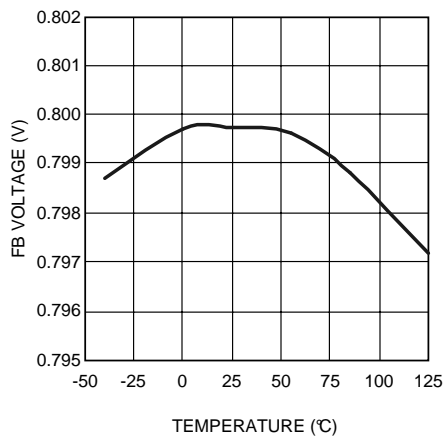

Figure 1. Feedback Voltage vs Temperature

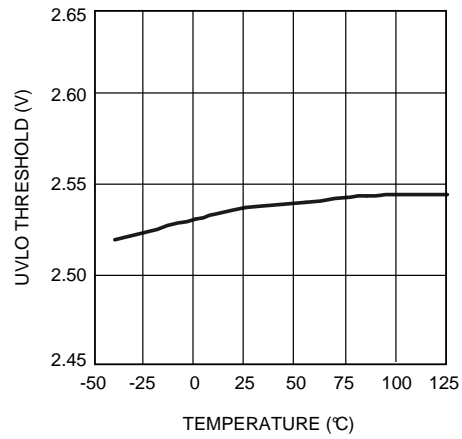

Figure 2. UVLO Threshold vs Temperature

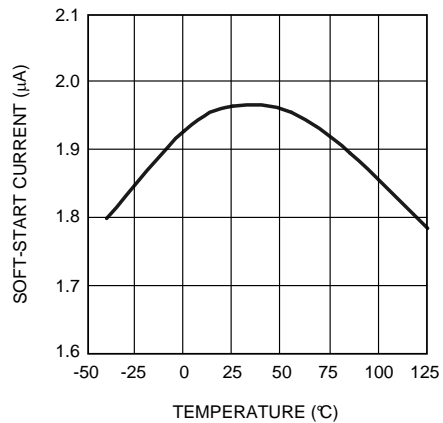

Figure 3. Soft Start Current vs Temperature

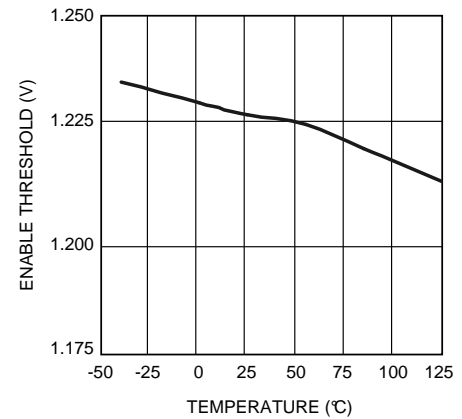

Figure 4. Enable Threshold vs Temperature

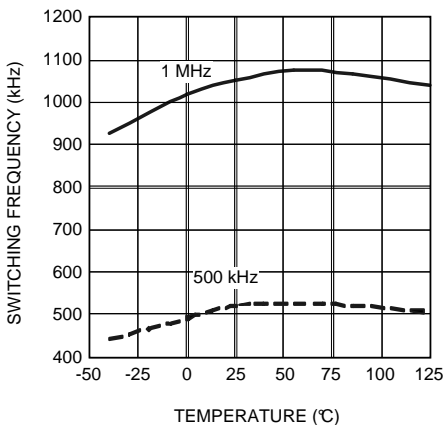

Figure 5. Switching Frequency vs Temperature

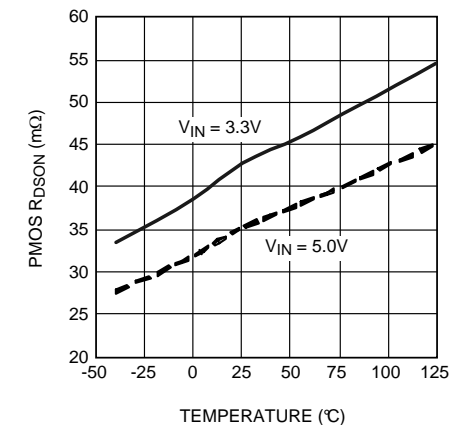

Figure 6. PMOS $R_{DS(ON)}$ vs Temperature

Typical Characteristics (continued)

Unless otherwise specified, the following conditions apply: $V_{IN} = P_{VIN} = A_{VIN} = EN = 5$, $T_J = 25^\circ\text{C}$.

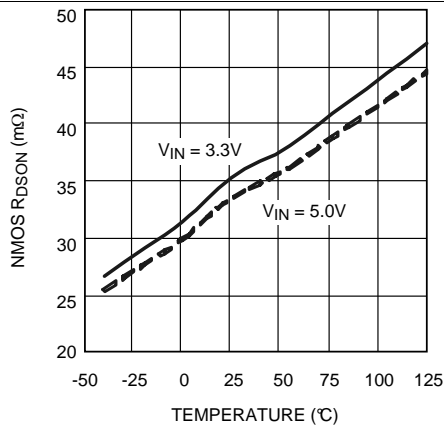

Figure 7. NMOS $R_{DS(ON)}$ vs Temperature

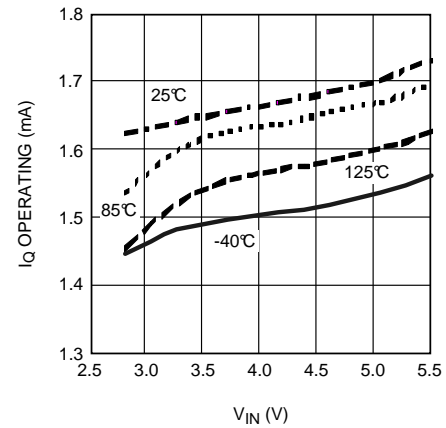

Figure 8. I_Q (operating) vs V_{IN} and Temperature

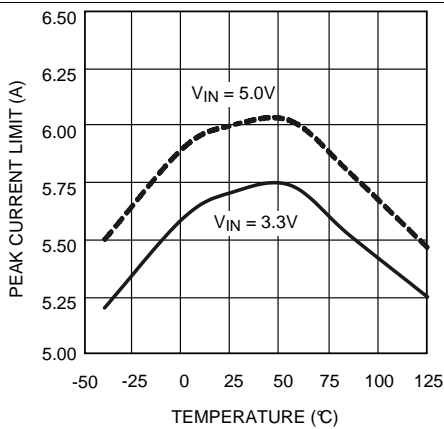

Figure 9. Peak Current Limit vs Temperature

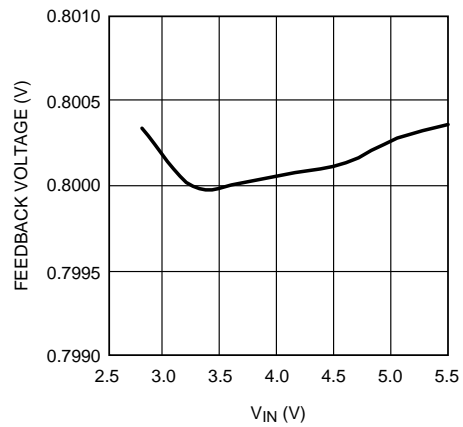

Figure 10. Feedback Voltage vs V_{IN}

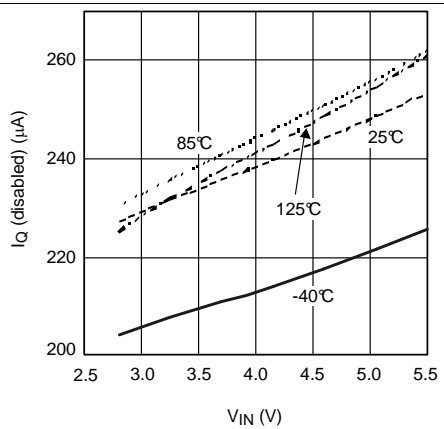

Figure 11. I_Q (disabled) vs V_{IN} and Temperature, $EN = 0\text{ V}$

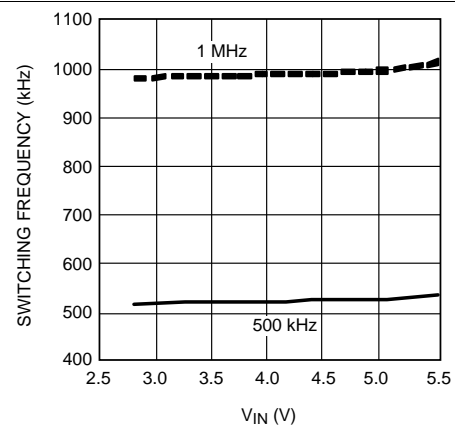

Figure 12. Switching Frequency vs V_{IN}

Typical Characteristics (continued)

Unless otherwise specified, the following conditions apply: $V_{IN} = P_{VIN} = A_{VIN} = EN = 5$, $T_J = 25^\circ\text{C}$.

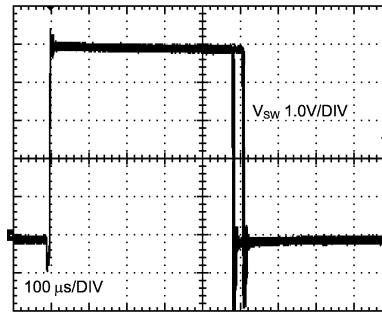

Figure 13. LM2854 500-kHz Switch Node Voltage (oscilloscope set at infinite persistence) $V_{IN} = 5$ V, $V_{OUT} = 2.5$ V, $I_{OUT} = 4$ A

7 Detailed Description

7.1 Overview

The LM2854 PowerWise synchronous DC-DC buck regulator belongs to the Texas Instruments family of switching regulators. Integration of the power MOSFETs and associated drivers, compensation component network, and the PWM controller reduces the number of external components necessary for a complete power supply design, without sacrificing performance.

7.2 Functional Block Diagram

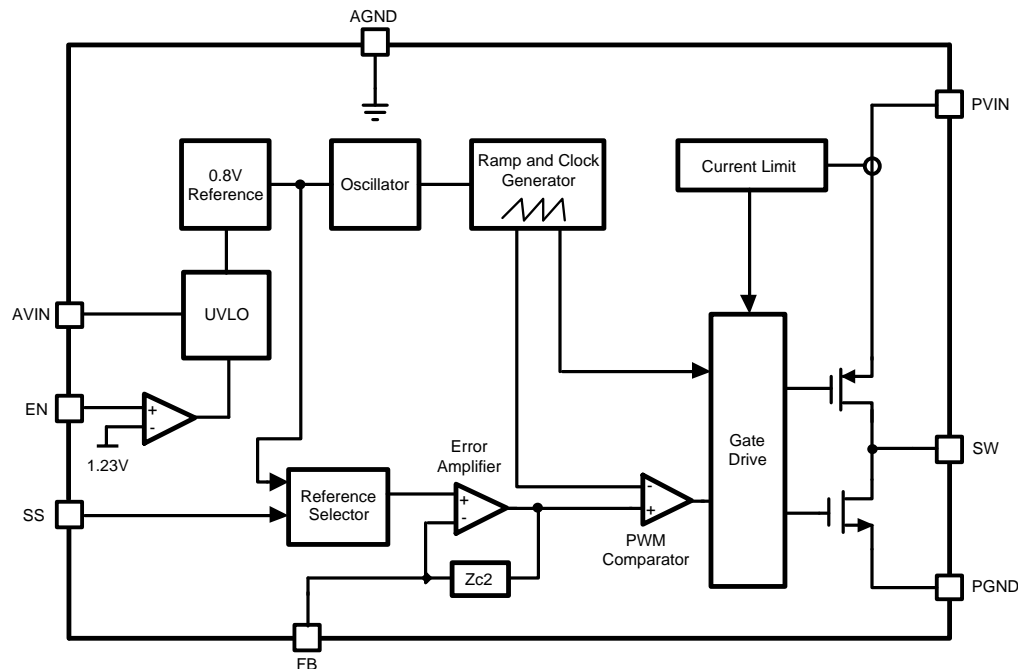

7.3 Feature Description

7.3.1 Switching Frequency

The LM2854 is available in two switching frequency options, 500 kHz and 1 MHz. Generally, a higher switching frequency allows for faster transient response and a reduction in the footprint area and volume of the external power stage components, while a lower switching frequency affords better efficiency. These factors should be considered when selecting the appropriate switching frequency for a given application.

7.3.2 Enable

The LM2854 features an enable (EN) pin and associated comparator to allow the user to easily sequence the LM2854 from an external voltage rail, or to manually set the input UVLO threshold. The turnon or rising threshold and hysteresis for this comparator are typically 1.23 V and 0.15 V, respectively. The precise reference for the enable comparator allows the user to ensure that the LM2854 will be disabled when the system demands it to be.

7.3.3 Soft-Start

The LM2854 begins to operate when both the AVIN and EN voltages exceed the rising UVLO and enable thresholds, respectively. A controlled soft-start eliminates inrush currents during start-up and allows the user more control and flexibility when sequencing the LM2854 with other power supplies. An external soft-start capacitor is used to control the LM2854 start-up time. During soft-start, the voltage on the feedback pin is connected internally to the non-inverting input of the error amplifier. The soft-start period lasts until the voltage on the soft-start pin exceeds the LM2854 reference voltage of 0.8 V. At this point, the reference voltage takes over at the non-inverting amplifier input.

Feature Description (continued)

In the event of either AVIN or EN decreasing below the falling UVLO or enable threshold respectively, the voltage on the soft-start pin is collapsed by discharging the soft-start capacitor through a 5-kΩ transistor to ground.

7.3.4 Tracking

The LM2854 can track the output of a master power supply during soft-start by connecting a resistor divider to the SS pin. In this way, the output voltage slew rate of the LM2854 will be controlled by a master supply for loads that require precise sequencing. When the tracking function is used, a small value soft-start capacitor can be connected to the SS pin to alleviate output voltage overshoot when recovering from a current limit fault.

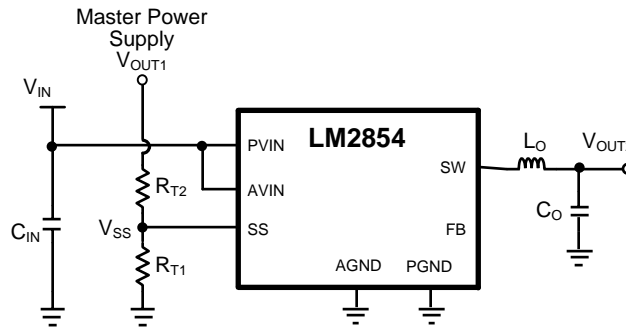

Figure 14. Simplified Schematic Showing Use of Tracking

7.3.5 Pre-Biased Start-up Capability

The LM2854 is in a pre-biased state when the device starts up with an output voltage greater than zero. This often occurs in many multi-rail applications such as when powering an FPGA, ASIC, or DSP. The output can be pre-biased in these applications through parasitic conduction paths from one supply rail to another. Even though the LM2854 is a synchronous converter, it will not pull the output low when a pre-bias condition exists. The LM2854 will not sink current during start up until the soft-start voltage exceeds the voltage on the FB pin. Since the device can not sink current it protects the load from damage that might otherwise occur if current is conducted through the parasitic paths of the load.

7.3.6 Feedback Voltage Accuracy

The FB pin is connected to the inverting input of the voltage loop error amplifier and during closed loop operation its reference voltage is 0.8 V. The FB voltage is accurate to within -1.25% / $+1\%$ over temperature. Additionally, the LM2854 contains error nulling circuitry to substantially eliminate the feedback voltage over temperature drift as well as the long term aging effects of the internal amplifiers. In addition, the $1/f$ noise of the bandgap amplifier and reference are dramatically reduced. The manifestation of this circuit action is that the duty cycle will have two slightly different but distinct operating points, each evident every other switching cycle. The oscilloscope plot shown previously of the SW pin with infinite persistence set shows this behavior. No discernible effect is evident on the output due to LC filter attenuation. For further information, a Texas Instruments white paper is available on this topic.

7.3.7 Positive Current Limit

The LM2854 employs lossless cycle-by-cycle high-side current limit circuitry to limit the peak current through the high-side FET. The peak current limit threshold, denoted I_{CL} , is nominally set at 6 A internally. When a current greater than I_{CL} is sensed through the PFET, its on-time is immediately terminated and the NFET is activated. The NFET stays on for the entire next four switching cycles (effectively four PFET pulses are skipped). During these skipped pulses, the voltage on the soft-start pin is reduced by discharging the soft-start capacitor by a current sink on the soft-start pin of nominally 6 μ A or 14 μ A for the 500-kHz or 1-MHz options, respectively. Subsequent overcurrent events will drain more and more charge from the soft-start capacitor, effectively decreasing the reference voltage as the output droops due to the pulse skipping. Reactivation of the soft-start circuitry ensures that when the overcurrent situation is removed, the part will resume normal operation smoothly.

Feature Description (continued)

7.3.8 Negative Current Limit

The LM2854 implements negative current limit detection circuitry to prevent large negative current in the inductor. When the negative current sensed in the low-side NFET is below approximately -0.4 A , the present switching cycle is immediately terminated and both FETs are turned off. When both FETs are off, the negative inductor current originally flowing in the low-side NFET and into the SW pin commutates to the high-side PFET's body diode and ramps back to zero. At this point, the SW pin becomes a high impedance node and ringing can be observed on the SW node as the stored energy in the inductor is dissipated while resonating with the parasitic nodal capacitance.

7.3.9 Overtemperature Protection

When the LM2854 senses a junction temperature greater than 165°C , both switching FETs are turned off and the part enters a sleep state. Upon sensing a junction temperature below 155°C , the part will re-initiate the soft-start sequence and begin switching once again. This feature is provided to prevent catastrophic failure due to excessive thermal dissipation.

7.3.10 Loop Compensation

The LM2854 preserves flexibility by integrating the control components around the error amplifier while using three small external compensation components from V_{OUT} to FB. An integrated type II (two pole, one zero) voltage-mode compensation network is featured. To ensure stability, an external resistor and small value capacitor can be added across the upper feedback resistor as a pole-zero pair to complete a type III (three pole, two zero) compensation network. For correct selection of these components, see [Detailed Design Procedure](#).

7.4 Device Functional Modes

7.4.1 Shutdown Mode

If EN is less than $V_{\text{IH}} - V_{\text{EN(HSY)}}$, the LM2854 shuts down. Most internal circuitry is shut down, and the SW output is high-impedance. Once EN voltage exceeds V_{IH} , the LM2854 enters soft-start mode.

7.4.2 Soft-Start and Track Mode

Once operation is initiated, the LM2854 starts charging its SS node. If a voltage is already present on the LM2854 circuit output, the LM2854 does not attempt to pull the circuit output low. If only a capacitor is connected to the SS pin, voltage on this pin rises, and once voltage exceeds 0.8 V , normal operating mode commences. If the high-side current limit is exceeded, the voltage on the SS pin is reduced, prolonging soft-start and track mode.

If a resistor divider is used to connect the SS pin to another power supply, Soft Start and Track mode can be used to cause the output of the LM2854 Buck to track this supply.

7.4.3 Normal Operating Mode

If the EN input of the LM2854 is above V_{IH} and the SS pin is above 0.8 V , output is regulated normally. If EN is reduced to less than $V_{\text{IH}} - V_{\text{EN(HSY)}}$, the LM2854 enters shutdown mode. If the high-side current limit is activated or SS is pulled to below 0.8 V , the LM2854 enters soft-start and track mode.

8 Application and Implementation

NOTE

Information in the following applications sections is not part of the TI component specification, and TI does not warrant its accuracy or completeness. TI's customers are responsible for determining suitability of components for their purposes. Customers should validate and test their design implementation to confirm system functionality.

8.1 Application Information

The LM2854 is designed to convert voltage between 2.95 V and 5.5 V to a well-regulated voltage between input voltage and 0.8 V.

8.2 Typical Application

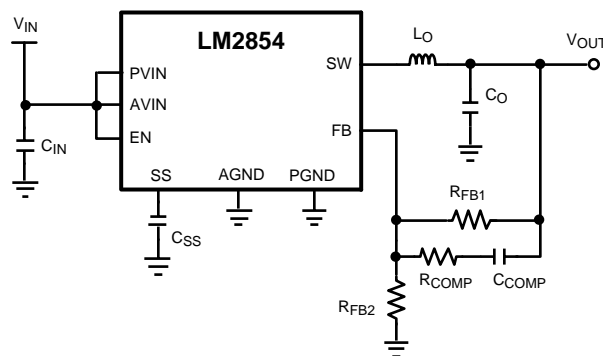

Figure 15. Typical Application Diagram

8.2.1 Design Requirements

Before starting a design, the following five design criteria should be considered. These criteria are the basic inputs into the detailed design procedure listed below.

- Output voltage: Choose an output voltage between 0.8 V and the lowest expected input voltage.
- Size vs efficiency: Choose 1 MHz for small physical size, and 500 kHz switching frequency for efficiency.
- Step load response and ripple: Use this criterion to select output capacitance. Also see compensation in [Detailed Design Procedure](#).
- UVLO: Input UVLO voltage should be selected. A voltage divider connected to the EN input can be used to select input start-up voltage.
- Tracking: If tracking is desired, a voltage divider can be connected to the SS node.

8.2.2 Detailed Design Procedure

8.2.2.1 Input Filter Capacitor

Fast switching currents place a large strain on the input supply to a buck regulator. A capacitor placed close to the PVIN and PGND pins of the LM2854 helps to supply the instantaneous charge required when the regulator demands a pulse of current every switching cycle. In fact, the input capacitor conducts a square-wave current of peak-to-peak amplitude equal to I_{OUT} . With this high AC current present in the input capacitor, the RMS current rating becomes an important parameter. The necessary RMS current rating of the input capacitor to a buck regulator can be estimated using [Equation 1](#).

$$I_{Cin(RMS)} = I_{OUT} \sqrt{D(1-D)} \quad (1)$$

where the PWM duty cycle, D , is given in [Equation 2](#).

$$D = \frac{V_{OUT}}{V_{IN}} \quad (2)$$

Typical Application (continued)

Neglecting capacitor ESR, the resultant input capacitor AC ripple voltage is a triangular waveform with peak-to-peak amplitude specified in [Equation 3](#).

$$\Delta V_{in} = \frac{V_{OUT}D(1-D)}{f_{SW}C_{IN}} \quad (3)$$

The maximum input capacitor ripple voltage and RMS current occur at 50% duty cycle. A 22- μF or 47- μF high-quality dielectric (X5R, X7R) ceramic capacitor with adequate voltage rating is typically sufficient as an input capacitor to the LM2854. The input capacitor should be placed as close as possible to the PVIN and PGND pins to substantially eliminate the parasitic effects of any stray inductance or resistance on the PC board and supply lines. Additional bulk capacitance with higher ESR may be required to damp any resonance effects of the input capacitance and parasitic inductance.

8.2.2.2 AVIN Filtering Components

In addition to the large input filter capacitor, a smaller ceramic capacitor such as a 0.1 μF or 1.0 μF is recommended between AVIN and AGND to filter high frequency noise present on the PVIN rail from the quiet AVIN supply. For additional filtering in noisy environments, a small RC filter can be used on the AVIN pin as shown below.

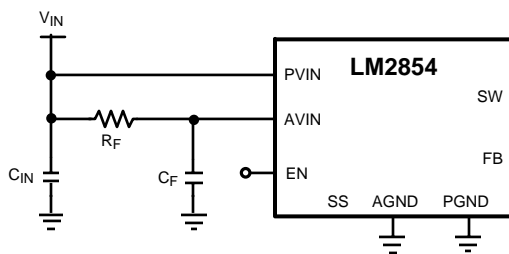

Figure 16. Filtering of AVIN

In general, R_F is typically selected between 1 Ω and 10 Ω so that the steady state voltage drop across the resistor due to the AVIN bias current does not affect the UVLO level. Recommended filter capacitor, C_F , is 1 μF in X5R or X7R dielectric.

8.2.2.3 Soft-Start Capacitor

When the LM2854 is enabled, the output voltage will ramp up linearly in the time dictated by the relationship shown in [Equation 4](#).

$$t_{SS} = \frac{C_{SS} \times V_{REF}}{I_{SS}} \quad (4)$$

where V_{REF} is the internal reference voltage (nominally 0.8V), I_{SS} is the soft-start charging current (nominally 2 μA) and C_{SS} is the external soft-start capacitance. Rearranging this equation allows for the necessary soft-start capacitor for a given start-up time to be calculated as in [Equation 5](#).

$$C_{SS} = \frac{t_{SS} \times 2 \mu\text{A}}{0.8\text{V}} \quad (5)$$

Thus, the required soft start capacitor per unit output voltage start-up time is given in [Equation 6](#).

$$C_{SS} = 2.5 \text{ nF} / \text{ms} \quad (6)$$

For example, a 10 nF soft-start capacitor will yield a 4 ms soft-start time.

8.2.2.4 Tracking - Equal Soft-Start Time

One way to use the tracking feature is to design the tracking resistor divider so that the master supply output voltage, V_{OUT1} , and the LM2854 output voltage, V_{OUT2} , both rise together and reach their target values at the same time. This is termed ratiometric start-up. For this case, the equation governing the values of tracking divider resistors R_{T1} and R_{T2} is given in [Equation 7](#).

Typical Application (continued)

$$R_{T1} = \frac{R_{T2}}{V_{OUT1} - 1.0V} \tag{7}$$

The above equation includes an offset voltage to ensure that the final value of the SS pin voltage exceeds the reference voltage of the LM2854. This offset will cause the LM2854 output voltage to reach regulation slightly before the master supply. A value of 33 kΩ 1% is recommended for R_{T2} as a compromise between high precision and low quiescent current through the divider while minimizing the effect of the 2 μA soft-start current source.

For example, If the master supply voltage V_{OUT1} is 3.3V and the LM2854 output voltage was 1.8V, then the value of R_{T1} needed to give the two supplies identical soft-start times would be 14.3 kΩ. A timing diagram for this example, the equal soft-start time case, is shown in [Figure 17](#).

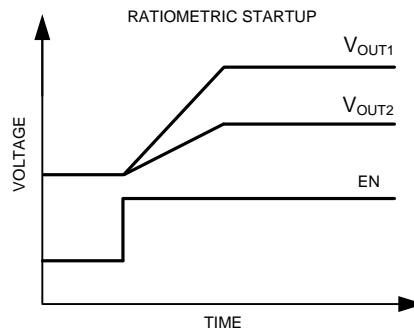

Figure 17. Simplified Start-up Waveforms When Using Proportional Tracking

8.2.2.5 Tracking - Equal Slew Rates

Alternatively, the tracking feature can be used to have similar output voltage ramp rates. This is referred to as simultaneous start-up. In this case, the tracking resistors can be calculated using [Equation 8](#).

$$R_{T1} = \frac{0.8V}{V_{OUT2} - 0.8V} R_{T2} \tag{8}$$

and to ensure proper overdrive of the SS pin as calculated in [Equation 9](#).

$$V_{OUT2} < 0.8 V_{OUT1} \tag{9}$$

For the example case of V_{OUT1} = 5 V and V_{OUT2} = 2.5 V, with R_{T2} set to 33 kΩ as before, R_{T1} is calculated from the above equation to be 15.5 kΩ. A timing diagram for the case of equal slew rates is shown in [Figure 18](#).

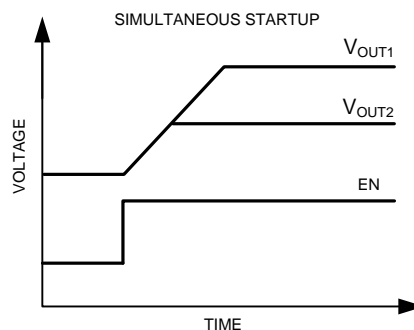

Figure 18. Simplified Start-up Waveforms, Showing Tracking Used to Achieve Equal Slew Rates

Typical Application (continued)

8.2.2.6 Enable and UVLO

Using a resistor divider from V_{IN} to EN as shown in the schematic diagram below, the input voltage at which the part begins switching can be increased above the normal input UVLO level as shown in Equation 10.

$$V_{IN(UVLO)} = 1.23V \frac{R_{EN1} + R_{EN2}}{R_{EN2}} \quad (10)$$

For example, suppose that the required input UVLO level is 3.69 V. Choosing $R_{EN2} = 10 \text{ k}\Omega$, then we calculate $R_{EN1} = 20 \text{ k}\Omega$.

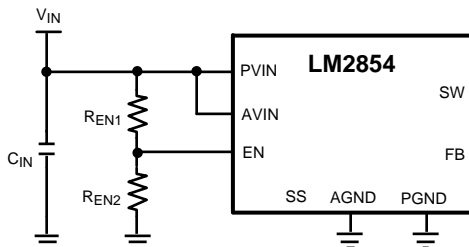

Figure 19. Simplified Schematic Showing Use of EN as an Input UVLO

Alternatively, the EN pin can be driven from another voltage source to cater for system sequencing requirements commonly found in FPGA and other multi-rail applications. The following schematic shows an LM2854 that is sequenced to start based on the voltage level of a master system rail.

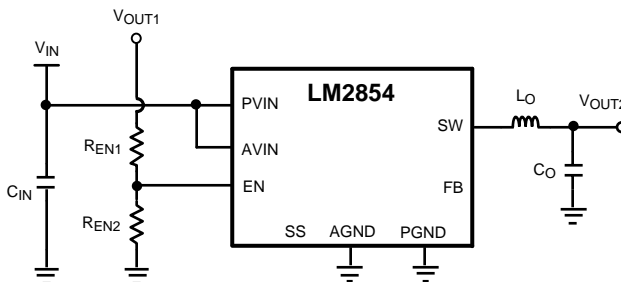

Figure 20. Simplified Schematic Showing EN Used to Cascade Power Supply Start-up

8.2.2.7 Output Voltage Setting

A divider resistor network from V_{OUT} to the FB pin determines the desired output voltage as shown in Equation 11.

$$V_{OUT} = 0.8V \frac{R_{FB1} + R_{FB2}}{R_{FB2}} \quad (11)$$

R_{FB1} is defined based on the voltage loop requirements and R_{FB2} is then selected for the desired output voltage. These resistors are normally selected as 0.5% or 1% tolerance.

8.2.2.8 Compensation Component Selection

The power stage transfer function of a voltage mode buck converter has a complex double pole related to the LC output filter and a left half plane zero due to the output capacitor ESR, denoted R_{ESR} . The locations of these singularities are given respectively in Equation 12.

Typical Application (continued)

$$f_{LC} = \frac{1}{2\pi \sqrt{L_O C_O \left(\frac{R_{ESR} + R_L}{R_{DCR} + R_L} \right)}} \cong \frac{1}{2\pi \sqrt{L_O C_O}}$$

$$f_{ESR} = \frac{1}{2\pi R_{ESR} C_O}$$

where

- C_O is the output capacitance value appropriately derated for applied voltage and operating temperature
- R_L is the effective load resistance
- R_{DCR} is the series damping resistance associated with the inductor and power switches (12)

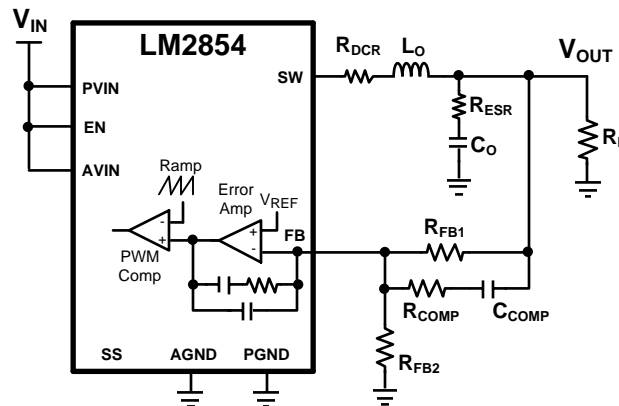

Figure 21. LM2854 Compensation Scheme

The conventional compensation strategy employed with voltage mode control is to use two compensator zeros to offset the LC double pole, one compensator pole located to cancel the output capacitor ESR zero and one compensator pole located between one third and one half switching frequency for high frequency noise attenuation.

The LM2854 internal compensation components are designed to locate a pole at the origin and a pole at high frequency as mentioned above. Furthermore, a zero is located at 8.8 kHz or 17.6 kHz for the 500 kHz or 1 MHz options, respectively, to approximately cancel the likely location of one LC filter pole.

The three external compensation components, R_{FB1} , R_{COMP} and C_{COMP} , are selected to position a zero at or below the LC pole location and a pole to cancel the ESR zero. The voltage loop crossover frequency, f_{loop} , is usually selected between one tenth to one fifth of the switching frequency, as shown in [Equation 13](#).

$$0.1f_{SW} \leq f_{loop} \leq 0.2f_{SW} \quad (13)$$

A simple solution for the required external compensation capacitor, C_{COMP} , with type III voltage mode control can be expressed as in [Equation 14](#).

$$C_{COMP}(\text{pF}) = \alpha \frac{L_O(\mu\text{H})C_O(\mu\text{F})}{V_{IN}(\text{V})} f_{loop}(\text{kHz}) \quad (14)$$

where the constant α is nominally 0.038 or 0.075 for the 500 kHz or 1 MHz options, respectively. This assumes a compensator pole cancels the output capacitor ESR zero. Furthermore, since the modulator gain is proportional to V_{IN} , the loop crossover frequency increases with V_{IN} . Thus, it is recommended to design the loop at maximum expected V_{IN} .

The upper feedback resistor, R_{FB1} , is selected to provide adequate mid-band gain and to locate a zero at or below the LC pole frequency. The series resistor, R_{COMP} , is selected to locate a pole at the ESR zero frequency, as shown in [Equation 15](#).

Typical Application (continued)

$$R_{FB1} = \frac{1}{2\pi C_{COMP} f_{LC}}$$

$$R_{COMP} = \frac{1}{2\pi C_{COMP} f_{ESR}}$$
(15)

Note that the lower feedback resistor, R_{FB2} , has no impact on the control loop from an AC standpoint since the FB pin is the input to an error amplifier and effectively at AC ground. Hence, the control loop can be designed irrespective of output voltage level. The only caveat here is the necessary derating of the output capacitance with applied voltage. Having chosen R_{FB1} as above, R_{FB2} is then selected for the desired output voltage.

[Table 1](#) and [Table 2](#) list inductor and ranges of capacitor values that work well with the LM2854, along with the associated compensation components to ensure stable operation. Values different than those listed may be used, but the compensation components may need to be recalculated to avoid degradation in phase margin. Note that the capacitance ranges specified refer to in-circuit values where the nominal capacitance value is adequately derated for applied voltage.

8.2.2.9 Filter Inductor and Output Capacitor Selection

In a buck regulator, selection of the filter inductor and capacitor will affect many key system parameters, including stability, transient response and efficiency. The LM2854 can accommodate relatively wide ranges of output capacitor and filter inductor values in a typical application and still achieve excellent load current transient performance and low output voltage ripple.

The inductance is chosen such that the peak-to-peak inductor current ripple, Δi_L , is approximately 25 to 40% of I_{OUT} as shown in [Equation 16](#).

$$L_O = \frac{V_{OUT}(1-D)}{\Delta i_L f_{SW}} \cong \frac{V_{OUT}(1-D)}{0.3 I_{OUT} f_{SW}}$$
(16)

Note that the peak inductor current is the DC output current plus half the ripple current and reaches its highest level at lowest duty cycle (or highest V_{IN}). It is recommended that the inductor should have a saturation current rating in excess of the current limit level.

When operating the LM2854 at input voltages above 5.2 V, the inductor should be sized to keep the minimum inductor current above -0.5 A. For most applications this should only occur at light loads or when the inductor is drastically undersized. To ensure the current never goes below -0.5 A for any application, the peak-to-peak ripple current (Δi_L) in the inductor should be less than 1 A. Keeping the minimum inductor current above -0.5 A limits the energy storage in the inductor and helps prevent the switch node voltage from exceeding the absolute maximum specification when the low side FET turns off.

[Table 3](#) lists examples of off-the-shelf powdered iron and ferrite based inductors that are suitable for use with the LM2854. The output capacitor can be of ceramic or electrolytic chemistry. The chosen output capacitor requires sufficient DC voltage rating and RMS ripple current handling capability.

The output capacitor RMS current and peak-to-peak output ripple are given respectively as in [Equation 17](#).

$$I_{Cout(RMS)} = \frac{\Delta i_L}{\sqrt{12}}$$

$$\Delta V_{OUT} = \Delta i_L \sqrt{R_{ESR}^2 + \left(\frac{1}{8f_{SW}C_O}\right)^2}$$
(17)

In general, 22 μ F to 100 μ F of ceramic output capacitance is sufficient for both LM2854 frequency options given the optimal high frequency characteristics and low ESR of ceramic dielectric. It is advisable to consult the manufacturer's derating curves for capacitance voltage coefficient as the in-circuit capacitance may drop significantly with applied voltage.

Typical Application (continued)

Tantalum or organic polymer electrolytic capacitance may be suitable with the LM2854 500 kHz option, particularly in applications where substantial bulk capacitance per unit volume is required. However, the high loop bandwidth achievable with the LM2854 obviates the necessity for large bulk capacitance during transient loading conditions.

Table 4 lists some examples of commercially available capacitors that can be used with the LM2854.

Table 1. LM2854 500-kHz Compensation Component Values

V_{IN} (V)	L_O (μ H)	C_O (μ F)		ESR (m Ω)		R_{FB1} (k Ω)	C_{COMP} (pF)	R_{COMP} (k Ω)
		MIN	MAX	MIN	MAX			
5	1.5	40	100	2	10	150	47	1
	1.5	100	200	1	5	150	100	1
	1.5	100	220	15	25	150	120	25
	2.2	40	100	2	10	150	68	1
	2.2	100	200	1	5	150	120	1
	2.2	100	220	15	25	120	120	15
3.3	1.5	40	100	2	10	150	68	1
	1.5	100	200	1	5	100	150	1
	1.5	100	220	15	25	100	150	15
	2.2	40	100	2	10	150	100	1
	2.2	100	200	1	5	100	220	1
	2.2	100	220	15	25	100	220	10

Table 2. LM2854 1-MHz Compensation Component Values

V_{IN} (V)	L_O (μ H)	C_O (μ F)		ESR (m Ω)		R_{FB1} (k Ω)	C_{COMP} (pF)	R_{COMP} (k Ω)
		MIN	MAX	MIN	MAX			
5	0.68	20	60	2	10	120	33	1
	0.68	60	150	1	5	75	100	1
	0.68	100	220	15	25	100	100	20
	1	20	60	2	10	100	56	1
	1	60	150	1	5	75	150	1
	1	100	220	15	25	75	150	15
3.3	0.68	20	60	2	10	75	56	1
	0.68	60	150	1	5	50	150	1
	0.68	100	220	15	25	50	150	12
	1	20	60	2	10	75	82	1
	1	60	150	1	5	50	220	1
	1	100	220	15	25	33	330	10

Table 3. Recommended Filter Inductors

INDUCTANCE (μ H)	DCR (m Ω)	MANUFACTURER	MANUFACTURER P/N	CASE SIZE (mm)
0.47	14.5	Vishay Dale	IHLP1616BZERR47M11	4.06 × 4.45 × 2.00
1	24	Vishay Dale	IHLP1616BZER1R0M11	4.06 × 4.45 × 2.00
0.47	8.4	Vishay Dale	IHLP2525AHERR47M01	6.47 × 6.86 × 1.80
0.47	6	Vishay Dale	IHLP2525BDERR47M01	6.47 × 6.86 × 2.40
0.68	8.7	Vishay Dale	IHLP2525BDERR68M01	6.47 × 6.86 × 2.40
0.82	10.6	Vishay Dale	IHLP2525BDERR82M01	6.47 × 6.86 × 2.40
1	13.1	Vishay Dale	IHLP2525BDER1R0M01	6.47 × 6.86 × 2.40
1.5	18.5	Vishay Dale	IHLP2525BDER1R5M01	6.47 × 6.86 × 2.40

Table 3. Recommended Filter Inductors (continued)

INDUCTANCE (μH)	DCR ($\text{m}\Omega$)	MANUFACTURER	MANUFACTURER P/N	CASE SIZE (mm)
2.2	15.7	Vishay Dale	IHLP2525CZER2R2M11	6.47 × 6.86 × 3.00
0.47	3.5	Sumida	CDMC6D28NP-R47M	6.50 × 7.25 × 3.00
0.68	4.5	Sumida	CDMC6D28NP-R68M	6.50 × 7.25 × 3.00
1	17.3	Sumida	CDMC6D28NP-1R0M	6.50 × 7.25 × 3.00
1.5	10.4	Sumida	CDMC6D28NP-1R5M	6.50 × 7.25 × 3.00
2.2	16.1	Sumida	CDMC6D28NP-2R2M	6.50 × 7.25 × 3.00
0.56	10	Coilcraft	DO1813H-561ML	6.10 × 8.89 × 5.00
0.47	3.3	Coilcraft	HA3619-471ALC	7 × 7 × 3
0.68	4.8	Coilcraft	HA3619-681ALC	7 × 7 × 3
1	7.5	Coilcraft	HA3619-102ALC	7 × 7 × 3
1.2	9.4	Coilcraft	HA3619-122ALC	7 × 7 × 3
1.5	11.5	Coilcraft	HA3619-152ALC	7 × 7 × 3
1.8	16.5	Coilcraft	HA3619-182ALC	7 × 7 × 3
0.47	3.3	TDK	SPM6530T-R47M170	7.1 × 6.5 × 3
0.68	4.9	TDK	SPM6530T-R68M140	7.1 × 6.5 × 3
1	7.1	TDK	SPM6530T-1R0M120	7.1 × 6.5 × 3
1.5	9.7	TDK	SPM6530T-1R5M100	7.1 × 6.5 × 3
0.47	14	Cyntec	PCMC042T-0R47MN	4 × 4.5 × 2
1.0	9	Cyntec	PCMC063T-1R0MN	6.5 × 6.9 × 3
1.5	14	Cyntec	PCMC063T-1R5MN	6.5 × 6.9 × 3

Table 4. Recommended Filter Capacitors

CAPACITANCE (μF)	VOLTAGE (V), ESR ($\text{m}\Omega$)	CHEMISTRY	MANUFACTURER	MANUFACTURER P/N	CASE SIZE
22	6.3, < 5	Ceramic, X5R	TDK	C3216X5R0J226M	1206
47	6.3, < 5	Ceramic, X5R	TDK	C3216X5R0J476M	1206
47	6.3, < 5	Ceramic, X5R	TDK	C3225X5R0J476M	1210
47	10, < 5	Ceramic, X5R	TDK	C3225X5R1A476M	1210
100	6.3, < 5	Ceramic, X5R	TDK	C3225X5R0J107M	1210
100	6.3, 50	Tantalum	AVX	TPSD157M006#0050	D, 7.5 × 4.3 × 2.9 mm
100	6.3, 25	Organic Polymer	Sanyo	6TPE100MPB2	B2, 3.5 × 2.8 × 1.9 mm
150	6.3, 18	Organic Polymer	Sanyo	6TPE150MIC2	C2, 6 × 3.2 × 1.8 mm
330	6.3, 18	Organic Polymer	Sanyo	6TPE330MIL	D3L, 7.3 × 4.3 × 2.8 mm
470	6.3, 23	Niobium Oxide	AVX	NOME37M006#0023	E, 7.3 × 4.3 × 4.1 mm

8.2.3 Application Curves

Unless otherwise specified, the following conditions apply: $V_{IN} = P_{VIN} = A_{VIN} = E_N = 5\text{ V}$, C_{IN} is 47- μF 10-V X5R ceramic capacitor, L_O is from TDK SPM6530T family; $T_{AMBIENT} = 25^\circ\text{C}$.

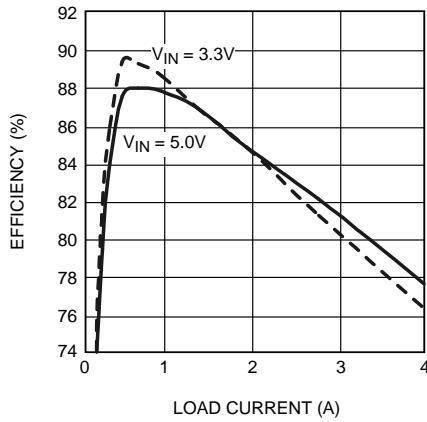

Figure 22. LM2854 1-MHz Efficiency vs I_{OUT} $V_{OUT} = 0.8\text{ V}$, $L_O = 0.47\ \mu\text{H}$, 3.3-m Ω DCR

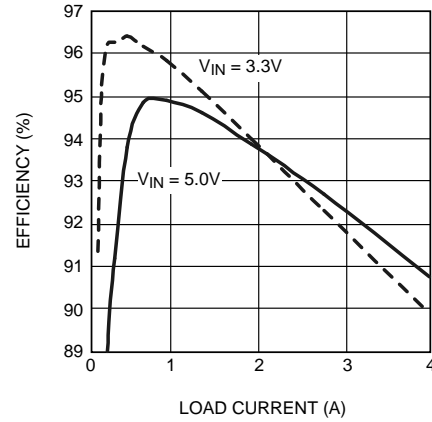

Figure 23. LM2854 1-MHz Efficiency vs I_{OUT} $V_{OUT} = 2.5\text{ V}$, $L_O = 1\ \mu\text{H}$, 7.1-m Ω DCR

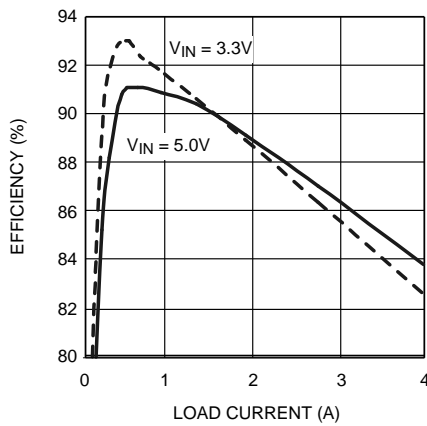

Figure 24. LM2854 1-MHz Efficiency vs I_{OUT} $V_{OUT} = 1.2\text{ V}$, $L_O = 0.68\ \mu\text{H}$, 4.9-m Ω DCR

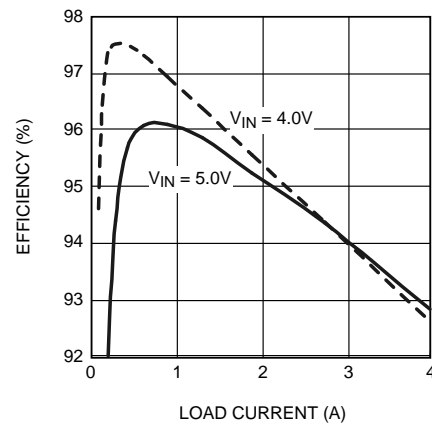

Figure 25. LM2854 1-MHz Efficiency vs I_{OUT} $V_{OUT} = 3.3\text{ V}$, $L_O = 1\ \mu\text{H}$, 7.1-m Ω DCR

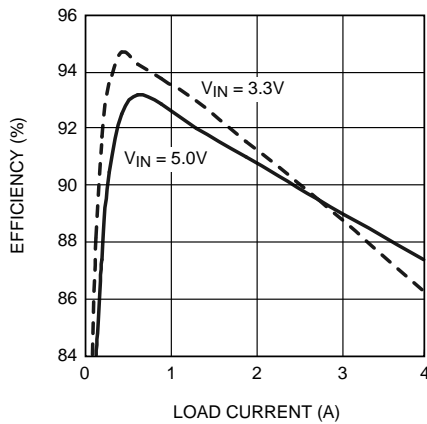

Figure 26. LM2854 1-MHz Efficiency vs I_{OUT} $V_{OUT} = 1.8\text{ V}$, $L_O = 1\ \mu\text{H}$, 7.1-m Ω DCR

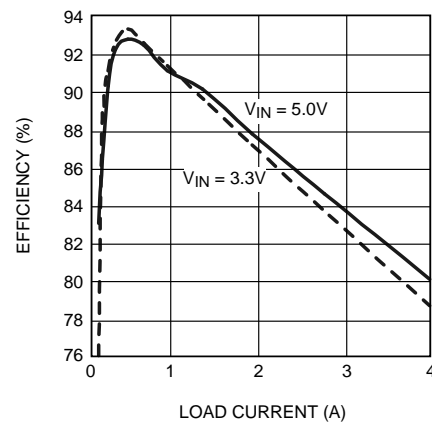

Figure 27. LM2854 500-kHz Efficiency vs I_{OUT} $V_{OUT} = 0.8\text{ V}$, $L_O = 1\ \mu\text{H}$, 7.1-m Ω DCR

Unless otherwise specified, the following conditions apply: $V_{IN} = P_{VIN} = A_{VIN} = E_N = 5\text{ V}$, C_{IN} is 47- μF 10-V X5R ceramic capacitor, L_O is from TDK SPM6530T family; $T_{AMBIENT} = 25^\circ\text{C}$.

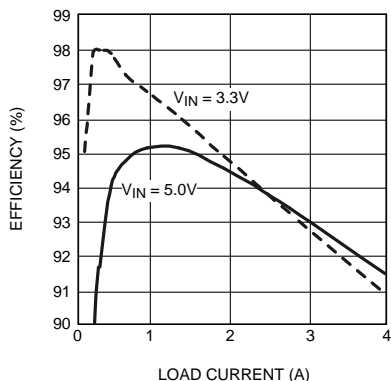

Figure 28. LM2854 500-kHz Efficiency vs I_{OUT} $V_{OUT} = 2.5\text{ V}$, $L_O = 2.2\ \mu\text{H}$, 16-m Ω DCR

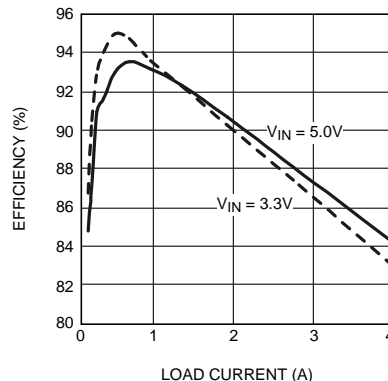

Figure 29. LM2854 500-kHz Efficiency vs I_{OUT} $V_{OUT} = 1.2\text{ V}$, $L_O = 1.5\ \mu\text{H}$, 9.7-m Ω DCR

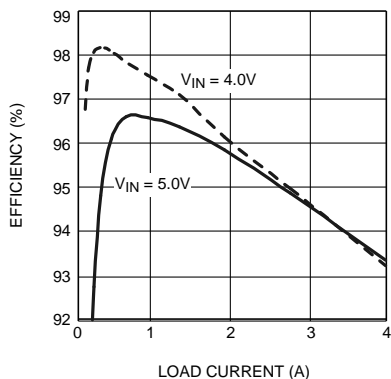

Figure 30. LM2854 500-kHz Efficiency vs I_{OUT} $V_{OUT} = 3.3\text{ V}$, $L_O = 1.5\ \mu\text{H}$, 9.7-m Ω DCR

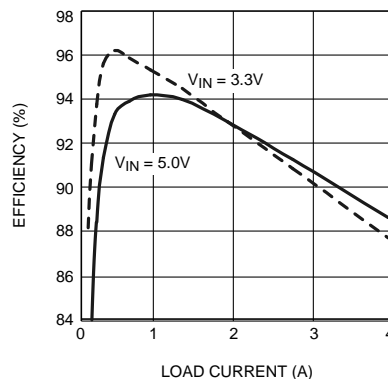

Figure 31. LM2854 500-kHz Efficiency vs I_{OUT} $V_{OUT} = 1.8\text{ V}$, $L_O = 1.5\ \mu\text{H}$, 9.7-m Ω DCR

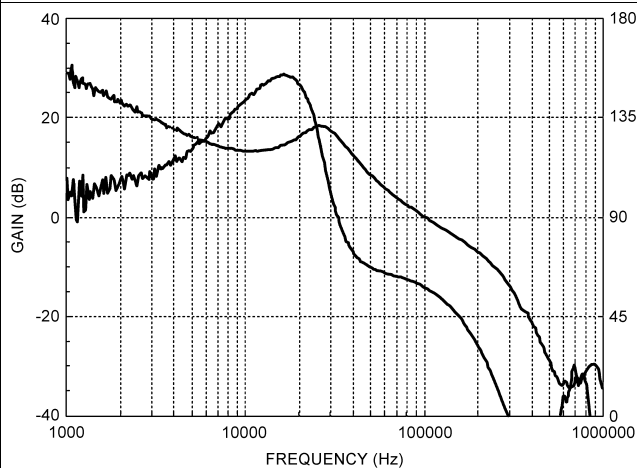

Figure 32. LM2854 1-MHz Bode Plot $V_{IN} = 3.3\text{ V}$, $V_{OUT} = 1.8\text{ V}$, $I_{OUT} = 4\text{ A}$ $R_{FB1} = 150\text{ k}\Omega$, $R_{COMP} = 1\text{ k}\Omega$, $C_{COMP} = 100\text{ pF}$, $L_{OUT} = 0.82\ \mu\text{H}$, $C_{OUT} = 100\text{-}\mu\text{F}$ Ceramic

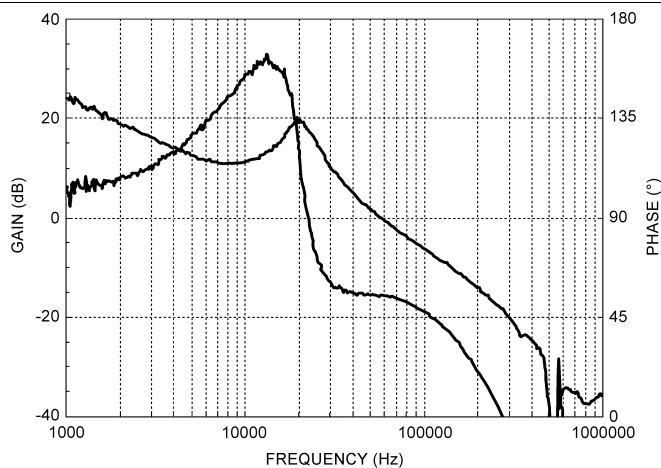

Figure 33. LM2854 500-kHz Bode Plot $V_{IN} = 3.3\text{ V}$, $V_{OUT} = 1.8\text{ V}$, $I_{OUT} = 4\text{ A}$ $R_{FB1} = 250\text{ k}\Omega$, $R_{COMP} = 1\text{ k}\Omega$, $C_{COMP} = 47\text{ pF}$, $L_{OUT} = 1.5\ \mu\text{H}$, $C_{OUT} = 100\text{-}\mu\text{F}$ Ceramic

Unless otherwise specified, the following conditions apply: $V_{IN} = PV_{IN} = AV_{IN} = EN = 5\text{ V}$, C_{IN} is 47- μF 10-V X5R ceramic capacitor, L_O is from TDK SPM6530T family; $T_{AMBIENT} = 25^\circ\text{C}$.

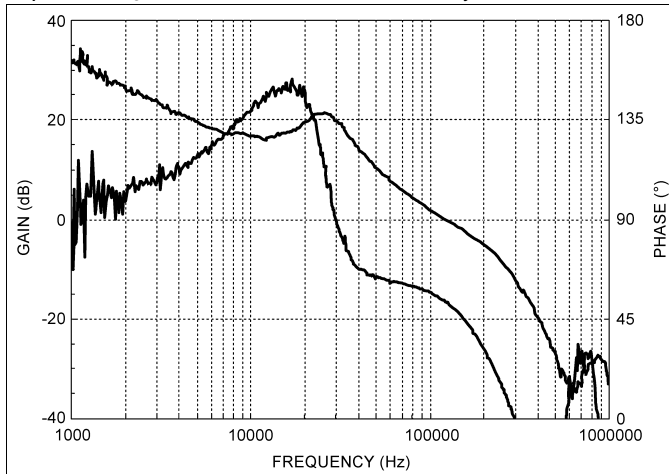

Figure 34. LM2854 1-MHz Bode Plot $V_{IN} = 5\text{ V}$, $V_{OUT} = 1.8\text{ V}$, $I_{OUT} = 4\text{ A}$ $R_{FB1} = 150\text{ k}\Omega$, $R_{COMP} = 1\text{ k}\Omega$, $C_{COMP} = 100\text{ pF}$, $L_{OUT} = 0.82\text{ }\mu\text{H}$, $C_{OUT} = 100\text{ }\mu\text{F}$

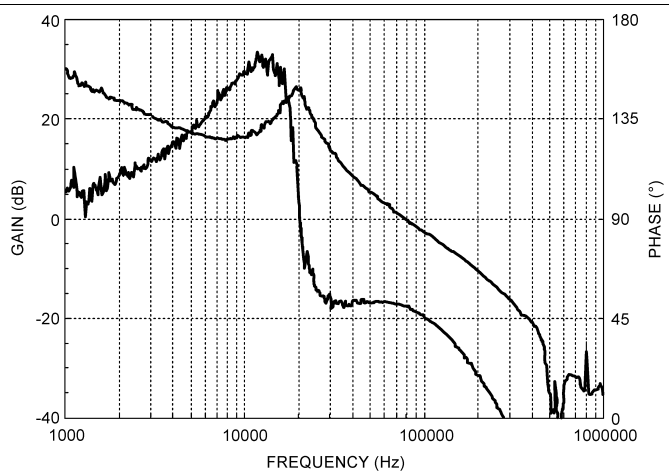

Figure 35. LM2854 500-kHz Bode Plot $V_{IN} = 5\text{ V}$, $V_{OUT} = 1.8\text{ V}$, $I_{OUT} = 4\text{ A}$ $R_{FB1} = 250\text{ k}\Omega$, $R_{COMP} = 1\text{ k}\Omega$, $C_{COMP} = 47\text{ pF}$, $L_{OUT} = 1.5\text{ }\mu\text{H}$, $C_{OUT} = 100\text{-}\mu\text{F Ceramic}$

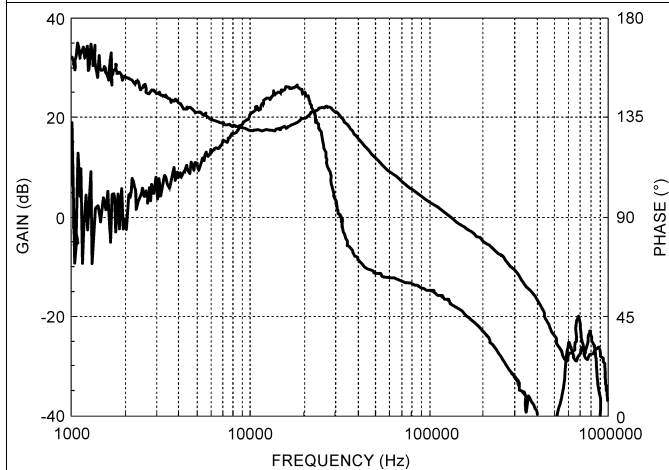

Figure 36. LM2854 1-MHz Bode Plot $V_{IN} = 5\text{ V}$, $V_{OUT} = 3.3\text{ V}$, $I_{OUT} = 4\text{ A}$ $R_{FB1} = 150\text{ k}\Omega$, $R_{COMP} = 1\text{ k}\Omega$, $C_{COMP} = 68\text{ pF}$, $L_{OUT} = 0.82\text{ }\mu\text{H}$, $C_{OUT} = 100\text{-}\mu\text{F Ceramic}$

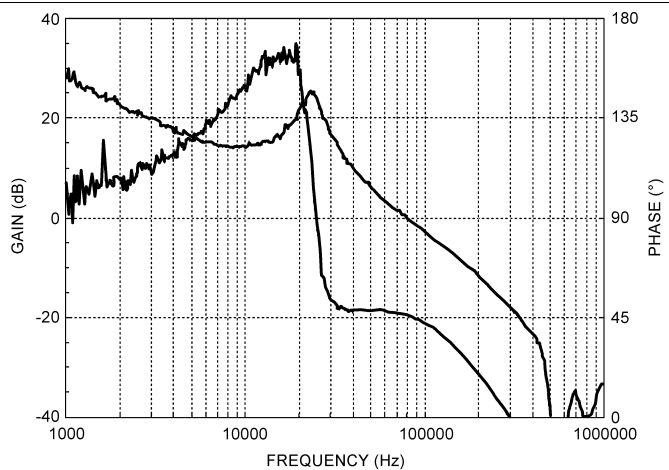

Figure 37. LM2854 500-kHz Bode Plot $V_{IN} = 5\text{ V}$, $V_{OUT} = 3.3\text{ V}$, $I_{OUT} = 4\text{ A}$ $R_{FB1} = 250\text{ k}\Omega$, $R_{COMP} = 1\text{ k}\Omega$, $C_{COMP} = 33\text{ pF}$, $L_{OUT} = 1.5\text{ }\mu\text{H}$, $C_{OUT} = 100\text{-}\mu\text{F Ceramic}$

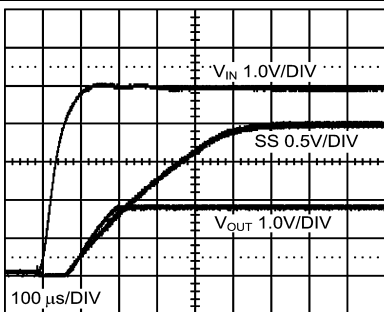

Figure 38. LM2854 500-kHz Power On Characteristic $V_{IN} = 5\text{ V}$, $V_{OUT} = 1.8\text{ V}$, $I_{OUT} = 4\text{ A}$, $C_{SS} = 220\text{ pF}$

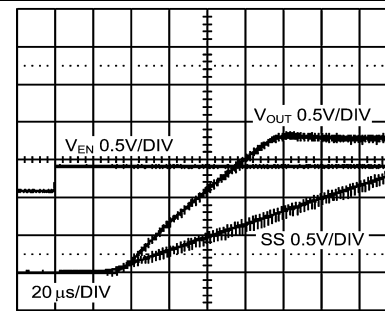

Figure 39. LM2854 500-kHz Power On through Enable $V_{IN} = 5\text{ V}$, $V_{OUT} = 1.8\text{ V}$, $I_{OUT} = 4\text{ A}$, $C_{SS} = 220\text{ pF}$

Unless otherwise specified, the following conditions apply: $V_{IN} = PV_{IN} = AV_{IN} = EN = 5\text{ V}$, C_{IN} is 47- μF 10-V X5R ceramic capacitor, L_O is from TDK SPM6530T family; $T_{AMBIENT} = 25^\circ\text{C}$.

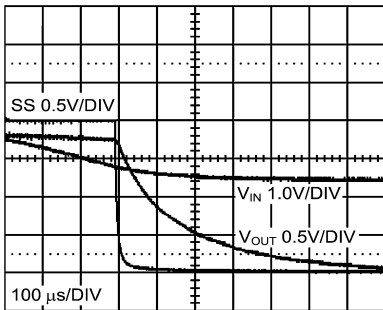

Figure 40. LM2854 500-kHz Power Off Characteristic
 $V_{IN} = 5\text{ V}$, $V_{OUT} = 1.8\text{ V}$, $I_{OUT} = 4\text{ A}$, $C_{SS} = 220\text{ pF}$

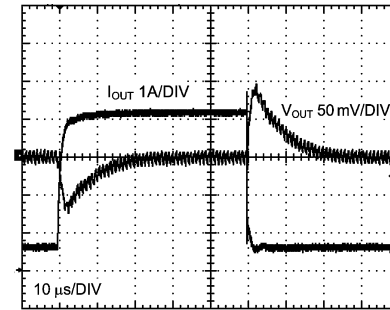

Figure 41. LM2854 1-MHz Load Transient Response
 $V_{IN} = 5\text{ V}$, $V_{OUT} = 3.3\text{ V}$, $I_{OUT} = 0.5\text{-A to 4-A to 0.5-A}$ step
 $di/dt \approx 4\text{ A}/\mu\text{s}$, $C_O = 100\text{-}\mu\text{F}$ Ceramic

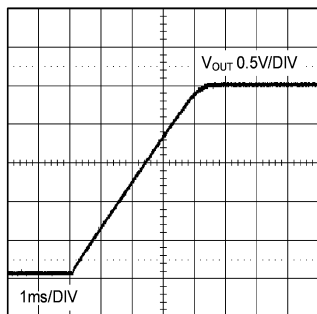

Figure 42. LM2854 500-kHz Start-up Waveform $V_{OUT} = 2.5\text{ V}$, $I_{OUT} = 0\text{ A}$

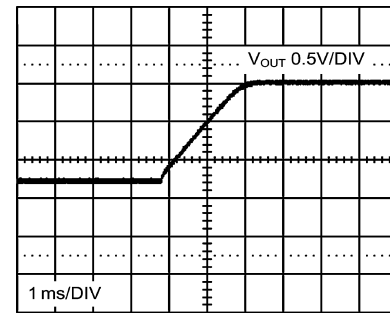

Figure 43. LM2854 500-kHz Pre-Biased Start-up Waveform (Oscilloscope Set at Infinite Persistence) $V_{OUT} = 2.5\text{ V}$, $I_{OUT} = 0\text{ A}$, $V_{PRE-BIAS} = 1.25\text{ V}$

8.2.4 System Examples

This section provides several application solutions with an associated bill of materials, listed in [Table 5](#) to [Table 7](#). All bill of materials reference the schematic in [Figure 44](#). The compensation for each solution was optimized to work over the full input range. Many applications have a fixed input voltage rail. It is possible to modify the compensation to obtain a faster transient response for a given input voltage operating point.

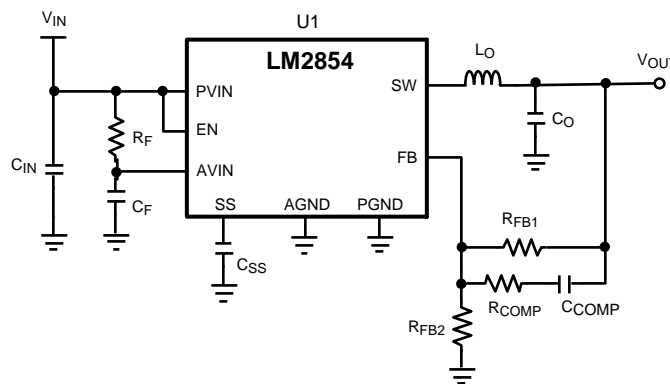

Figure 44. LM2854 Application Circuit Schematic

Unless otherwise specified, the following conditions apply: $V_{IN} = P_{VIN} = A_{VIN} = E_N = 5\text{ V}$, C_{IN} is 47- μF 10-V X5R ceramic capacitor, L_O is from TDK SPM6530T family; $T_{AMBIENT} = 25^\circ\text{C}$.

Table 5. LM2854 500-kHz Bill of Materials, $V_{IN} = 5\text{ V}$, $V_{OUT} = 3.3\text{ V}$, $I_{OUT(MAX)} = 4\text{ A}$, Optimized for Efficiency

REF DES	DESCRIPTION	CASE SIZE	MANUFACTURER	MANUFACTURER P/N
U1	Synchronous Buck Regulator	HTSSOP-16	Texas Instruments	LM2854MHX-500
C_{IN}	47 μF , X5R, 10 V	1210	TDK	C3225X5R1A476M
C_O	100 μF , X5R, 6.3 V	1210	TDK	C3225X5R0J107M
L_O	1.5 μH , 9.7 m Ω , 10 A	7.1 × 6.5 × 3.0 mm	TDK	SPM6530T-1R5M100
R_{FB1}	249 k Ω	0603	Vishay Dale	CRCW06032493F-e3
R_{FB2}	80.6 k Ω	0603	Vishay Dale	CRCW060328062F-e3
R_{COMP}	1 k Ω	0603	Vishay Dale	CRCW06031001F-e3
R_F	1 Ω	0603	Vishay Dale	CRCW06031R0F-e3
C_{COMP}	33 pF, $\pm 5\%$, C0G, 50 V	0603	TDK	C1608C0G1H330J
C_{SS}	10 nF, $\pm 10\%$, X7R, 16 V	0603	Murata	GRM188R71C103KA01
C_F	1.0 μF , $\pm 10\%$, X7R, 10 V	0603	Murata	GRM188R71A105KA61

Table 6. LM2854 1-MHz Bill of Materials, $V_{IN} = 3.3\text{ V}$ to 5 V, $V_{OUT} = 2.5\text{ V}$, $I_{OUT(MAX)} = 4\text{ A}$, Optimized for Electrolytic Input and Output Capacitance

REF DES	DESCRIPTION	CASE SIZE	MANUFACTURER	MANUFACTURER P/N
U1	Synchronous Buck Regulator	HTSSOP-16	Texas Instruments	LM2854MHX-1000
C_{IN}	150 μF , 6.3 V, 18 m Ω	C2, 6 × 3.2 × 1.8 mm	Sanyo	6TPE150MIC2
C_O	330 μF , 6.3 V, 18 m Ω	D3L, 7.3 × 4.3 × 2.8 mm	Sanyo	6TPE330MIL
L_O	2.2 μH , 16 m Ω , 7 A	6.47 × 6.86 × 3 mm	Vishay Dale	IHLP2525CZER2R2M11
R_{FB1}	100 k Ω	0603	Vishay Dale	CRCW06031003F-e3
R_{FB2}	47.5 k Ω	0603	Vishay Dale	CRCW060324752F-e3
R_{COMP}	15 k Ω	0603	Vishay Dale	CRCW06031502F-e3
R_F	1 Ω	0603	Vishay Dale	CRCW06031R0F-e3
C_{COMP}	330 pF, $\pm 5\%$, C0G, 50 V	0603	TDK	C1608C0G1H331J
C_{SS}	10 nF, $\pm 10\%$, X7R, 16 V	0603	Murata	GRM188R71C103KA01
C_F	1 μF , $\pm 10\%$, X7R, 10 V	0603	Murata	GRM188R71A105KA61

Table 7. LM2854 1-MHz Bill of Materials, $V_{IN} = 3.3\text{ V}$, $V_{OUT} = 0.8\text{ V}$, $I_{OUT(MAX)} = 4\text{ A}$, Optimized for Solution Size and Transient Response

REF DES	DESCRIPTION	CASE SIZE	MANUFACTURER	MANUFACTURER P/N
U1	Synchronous Buck Regulator	HTSSOP-16	Texas Instruments	LM2854MHX-1000
C_{IN}	47 μF , X5R, 6.3 V	1206	TDK	C3216X5R0J476M
C_O	47 μF , X5R, 6.3 V	1206	TDK	C3216X5R0J476M
L_O	0.47 μH , 14.5 m Ω , 7 A	4.06 × 4.45 × 2.00 mm	Vishay Dale	IHLP1616BZER0R47M11
R_{FB1}	110 k Ω	0402	Vishay Dale	CRCW04021103F-e3
R_{COMP}	1 k Ω	0402	Vishay Dale	CRCW04021001F-e3
R_F	1 Ω	0402	Vishay Dale	CRCW04021R0F-e3
C_{COMP}	27 pF, $\pm 5\%$, C0G, 50 V	0402	Murata	GRM1555C1H270JZ01
C_{SS}	10 nF, $\pm 10\%$, X7R, 16 V	0402	Murata	GRM155R71C103KA01
C_F	1 μF , $\pm 10\%$, X7R, 10 V	0402	Murata	GRM155R61A105KE15

9 Power Supply Recommendations

The LM2854 is designed to operate from an input voltage supply range from 2.95 V to 5.5 V. This input supply should be able to source the maximum input current and maintain a voltage above either 2.95 V or the output voltage, whichever is higher. In cases where input supply is located at a distance (more than a few inches) from the device, drop due to traces and wires must be considered.

10 Layout

10.1 Layout Guidelines

PC board layout is an important part of DC-DC converter design. Poor board layout can disrupt the performance of a DC-DC converter and surrounding circuitry by contributing to EMI, ground bounce and resistive voltage drop in the traces. These can send erroneous signals to the DC-DC converter resulting in poor regulation or instability. Good layout can be implemented by following a few simple design rules.

1. Minimize area of switched current loops.

There are two loops where currents are switched at high di/dt slew rates in a buck regulator. The first loop represents the path taken by AC current flowing during the high side PFET on time. This current flows from the input capacitor to the regulator PVIN pins, through the high side FET to the regulator SW pin, filter inductor, output capacitor and returning via the PCB ground plane to the input capacitor. The second loop represents the path taken by AC current flowing during the low side NFET on time. This current flows from the output capacitor ground to the regulator PGND pins, through the NFET to the inductor and output capacitor. From an EMI reduction standpoint, it is imperative to minimize this loop area during PC board layout by physically locating the input capacitor close to the LM2854. Specifically, it is advantageous to place C_{IN} as close as possible to the LM2854 PVIN and PGND pins. Grounding for both the input and output capacitor should consist of a localized top side plane that connects to PGND and the exposed die attach pad (DAP). The inductor should be placed close to the SW pin and output capacitor.

2. Minimize the copper area of the switch node.

The LM2854 has two SW pins optimally located on one side of the package. In general the SW pins should be connected to the filter inductor on the top PCB layer. The inductor should be placed close to the SW pins to minimize the copper area of the switch node.

3. Have a single point ground for all device analog grounds located under the DAP.

The ground connections for the Feedback, Soft-start, Enable and AVIN components should be routed to the AGND pin of the device. The AGND pin should connect to PGND under the DAP. This prevents any switched or load currents from flowing in the analog ground traces. If not properly handled, poor grounding can result in degraded load regulation or erratic switching behavior.

4. Minimize trace length to the FB pin.

Since the feedback (FB) node is high impedance, the trace from the output voltage setpoint resistor divider to FB pin should be as short as possible. This is most important as relatively high value resistors are used to set the output voltage. The FB trace should be routed away from the SW pin and inductor to avoid noise pickup from the SW pin. Both feedback resistors, R_{FB1} and R_{FB2} , and the compensation components, R_{COMP} and C_{COMP} , should be located close to the FB pin.

5. Make input and output bus connections as wide as possible.

This reduces any voltage drops on the input or output of the converter and maximizes efficiency. To optimize voltage accuracy at the load, ensure that a separate feedback voltage sense trace is made to the load. Doing so will correct for voltage drops and provide optimum output accuracy.

6. Provide adequate device heat-sinking.

Use an array of heat-sinking vias to connect the DAP to the ground plane on the bottom PCB layer. If the PCB has a plurality of copper layers, these thermal vias can also be employed to make connection to inner layer heat-spreading ground planes. For best results use a 5 x 3 via array with minimum via diameter of 10 mils. Ensure enough copper area is used to keep the junction temperature below 125°C.

Layout Guidelines (continued)

7. Keep sensitive system signals away from SW node.

SW is a high-voltage, rapidly changing signal which can couple to adjacent signal lines. Signal integrity of lines that have high impedances or are very sensitive to noise can be compromised by capacitive coupling to SW node.

10.2 Layout Example

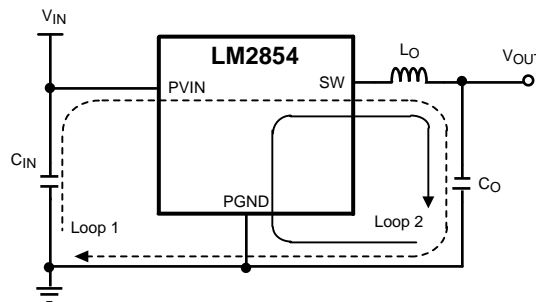

Figure 45. High Current Loops

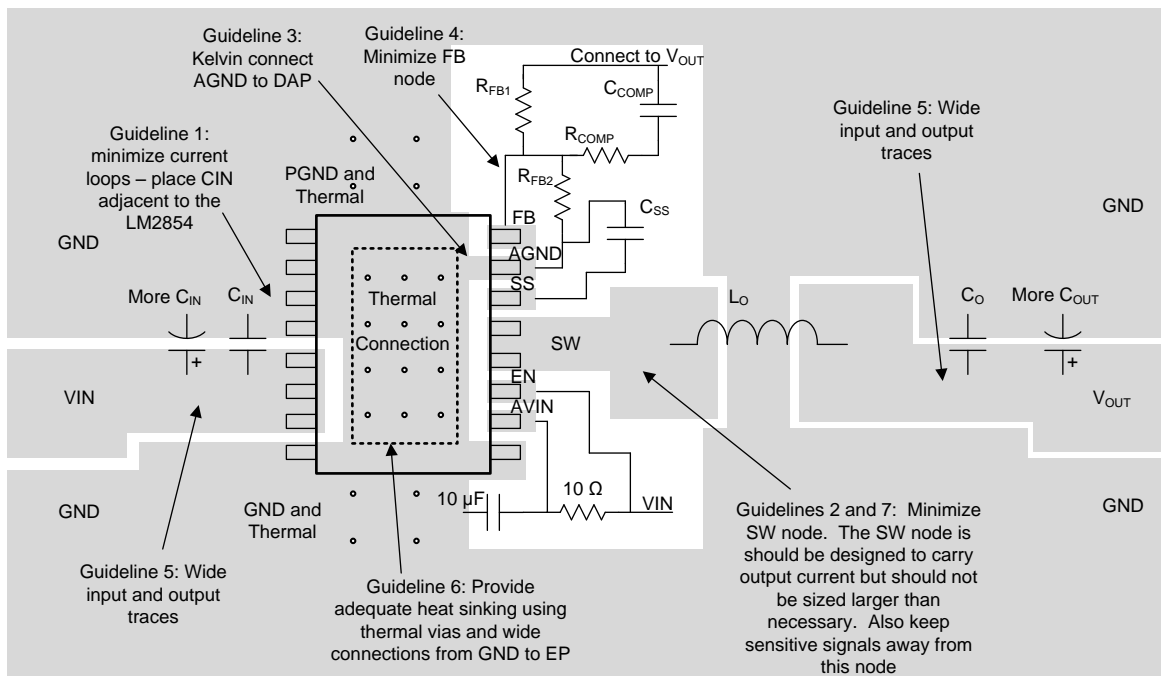

Figure 46. Recommended Layout for the LM2854

11 Device and Documentation Support

11.1 Documentation Support

11.1.1 Related Documentation

For related documentation, see the following:

- *AN-1786 LM2854 500 kHz Buck Regulator Evaluation Board* (Rev. B), [SNVA323](#)
- *AN-1880 LM2854 1MHz Buck Regulator Demo Board* (Rev. B), [SNVA358](#)
- *AN-1149 Layout Guidelines for Switching Power Supplies*, [SNVA021](#)
- *AN-1229 PCB Layout Guidelines*, [SNVA054](#)
- *Constructing Your Power Supply- Layout Considerations*, [SLUP230](#)
- *Low Radiated EMI Layout Made SIMPLE with LM4360x and LM4600x*, [SNVA721](#)
- *AN-2020 Thermal Design By Insight, Not Hindsight*, [SNVA419](#)
- *AN-1520 A Guide to Board Layout for Best Thermal Resistance for Exposed Pad Packages*, [SNVA183](#)
- *Semiconductor and IC Package Thermal Metrics*, [SPRA953](#)
- *Thermal Design made Simple with LM43603 and LM43602*, [SNVA719](#)
- *Using New Thermal Metrics*, [SBVA025](#)

11.2 Trademarks

PowerWise is a trademark of Texas Instruments, Inc.
All other trademarks are the property of their respective owners.

11.3 Electrostatic Discharge Caution



These devices have limited built-in ESD protection. The leads should be shorted together or the device placed in conductive foam during storage or handling to prevent electrostatic damage to the MOS gates.

11.4 Glossary

[SLYZ022](#) — *TI Glossary*.

This glossary lists and explains terms, acronyms, and definitions.

12 Mechanical, Packaging, and Orderable Information

The following pages include mechanical, packaging, and orderable information. This information is the most current data available for the designated devices. This data is subject to change without notice and revision of this document. For browser-based versions of this data sheet, refer to the left-hand navigation.

PACKAGING INFORMATION

Orderable Device	Status (1)	Package Type	Package Drawing	Pins	Package Qty	Eco Plan (2)	Lead/Ball Finish (6)	MSL Peak Temp (3)	Op Temp (°C)	Device Marking (4/5)	Samples
LM2854MH-1000	NRND	HTSSOP	PWP	16	92	TBD	Call TI	Call TI	-40 to 85	LM2854 -1000	
LM2854MH-1000/NOPB	ACTIVE	HTSSOP	PWP	16	92	Green (RoHS & no Sb/Br)	CU SN	Level-1-260C-UNLIM	-40 to 85	LM2854 -1000	Samples
LM2854MH-500/NOPB	ACTIVE	HTSSOP	PWP	16	92	Green (RoHS & no Sb/Br)	CU SN	Level-1-260C-UNLIM	-40 to 85	LM2854 -500	Samples
LM2854MHX-1000/NOPB	ACTIVE	HTSSOP	PWP	16	2500	Green (RoHS & no Sb/Br)	CU SN	Level-1-260C-UNLIM	-40 to 85	LM2854 -1000	Samples
LM2854MHX-500/NOPB	ACTIVE	HTSSOP	PWP	16	2500	Green (RoHS & no Sb/Br)	CU SN	Level-1-260C-UNLIM	-40 to 85	LM2854 -500	Samples

(1) The marketing status values are defined as follows:

ACTIVE: Product device recommended for new designs.

LIFEBUY: TI has announced that the device will be discontinued, and a lifetime-buy period is in effect.

NRND: Not recommended for new designs. Device is in production to support existing customers, but TI does not recommend using this part in a new design.

PREVIEW: Device has been announced but is not in production. Samples may or may not be available.

OBSOLETE: TI has discontinued the production of the device.

(2) **RoHS:** TI defines "RoHS" to mean semiconductor products that are compliant with the current EU RoHS requirements for all 10 RoHS substances, including the requirement that RoHS substance do not exceed 0.1% by weight in homogeneous materials. Where designed to be soldered at high temperatures, "RoHS" products are suitable for use in specified lead-free processes. TI may reference these types of products as "Pb-Free".

RoHS Exempt: TI defines "RoHS Exempt" to mean products that contain lead but are compliant with EU RoHS pursuant to a specific EU RoHS exemption.

Green: TI defines "Green" to mean the content of Chlorine (Cl) and Bromine (Br) based flame retardants meet JS709B low halogen requirements of <=1000ppm threshold. Antimony trioxide based flame retardants must also meet the <=1000ppm threshold requirement.

(3) MSL, Peak Temp. - The Moisture Sensitivity Level rating according to the JEDEC industry standard classifications, and peak solder temperature.

(4) There may be additional marking, which relates to the logo, the lot trace code information, or the environmental category on the device.

(5) Multiple Device Markings will be inside parentheses. Only one Device Marking contained in parentheses and separated by a "-" will appear on a device. If a line is indented then it is a continuation of the previous line and the two combined represent the entire Device Marking for that device.

(6) Lead/Ball Finish - Orderable Devices may have multiple material finish options. Finish options are separated by a vertical ruled line. Lead/Ball Finish values may wrap to two lines if the finish value exceeds the maximum column width.

Important Information and Disclaimer: The information provided on this page represents TI's knowledge and belief as of the date that it is provided. TI bases its knowledge and belief on information provided by third parties, and makes no representation or warranty as to the accuracy of such information. Efforts are underway to better integrate information from third parties. TI has taken and continues to take reasonable steps to provide representative and accurate information but may not have conducted destructive testing or chemical analysis on incoming materials and chemicals. TI and TI suppliers consider certain information to be proprietary, and thus CAS numbers and other limited information may not be available for release.

In no event shall TI's liability arising out of such information exceed the total purchase price of the TI part(s) at issue in this document sold by TI to Customer on an annual basis.

TAPE AND REEL INFORMATION



QUADRANT ASSIGNMENTS FOR PIN 1 ORIENTATION IN TAPE



*All dimensions are nominal

Device	Package Type	Package Drawing	Pins	SPQ	Reel Diameter (mm)	Reel Width W1 (mm)	A0 (mm)	B0 (mm)	K0 (mm)	P1 (mm)	W (mm)	Pin1 Quadrant
LM2854MHX-1000/NOPB	HTSSOP	PWP	16	2500	330.0	12.4	6.95	5.6	1.6	8.0	12.0	Q1
LM2854MHX-500/NOPB	HTSSOP	PWP	16	2500	330.0	12.4	6.95	5.6	1.6	8.0	12.0	Q1

TAPE AND REEL BOX DIMENSIONS

*All dimensions are nominal

Device	Package Type	Package Drawing	Pins	SPQ	Length (mm)	Width (mm)	Height (mm)
LM2854MHX-1000/NOPB	HTSSOP	PWP	16	2500	367.0	367.0	35.0
LM2854MHX-500/NOPB	HTSSOP	PWP	16	2500	367.0	367.0	35.0

EXAMPLE BOARD LAYOUT

PWP0016A

PowerPAD™ HTSSOP - 1.2 mm max height

PLASTIC SMALL OUTLINE

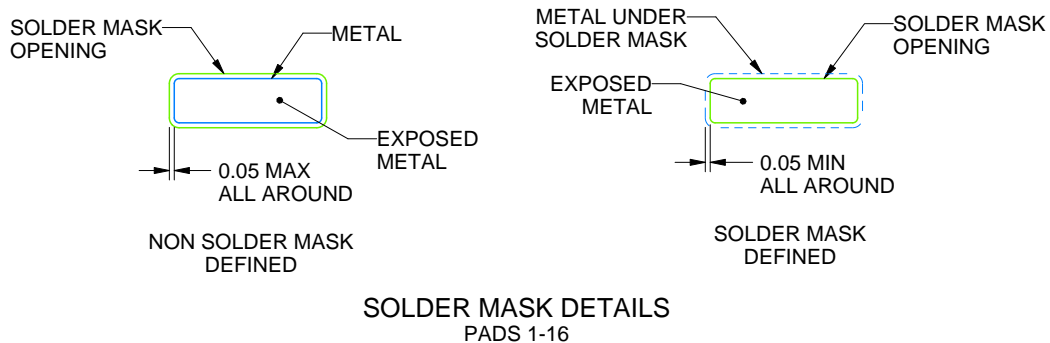
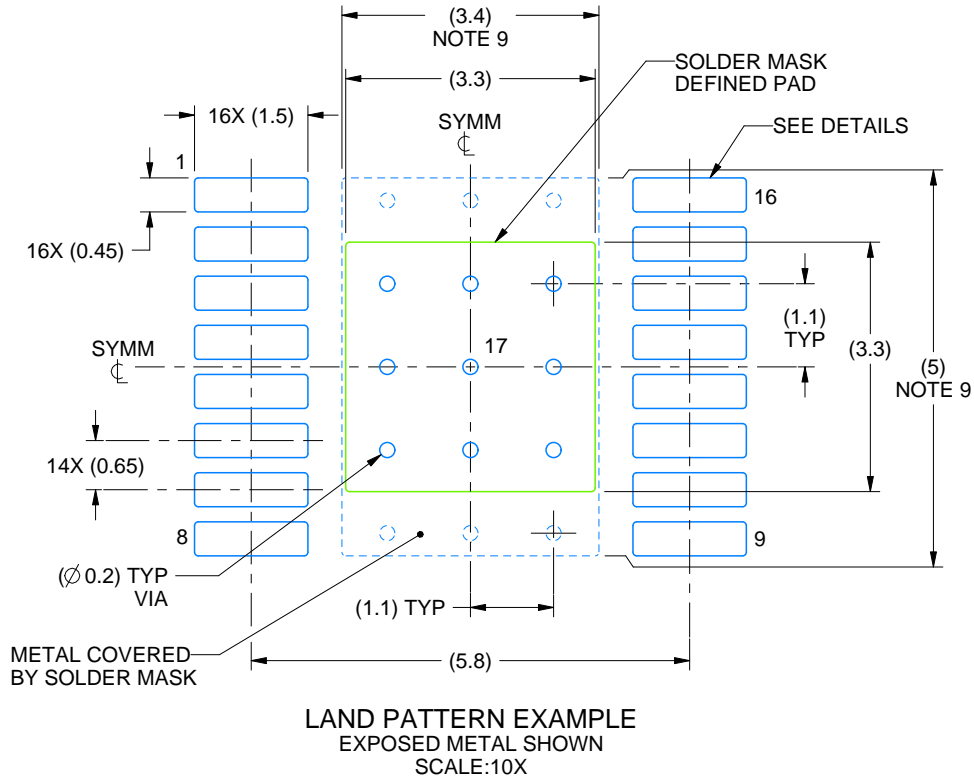

4214868/A 02/2017

NOTES: (continued)

6. Publication IPC-7351 may have alternate designs.
7. Solder mask tolerances between and around signal pads can vary based on board fabrication site.
8. This package is designed to be soldered to a thermal pad on the board. For more information, see Texas Instruments literature numbers SLMA002 (www.ti.com/lit/slma002) and SLMA004 (www.ti.com/lit/slma004).
9. Size of metal pad may vary due to creepage requirement.

EXAMPLE STENCIL DESIGN

PWP0016A

PowerPAD™ HTSSOP - 1.2 mm max height

PLASTIC SMALL OUTLINE

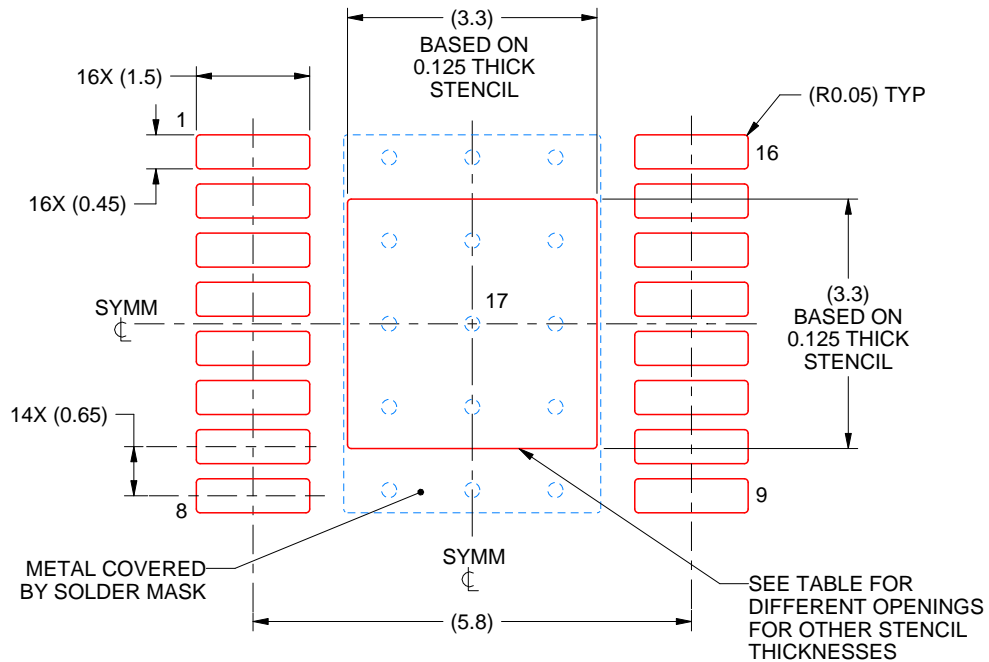

SOLDER PASTE EXAMPLE
 EXPOSED PAD
 100% PRINTED SOLDER COVERAGE BY AREA
 SCALE:10X

STENCIL THICKNESS	SOLDER STENCIL OPENING
0.1	3.69 X 3.69
0.125	3.3 X 3.3 (SHOWN)
0.15	3.01 X 3.01
0.175	2.79 X 2.79

4214868/A 02/2017

NOTES: (continued)

10. Laser cutting apertures with trapezoidal walls and rounded corners may offer better paste release. IPC-7525 may have alternate design recommendations.
11. Board assembly site may have different recommendations for stencil design.

IMPORTANT NOTICE AND DISCLAIMER

TI PROVIDES TECHNICAL AND RELIABILITY DATA (INCLUDING DATASHEETS), DESIGN RESOURCES (INCLUDING REFERENCE DESIGNS), APPLICATION OR OTHER DESIGN ADVICE, WEB TOOLS, SAFETY INFORMATION, AND OTHER RESOURCES "AS IS" AND WITH ALL FAULTS, AND DISCLAIMS ALL WARRANTIES, EXPRESS AND IMPLIED, INCLUDING WITHOUT LIMITATION ANY IMPLIED WARRANTIES OF MERCHANTABILITY, FITNESS FOR A PARTICULAR PURPOSE OR NON-INFRINGEMENT OF THIRD PARTY INTELLECTUAL PROPERTY RIGHTS.



These resources are intended for skilled developers designing with TI products. You are solely responsible for (1) selecting the appropriate TI products for your application, (2) designing, validating and testing your application, and (3) ensuring your application meets applicable standards, and any other safety, security, or other requirements. These resources are subject to change without notice. TI grants you permission to use these resources only for development of an application that uses the TI products described in the resource. Other reproduction and display of these resources is prohibited. No license is granted to any other TI intellectual property right or to any third party intellectual property right. TI disclaims responsibility for, and you will fully indemnify TI and its representatives against, any claims, damages, costs, losses, and liabilities arising out of your use of these resources.

TI's products are provided subject to TI's Terms of Sale (www.ti.com/legal/termsofsale.html) or other applicable terms available either on ti.com or provided in conjunction with such TI products. TI's provision of these resources does not expand or otherwise alter TI's applicable warranties or warranty disclaimers for TI products.

Mailing Address: Texas Instruments, Post Office Box 655303, Dallas, Texas 75265
Copyright © 2019, Texas Instruments Incorporated

Looking for pricing, stock, or lifecycle information?

Click below to explore more details on WIN SOURCE:

-  [View LM2854MH-500/NOPB on WIN SOURCE](#)
-  [Texas Instruments](#) Information

Optimize Your Supply Chain with WIN SOURCE Solutions

-  Global Sourcing Solution
-  Obsolete Management
-  Cost Control Management
-  Shortage Management
-  Alternative Solution
-  Excess Inventory Management