





**THE DATASHEET OF
S8050**



SPECIFICATION SHEET

SPECIFICATION SHEET NO.	P0610- SOT23S8050SJ3Y
DATE	June 10, 2022
REVISION	A0
DESCRIPTION	SMD Plastic-Encapsulate Transistors, SOT-23 series, 3 pads S8050 Type, NPN Collector-Emitter Voltage 25V. Collector Current 500mA Max. Operating Temp. Range -55°C ~+150°C, Package in Tape/Reel, 3000pcs/Reel RoHS/RoHS III compliant
CUSTOMER	
CUSTOMER PART NUMBER	
CROSS REF. PART NUMBER	
ORIGINAL PART NUMBER	MDD S8050
PART CODE	SOT23S8050SJ3Y

VENDOR APPROVE			
Issued/Checked/Approved			
DATE: June 10, 2022			

CUSTOMER APPROVE	
DATE:	

6/13/2022

SMD PLASTIC-ENCAPULATE TRANSISTORS SOT23 SERIES

MAIN FEATURE

- Complementary To S8550
- Collector Current: $I_c=0.5A$



APPLICATION

- For PCB Application

RFQ

[Request For Quotation](#)

PART CODE GUIDE

SOT23	S8050	S	J3Y
1	2	3	4

1) **SOT23**: SMD Plastic-Encapsulate Transistors, 3 pads SOT-23 series Code

2) **S8050**: Type code for S8050 Type

3) **S**: Package code, Package in Tape/Reel, 3000pcs/Reel

4) **J3Y**: Marking code for "J3Y" on the case surface, Different Marking for different specification

SMD PLASTIC-ENCAPULATE TRANSISTORS SOT23 SERIES

DIMENSION (Unit: Inch/mm)

Image for reference

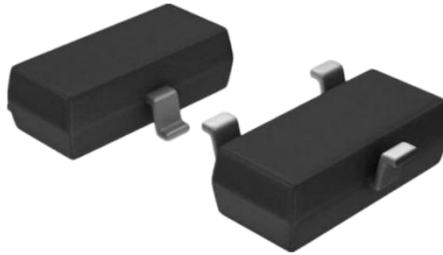

Marking: J3Y

SOT-23

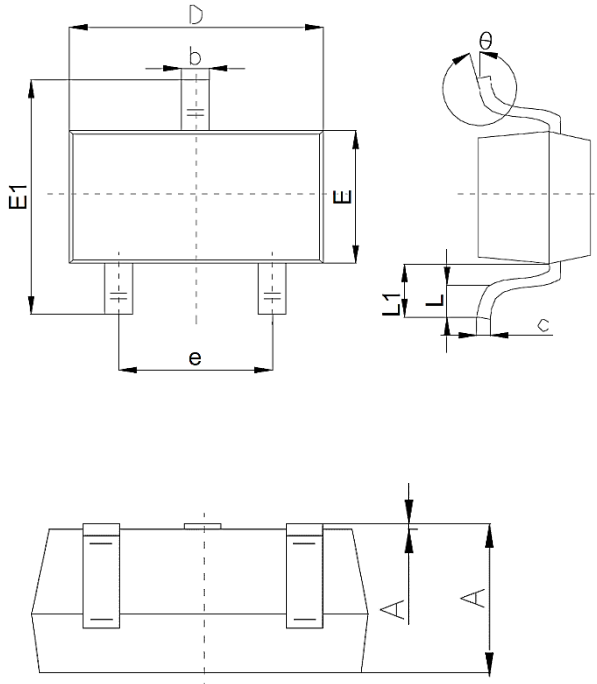

Symbol	Value (mm)		
	Min.	Typ.	Max.
A	0.90		1.40
A1			0.10
b	0.30		0.50
c	0.08		0.20
D	2.80	2.90	3.10
E	1.20		1.60
E1	2.25		2.80
e	1.80	1.90	2.00
L	0.10		0.50
L1	0.40		0.55
θ	0°		10°

Recommend Pad Layout

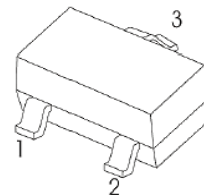
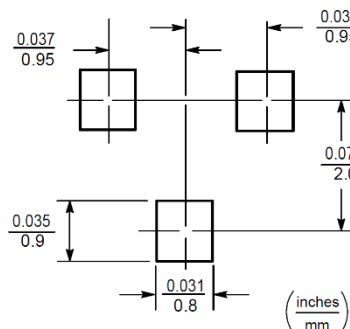

- 1.Base
- 2.Emmitter
- 3.Collector

SMD PLASTIC-ENCAPULATE TRANSISTORS SOT23 SERIES

MECHANICAL DATA

Case	Terminals	Polarity	Mounting Position	Weight per piece
JEDEC SOT-23 molded plastic body	Solder plated, Solderable per MIL-STD-750, Method 2026	Polarity symbol marking on case	Any	0.00019 Ounce, 0.00591 grams

MAX. RATINGS AT Ta=25 °C

Parameter	SYMBOLS	VALUE	UNITS
		LIMIT	
Collector-base Voltage	V _{CBO}	40	Volts
Collector-emitter Voltage	V _{CEO}	25	Volts
Emitter-base Voltage	V _{EBO}	5	Volts
Collector Current - Continuous	I _C	500	mA
Collector Power Dissipation	P _C	300	mW
Thermal Resistance From Junction To Ambient	R _{θJA}	417	°C/W
Junction Temperature	T _J	+150	°C
Storage Temperature Range	T _{STG}	-55 ~ +150	°C

SMD PLASTIC-ENCAPULATE TRANSISTORS SOT23 SERIES
ELECTRICAL CHARACTERISTICS AT Ta= 25 °C

Parameter	SYMBOLS	VALUE			UNIT	Condition
		Min.	Typ.	Max.		
Collector-base Breakdown Voltage	V _{CBO}	40			V	I _c = 100 μA, I _E =0
Collector-emitter Breakdown Voltage	V _{CEO}	25			V	I _c = 1mA, I _B =0
Emitter-base Breakdown Voltage	V _{EBO}	5			V	I _E = 100 μA, I _C =0
Collector Cut-off Current	I _{CBO}			0.1	μA	V _{CB} = 40V, I _E =0
Collector Cut-off Current	I _{CEO}			0.1	μA	V _{CB} = 20V, I _E =0
Emitter Cut-off Current	I _{EBO}			0.1	μA	V _{EB} = 5V, I _C =0
DC Current Gain	h _{FE(1)}	120		400		V _{CE} =1V, I _C =50mA
	h _{FE(1)}	50				V _{CE} =1V, I _C =500mA
Collector-emitter Saturation Voltage	V _{CE(sat)}			0.6	V	I _C =500mA, I _B =50mA
Base-emitter Saturation Voltage	V _{BE(sat)}			1.2	V	I _C =500mA, I _B =50 mA
Transition Frequency	f _T	150			MHz	V _{CE} =6V, I _C = 20mA f= 30 MHz

CLASSIFICATION OF Hfe (1)

Rank	L	H	J
Range	120 ~ 200	200 ~ 350	300~400

SMD PLASTIC-ENCAPULATE TRANSISTORS SOT23 SERIES
RELIABILITY

Number	Experiment Items	Experiment Method And Conditions	Reference Documents
1	Solder Resistance Test	Test 260°C± 5°C for 10 ± 2 sec. Immerse body into solder 1/16" ± 1/32"	MIL-STD-750D METHOD-2031.2
2	Solderability Test	230°C ±5°C for 5 sec.	MIL-STD-750D METHOD-2026.1 0
3	Pull Test	1 kg in axial lead direction for 10 sec.	MIL-STD-750D METHOD-2036.4
4	Bend Test	0.5Kg Weight Applied To Each Lead, Bending Arcs 90 °C ± 5 °C For 3 Times	MIL-STD-750D METHOD-2036.4
5	High Temperature Reverse Bias Test	TA=100°C for 1000 Hours at VR=80% Rated VR	MIL-STD-750D METHOD-1038.4
6	Forward Operation Life Test	TA=25°C Rated Average Rectified Current	MIL-STD-750D METHOD-1027.3
7	Intermittent Operation Life Test	On state: 5 min with rated IRMS Power Off state: 5 min with Cool Forced Air. On and off for 1000 cycles.	MIL-STD-750D METHOD-1036.3
8	Pressure Cooker Test	15 PSIG, TA=121°C, 4 hours	MIL-S-19500 APPENOIXC
9	Temperature Cycling Test	-55°C~+125°C; 30 Minutes For Dwelled Time 5 minutes for transferred time. Total: 10 cycles.	MIL-STD-750D METHOD-1051.7
10	Thermal Shock Test	0°C for 5 minutes., 100°C for 5minutes, Total: 10 cycles	MIL-STD-750D METHOD-1056.7
11	Forward Surge Test	8.3ms Single Sale Sine-wave One Surge.	MIL-STD-750D METHOD-4066.4
12	Humidity Test	TA=65°C, RH=98% for 1000 hours.	MIL-STD-750D METHOD-1021.3
13	High Temperature Storage life Test	150°C for 1000 Hours	MIL-STD-750D METHOD-1031.5

SMD PLASTIC-ENCAPULATE TRANSISTORS SOT23 SERIES

SUGGESTED REFLOW PROFILE (For Reference Only)

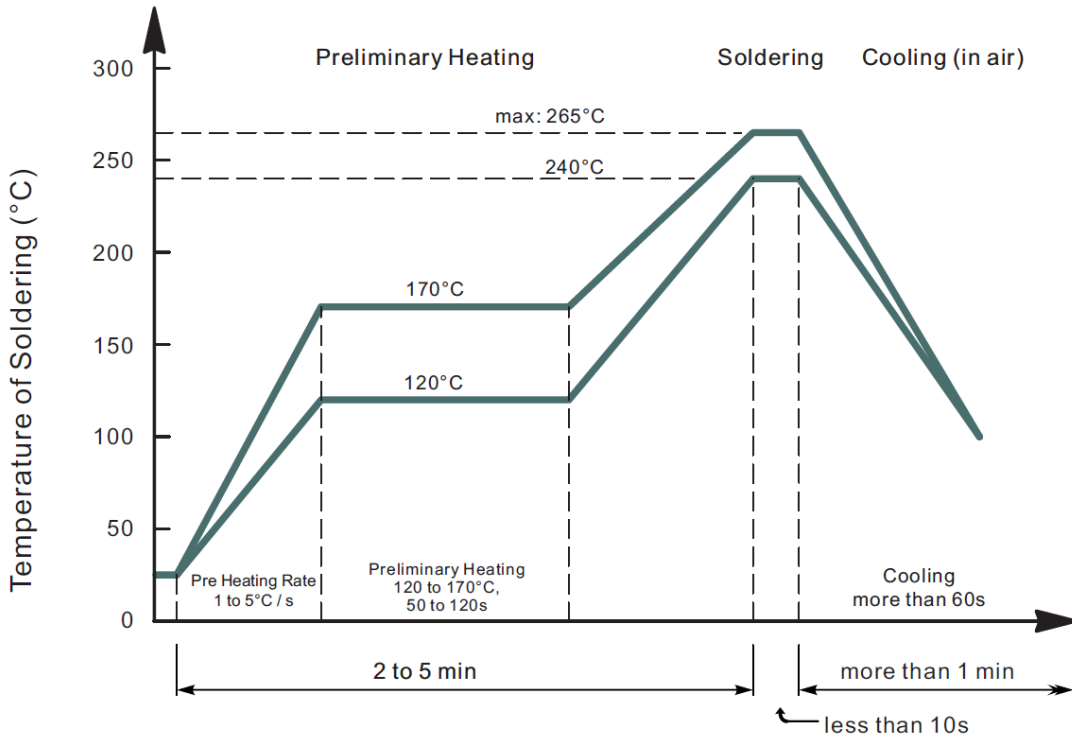

- Recommended peak temperature is over 245°C, If peak temperature is below 245 °C, you may adjust the following parameters; time length of peak temperature (longer), time length of soldering (longer), thickness of solder paste (thicker)
- Welding shall not exceed 2 times
- Remark: lead free solder paste (96.5 sn/3.0 Ag/0.5Cu)

SMD PLASTIC-ENCAPULATE TRANSISTORS SOT23 SERIES

RATINGS AND CHARACTERISTIC CURVES (For Reference Only)

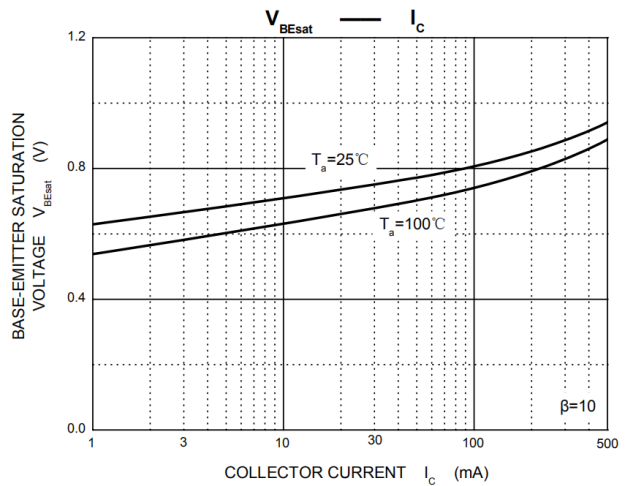
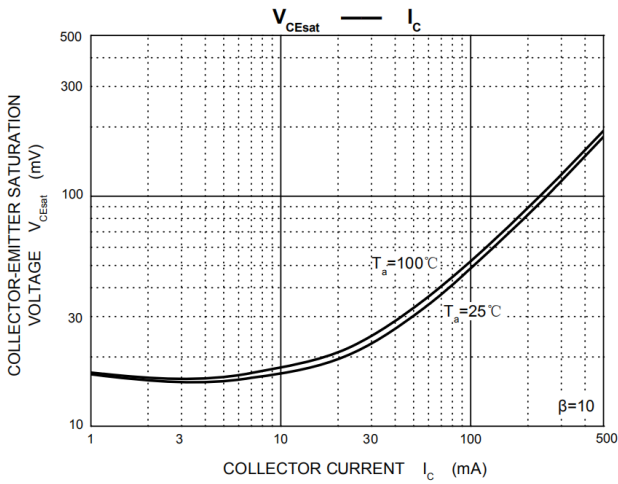
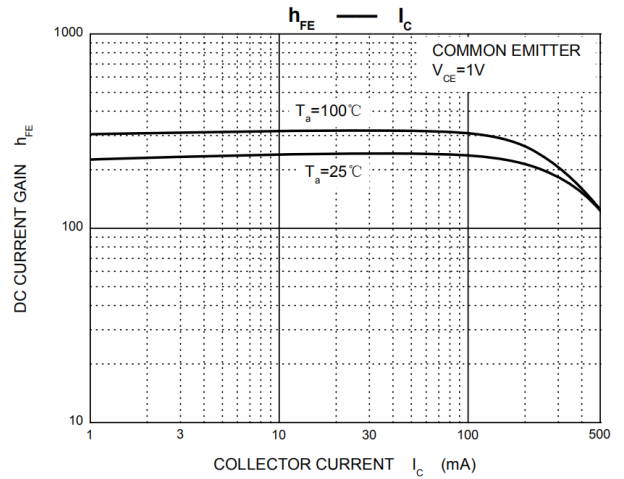
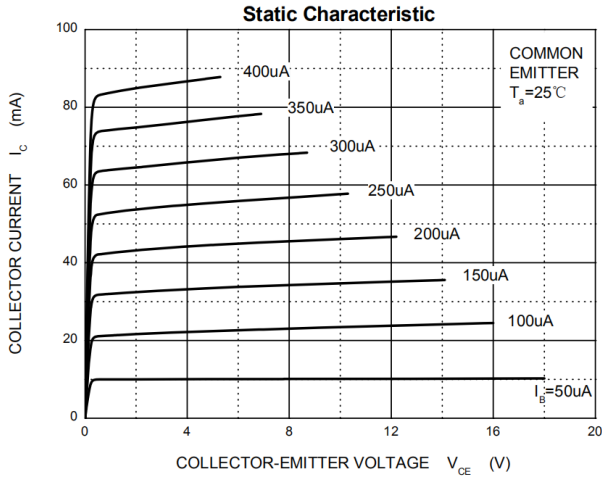

SMD PLASTIC-ENCAPULATE TRANSISTORS SOT23 SERIES

RATINGS AND CHARACTERISTIC CURVES (For Reference Only)

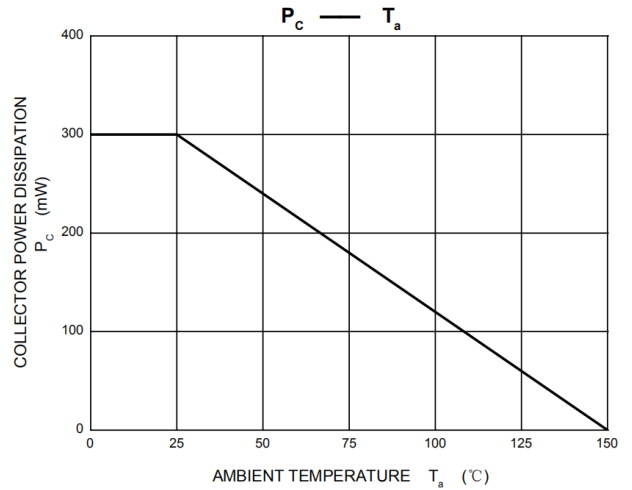
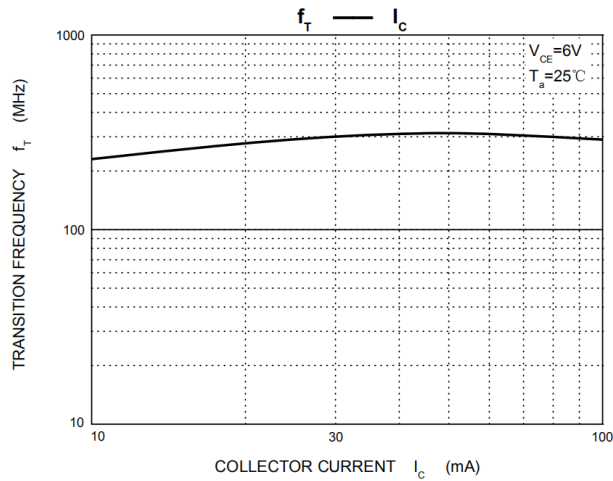
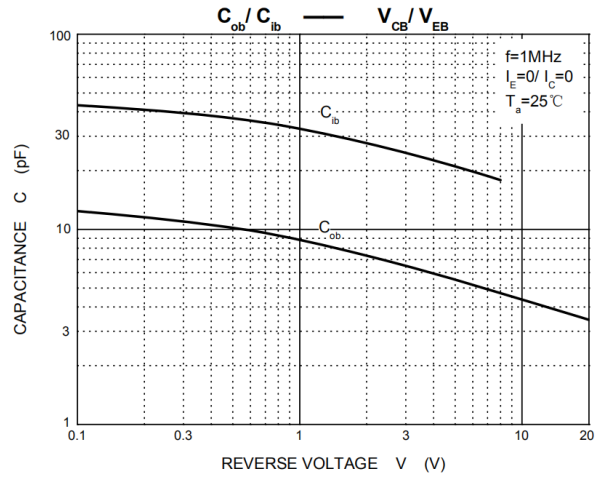
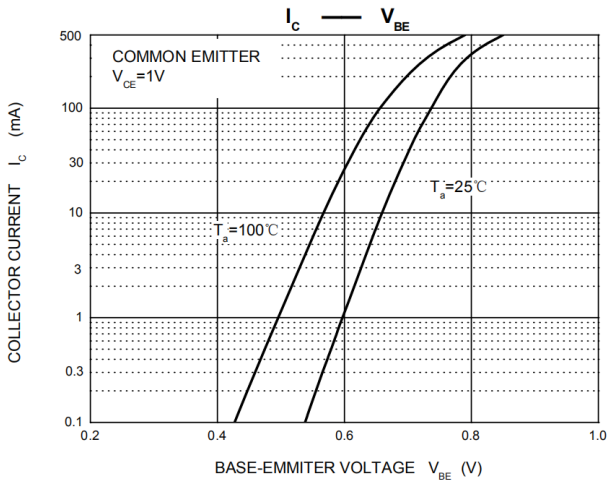

SMD PLASTIC-ENCAPULATE TRANSISTORS SOT23 SERIES
TAPE/REEL (Unit: mm)

All Devices are packed in accordance with EIA standard RS-481-A and specifications.

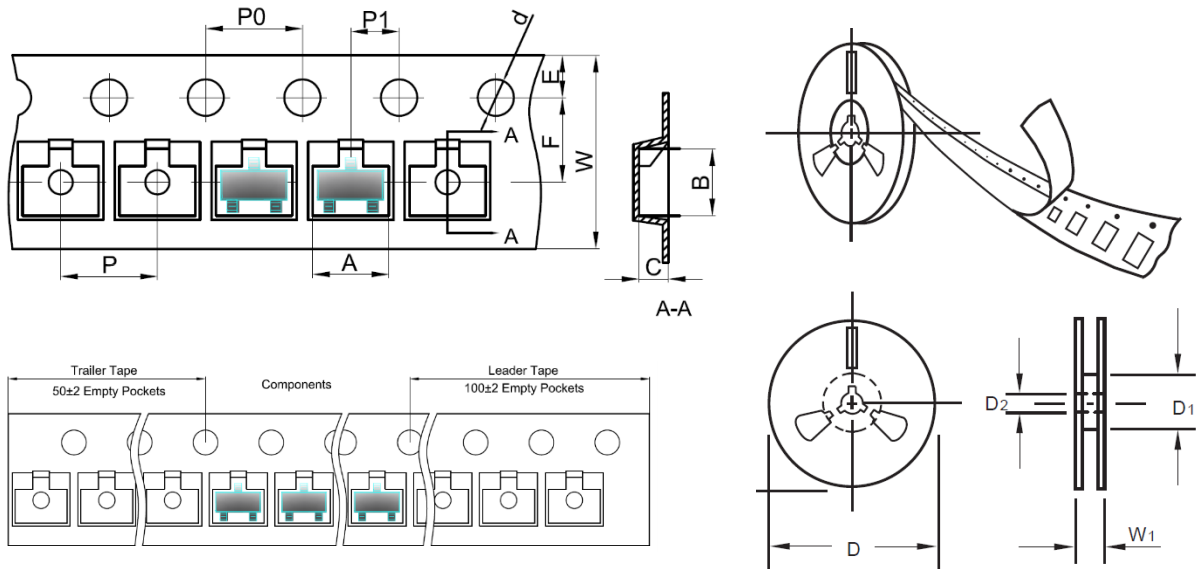

Item	Symbol	Tolerance	SOT-23
Carrier width	A	0.1	3.15
Carrier Length	B	0.1	2.77
Carrier Depth	C	0.1	1.22
Sprocket hole	d	0.05	1.55
7"Reel outside diameter	D	2.0	178.00
7"Reel inner diameter	D1	Min.	54.4
Feed hole diameter	D2	0.5	13.00
Sprocket hole position	E	0.1	1.75
Punch hole position	F	0.1	3.50
Punch hole pitch	P	0.1	4.00
Sprocket hole pitch	P0	0.1	4.00
Embossment center	P1	0.1	2.00
Overall tape thickness	T	0.1	0.25
Tape width	W	0.3	8.00
Reel width	W1	1.0	19.50

SMD PLASTIC-ENCAPULATE TRANSISTORS SOT23 SERIES

PACKAGE



Case Code	SOT-23
Reel Size	7"
Reel Size	178 mm
MPQ/Reel	3000 pcs
Qty. /Box	6000 pcs
G.W/Box	1 LBS

DISCLAIMER







NextGen Component, Inc. reserves the right to make changes to the product(s) and or information contained herein without notice. No liability is assumed as a result of their use or application. No rights under any patent accompany the sale of any such product(s) or information

Looking for pricing, stock, or lifecycle information?

Click below to explore more details on WIN SOURCE:

-  [View S8050 on WIN SOURCE](#)
-  [MDD Information](#)

Optimize Your Supply Chain with WIN SOURCE Solutions

-  Global Sourcing Solution
-  Obsolete Management
-  Cost Control Management
-  Shortage Management
-  Alternative Solution
-  Excess Inventory Management