



**THE DATASHEET OF
DDTC114YE-7**



Features

- Epitaxial Planar Die Construction
- Complementary PNP Types Available (DDTA)
- Built-In Biasing Resistors, R1≠R2
- **Lead Free/RoHS Compliant (Note 2)**
- **"Green" Device (Note 3 and 4)**

Mechanical Data

- Case: SOT-523
- Case Material: Molded Plastic. UL Flammability Classification Rating 94V-0
- Moisture Sensitivity: Level 1 per J-STD-020C
- Terminals: Solderable per MIL-STD-202, Method 208
- Lead Free Plating (Matte Tin Finish annealed over Alloy 42 leadframe)
- Terminal Connections: See Diagram
- Marking & Date Code Information: See Table Below & Page 4
- Ordering Information: See Page 4
- Weight: 0.002 grams (approximate)

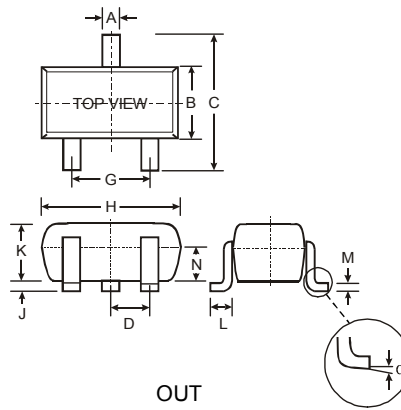

| SOT-523 | | | |
|---------|------|------|------|
| Dim | Min | Max | Typ |
| A | 0.15 | 0.30 | 0.22 |
| B | 0.75 | 0.85 | 0.80 |
| C | 1.45 | 1.75 | 1.60 |
| D | — | — | 0.50 |
| G | 0.90 | 1.10 | 1.00 |
| H | 1.50 | 1.70 | 1.60 |
| J | 0.00 | 0.10 | 0.05 |
| K | 0.60 | 0.80 | 0.75 |
| L | 0.10 | 0.30 | 0.22 |
| M | 0.10 | 0.20 | 0.12 |
| N | 0.45 | 0.65 | 0.50 |
| α | 0° | 8° | — |

All Dimensions in mm

| P/N | R1 (NOM) | R2 (NOM) | Marking |
|-----------|----------|----------|---------|
| DDTC113ZE | 1KΩ | 10KΩ | N02 |
| DDTC123YE | 2.2KΩ | 10KΩ | N05 |
| DDTC123JE | 2.2KΩ | 47KΩ | N06 |
| DDTC143XE | 4.7KΩ | 10KΩ | N09 |
| DDTC143FE | 4.7KΩ | 22KΩ | N10 |
| DDTC143ZE | 4.7KΩ | 47KΩ | N11 |
| DDTC114YE | 10KΩ | 47KΩ | N14 |
| DDTC114WE | 10KΩ | 4.7KΩ | N15 |
| DDTC124XE | 22KΩ | 47KΩ | N18 |
| DDTC144VE | 47KΩ | 10KΩ | N21 |
| DDTC144WE | 47KΩ | 22KΩ | N22 |

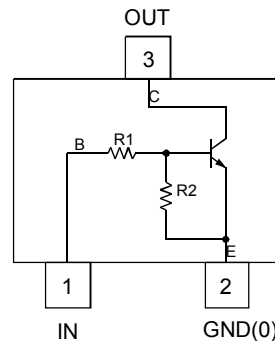

Schematic and Pin Configuration

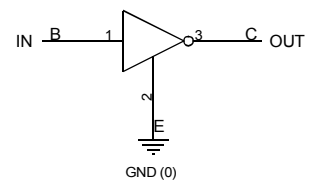

Equivalent Inverter Circuit

Maximum Ratings @T_A = 25°C unless otherwise specified

| Characteristic | Symbol | Value | Unit |
|---------------------------|----------------------|---|------|
| Supply Voltage (3) to (2) | V _{CC} | 50 | V |
| Input Voltage, (1) to (2) | V _{IN} | DDTC113ZE -5 to +10 DDTC123YE -5 to +12 DDTC123JE -5 to +12 DDTC143XE -7 to +20 DDTC143FE -6 to +30 DDTC143ZE -5 to +30 DDTC114YE -6 to +40 DDTC114WE -10 to +30 DDTC124XE -10 to +40 DDTC144VE -15 to +40 DDTC144WE -10 to +40 | V |
| Output Current | I _O | DDTC113ZE 100 DDTC123YE 100 DDTC123JE 100 DDTC143XE 100 DDTC143FE 100 DDTC143ZE 100 DDTC114YE 70 DDTC114WE 100 DDTC124XE 50 DDTC144VE 30 DDTC144WE 30 | mA |
| Output Current | I _C (Max) | 100 | mA |

- Notes:
1. Mounted on FR4 PC Board with recommended pad layout at <http://www.diodes.com/datasheets/ap02001.pdf>.
 2. No purposefully added lead.
 3. Diodes Inc.'s "Green" policy can be found on our website at http://www.diodes.com/products/lead_free/index.php.
 4. Product manufactured with Date Code UO (week 40, 2007) and newer are built with Green Molding Compound. Product manufactured prior to Date Code UO are built with Non-Green Molding Compound and may contain Halogens or Sb2O3 Fire Retardants.

Thermal Characteristics @_{T_A} = 25°C unless otherwise specified

| Characteristic | Symbol | Value | Unit |
|--|-----------------------------------|-------------|------|
| Power Dissipation | P _d | 150 | mW |
| Thermal Resistance, Junction to Ambient Air (Note 1) | R _{θJA} | 833 | °C/W |
| Operating and Storage Temperature Range | T _j , T _{STG} | -55 to +150 | °C |

Electrical Characteristics @_{T_A} = 25°C unless otherwise specified

| Characteristic | Symbol | Min | Typ | Max | Unit | Test Condition |
|----------------------------|---------------------------------|-----------|-----|-----|------|---|
| Input Voltage | V _{I(off)} | 0.3 | — | — | V | V _{CC} = 5V, I _O = 100μA |
| | | DDTC113ZE | | | | |
| DDTC123YE | | | | | | |
| DDTC123JE | | | | | | |
| DDTC143XE | | | | | | |
| DDTC143FE | | | | | | |
| DDTC143ZE | | | | | | |
| DDTC114YE | | | | | | |
| DDTC114WE | | | | | | |
| DDTC124XE | | | | | | |
| DDTC144VE | | | | | | |
| DDTC144WE | | | | | | |
| Input Voltage | V _{I(on)} | — | — | 3.0 | V | V _O = 0.3V, I _O = 20mA |
| | | DDTC113ZE | | | | |
| | | DDTC123YE | | | | |
| | | DDTC123JE | | | | |
| | | DDTC143XE | | | | |
| | | DDTC143FE | | | | |
| | | DDTC143ZE | | | | |
| | | DDTC114YE | | | | |
| | | DDTC114WE | | | | |
| | | DDTC124XE | | | | |
| DDTC144VE | | | | | | |
| DDTC144WE | | | | | | |
| Output Voltage | V _{O(on)} | — | 0.1 | 0.3 | V | I _O /I _I = 5mA/0.25mA DDTC123JE I _O /I _I = 5mA/0.25mA DDTC143ZE I _O /I _I = 5mA/0.25mA DDTC114YE I _O /I _I = 10mA/0.5mA All Others |
| Input Current | I _I | — | — | 7.2 | mA | V _I = 5V |
| | | DDTC113ZE | | | | |
| | | DDTC123YE | | | | |
| | | DDTC123JE | | | | |
| | | DDTC143XE | | | | |
| | | DDTC143FE | | | | |
| | | DDTC143ZE | | | | |
| | | DDTC114YE | | | | |
| | | DDTC114WE | | | | |
| | | DDTC124XE | | | | |
| DDTC144VE | | | | | | |
| DDTC144WE | | | | | | |
| Output Current | I _{O(off)} | — | — | 0.5 | μA | V _{CC} = 50V, V _I = 0V |
| DC Current Gain | G _I | 33 | — | — | — | V _O = 5V, I _O = 5mA |
| | | DDTC113ZE | | | | |
| | | DDTC123YE | | | | |
| | | DDTC123JE | | | | |
| | | DDTC143XE | | | | |
| | | DDTC143FE | | | | |
| | | DDTC143ZE | | | | |
| | | DDTC114YE | | | | |
| | | DDTC114WE | | | | |
| | | DDTC124XE | | | | |
| DDTC144VE | | | | | | |
| DDTC144WE | | | | | | |
| Input Resistor Tolerance | ΔR ₁ | -30 | — | +30 | % | — |
| Resistance Ratio Tolerance | ΔR ₂ /R ₁ | -20 | — | +20 | % | — |
| Gain-Bandwidth Product* | f _T | — | 250 | — | MHz | V _{CE} = 10V, I _E = 5mA, f = 100MHz |

* Transistor – For Reference Only

TYPICAL CURVES – DDTC123JE

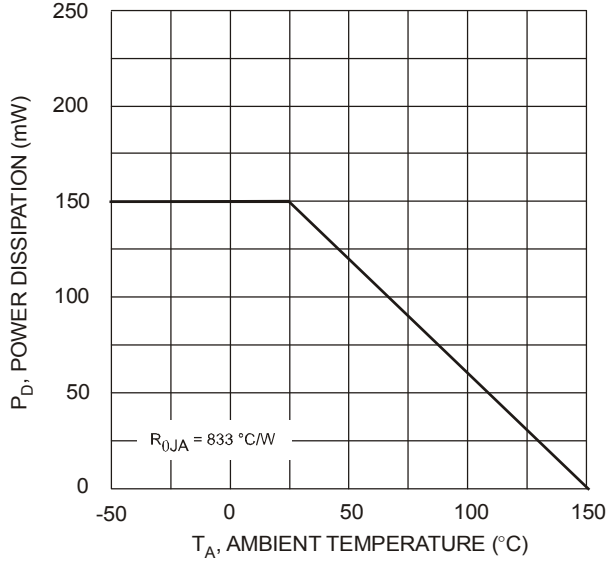

Fig. 1 Derating Curve

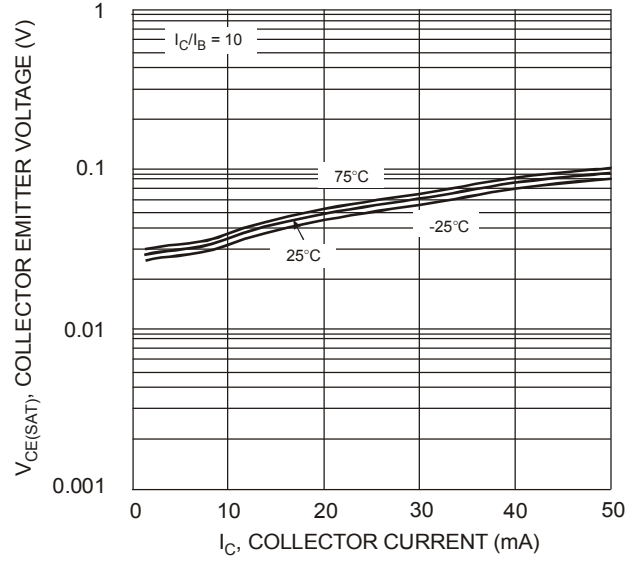

Fig. 2 $V_{CE(SAT)}$ vs. I_C

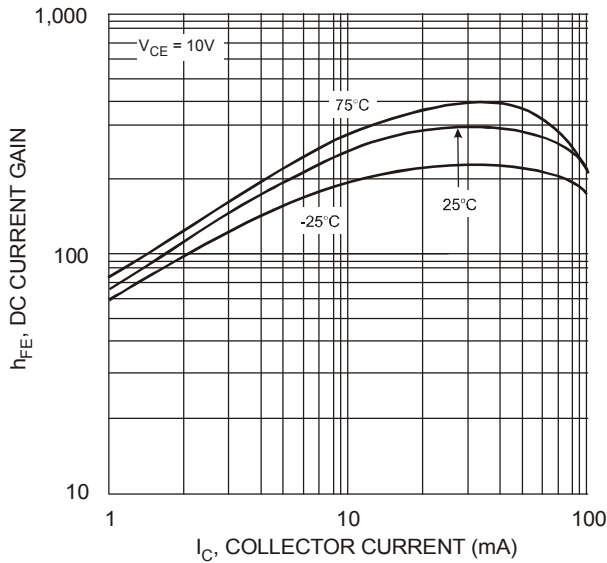

Fig. 3 DC Current Gain

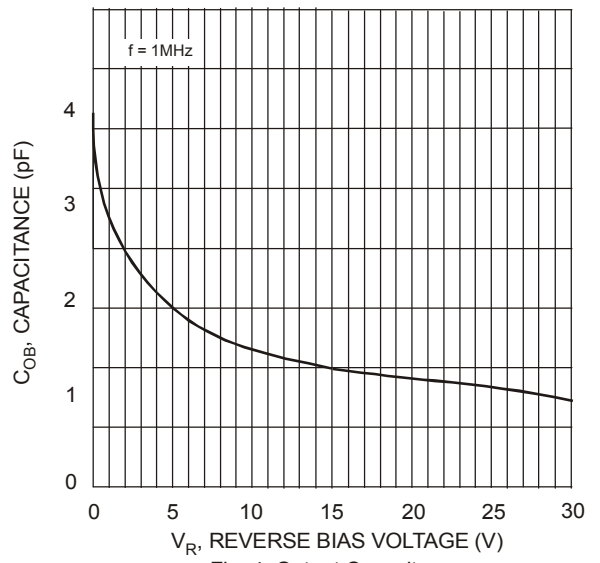

Fig. 4 Output Capacitance

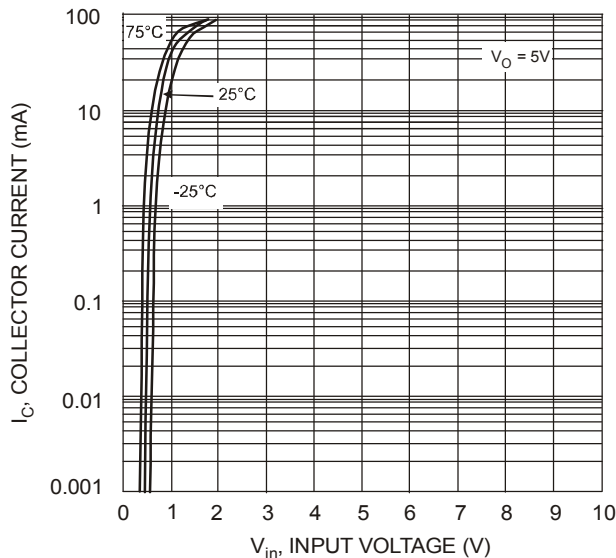

Fig. 5 Collector Current vs. Input Voltage

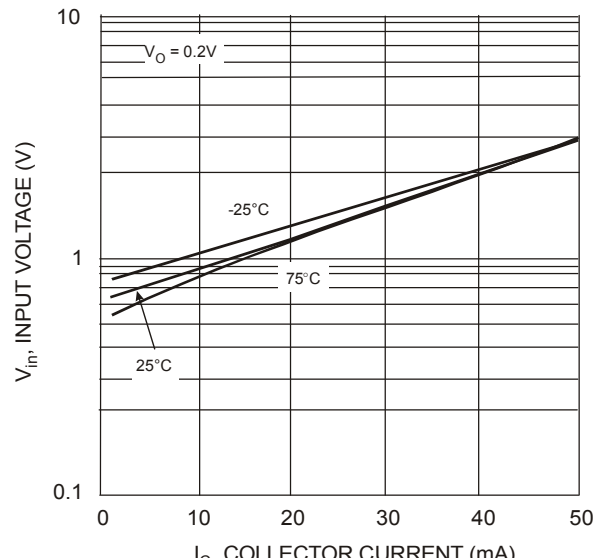

Fig. 6 Input Voltage vs. Collector Current

Ordering Information (Note 5)

| Device | Packaging | Shipping |
|---------------|-----------|------------------|
| DDTC113ZE-7-F | SOT-523 | 3000/Tape & Reel |
| DDTC123YE-7-F | SOT-523 | 3000/Tape & Reel |
| DDTC123JE-7-F | SOT-523 | 3000/Tape & Reel |
| DDTC143XE-7-F | SOT-523 | 3000/Tape & Reel |
| DDTC143FE-7-F | SOT-523 | 3000/Tape & Reel |
| DDTC143ZE-7-F | SOT-523 | 3000/Tape & Reel |
| DDTC114YE-7-F | SOT-523 | 3000/Tape & Reel |
| DDTC114WE-7-F | SOT-523 | 3000/Tape & Reel |
| DDTC124XE-7-F | SOT-523 | 3000/Tape & Reel |
| DDTC144VE-7-F | SOT-523 | 3000/Tape & Reel |
| DDTC144WE-7-F | SOT-523 | 3000/Tape & Reel |

Notes: 5. For packaging details, go to our website at <http://www.diodes.com/datasheets/ap02007.pdf>.

Marking Information

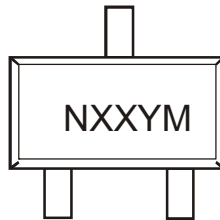

Nxx = Product Type Marking Code (See Page 1, e.g. N02 = DDTC113ZE)

YM = Date Code Marking

Y = Year ex: T = 2006

M = Month ex: 9 = September

Date Code Key

| Year | 2002 | 2003 | 2004 | 2005 | 2006 | 2007 | 2008 | 2009 | 2010 | 2011 | 2012 |
|------|------|------|------|------|------|------|------|------|------|------|------|
| Code | N | P | R | S | T | U | V | W | X | Y | Z |

| Month | Jan | Feb | Mar | Apr | May | Jun | Jul | Aug | Sep | Oct | Nov | Dec |
|-------|-----|-----|-----|-----|-----|-----|-----|-----|-----|-----|-----|-----|
| Code | 1 | 2 | 3 | 4 | 5 | 6 | 7 | 8 | 9 | O | N | D |

IMPORTANT NOTICE

Diodes Incorporated and its subsidiaries reserve the right to make modifications, enhancements, improvements, corrections or other changes without further notice to any product herein. Diodes Incorporated does not assume any liability arising out of the application or use of any product described herein; neither does it convey any license under its patent rights, nor the rights of others. The user of products in such applications shall assume all risks of such use and will agree to hold Diodes Incorporated and all the companies whose products are represented on our website, harmless against all damages.

LIFE SUPPORT

Diodes Incorporated products are not authorized for use as critical components in life support devices or systems without the expressed written approval of the President of Diodes Incorporated.

Looking for pricing, stock, or lifecycle information?

Click below to explore more details on WIN SOURCE:

-  [View DDTTC114YE-7 on WIN SOURCE](#)
-  [Diodes Incorporated Information](#)

Optimize Your Supply Chain with WIN SOURCE Solutions

-  Global Sourcing Solution
-  Obsolete Management
-  Cost Control Management
-  Shortage Management
-  Alternative Solution
-  Excess Inventory Management