



**THE DATASHEET OF
TLE4942-1C**



Differential Two-Wire Hall Effect
Sensor-IC for Wheel Speed Applications
with Direction Detection

TLE4942-1C in PG-SSO2-4

Sensors



Never stop thinking.

Edition 2010-02-25

**Published by
Infineon Technologies AG
81726 München, Germany**

**© 2010 Infineon Technologies AG
All Rights Reserved.**

Legal Disclaimer

The information given in this document shall in no event be regarded as a guarantee of conditions or characteristics. With respect to any examples or hints given herein, any typical values stated herein and/or any information regarding the application of the device, Infineon Technologies hereby disclaims any and all warranties and liabilities of any kind, including without limitation, warranties of non-infringement of intellectual property rights of any third party.

Information

For further information on technology, delivery terms and conditions and prices, please contact the nearest Infineon Technologies Office (www.infineon.com).

Warnings

Due to technical requirements, components may contain dangerous substances. For information on the types in question, please contact the nearest Infineon Technologies Office.

Infineon Technologies components may be used in life-support devices or systems only with the express written approval of Infineon Technologies, if a failure of such components can reasonably be expected to cause the failure of that life-support device or system or to affect the safety or effectiveness of that device or system. Life support devices or systems are intended to be implanted in the human body or to support and/or maintain and sustain and/or protect human life. If they fail, it is reasonable to assume that the health of the user or other persons may be endangered.

Differential Two-Wire Hall Effect Sensor IC in PG-SSO2-4

TLE4942-1C

Features

- Two-wire PWM current interface
- Detection of rotation direction
- Airgap diagnosis
- Assembly position diagnosis
- Dynamic self-calibration principle
- Single chip solution
- No external components needed
- High sensitivity
- South and north pole pre-induction possible
- High resistance to piezo effects
- Large operating air-gaps
- Wide operating temperature range
- TLE4942-1C: 1.8 nF overmolded capacitor

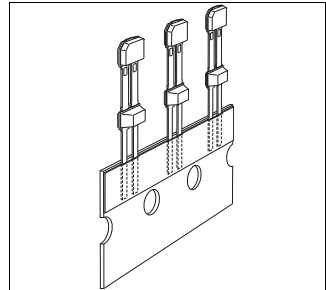

Type	Marking	Ordering Code	Package
TLE4942-1C	42C1R4	SP001952940	PG-SSO-2-4

The Hall Effect sensor IC TLE4942-1C is designed to provide information about rotational speed, direction of rotation, assembly position and limit airgap to modern vehicle dynamics control systems and ABS. The output has been designed as a two wire current interface based on a Pulse Width Modulation principle. The sensor operates without external components and combines a fast power-up time with a low cut-off frequency. Excellent accuracy and sensitivity is specified for harsh automotive requirements as a wide temperature range, high ESD robustness and high EMC resilience. State-of-the-art BiCMOS technology is used for monolithic integration of the active sensor areas and the signal conditioning.

Finally, the optimized piezo compensation and the integrated dynamic offset compensation enable easy manufacturing and elimination of magnet offsets. The TLE4942-1C is additionally provided with an overmolded 1.8 nF capacitor for improved EMI performance.

Pin Configuration
(top view)

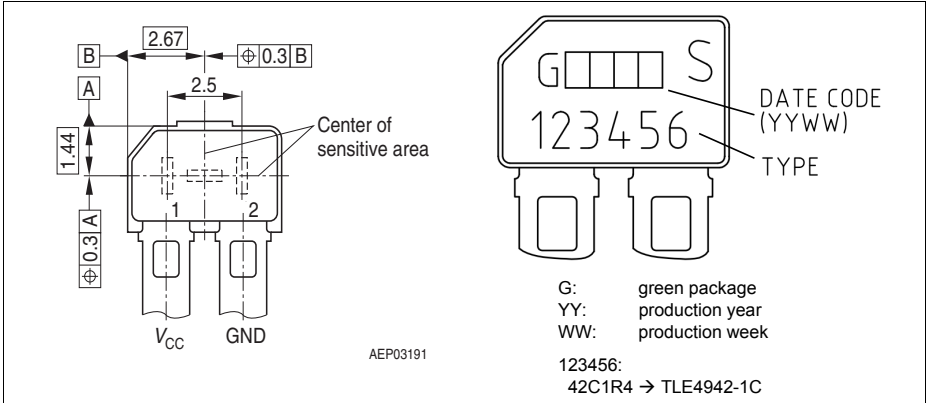

Figure 1

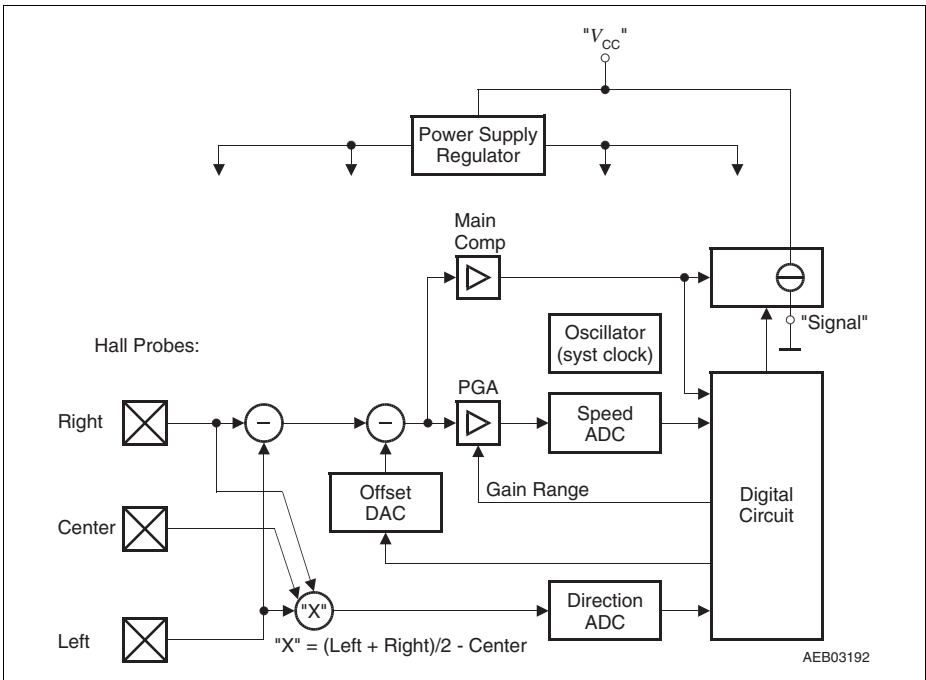

Figure 2 Block Diagram

Functional Description

The differential Hall Effect IC detects the motion of ferromagnetic or permanent magnet structures by measuring the differential flux density of the magnetic field. To detect the motion of ferromagnetic objects the magnetic field must be provided by a backbiasing permanent magnet. Either the South or North pole of the magnet can be attached to the rear, unmarked side of the IC package.

Magnetic offsets of up to ± 20 mT and mechanical offsets are cancelled out through a self-calibration algorithm. Only a few transitions are necessary for the self-calibration procedure. After the initial self-calibration sequence switching occurs when the input signal crosses the arithmetic mean of its max. and min. values (e.g. zero-crossing for sinusoidal signals).

The ON and OFF state of the IC are indicated by **High** and **Low** current consumption. Each zero crossing of the magnetic input signal triggers an output pulse.

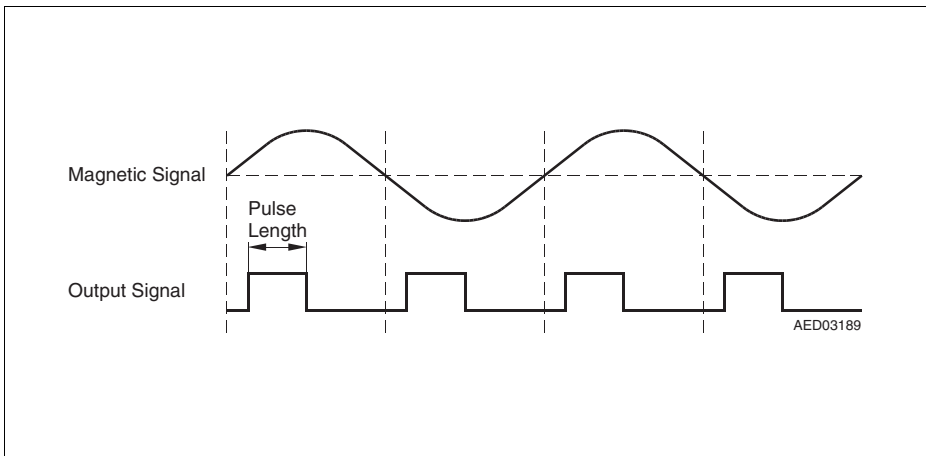

Figure 3 Zero-Crossing Principle and Corresponding Output Pulses

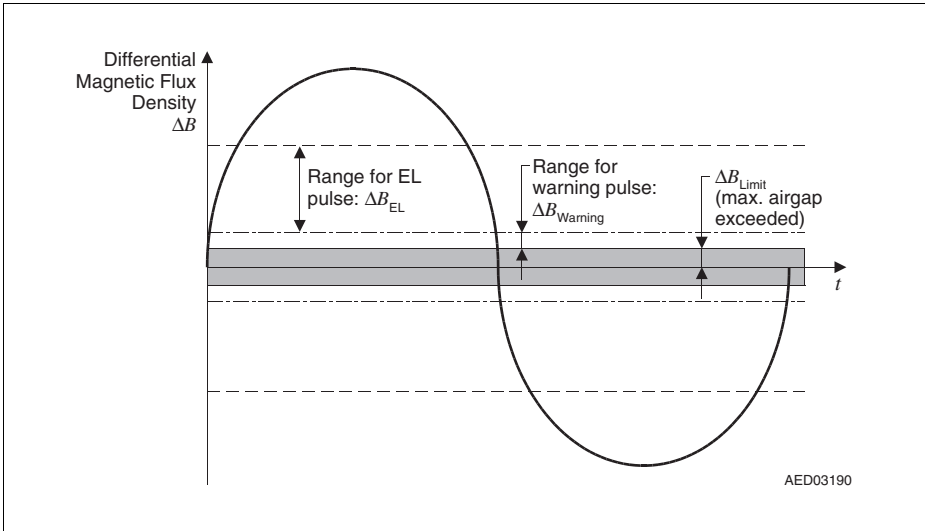

Figure 4 Definition of Differential Magnetic Flux Density Ranges

In addition to the speed signal, the following information is provided by varying the length of the output pulses in **Figure 3** (PWM modulation):

Airgap Warning range = Warning

Warning information is issued in the output pulse length when the magnetic field is below a critical value (e. g. the airgap between the Hall Effect IC and the target wheel exceeds a critical value). The device works with reduced functionality. Warning information is given only in calibrated mode.

Assembly position range = EL

EL information is issued in the output pulse length when the magnetic field is below a predefined value (the airgap between the Hall Effect IC and the target wheel exceeds a predefined value). The device works with full functionality.

Direction of rotation right = DR-R

DR-R information is issued in the output pulse length when the target wheel in front of the Hall Effect IC moves from the pin GND to the pin V_{CC} .

Direction of rotation left = DR-L

DR-L information is issued in the output pulse length when the target wheel in front of the Hall Effect IC moves from the pin V_{CC} to the pin GND. At sufficient magnetic field the direction information will be corrected already during uncalibrated mode after 2 pulses.

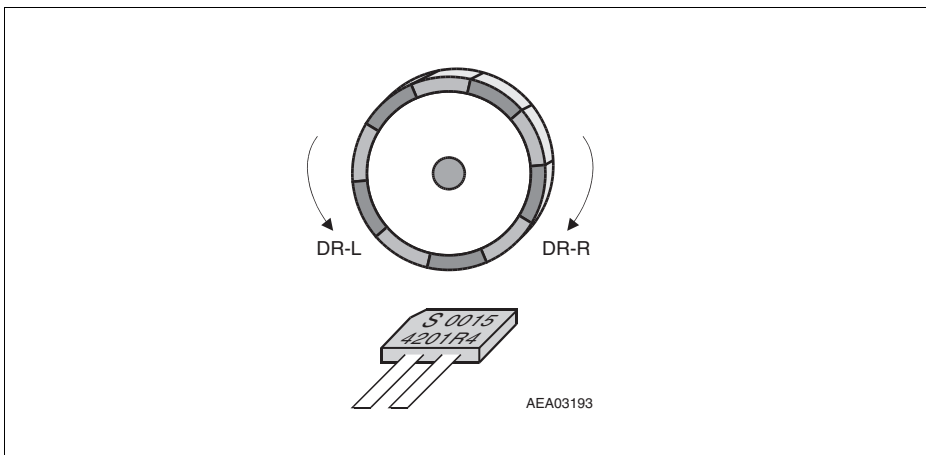

Figure 5 Definition of Rotation Direction

Circuit Description

The circuit is supplied internally by a voltage regulator. An on-chip oscillator serves as a clock generator for the DSP and the output encoder.

Speed Signal Circuitry

TLE4942-1C speed signal path comprises of a pair of Hall Effect probes, separated from each other by 2.5 mm, a differential amplifier including noise limiting low-pass filter, and a comparator triggering a switched current output stage. An offset cancellation feedback loop is provided through a signal-tracking A/D converter, a digital signal processor (DSP), and an offset cancellation D/A converter.

During the power-up phase the output is disabled (low state).

Uncalibrated Mode

Occasionally a short initial offset settling time $t_{d,input}$ might delay the detection of the input signal (the sensor is "blind"). This happens at power on or when a stop pulse is issued.

The magnetic input signal is tracked by the speed ADC and monitored within the digital circuit. For detection of a magnetic edge the signal transient needs to exceed a threshold (digital noise constant, $\Delta B_{Limit, early\ startup}$). Only the first edge is suppressed internally. With the second detected edge pulses are issued at the output. When the signal slope is identified as a rising edge (or falling edge), a comparator is triggered. The comparator is triggered again as soon as a falling edge (or rising edge respectively) is detected (and vice versa). The minimum and maximum values of the input signal are extracted and their corresponding arithmetic mean value is calculated. The offset of this mean value is determined and fed into the offset cancellation DAC.

Between the startup of the magnetic input signal and the time when its second extreme is reached, the PGA (programmable gain amplifier) will switch to its appropriate position. This value is determined by the signal amplitude and initial offset value. The digital noise constant value is increased, leading to a change in phase shift between magnetic input signal and output signal. After that consecutive output pulses should have a nominal delay of about 180°.

Transition to Calibrated Mode

In the calibrated mode the phase shift between input and output signal is no longer determined by the ratio between digital noise constant and signal amplitude. Therefore a sudden change in the phase shift may occur during the transition from uncalibrated to calibrated mode.

Calibrated Mode

During the uncalibrated mode the offset value is calculated by the peak detection algorithm. In running mode (calibrated mode) the offset correction algorithm of the DSP

is switched into a low-jitter mode, thereby avoiding oscillation of the offset DAC LSB. Switching occurs at zero-crossover of the differential magnetic signal. It is only affected by the small residual offset of the comparator and by the propagation delay time of the signal path, which is mainly determined by the noise limiting filter. Signals which are below a predefined threshold ΔB_{Limit} are not detected. This prevents unwanted switching.

The comparator also detects whether the signal amplitude exceeds $\Delta B_{\text{Warning}}$ or ΔB_{EL} . This information is fed into the DSP and the output encoder. The pulse length of the High output current is generated according to the rotational speed, the direction of rotation and the magnetic field strength.

Direction Signal Circuitry

The differential signal between a third Hall probe and the mean of the differential Hall probe pair is obtained from the direction input amplifier. This signal is digitized by the direction ADC and fed into the DSP circuitry. There, the phase of the signal referring to the speed signal is analyzed and the direction information is forwarded to the output encoder.

Additional Notes

Typically the phase error due to PGA-transition reduces the error caused by switching the mode from uncalibrated to calibrated.

In very rare cases a further PGA switching can occur during the calibration process. It can take place when the signal is extremely close to a PGA switching threshold. This additional switching might delay the transition to calibrated mode by two more pulses. The probability of this case is mainly depending on variations of magnetic amplitude under real automotive conditions (see Appendix B)

The direction detection feature is also active in the uncalibrated mode but only at substantial magnetic signal. The correct direction information is worst case available after the first two output pulses in calibrated mode. Regarding the rare case mentioned before combined with other initial conditions this may lead to a worst case of 9 pulses before correct direction information is guaranteed.

Package Information

Pure tin covering (green lead plating) is used. Leadframe material is Wieland K62 (UNS: C18090) and contains CuSn1CrNiTi. Product is ROHS compliant and may contain a data matrix code on the rear side of the package.

Table 1 Absolute Maximum Ratings

$$T_j = -40^\circ\text{C to } 150^\circ\text{C}, 4.5\text{ V} \leq V_{\text{CC}} \leq 16.5\text{ V}$$

Parameter	Symbol	Limit Values		Unit	Remarks
		min.	max.		
Supply voltage	V_{CC}	-0.3	-	V	$T_j < 80^\circ\text{C}$
		-	16.5		$T_j = 170^\circ\text{C}$
		-	20		$T_j = 150^\circ\text{C}$
		-	22		$t = 10 \times 5\text{ min}$
		-	24		$t = 10 \times 5\text{ min}$, $R_M \geq 75\ \Omega$ included in V_{CC}
		-	27		$t = 400\text{ ms}$, $R_M \geq 75\ \Omega$ included in V_{CC}
Reverse polarity current	I_{rev}	-	200	mA	External current limitation required, $t < 4\text{ h}$
Junction temperature	T_j	-	150	$^\circ\text{C}$	5000 h, $V_{\text{CC}} < 16.5\text{ V}$
		-	160		2500 h, $V_{\text{CC}} < 16.5\text{ V}$ (not additive)
		-	170		500 h, $V_{\text{CC}} < 16.5\text{ V}$ (not additive)
		-	190		4 h, $V_{\text{CC}} < 16.5\text{ V}$
Active lifetime	$t_{\text{B,active}}$	10000	-	h	
Storage temperature	T_S	-40	150	$^\circ\text{C}$	
Thermal resistance PG-SSO-2-4	R_{thJA}	-	190	K/W	1)

1) Can be improved significantly by further processing like overmolding

Note: Stresses in excess of those listed here may cause permanent damage to the device. Exposure to absolute maximum rating conditions for extended periods may affect device reliability.

Table 2 ESD Protection

Human Body Model (HBM) tests according to:
Standard EIA/JESD22-A114-B HBM (covers MIL STD 883D)

Parameter	Symbol	Limit Values		Unit	Notes
		min.	max.		
ESD-Protection TLE4942-1C	V_{ESD}	–	± 12	kV	$R = 1.5 \text{ k}\Omega$, $C = 100 \text{ pF}$

Table 3 Operating Range

Parameter	Symbol	Limit Values		Unit	Remarks
		min.	max.		
Supply voltage	V_{CC}	4.5	20	V	Directly on IC leads includes not the R_M voltage drop
Supply voltage ripple	V_{AC}	–	6	Vpp	$V_{CC} = 13 \text{ V}$ $0 < f < 50 \text{ kHz}$
Junction temperature	T_j	– 40	150	°C	500 h $V_{CC} \leq 16.5 \text{ V}$, increased jitter permissible
		–	170		
Pre-induction	B_0	– 500	+ 500	mT	
Pre-induction offset between outer probes	$\Delta B_{stat.,l/r}$	– 20	+ 20	mT	
Pre-induction offset between mean of outer probes and center probe	$\Delta B_{stat.,m/o}$	– 20	+ 20	mT	
Differential Induction	ΔB	– 120	+ 120	mT	

Note: Within the operating range the functions given in the circuit description are fulfilled.

Table 4 Electrical Characteristics

All values specified at constant amplitude and offset of input signal, over operating range, unless otherwise specified.

Typical values correspond to $V_{CC} = 12\text{ V}$ and $T_A = 25^\circ\text{C}$

Parameter	Symbol	Limit Values			Unit	Remarks
		min.	typ.	max.		
Supply current	I_{LOW}	5.9	7	8.4	mA	
Supply current	I_{HIGH}	11.8	14	16.8	mA	
Supply current ratio	I_{HIGH} / I_{LOW}	1.9	–	–		
Output rise/fall slew rate TLE4942-1C	t_r, t_f	8 8	– –	22 26	mA/ μs	$R_M = 75\ \Omega$ $T < 125^\circ\text{C}$ $T < 170^\circ\text{C}$ See Figure 6
Current ripple dI_X/dV_{CC}	I_X	–	–	90	$\mu\text{A/V}$	¹⁾⁸⁾
Limit threshold 1 Hz < f < 2500 Hz 2500 Hz < f < 5000 Hz	ΔB_{Limit}	0.35 –	0.8 –	1.5 1.6	mT	²⁾
Airgap warning threshold 1 Hz < f < 2500 Hz 2500 Hz < f < 5000 Hz	$\Delta B_{Warning}$	0.9 –	1.6 –	2.6 2.8	mT	²⁾
Limit - Airgap warning threshold ratio	$\Delta B_{Warning} / \Delta B_{Limit}$	1.3	2	2.7		
Assembly position threshold	ΔB_{EL}	5.2	7.2	9.6	mT	²⁾ At room temp
Magnetic differential field change necessary to detect magnetic edge in uncalibrated mode	$\Delta B_{Limit, early\ startup}$	–	–	–		First detected magnetic edge is suppressed (nonvalid)
$\Delta B_{Limit, early\ startup}$		0.7	1.76	3.3	mT	
Initial calibration delay time	$t_{d,input}$	255	300	345	μs	Additional to n_{start}
Magnetic edges suppressed until output switching	$n_{DZ-start}$	–	–	1 ³⁾	magn. edges	After power on and stop pulse
Magnetic edges required for offset calibration ³⁾	$n_{DZ-calibration}$	–	–	6 ³⁾	magn. edges	7 th edge correct ⁴⁾

Table 4 Electrical Characteristics (cont'd)

All values specified at constant amplitude and offset of input signal, over operating range, unless otherwise specified.

Typical values correspond to $V_{CC} = 12\text{ V}$ and $T_A = 25^\circ\text{C}$

Parameter	Symbol	Limit Values			Unit	Remarks
		min.	typ.	max.		
in rare cases (see Appendix B)	$n_{DZ\text{-calibration-rare}}$	—	—	8	edges	
Number of pulses in uncalibrated mode	$n_{DZ\text{-Startup}}$	—	—	5	pulses	
in rare cases (see Appendix B)	$n_{DZ\text{-Startup-rare}}$	—	—	7	pulses	
Number of pulses with invalid direction information $\Delta B < \Delta B_{EL}$ $\Delta B > \Delta B_{EL}$	$n_{DR\text{-Startup}}$	—	—	7 2 ⁵⁾	pulses	After $n_{DR\text{-Startup}}$ pulses + 1 the direction information is correct
Number of pulses with invalid assembly bit information	$n_{EL\text{-Startup}}$	—	—	7	pulses	After $n_{EL\text{-Startup}}$ pulses + 1 the assembly bit information is correct
Number of pulses where the airgap warning information is suppressed	$n_{LR\text{-Startup}}$	—	—	5	pulses	LR information is provided only in calibrated mode
Signal behavior after undervoltage or standstill $> t_{\text{Stop}}$ Number of magnetic edges where the first pulse is given.	$n_{DZ\text{-Start}}$	—	—	2	edges	Magnetic edge according to ΔB_{Limit} , early startup $t_{d,\text{input}}$ has to be taken into account
Shortest time delay between pulse 0 (stop pulse) and pulse 1		293	345	397	µs	Reference rising edges, includes pre low length
Shortest time delay between wheel speed pulse 1 and 2 and all further pulses		38	45	52	µs	Falling to rising edge - identical with pre low bit length

Table 4 Electrical Characteristics (cont'd)

All values specified at constant amplitude and offset of input signal, over operating range, unless otherwise specified.

Typical values correspond to $V_{CC} = 12\text{ V}$ and $T_A = 25^\circ\text{C}$

Parameter	Symbol	Limit Values			Unit	Remarks
		min.	typ.	max.		
Phase shift change during PGA switching		0	–	80	°	
Phase shift change during transition from uncalibrated to calibrated mode	$\Delta\Phi_{\text{switch}}$	– 90	–	+ 90	°	
Frequency	f	1 2500	– –	2500 5000	Hz	6)
Frequency changes	df/dt	–	–	± 100	Hz/ms	
Duty cycle	duty	40	50	60	%	7) Measured @ $\Delta B = 2\text{ mT}$ sine wave Def. Figure 7
Jitter, $T_j < 150^\circ\text{C}$ $T_j < 170^\circ\text{C}$ $1\text{ Hz} < f < 2500\text{ Hz}$	$S_{\text{Jit-close}}$	– –	– –	± 2 ± 3	%	8) 1σ value $V_{CC} = 12\text{ V}$ $\Delta B \geq 2\text{ mT}$
Jitter, $T_j < 150^\circ\text{C}$ $T_j < 170^\circ\text{C}$ $2500\text{ Hz} < f < 5000\text{ Hz}$	$S_{\text{Jit-close}}$	– –	– –	± 3 ± 4.5	%	8) 1σ value $V_{CC} = 12\text{ V}$ $\Delta B \geq 2\text{ mT}$
Jitter, $T_j < 150^\circ\text{C}$ $T_j < 170^\circ\text{C}$ $1\text{ Hz} < f < 2500\text{ Hz}$	$S_{\text{Jit-far}}$	– –	– –	± 4 ± 6	%	8) 1σ value $V_{CC} = 12\text{ V}$ $2\text{ mT} \geq \Delta B > \Delta B_{\text{Limit}}$
Jitter, $T_j < 150^\circ\text{C}$ $T_j < 170^\circ\text{C}$ $2500\text{ Hz} < f < 5000\text{ Hz}$	$S_{\text{Jit-far}}$	– –	– –	± 6 ± 9	%	8) 1σ value $V_{CC} = 12\text{ V}$ $2\text{ mT} \geq \Delta B > \Delta B_{\text{Limit}}$
Jitter during startup and uncalibrated mode	$S_{\text{Jit-close}}$ (1σ -value)	–	–	± 3	%	8) $-40^\circ\text{C} \leq T_{\text{amb}} \leq 150^\circ\text{C}$ $150^\circ\text{C} \leq T_{\text{amb}} \leq 170^\circ\text{C}$
		–	–	± 4		
	$S_{\text{Jit-far}}$ (1σ -value)	–	–	± 5	%	8) $-40^\circ\text{C} \leq T_{\text{amb}} \leq 150^\circ\text{C}$ $150^\circ\text{C} \leq T_{\text{amb}} \leq 170^\circ\text{C}$
		–	–	± 7		

Table 4 Electrical Characteristics (cont'd)

All values specified at constant amplitude and offset of input signal, over operating range, unless otherwise specified.

Typical values correspond to $V_{CC} = 12\text{ V}$ and $T_A = 25^\circ\text{C}$

Parameter	Symbol	Limit Values			Unit	Remarks
		min.	typ.	max.		
Jitter at board net ripple	$S_{\text{Jit-AC}}$	–	–	± 2	%	⁸⁾ $V_{CC} = 13\text{ V} \pm 6\text{ Vpp}$ $0 < f < 50\text{ kHz}$ $\Delta B = 15\text{ mT}$
Jitter at board net ripple in uncalibrated mode	$S_{\text{Jit-AC}}$ (1 σ -value)	–	–	± 3	%	⁸⁾ $V_{CC} = 13\text{ V} \pm 6\text{ Vpp}$ $0 < f < 50\text{ kHz}$ $\Delta B = 15\text{ mT}$

- 1) higher values occur due to R_m -C combination
- 2) Magnetic amplitude values, sine magnetic field, Limits refer to the 50% criteria. 50% of pulses are missing or wrong. Valid in calibrated mode only.
- 3) The sensor requires up to n_{start} magnetic switching edges for valid speed information after power-up or after a stand still condition. During that phase the output is disabled.
- 4) One magnetic edge is defined as a monotonic signal change of more than 3.3 mT
- 5) Direction signal is given already during uncalibrated mode. Assembly Bit information is only provided in calibrated mode
- 6) High frequency behavior not subject to production test - verified by design/characterization. Frequency above 2500 Hz may have influence on jitter performance and magnetic thresholds. DR-R pulse length will be cut off above app. 3.3 kHz Therefore direction detection may not be possible anymore at high frequency.
- 7) During fast offset alterations, due to the calibration algorithm, exceeding the specified duty cycle is permitted for short time periods
- 8) Not subject to production test- verified by design/characterization

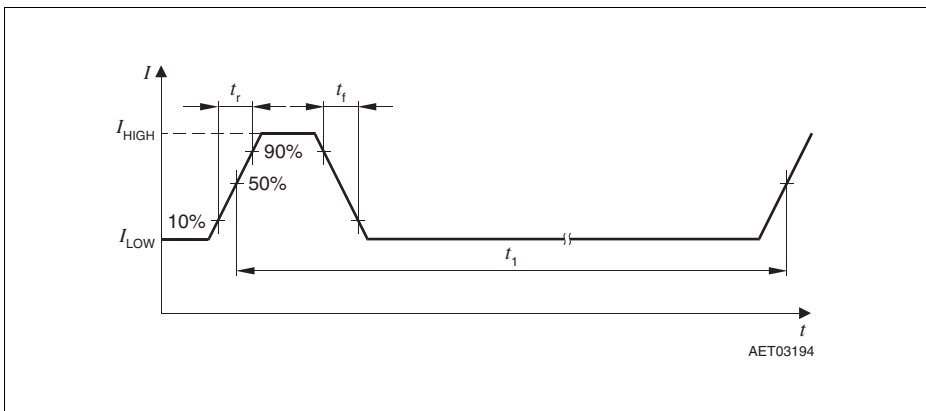

Figure 6 Definition of Rise and Fall Time

Table 5 Timing Characteristics

Parameter	Symbol	Limit Values			Unit	Remarks
		min.	typ.	max.		
Pre-low length	$t_{pre-low}$	38	45	52	μs	
Length of Warning pulse	$t_{Warning}$	38	45	52	μs	
Length of DR-L pulse	t_{DR-L}	76	90	104	μs	
Length of DR-R pulse	t_{DR-R}	153	180	207	μs	
Length of DR-L & EL pulse	$t_{DR-L\&EL}$	306	360	414	μs	
Length of DR-R & EL pulse	$t_{DR-R\&EL}$	616	720	828	μs	
Output of EL pulse, maximum frequency	f_{ELmax}	–	117	–	Hz	
Length of stand still pulse	t_{Stop}	1.232	1.44	1.656	ms	See Figure 9
Stand still period ¹⁾	T_{Stop}	590	737	848	ms	See Figure 9

1) If no magnetic switching edge is detected for a period longer than T_{stop} , the stand still pulse is issued

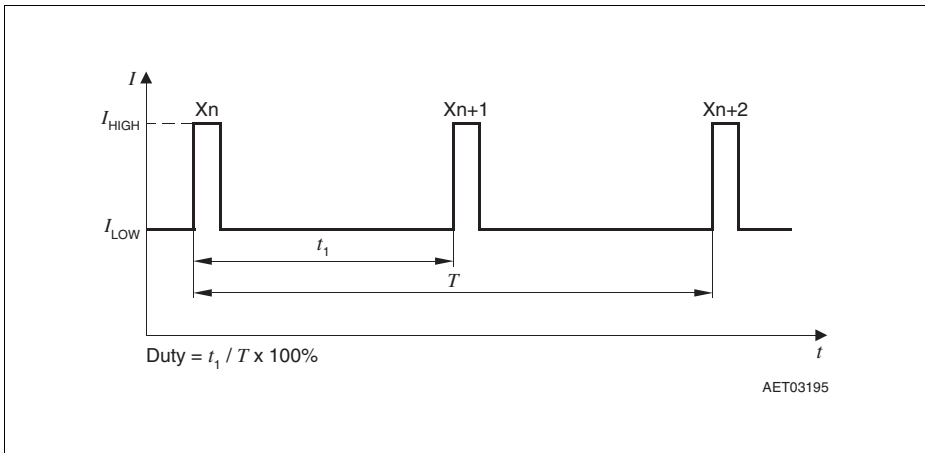

Figure 7 Definition of Duty Cycle

PWM Current Interface

Between each magnetic transition and the rising edge of the corresponding output pulse the output current is **Low** for $t_{pre-low}$ in order to allow reliable internal conveyance. Following the signal pulse (current is **High**) is output.

If the magnetic differential field exceeds ΔB_{EL} , the output pulse lengths are 90 μs or 180 μs respectively, depending on the direction of rotation.

When the magnitude of the magnetic differential field is below ΔB_{EL} , the output pulse lengths are 360 μs and 720 μs respectively, depending on left or right rotation. Due to decreasing cycle times at higher frequencies, these longer pulses are only output up to frequencies of approximately 117 Hz. For higher frequencies and differential magnetic fields below ΔB_{EL} , the output pulse lengths are 90 μs or 180 μs respectively.

If the magnitude of the magnetic differential field is below $\Delta B_{Warning}$, the output pulse length is 45 μs . The warning output is dominant, this means that close to the limit airgap the direction and the assembly position information are disabled.

For magnitudes of the magnetic differential field below ΔB_{Limit} , signal is lost.

In case no magnetic differential signal is detected for a time longer than the stand still period T_{Stop} , the stop pulse is output. Typically with the first output stop pulse, the circuitry reverts to the uncalibrated mode.

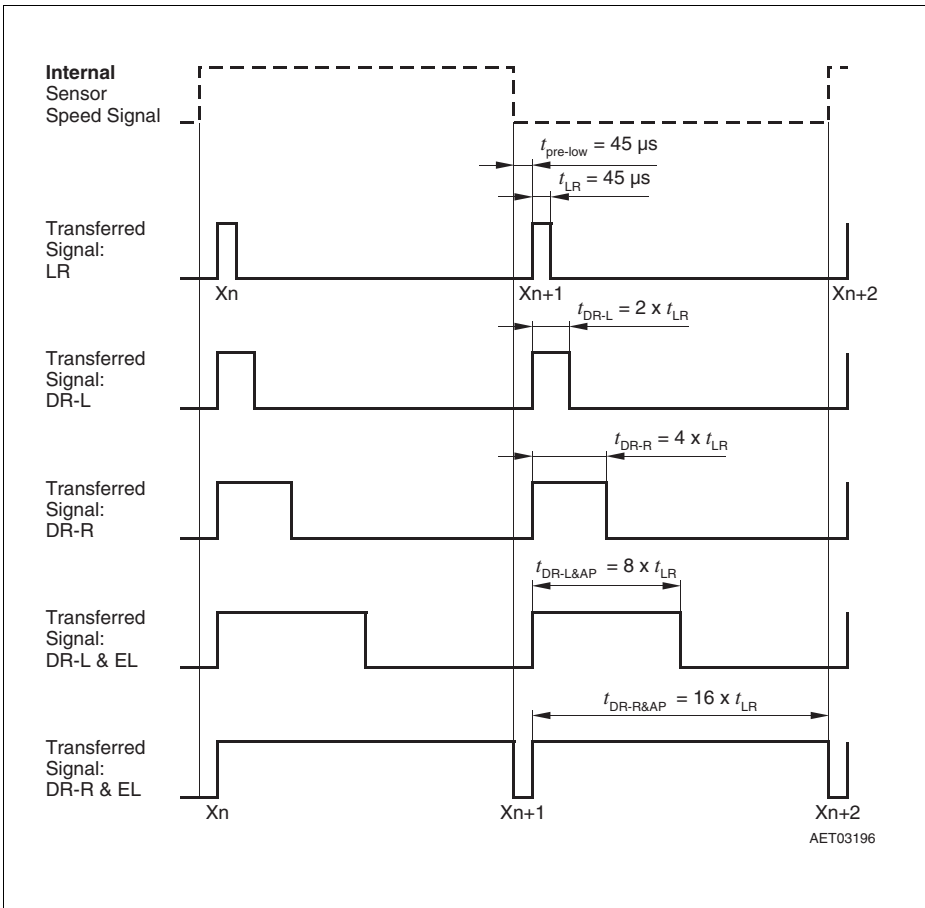

Figure 8 Definition of PWM Current Interface

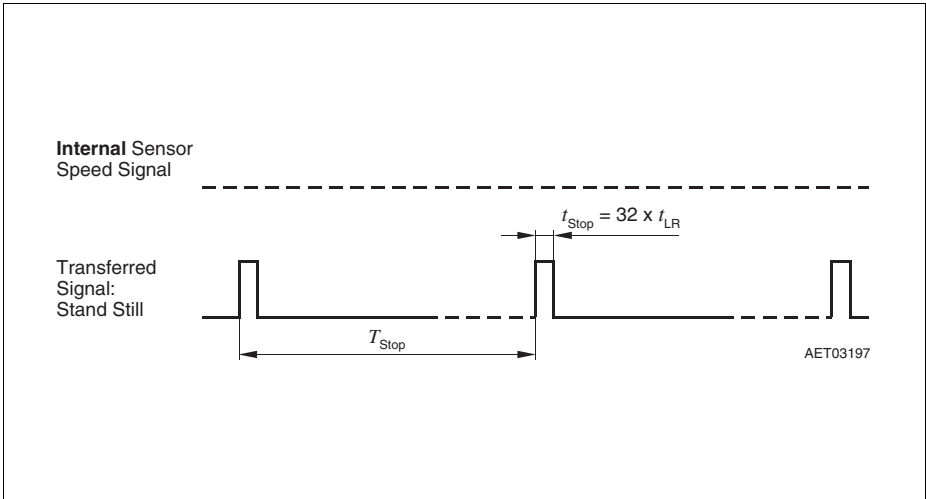

Figure 9 Definition of Stand Still Output Pulse

Duty Cycle at Fast Changing Frequencies

If the duty cycle deviates from 50%, it is possible that the present pulse length is output entirely once and cut once, within the same period, see **Figure 10**.

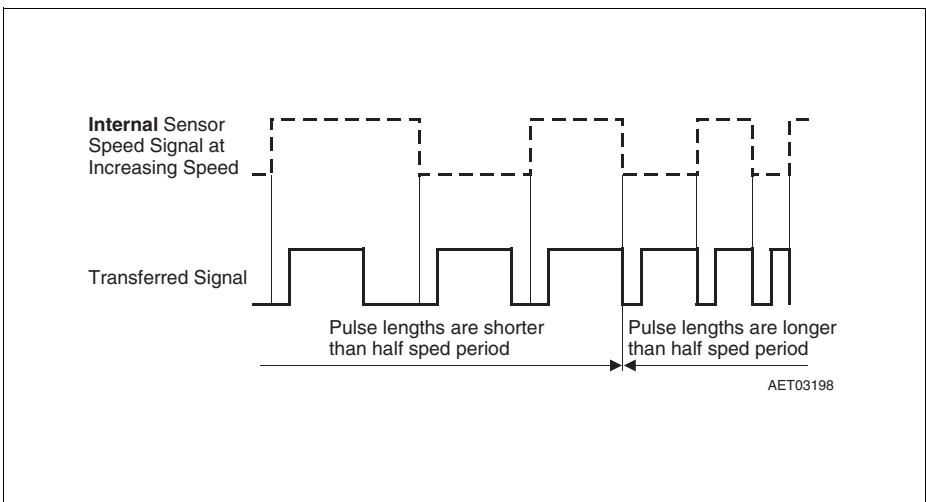

Figure 10 Deviation of Duty Cycle at Fast Changing Frequencies

Table 6 Electro Magnetic Compatibility (values depend on R_M !)

Ref. ISO 7637-1; test circuit 1;

 $\Delta B = 2 \text{ mT}$ (amplitude of sinus signal); $V_{CC} = 13.5 \text{ V}$, $f_B = 100 \text{ Hz}$; $T = 25^\circ\text{C}$; $R_M \geq 75 \Omega$

Parameter	Symbol	Level/Typ	Status
Testpulse 1	V_{EMC}	IV / – 100 V	C ¹⁾
Testpulse 2		IV / 100 V	C ¹⁾
Testpulse 3a		IV / – 150 V	A
Testpulse 3b		IV / 100 V	A
Testpulse 4		IV / – 7 V	B ²⁾
Testpulse 5		IV / 86.5 ³⁾ V	C

 1) According to 7637-1 the supply switched "OFF" for $t = 200 \text{ ms}$

 2) According to 7637-1 for test pulse 4 the test voltage shall be $12 \text{ V} \pm 0.2 \text{ V}$. Measured with $R_M = 75 \Omega$ only.

Mainly the current consumption will decrease. Status C with test circuit 1.

3) Applying in the board net a suppressor diode with sufficient energy absorption capability

Note: Values are valid for all TLE4941C/42C types!

Ref. ISO 7637-3; test circuit 1;

 $\Delta B = 2 \text{ mT}$ (amplitude of sinus signal); $V_{CC} = 13.5 \text{ V}$, $f_B = 100 \text{ Hz}$; $T = 25^\circ\text{C}$; $R_M \geq 75 \Omega$

Parameter	Symbol	Level/Typ	Status
Testpulse 1	V_{EMC}	IV / – 30 V	A
Testpulse 2		IV / 30 V	A
Testpulse 3a		IV / – 60 V	A
Testpulse 3b		IV / 40 V	A

Note: Values are valid for all TLE4941C/42C types!

Ref. ISO 11452-3; test circuit 1; measured in TEM-cell

 $\Delta B = 2 \text{ mT}$; $V_{CC} = 13.5 \text{ V}$, $f_B = 100 \text{ Hz}$; $T = 25^\circ\text{C}$

Parameter	Symbol	Level/Typ	Remarks
EMC field strength	$E_{TEM\text{-}Cell}$	IV / 250 V/m	AM = 80%, $f = 1 \text{ kHz}$

Note: Only valid for C-types!

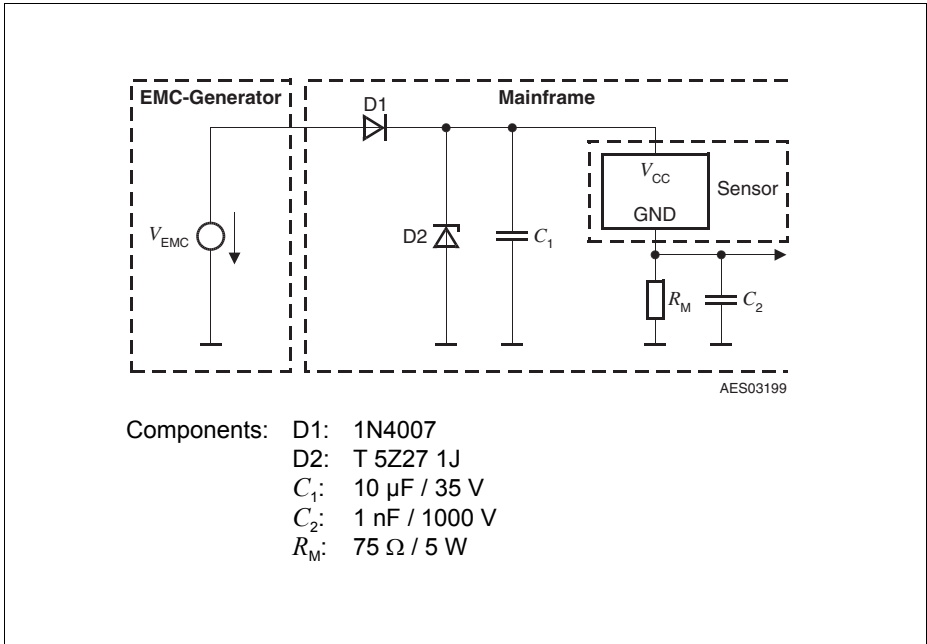

Figure 11 Test Circuit 1

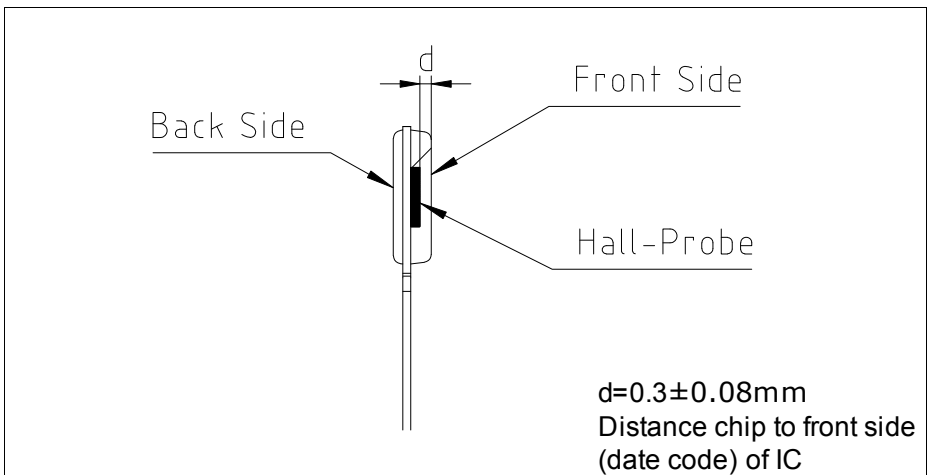

Figure 12 Distance Chip to Upper Side of IC

Appendix A

Typical Diagrams (measured performance)

$T_C = T_{\text{case, IC}} = \text{approx. } T_j - 5^\circ\text{C}$

Supply Current

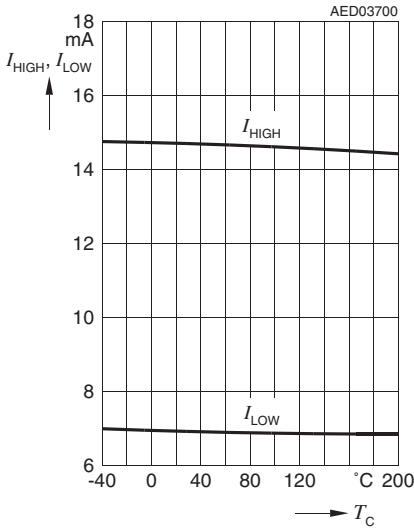

Supply Current Ratio $I_{\text{HIGH}} / I_{\text{LOW}}$

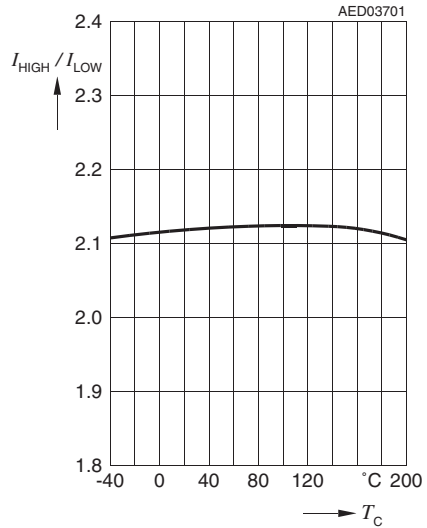

Supply Current = $f(V_{\text{CC}})$

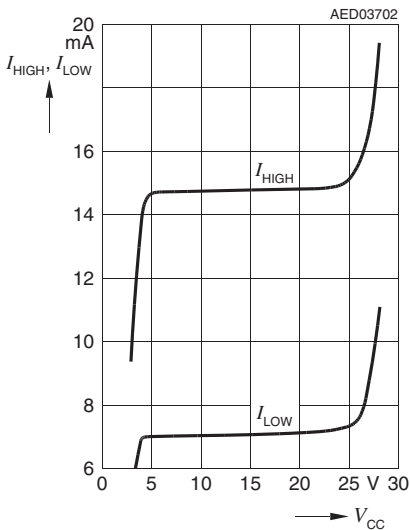

Supply Current Ratio $I_{\text{HIGH}} / I_{\text{LOW}} = f(V_{\text{CC}})$

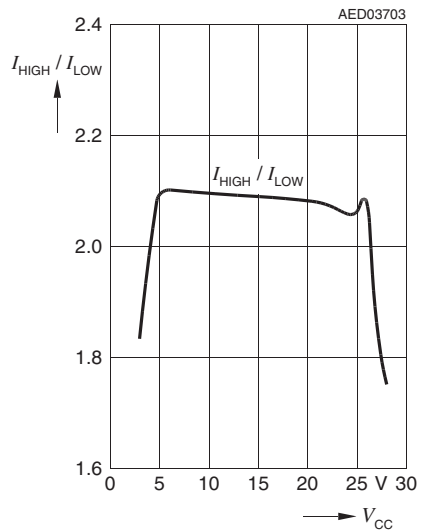

Slew Rate with $C = 1.8 \text{ nF} = f(R_M)$

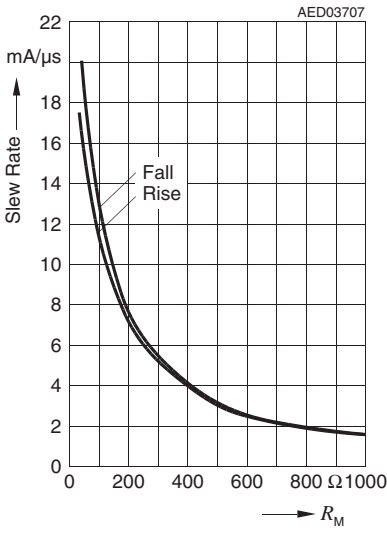

Slew Rate with $C = 1.8 \text{ nF}, R_M = 75 \Omega$

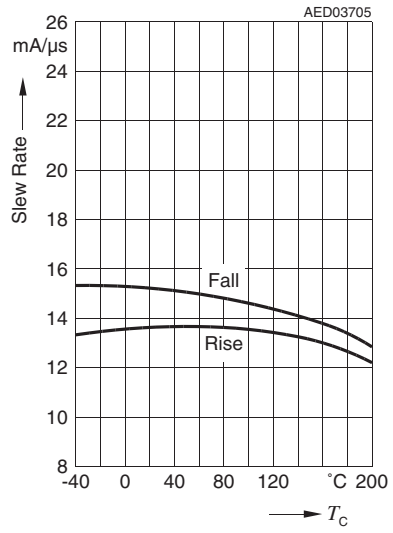

Magnetic Threshold

$\Delta B_{\text{warning}}, \Delta B_{\text{Limit}}$ at $f = 1 \text{ kHz}$

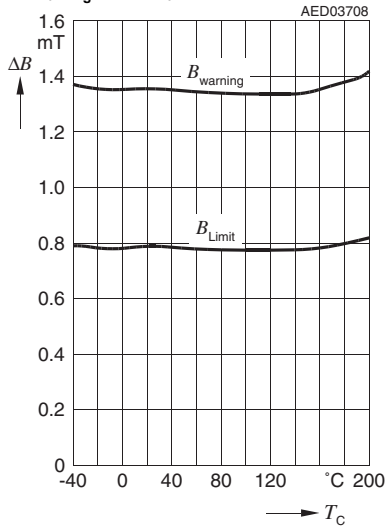

Magnetic Threshold

$\Delta B_{\text{EL}} 01$

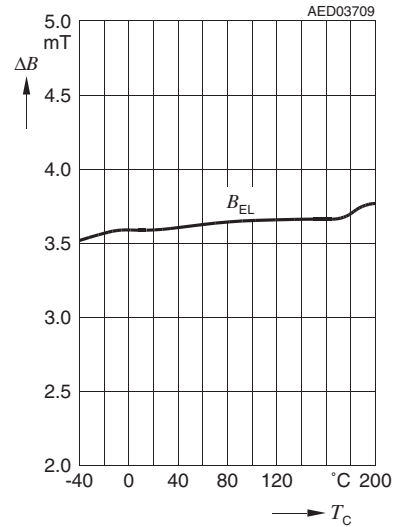

Magnetic Threshold

$\Delta B_{\text{warning}} = f(f), \Delta B_{\text{Limit}} = f(f)$

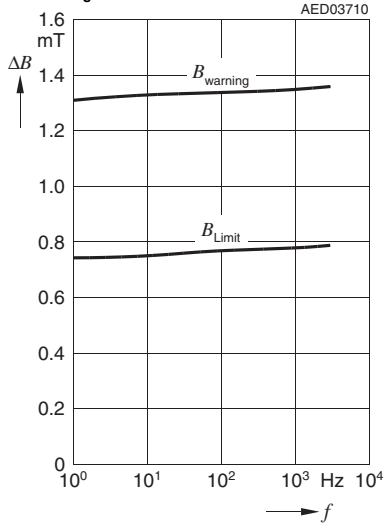

Magnetic Threshold

$\Delta B_{\text{EL}} 04$

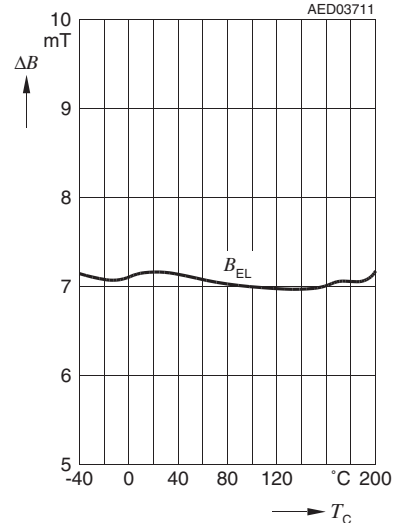

Jitter 1 at $B = 2\text{ mT}$, 1 kHz

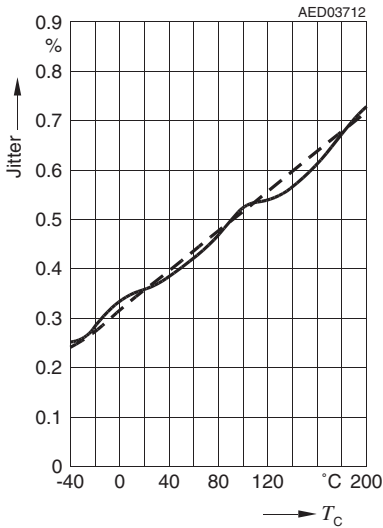

Pulse Length of Direction Signal Left and Right (t_{DR-L} , t_{DR-R})²⁾

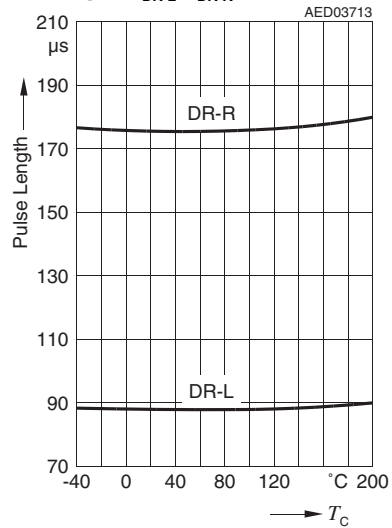

Delaytime t_d ¹⁾

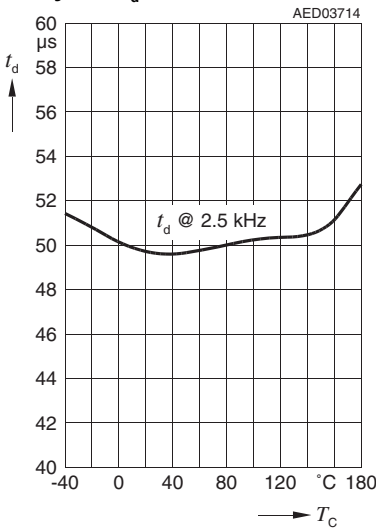

2) Temp. Behaviour of Other Pulse Lengths are similar

1) t_d is the time between the zero crossing of $\Delta B = 2\text{ mT}$ sinusoidal input signal and the rising edge (50%) of the signal current.

Appendix B

Release 2.0

Occurrence of initial calibration delay time $t_{d, \text{input}}$

If there is no input signal (standstill), a new initial calibration is triggered each 0.7 s. This calibration has a duration $t_{d, \text{input}}$ of max. 300 μs . No input signal change is detected during that initial calibration time.

In normal operation (signal startup) the probability of $t_{d, \text{input}}$ to come into effect is:

$t_{d, \text{input}} / \text{time frame for new calibration} = 300 \mu\text{s} / 700 \text{ms} = 0.05\%$.

After IC resets (e.g. after a significant undervoltage) $t_{d, \text{input}}$ will always come into effect.

Magnetic input signal extremely close to a PGA switching threshold during signal startup

After signal startup normally all PGA switching into the appropriate gain state happens within less than one signal period. This is included in the calculation for $n_{\text{DZ-Startup}}$. For the very rare case that the signal amplitude is extremely close to a PGA switching threshold and the full range of the following speed ADC respectively, a slight change of the signal amplitude can cause one further PGA switching. It can be caused by non-perfect magnetic signal (amplitude modulation due to tolerances of polewheel, tooth wheel or air gap variation). This additional PGA switching can result in a further delay of the calibrated output signal up to two magnetic edges leading to a worst case edges of

$n_{\text{DZ-Start up rare}} = 8$.

For a more detailed explanation please refer to the document "TLE4941/42 Application Notes - Frequently Asked Questions".

Fast change of direction signal at small fields:

The described behaviour can happen when rotation direction is changed in $t < 0.7$ s

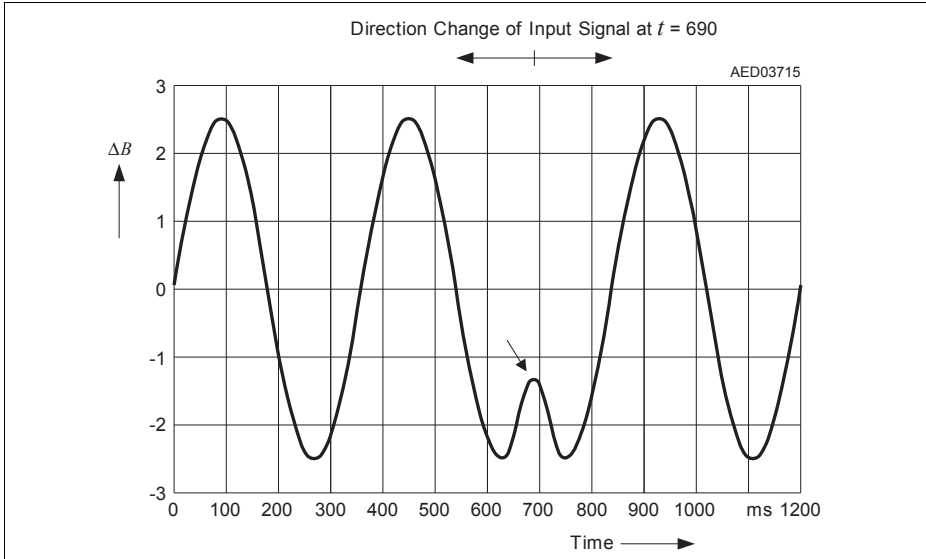

Figure 14

A local extremum (maximum or minimum) of the magnetic input signal can be caused during a reversal of rotation direction. In this case the local extremum can be detected by the IC and used for offset calibration. (E.g. the local maximum marked by an arrow in the above diagram.) Obviously the calculated offset value will be incorrect with respect to the following signal. As worst case a duty cycle up to max. 15% to 85% could occur for a few pulses. B_{warning} and B_{EL} information can be incorrect during that short period. After a re-calibration, which typically takes place after 2...3 zero-crossings the offset will be correct again and hence the duty cycle, B_{warning} and B_{EL} also.

As a result of "bad" duty cycle after fast direction reversal the sampling points for direction detection are at unusual signal phase angles also. At small magnetic input signals ($\Delta B < 1.7 \times \Delta B_{\text{warning}}$) this can lead to incorrect direction information. Duration: max. 7 pulses, in very rare cases (additional PGA transition during calibration similar to 2.) max. 9 pulses.

A local extremum close to the zero-crossing theoretically could lead to distances down to $45 \mu\text{s}$ of two consecutive output pulses at the point of direction reversal as well as a B_{warning} pulse also.

Behaviour close to the magnetic thresholds $B_{warning}$, B_{Limit} , (B_{EL})

Real non-perfect magnetic signals and intrinsic thermal noise cause amplitude variations. Very close to the magnetic thresholds a mix of output pulse widths representing the referring magnetic values occur. For similar reasons pulse widths of 90, 180, 360, 720 μ s can be observed occasionally for single pulses at B_{Limit} .

Behaviour close to speed v_5 ($f_{EL-bit} = ca. 117$ Hz)

Signal imperfections like duty cycle and jitter result in a mix of output pulses with and without assembly bit (EL) information. Input signal duty cycles apart from 50% increase the range where both pulse widths appear.

Dependency of direction detection on input signal pitch

The direction detection is optimized for a target wheel pitch of 5 mm where it will work down to $B_{warning}$. ($B_{warning}$ and direction detection thresholds meet at 5 mm pitch). For pitches other than 5 mm the magnetic input signal has to be increased to compensate for the inevitable signal attenuation.

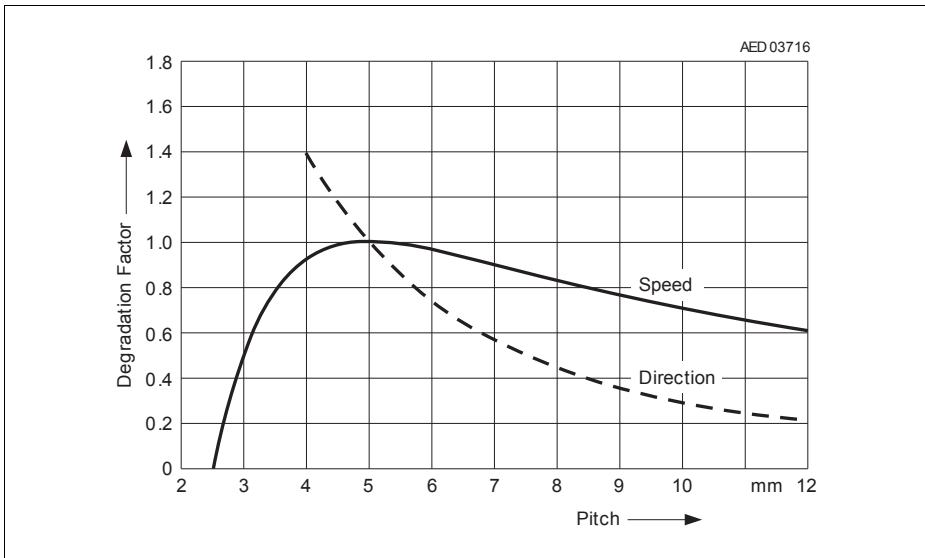

Figure 15 Degradation of speed and direction signal at sinusoidal input signals = $f_{(pitch)}$

Revision History: January 2018, V4.2

Previous Version: V3.1

Page	Subjects (major changes since last revision)
all	Updated datasheet due to PCN No 2009-069-A
all	Updated SP numbers due to PCN 2017-106

For questions on technology, delivery and prices please contact the Infineon Technologies offices in Germany or the Infineon Technologies Companies and Representatives worldwide: see our webpage at <http://www.infineon.com>

We Listen to Your Comments

Any information within this document that you feel is wrong, unclear or missing at all? Your feedback will help us to continuously improve the quality of this document. Please send your proposal (including a reference to this document) to:



sensors@infineon.com

www.infineon.com







Published by Infineon Technologies AG

Looking for pricing, stock, or lifecycle information?

Click below to explore more details on WIN SOURCE:

-  [View TLE4942-1C on WIN SOURCE](#)
-  [Infineon Technologies](#) Information

Optimize Your Supply Chain with WIN SOURCE Solutions

-  Global Sourcing Solution
-  Obsolete Management
-  Cost Control Management
-  Shortage Management
-  Alternative Solution
-  Excess Inventory Management