

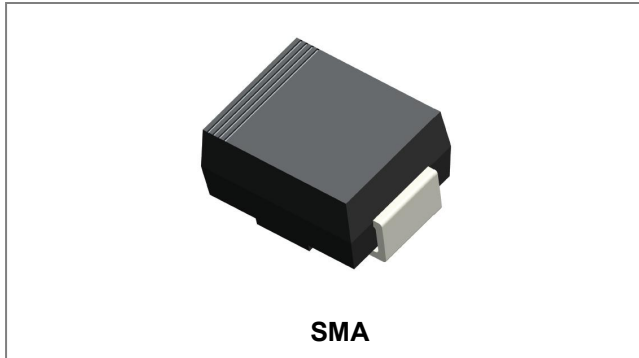

# THE DATASHEET OF ES2E



## ES2A-ES2J SURFACE MOUNT SUPER FAST RECTIFIER



### Features

- Glass Passivated Die Construction
- Ideally Suited for Automatic Assembly
- Low Forward Overload Drop, High Efficiency
- Low Power Loss
- Super-Fast Recovery Time
- Plastic Case Material has UL Flammability Classification Rating 94V-O
- This is a Pb – Free Device
- All SMC parts are traceable to the wafer lot
- Additional testing can be offered upon request

### Circuit Diagram



### Mechanical Data

- Case: Low Profile Molded Plastic
- Terminals: Solder Plated, Solderable per MIL-STD-750, Method 2026
- Polarity: Cathode Band or Cathode Notch
- Marking: Type Number
- Weight: 0.06 grams(approx)

### Maximum Ratings and Electrical Characteristics @ $T_A=25^\circ\text{C}$ unless otherwise specified

Characteristic	Symbol	ES2A	ES2B	ES2C	ES2D	ES2E	ES2G	ES2J	Units
Peak Repetitive Reverse Voltage Working Peak Reverse Voltage DC Blocking Voltage	$V_{RRM}$ $V_{RWM}$ $V_R$	50	100	150	200	300	400	600	V
RMS Reverse Voltage	$V_{R(RMS)}$	34	70	105	140	210	280	420	
Average Rectified Output Current @ $T_L = 110^\circ\text{C}$	$I_O$	2.0							A
Peak Forward Surge Current 8.3ms Single half sine-wave superimposed on rated load (JEDEC Method)	$I_{FSM}$	50							A
Forward Voltage @ $I_F = 2.0\text{A}$ , $T_J = 25^\circ\text{C}$	$V_F$	0.95			1.25		1.7		V
Maximum DC reverse current at rated DC blocking voltage $T_A = 25^\circ\text{C}$ $T_A = 100^\circ\text{C}$	$I_R$	5.0 500							$\mu\text{A}$
Typical junction capacitance (Note 1)	$C_J$	25							pF
Maximum Reverse Recovery Time (Note 2)	$T_{rr}$	35							ns
Typical thermal resistance (Note 3)	$R_{\theta JL}$	20							K/W
Operating junction and storage temperature range	$T_J, T_{STG}$	-55 to +150							$^\circ\text{C}$

**Note:** 1. Measured at 1.0 MHz and applied reverse voltage of 4.0 V<sub>DC</sub>  
 2. Measured with  $I_F=0.5\text{A}$ ,  $I_R=1.0\text{A}$ ,  $t_r=0.25\mu\text{s}$   
 3. Mounted on P.C. Board with 8.0mm<sup>2</sup> lead area

**Ratings and Characteristics Curves**

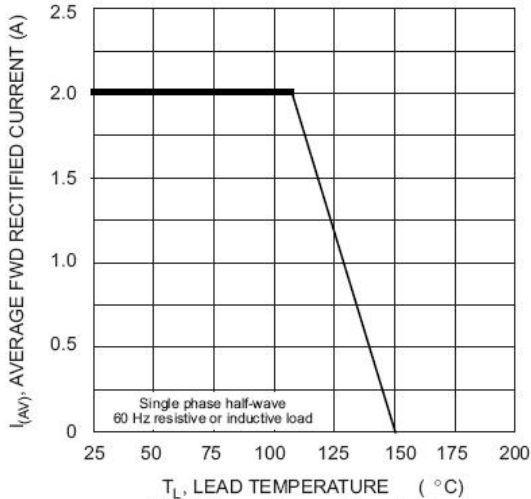

Fig. 1 Forward Current Derating Curve

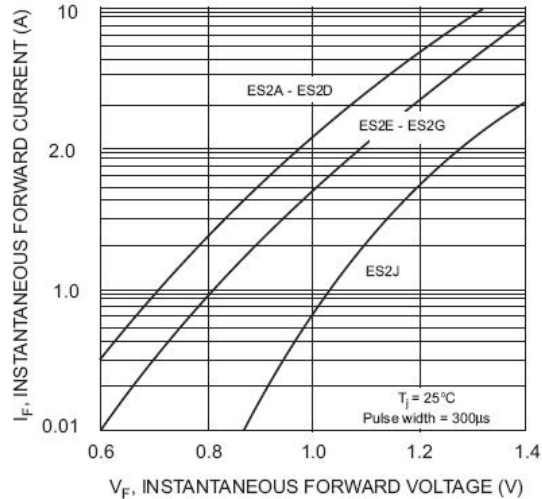

Fig. 2 Typical Forward Characteristics

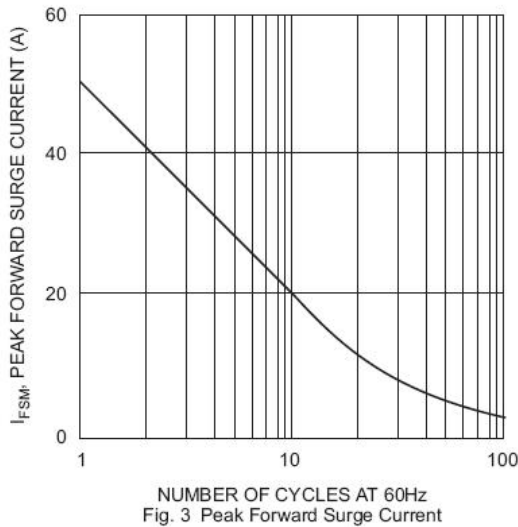

Fig. 3 Peak Forward Surge Current

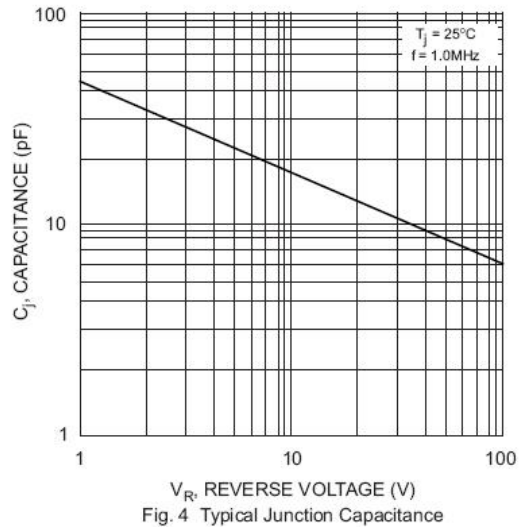
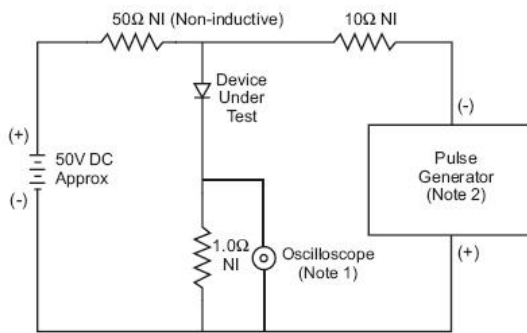

Fig. 4 Typical Junction Capacitance



Notes:  
1. Rise Time = 7.0ns max. Input Impedance = 1.0M $\Omega$ , 22pF.  
2. Rise Time = 10ns max. Input Impedance = 50 $\Omega$ .

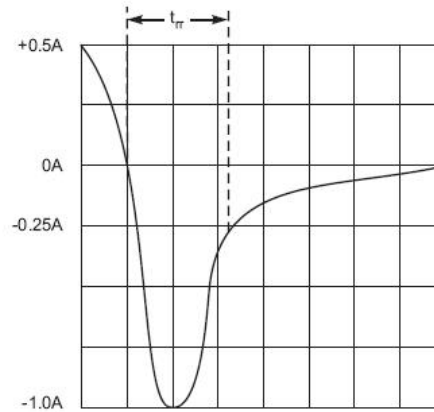
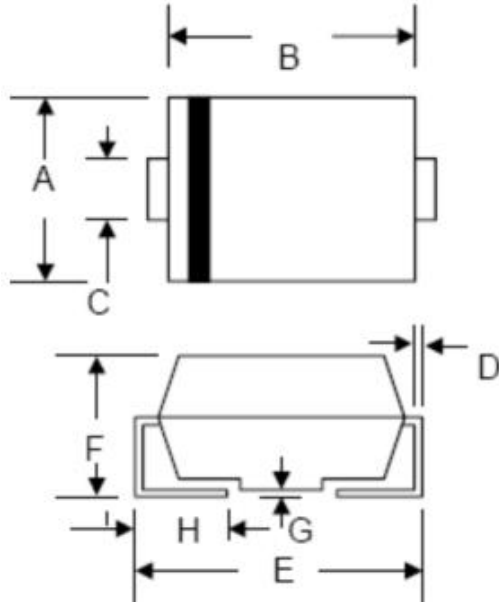

Fig. 5 Reverse Recovery Time Characteristic and Test Circuit

**Mechanical Dimensions SMA**

SYMBOL	Millimeters		Inches	
	Min.	Max.	Min.	Max.
A	2.18	2.90	0.086	0.114
B	3.99	4.60	0.157	0.181
C	1.29	1.70	0.508	0.067
D	0.152	0.305	0.006	0.012
E	4.70	5.31	0.185	0.209
F	1.70	2.50	0.067	0.098
G	0.051	0.203	0.002	0.008
H	0.76	1.55	0.030	0.610

**Ordering Information**

Device	Package	Shipping
ES2A-ES2M	SMA (Pb-Free)	5000pcs / reel

For information on tape and reel specifications, including part orientation and tape sizes, please refer to our tape and reel packaging specification.

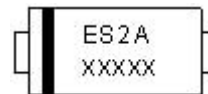
**Marking Diagram**

Where XXXXX is YYWWL

ES = Device Type  
 2 = Forward Current (2A)  
 A = Reverse Voltage (50V)  
 YY = Year  
 WW = Week  
 L = Lot Number

**Cautions:** Molding resin  
 Epoxy resin UL:94V-0

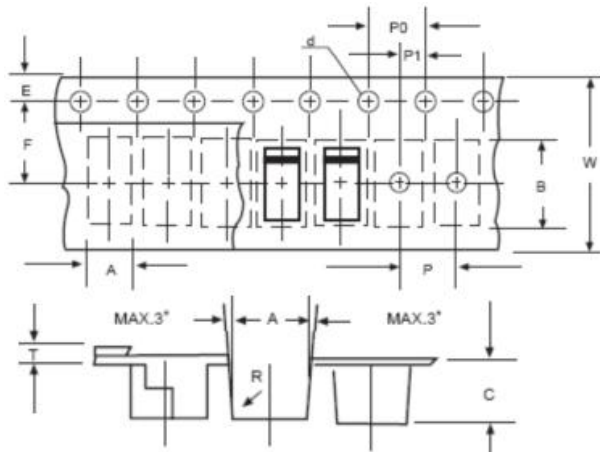
**Carrier Tape Specification SMA**

SYMBOL	Millimeters	
	Min.	Max.
A	2.97	3.17
B	5.70	5.90
C	2.32	2.52
d	1.40	1.60
E	1.40	1.60
F	5.60	5.70
P	3.90	4.10
P0	3.90	4.10
P1	1.90	2.10
T	0.25	0.35
W	11.80	12.20

**DISCLAIMER:**

1- The information given herein, including the specifications and dimensions, is subject to change without prior notice to improve product characteristics. Before ordering, purchasers are advised to contact the SMC - Sangdest Microelectronics (Nanjing) Co., Ltd sales department for the latest version of the datasheet(s).

2- In cases where extremely high reliability is required (such as use in nuclear power control, aerospace and aviation, traffic equipment, medical equipment, and safety equipment), safety should be ensured by using semiconductor devices that feature assured safety or by means of users' fail-safe precautions or other arrangement.

3- In no event shall SMC - Sangdest Microelectronics (Nanjing) Co., Ltd be liable for any damages that may result from an accident or any other cause during operation of the user's units according to the datasheet(s). SMC - Sangdest Microelectronics (Nanjing) Co., Ltd assumes no responsibility for any intellectual property claims or any other problems that may result from applications of information, products or circuits described in the datasheets.

4- In no event shall SMC - Sangdest Microelectronics (Nanjing) Co., Ltd be liable for any failure in a semiconductor device or any secondary damage resulting from use at a value exceeding the absolute maximum rating.



5- No license is granted by the datasheet(s) under any patents or other rights of any third party or SMC - Sangdest Microelectronics (Nanjing) Co., Ltd.

6- The datasheet(s) may not be reproduced or duplicated, in any form, in whole or part, without the expressed written permission of SMC - Sangdest Microelectronics (Nanjing) Co., Ltd.

7- The products (technologies) described in the datasheet(s) are not to be provided to any party whose purpose in their application will hinder maintenance of international peace and safety nor are they to be applied to that purpose by their direct purchasers or any third party. When exporting these products (technologies), the necessary procedures are to be taken in accordance with related laws and regulations..

## Looking for pricing, stock, or lifecycle information?

Click below to explore more details on WIN SOURCE:

-  [View ES2E on WIN SOURCE](#)
-  [SMC Diode Solutions](#) Information

## Optimize Your Supply Chain with WIN SOURCE Solutions

-  Global Sourcing Solution
-  Obsolete Management
-  Cost Control Management
-  Shortage Management
-  Alternative Solution
-  Excess Inventory Management