



**THE DATASHEET OF  
AP3772HBK6TR-G1**



**Low-Power Off-line Primary Side Regulation Controller****AP3772H****General Description**

The AP3772H is a high performance AC/DC power supply controller for battery charger and adapter applications. The device uses Pulse Frequency Modulation (PFM) method to build discontinuous conduction mode (DCM) flyback power supplies.

The AP3772H provides accurate constant voltage, constant current (CV/CC) regulation without requiring an opto-coupler and the secondary control circuitry. It also eliminates the need of loop compensation circuitry while maintaining good stability. The AP3772H can achieve excellent regulation and high average efficiency, yet meets no-load consumption less than 30mW. It can also achieve excellent dynamic performance while maintaining 30mW standby power with AP4340.

The AP3772H has a built-in fixed cable voltage drop compensation function. The magnitude of the cable compensation voltage is set as 3% of the rated output voltage. It also has an adjustable built-in line compensation function to achieve tight CC.

The AP3772H is available in SOT-23-6 package.

**Features**

- Primary Side Control for Tight Constant Current and Constant Voltage
- 30mW No-load Input Power
- Excellent Dynamic Performance with AP4340
- Bipolar Junction Transistor (BJT) Driving
- Proprietary Adjustable Line Compensation for CC Variation
- Constant and Built-in 6%, 3% and No Cable Voltage Drop Compensation
- Enhanced Audio Noise Suppression
- Open Circuit Protection
- Over Voltage Protection
- Short Circuit Protection
- SOT-23-6 package

**Applications**

- Adapters/Chargers for Cell/cordless Phones, PDAs, MP3 and Other Portable Devices
- LED Driver
- Standby and Auxiliary Power Supplies

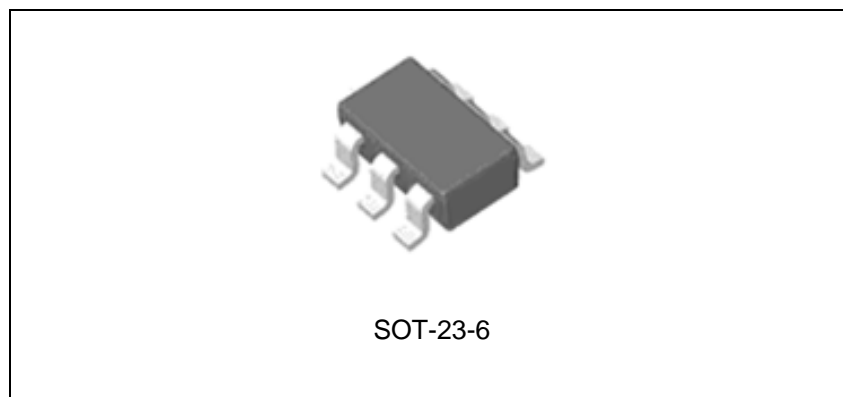

Figure 1. Package Type of AP3772H

## Pin Configuration

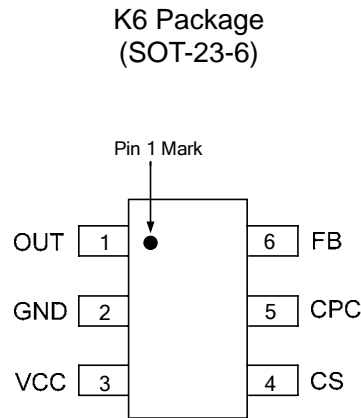

Figure 2. Pin Configuration of AP3772H (Top View)

## Pin Description

Pin Number	Pin Name	Function
1	OUT	The OUT pin is used to turn on and turn off the power switch. When turning on the power switch, the OUT pin will output 30mA source current to support the base current of the power BJT. When turning off the power switch, the resistance between the OUT and GND will become to 5Ω
2	GND	The GND pin is the ground of the IC. When the power BJT is turned off, a fast reverse sinking current to the gate of BJT will flow out from this pin. Attention should be paid to in the PCB layout
3	VCC	The VCC pin supplies the power for the IC. In order to get the correct operation of the IC, a capacitor with low ESR should be placed as close as possible to the VCC pin
4	CS	The CS is the current sense pin of the IC. The IC will turn off the power BJT according to the voltage on the CS pin. When the power BJT is on, a current is output from the CS pin which is proportional to the line voltage to realize the function of line compensation
5	CPC	A capacitor more than 10nF should be connected to this pin. The voltage of CPC pin is linear to load of the system and it is used for the functions of cable voltage drop compensation and audio noise suppression
6	FB	The CV and CC regulation are realized based on the voltage sampling of this pin

**Functional Block Diagram**

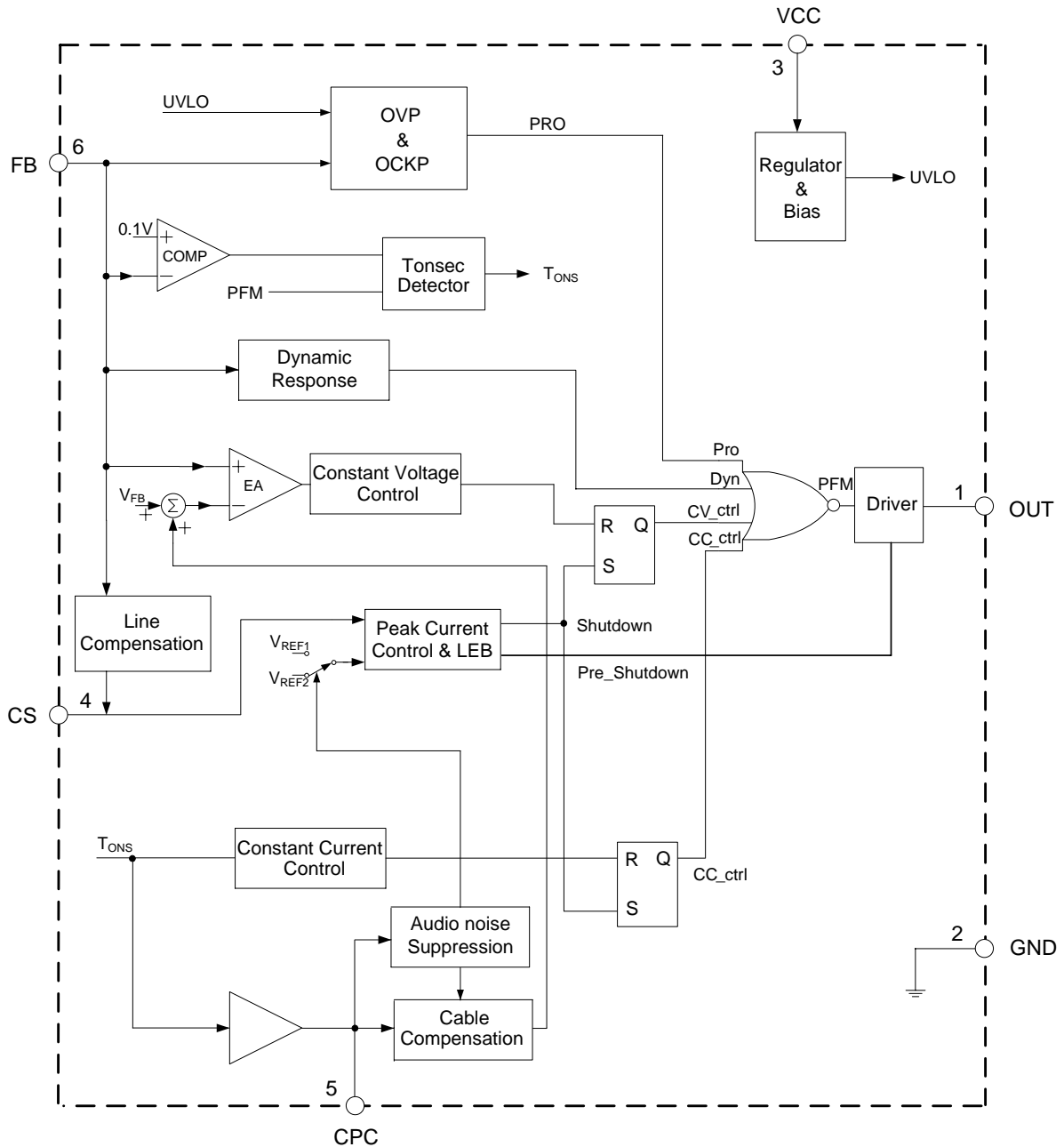
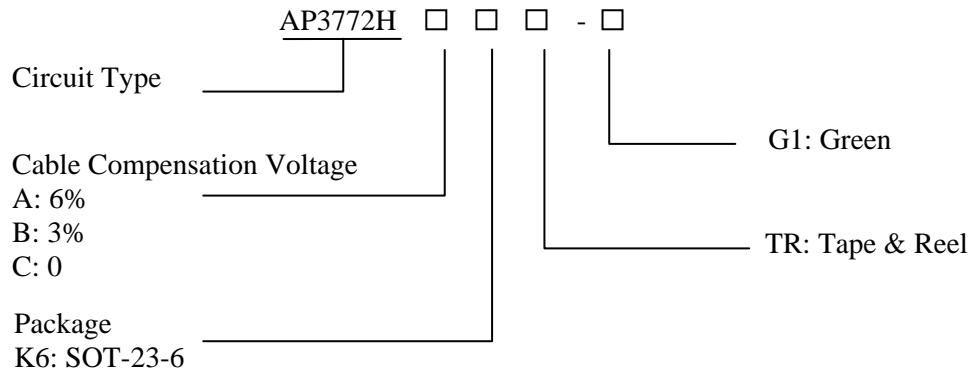

Figure 3. Functional Block Diagram of AP3772H

**Low-Power Off-line Primary Side Regulation Controller****AP3772H****Ordering Information**

Package	Temperature Range	Cable Compensation Voltage	Part Number	Marking ID	Packing Type
SOT-23-6	-40 to 85°C	6%	AP3772HAK6TR-G1	GBC	Tape & Reel
		3%	AP3772HBK6TR-G1	GKJ	Tape & Reel
		0	AP3772HCK6TR-G1	GJD	Tape & Reel

BCD Semiconductor's Pb-free products, as designated with "G1" suffix in the part number, are RoHS compliant and green.

**Absolute Maximum Ratings (Note 1)**

Parameter	Symbol	Value	Unit
Supply Voltage	$V_{CC}$	-0.3 to 30	V
CS, CPC to GND		-0.3 to 7	V
FB Input Voltage	$V_{FB}$	-40 to 10	V
Source Current at OUT Pin	$I_{SOURCE}$	Internally Limited	A
Operating Junction Temperature	$T_J$	150	°C
Storage Temperature	$T_{STG}$	-65 to 150	°C
Lead Temperature (Soldering, 10 sec)	$T_{LEAD}$	300	°C
Thermal Resistance (Junction to Ambient)	$\theta_{JA}$	200	°C/W

Note 1: Stresses greater than those listed under "Absolute Maximum Ratings" may cause permanent damage to the device. These are stress ratings only, and functional operation of the device at these or any other conditions beyond those indicated under "Recommended Operating Conditions" is not implied. Exposure to "Absolute Maximum Ratings" for extended periods may affect device reliability.



**Low-Power Off-line Primary Side Regulation Controller**

**AP3772H**

**Electrical Characteristics**

V<sub>CC</sub>=15V, T<sub>A</sub>=25°C, unless otherwise specified.

Parameter	Symbol	Conditions	Min	Typ	Max	Unit		
<b>UVLO SECTION</b>								
Startup Threshold	V <sub>TH</sub> (ST)		13	15.5	18	V		
Minimal Operating Voltage	V <sub>OPR</sub> (MIN)		3	3.5	4.5	V		
<b>STANDBY CURRENT SECTION</b>								
Startup Current	I <sub>ST</sub>	V <sub>CC</sub> =V <sub>TH</sub> (ST)-1V, Before startup	0	0.2	0.6	μA		
Operating Current	I <sub>CC</sub> (OPR)	Static current	250	500	600	μA		
<b>DRIVE OUTPUT SECTION</b>								
Output Current	Sink	I <sub>SINK</sub>	Apply 1V @ OUT pin		150	330	500	mA
	Source	I <sub>SOURCE</sub>			30	40	50	mA
Maximum Off Time	t <sub>OFF</sub> (MAX)		14	18	25	ms		
<b>CURRENT SENSE SECTION</b>								
Current Sense Threshold Voltage at Heavy Load	V <sub>CS1</sub>		500	525	550	mV		
Leading Edge Blanking	t <sub>LEB</sub>	The minimum power switch turn on time	300	500	650	ns		
<b>FEEDBACK INPUT SECTION</b>								
Input Resistance of FB Pin	R <sub>FB</sub>	V <sub>FB</sub> =4V	1	1.6	2	MΩ		
Feedback Threshold	V <sub>FB</sub>		3.98	4.04	4.1	V		
<b>LINE COMPENSATION SECTION</b>								
Line Compensation Transconductance (Note 2)	g <sub>m</sub>		0.8	1.2	1.6	μS		
<b>CABLE COMPENSATION SECTION</b>								
Cable Compensation Voltage	ΔV <sub>FB_CABLE</sub> / V <sub>FB</sub> %	AP3772HA	5	6	7	%		
		AP3772HB	2	3	4			
		AP3772HC		0				
<b>DYNAMIC FUNCTION SECTION</b>								
Delay Time for Dynamic Function	t <sub>D</sub>		110	150	200	μs		
Trigger Voltage for Dynamic Function	V <sub>TRIGGER</sub>		120	150	180	mV		
<b>PROTECTION SECTION</b>								
Over Voltage Protection	V <sub>FB</sub> (OVP)		7	8	9	V		
Maximum On Time of Primary Side	tonp (MAX)		20	35	50	μs		

Note 2: Line compensation voltage on CS pin:  $\Delta V_{CS} = V_{IN\_DC} \cdot \frac{N_{AUX}}{N_{PRI}} \cdot \frac{R_6}{R_6 + R_7} \cdot g_m \cdot R_{LINE}$



### Typical Performance Characteristics

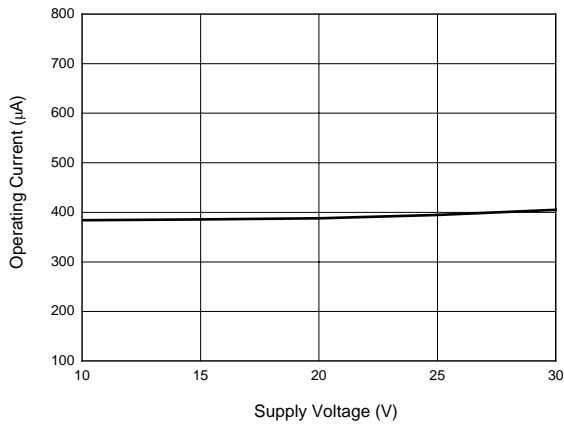

Figure 4. Operating Current vs. Supply Voltage

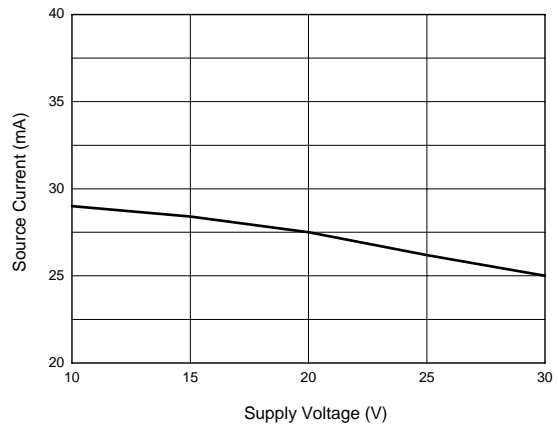

Figure 5. Source Current vs. Supply Voltage

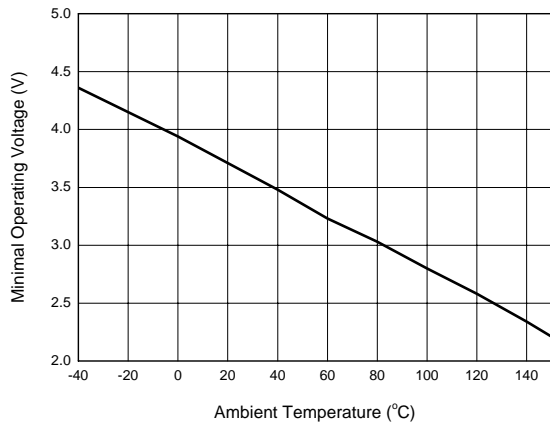

Figure 6. Minimal Operating Voltage vs. Ambient Temperature

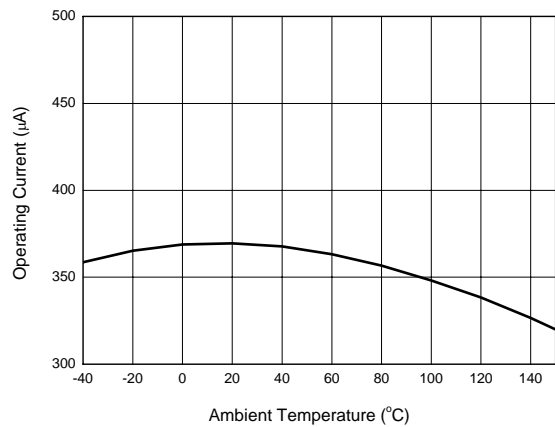

Figure 7. Operating Current vs. Ambient Temperature



Typical Performance Characteristics (Continued)

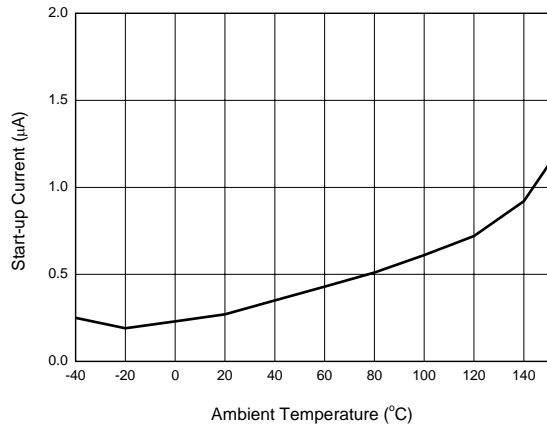

Figure 8. Start-up Current vs. Ambient Temperature

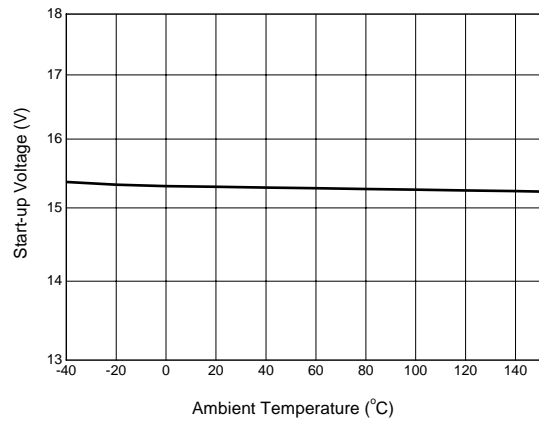

Figure 9. Start-up Voltage vs. Ambient Temperature

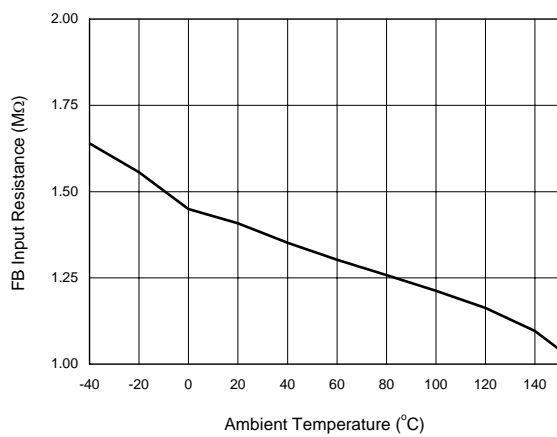

Figure 10. FB Input Resistance vs. Ambient Temperature

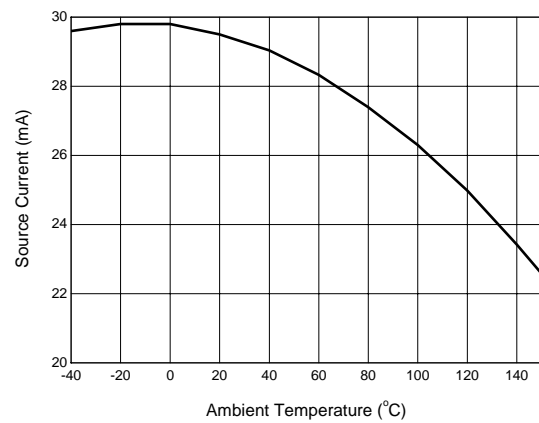

Figure 11. Source Current vs. Ambient Temperature



Typical Performance Characteristics (Continued)

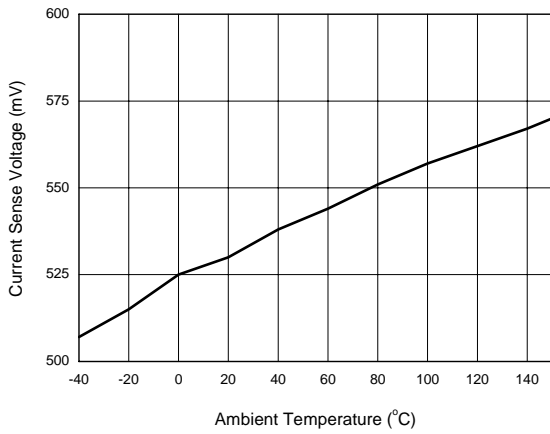

Figure 12. Current Sense Voltage vs. Ambient Temperature

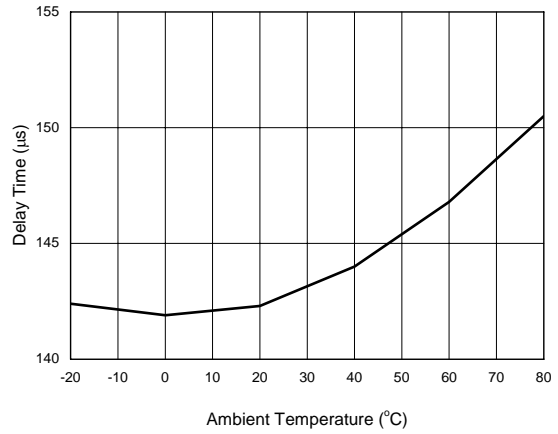

Figure 13. Delay Time vs. Ambient Temperature

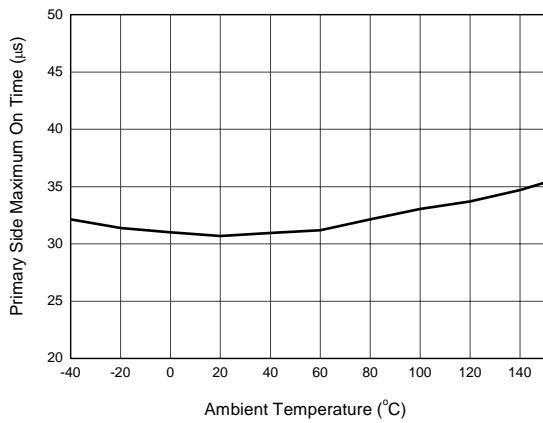

Figure 14. Primary Side Maximum On Time vs. Ambient Temperature

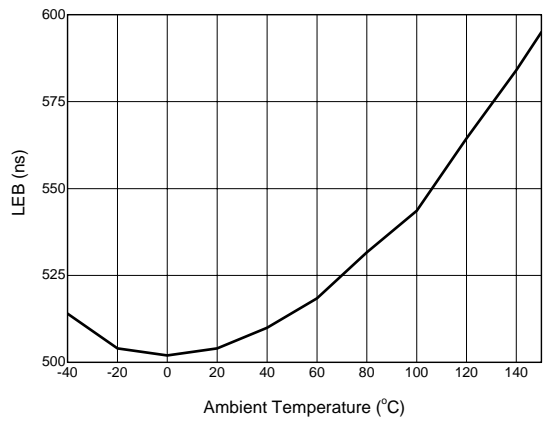

Figure 15. LEB vs. Ambient Temperature



**Typical Performance Characteristics (Continued)**

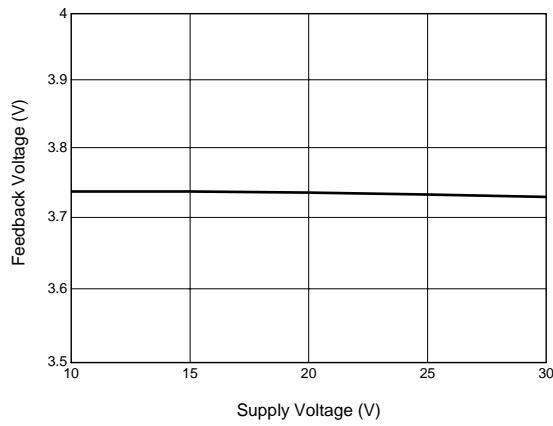

Figure 16. Feedback Voltage vs. Supply Voltage

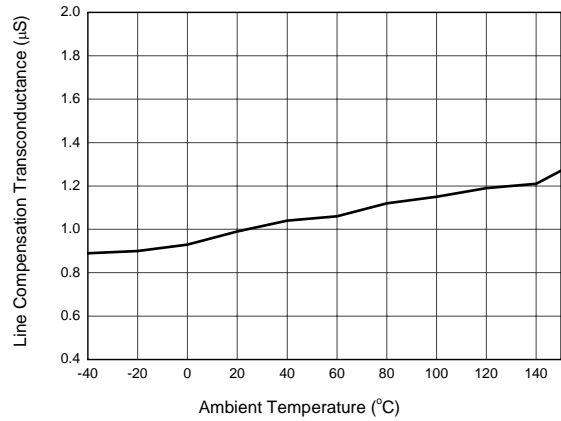

Figure 17. Line Compensation Transconductance vs. Ambient Temperature

**Typical Application**

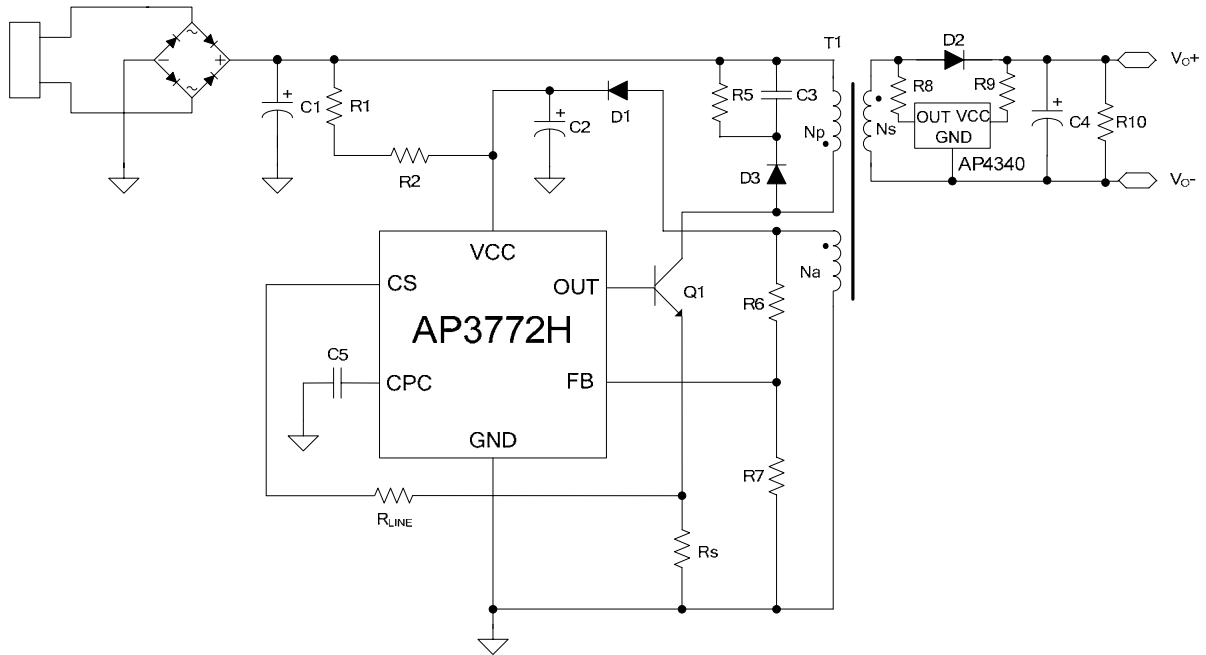
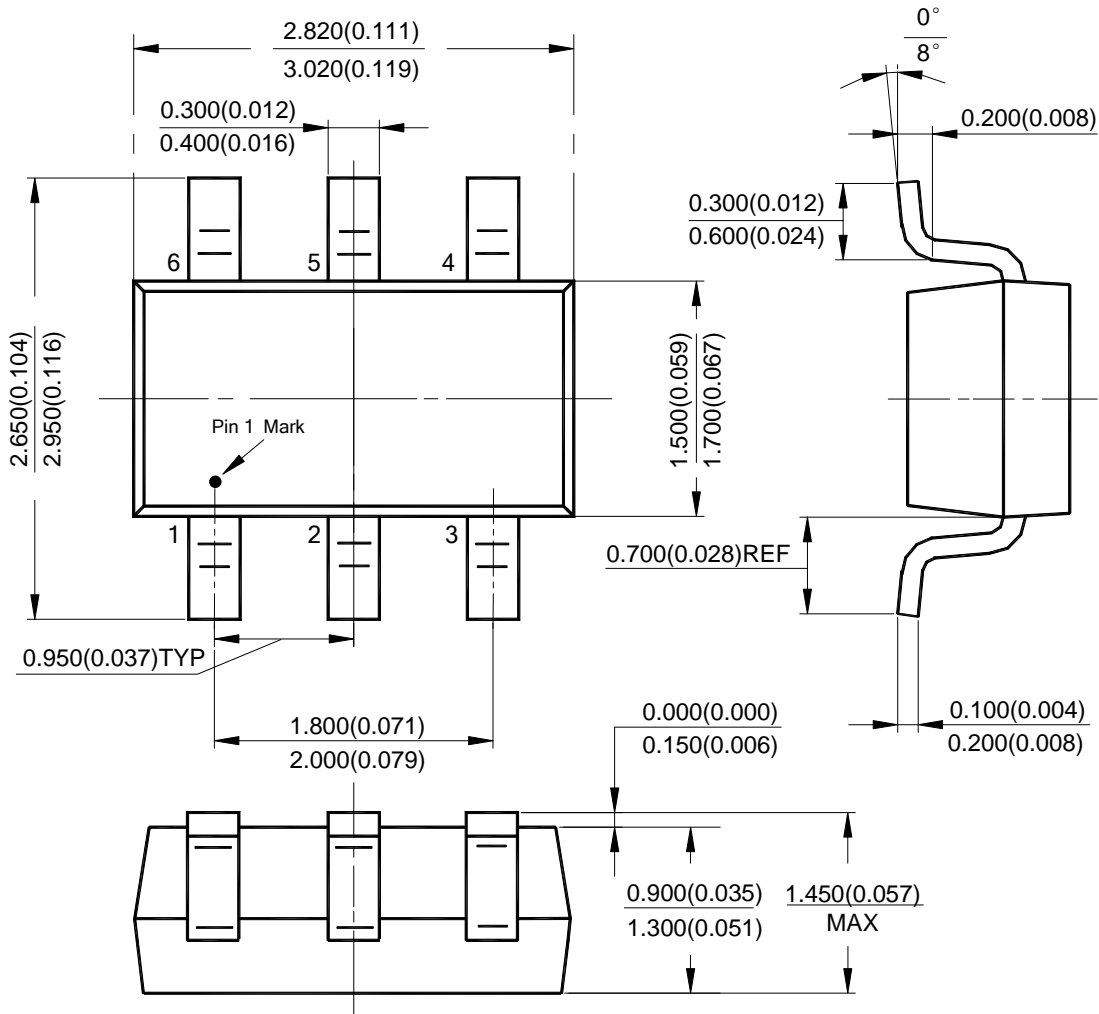

Figure 18. 5V/1A Output for Battery Charger of Mobile Phone  
(The AP4340 Is Used to Achieve Fast Dynamic Response)

**Mechanical Dimensions**

**SOT-23-6**

**Unit: mm(inch)**





## BCD Semiconductor Manufacturing Limited

<http://www.bcdsemi.com>

### IMPORTANT NOTICE

BCD Semiconductor Manufacturing Limited reserves the right to make changes without further notice to any products or specifications herein. BCD Semiconductor Manufacturing Limited does not assume any responsibility for use of any its products for any particular purpose, nor does BCD Semiconductor Manufacturing Limited assume any liability arising out of the application or use of any its products or circuits. BCD Semiconductor Manufacturing Limited does not convey any license under its patent rights or other rights nor the rights of others.

---

#### MAIN SITE

##### - Headquarters

##### BCD (Shanghai) Micro-electronics Limited

No. 1600, Zi Xing Road, Shanghai ZiZhu Science-based Industrial Park, 200241, P. R. C.  
Tel: +86-021-2416-2266, Fax: +86-021-2416-2277

##### - Wafer Fab

##### Shanghai SIM-BCD Semiconductor Manufacturing Co., Ltd.

800 Yishan Road, Shanghai 200233, China  
Tel: +021-6485-1491, Fax: +86-021-5450-0008

#### REGIONAL SALES OFFICE

##### Shenzhen Office

##### Shanghai SIM-BCD Semiconductor Manufacturing Co., Ltd., Shenzhen Office

Unit A Room 1203, Skyworth Bldg., Gaoxin Ave.1.S., Nanshan District  
Shenzhen 518057, China

Tel: +86-0755-8660-4900, Fax: +86-0755-8660-4958

##### Taiwan Office (Taipei)

##### BCD Semiconductor (Taiwan) Company Limited

3F, No.17, Lane 171, Sec. 2, Jiu-Zong Rd., Nei-Hu Dist., Taipei(114), Taiwan, R.O.C  
Tel: +886-2-2656-2808

Fax: +886-2-2656-2806/26562950

##### Taiwan Office (Hsinchu)

##### BCD Semiconductor (Taiwan) Company Limited

8F, No.176, Sec. 2, Gong-Dao 5th Road, East District  
HsinChu City 300, Taiwan, R.O.C

Tel: +886-3-5160181, Fax: +886-3-5160181

##### USA Office

##### BCD Semiconductor Corp.

48460 Kato Road, Fremont, CA 94538, USA  
Tel: +1-510-668-1950

Fax: +1-510-668-1990

##### Korea Office

##### BCD Semiconductor Limited Korea office.

Room 101-1112, Digital-Empire II, 486 Sin-dong,  
Yeongtong-Gu, Suwon-city, Gyeonggi-do, Korea

Tel: +82-31-695-8430

## Looking for pricing, stock, or lifecycle information?

Click below to explore more details on WIN SOURCE:

-  [View AP3772HBK6TR-G1 on WIN SOURCE](#)
-  [Diodes Incorporated Information](#)

## Optimize Your Supply Chain with WIN SOURCE Solutions

-  Global Sourcing Solution
-  Obsolete Management
-  Cost Control Management
-  Shortage Management
-  Alternative Solution
-  Excess Inventory Management