



**THE DATASHEET OF
NCV8509PDW25**



NCV8509 Series

Voltage Regulator - Sequenced Linear, Dual

The NCV8509 Series are dual voltage regulators whose output voltages power up in such a manner as to protect the integrity of modern day microcontroller I/O and ESD input structures. Newer generation microcontrollers require two power supplies. One voltage is used for powering the core, while the other powers the I/O.

Features

- Power-Up Sequence
- Output Voltage Options:
 - ◆ V_{OUT1} 5 V ($\pm 2\%$) 115 mA, V_{OUT2} 2.6 V (2%) 100 mA
 - ◆ V_{OUT1} 5 V ($\pm 2\%$) 115 mA, V_{OUT2} 2.5 V (2%) 100 mA
 - ◆ V_{OUT1} 3.3 V ($\pm 2\%$) 115 mA, V_{OUT2} 1.8 V (2%) 100 mA
- Low 175 μ A Quiescent Current
- Power Shunt
- Programmable $\overline{\text{RESET}}$ Time
- Dual Drive $\overline{\text{RESET}}$ Valid
- Programmable SLEW Rate Control
- Thermal Shutdown
- 16 Lead SOW Exposed Pad
- NCV Prefix, for Automotive and Other Applications Requiring Site and Change Control
- AEC Qualified
- PPAP Capable
- These are Pb-Free Devices

Typical Applications

- Automotive Powertrain
- Telematics

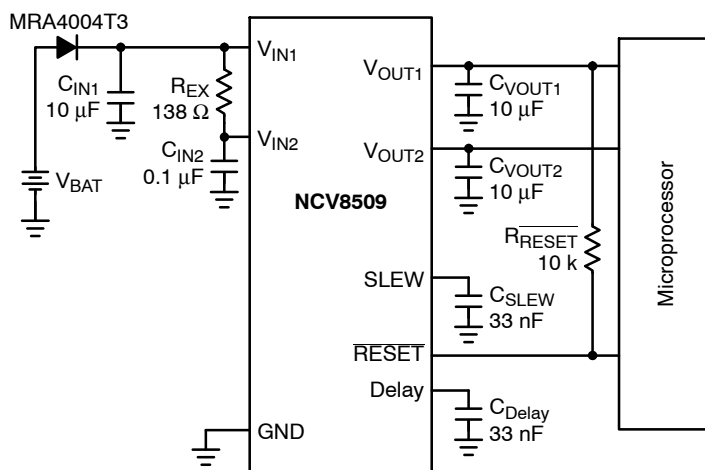
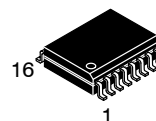

Figure 1. Application Diagram



ON Semiconductor®

<http://onsemi.com>



SOIC 16 LEAD
WIDE BODY
EXPOSED PAD
PDW SUFFIX
CASE 751AG

MARKING DIAGRAM

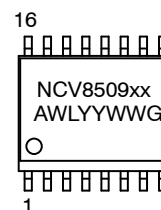

xx = Voltage Ratings as Indicated

Below:

26 = 5 V/2.6 V
25 = 5 V/2.5 V
18 = 3.3 V/1.8 V

A = Assembly Location
WL = Wafer Lot
YY = Year
WW = Work Week
G = Pb-Free Device

PIN CONNECTIONS

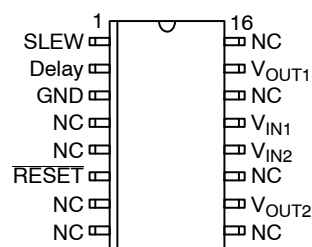

ORDERING INFORMATION

See detailed ordering and shipping information in the package dimensions section on page 17 of this data sheet.

NCV8509 Series

MAXIMUM RATINGS

Rating	Value	Unit
V_{IN1} (dc)	-0.3 to 50	V
V_{IN1} Peak Transient Voltage	50	V
V_{IN2} (dc)	50	V
V_{IN2} (Current out of pin)	10	mA
Operating Voltage	50	V
Input Voltage Range (SLEW, RESET, Delay)	-0.3 to 10	V
V_{OUT1}	10	V
V_{OUT2}	10	V
Electrostatic Discharge (Human Body Model) (Machine Model)	4.0 400	kV V
Package Thermal Resistance, SOW-16 E Pad: Junction-to-Case, $R_{\theta JC}$ Junction-to-Ambient, $R_{\theta JA}$	16 57	$^{\circ}C/W$ $^{\circ}C/W$
Lead Temperature Soldering: Reflow: (SMD styles only) (Note 1)	240 peak (Note 2)	$^{\circ}C$

Stresses exceeding Maximum Ratings may damage the device. Maximum Ratings are stress ratings only. Functional operation above the Recommended Operating Conditions is not implied. Extended exposure to stresses above the Recommended Operating Conditions may affect device reliability.

- 60 second maximum above 183°C.
- 5°C/+0°C allowable conditions.

ELECTRICAL CHARACTERISTICS (6.0 V < V_{IN1} < 18 V, I_{VOUT1} = 5.0 mA, I_{VOUT2} = 5.0 mA, -40°C < T_J < 125°C, C_{VOUT1} = C_{VOUT2} = 10 μF ; unless otherwise noted.)

Characteristic	Test Conditions	Min	Typ	Max	Unit
----------------	-----------------	-----	-----	-----	------

V_{OUT1}

Output Voltage 5 V Option	1.0 mA < I_{VOUT1} < 100 mA	4.9	5.0	5.1	V
3.3 V Option	1.0 mA < I_{VOUT1} < 100 mA	3.234	3.3	3.366	V
Dropout Voltage ($V_{IN1} - V_{OUT1}$)	$I_{OUT} = 100$ mA	-	400	600	mV
	$I_{OUT} = 100$ μA	-	100	200	mV
Load Regulation	1.0 mA < I_{VOUT1} < 100 mA	-	10	50	mV
Line Regulation	6.0 V < V_{IN1} < 18 V	-	10	50	mV
Current Limit	$V_{OUT1} = V_{OUT1}$ (typ) - 500 mV	115	305	610	mA
	$V_{OUT1} = 0$ V	-	105	300	mA

V_{OUT2}

Output Voltage 2.6 V Option	1.0 mA < I_{VOUT2} < 100 mA	2.548	2.6	2.652	V
2.5 V Option	1.0 mA < I_{VOUT2} < 100 mA	2.450	2.5	2.550	V
1.8 V Option	1.0 mA < I_{VOUT2} < 100 mA	1.764	1.8	1.836	V
Load Regulation	1.0 mA < I_{VOUT2} < 100 mA	-	5.0	50	mV
Line Regulation	6.0 V < $V_{IN1} = V_{IN2}$ < 18 V	-	10	50	mV
Current Limit	$V_{OUT2} = V_{OUT2}$ (typ) - 500 mV	105	305	610	mA
	$V_{OUT2} = 0$ V	-	105	300	mA

General

Quiescent Current	$I_{OUT1} = I_{OUT2} = 100$ μA , $V_{IN1} = 12$ V	-	125	175	μA
	$I_{OUT1} = I_{OUT2} = 50$ mA, $V_{IN1} = 14$ V	-	5.0	10	mA
Thermal Shutdown (Note 3)	(Guaranteed by Design)	150	180	210	$^{\circ}C$

- Both outputs will turn off.

NCV8509 Series

ELECTRICAL CHARACTERISTICS (continued) (6.0 V < V_{IN1} < 18 V, I_{OUT1} = 5.0 mA, I_{OUT2} = 5.0 mA, -40°C < T_J < 125°C, C_{VOUT1} = C_{VOUT2} = 10 μF; unless otherwise noted.)

Characteristic	Test Conditions	Min	Typ	Max	Unit
SLEW					
SLEW Charging Current	SLEW = 1.0 V	4.0	6.0	8.0	μA
V _{OUT1} SLEW Rate (Note 4)	C _{SLEW} = 33 nF				
5 V Option		-	710	-	V/s
3.3 V Option		-	469	-	V/s
V _{OUT2} SLEW Rate	C _{SLEW} = 33 nF				
2.6 V Option		-	370	-	V/s
2.5 V Option		-	355	-	V/s
1.8 V Option		-	256	-	V/s
SLEW Control Threshold	(See Figure 53)	1.5	1.8	2.1	V

RESET

RESET Threshold Increasing (Note 5)	-	94.5	96.5	98.5	%
RESET Threshold Decreasing	-				
5 V Option		4.5	4.73	0.965 × V _{OUT}	V
3.3 V Option		2.97	3.12	0.965 × V _{OUT}	V
2.6 V Option		2.34	2.46	0.965 × V _{OUT}	V
2.5 V Option		2.25	2.36	0.965 × V _{OUT}	V
1.8 V Option		1.62	1.70	0.965 × V _{OUT}	V
RESET Output Low	I _{RESET} = 1.0 mA	-	0.1	0.4	V
RESET Output Peak	Power Down (See Figure 41)	-	0.6	1.0	V
RESET Threshold Hysteresis	-				
5 V Option		50	100	150	mV
3.3 V Option		33	66	99	mV
2.6 V Option		26	52	78	mV
2.5 V Option		25	50	75	mV
1.8 V Option		18	36	54	mV

Delay

Delay Switching Threshold	-	1.125	1.5	1.875	V
Delay Charge Current	Delay = 1.0 V	4.0	6.0	8.0	μA
Delay Saturation Voltage	V _{OUT1} Out of Regulation	-	-	0.1	V
Delay Discharge Current	Delay = 5.0 V V _{OUT1} out of Regulation	10	-	-	mA

Output Tracking

Delta 1 [V _{OUT1} - V _{OUT2}]					
5 V Option	C _{OUT1} = C _{OUT2} , I _{OUT1} = I _{OUT2}	-	-	3.2	V
3.3 V Option	C _{OUT1} = C _{OUT2} , I _{OUT1} = I _{OUT2}	-	-	2.8	V
Delta 2 [V _{OUT2} - V _{OUT1}]	C _{OUT1} = C _{OUT2} , I _{OUT1} = I _{OUT2}	-	-	100	mV

Power Shunt

Shunt Voltage 1 (V _{IN2})	V _{IN1} = 6.0 V, I _{OUT2} = 100 mA, No R _{EX}	3.3	-	4.6	V
Shunt Voltage 2 (V _{IN2})	V _{IN1} = 12 V, 1.0 mA < I _{OUT2} < 100 mA, No R _{EX}	3.25	4.5	5.75	V

4. Not a tested parameter.

5. RESET signal sensitive to V_{OUT1} and V_{OUT2}.

NCV8509 Series

PIN DESCRIPTION

Pin No.	Symbol	Description
1	SLEW	Control for output rise time during power up. Requires capacitor to ground.
2	Delay	Timing capacitor for RESET function.
3	GND	Ground.
4, 5, 7-9, 11, 14, 16	NC	No connection.
6	RESET	Active reset (accurate to $V_{OUT} > 1.0\text{ V}$).
10	V_{OUT2}	100 mA output ($\pm 2\%$ output voltage) for powering microprocessor core.
12	V_{IN2}	Input voltage for V_{OUT2} .
13	V_{IN1}	Input voltage for V_{OUT1} , and internal circuitry.
15	V_{OUT1}	100 mA output ($\pm 2\%$ output voltage) for powering microprocessor I/O.

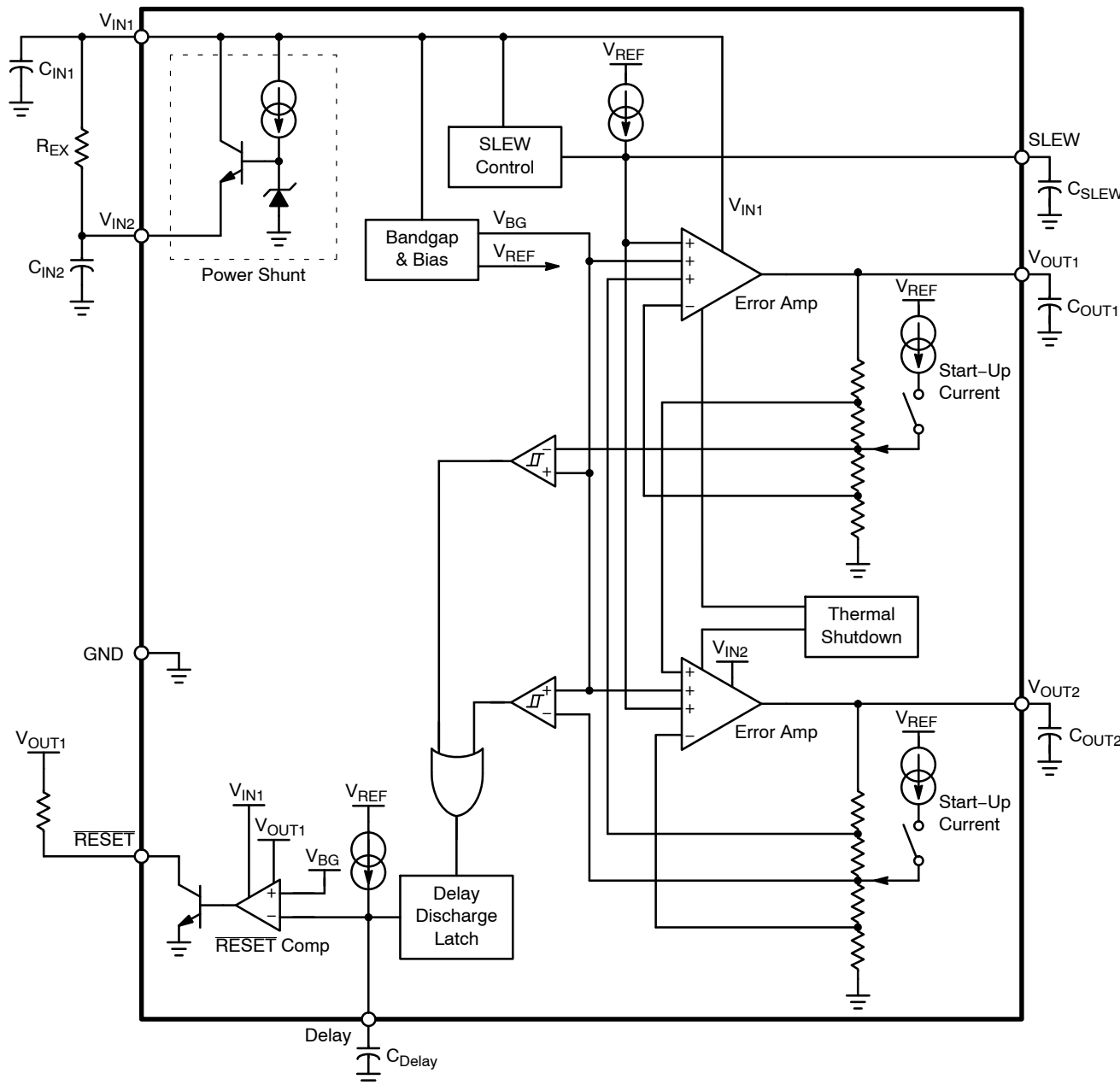

Figure 2. Block Diagram

TYPICAL PERFORMANCE CHARACTERISTICS

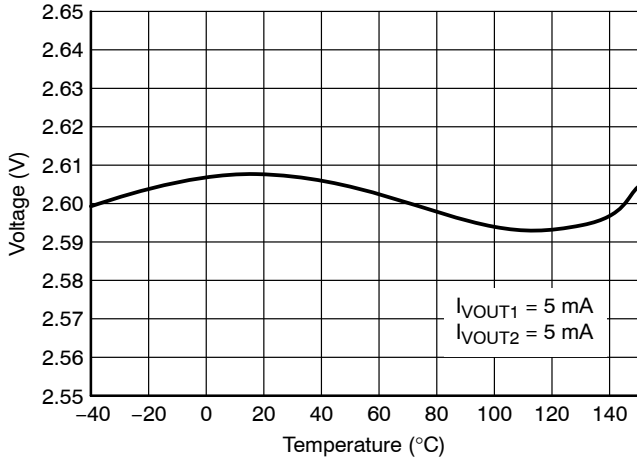

Figure 3. 2.6 V Output Voltage

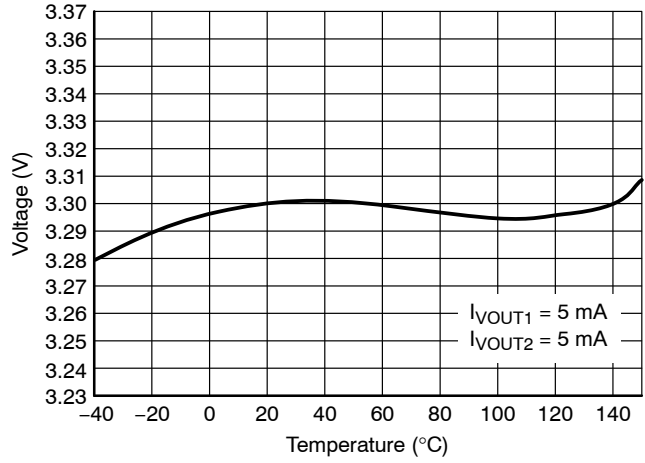

Figure 4. 3.3 V Output Voltage

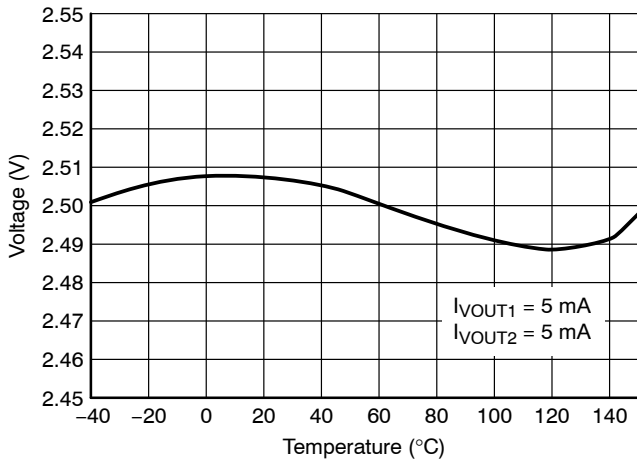

Figure 5. 2.5 V Output Voltage

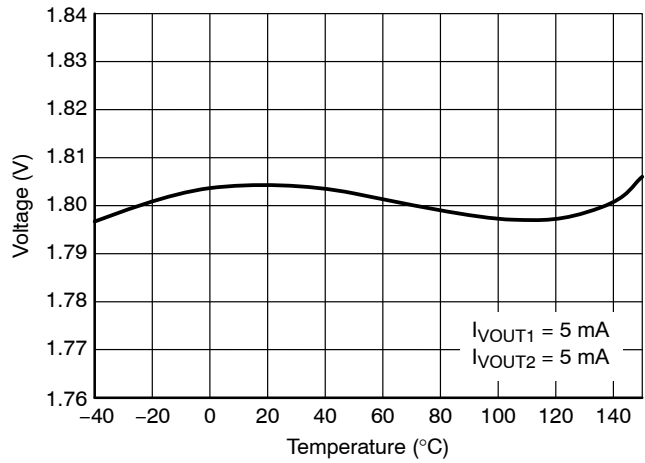

Figure 6. 1.8 V Output Voltage

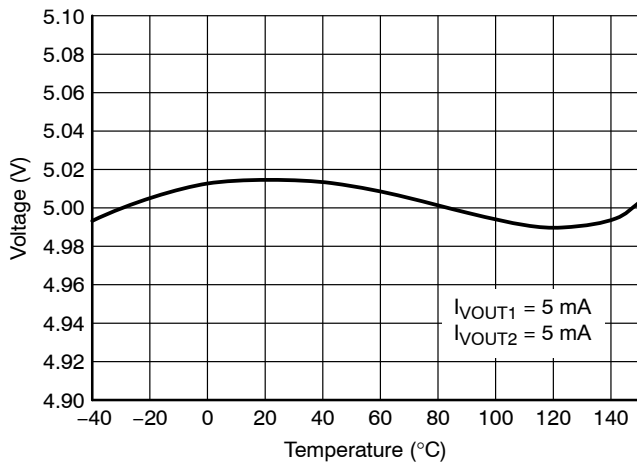

Figure 7. 5.0 V Output Voltage

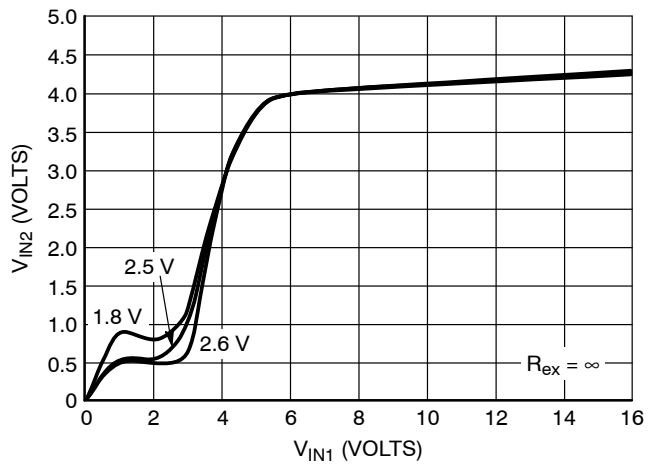

Figure 8. V_{IN2} versus V_{IN1}

TYPICAL PERFORMANCE CHARACTERISTICS

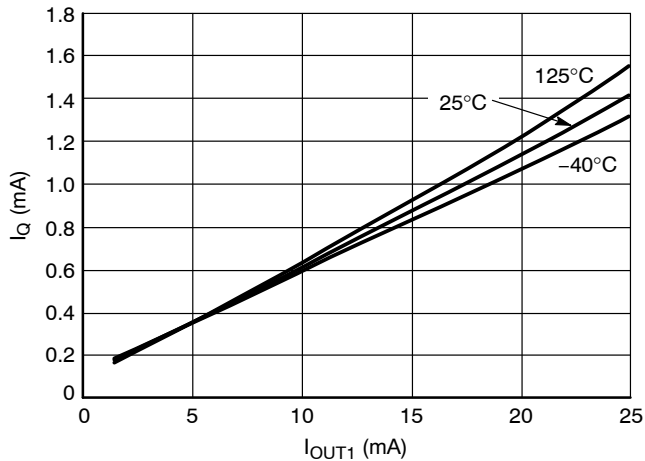

Figure 9. I_Q versus I_{OUT1}

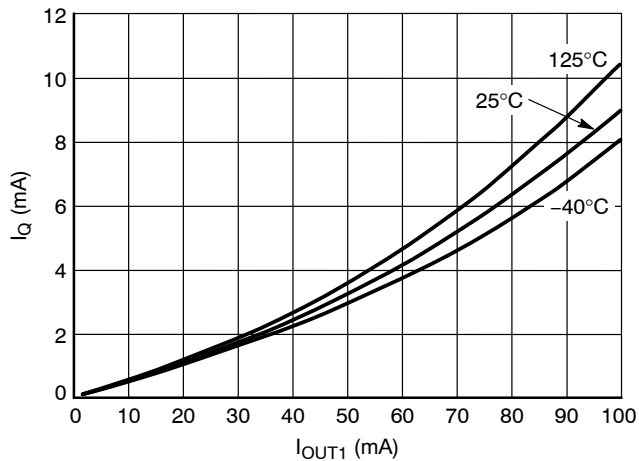

Figure 10. I_Q versus I_{OUT1}

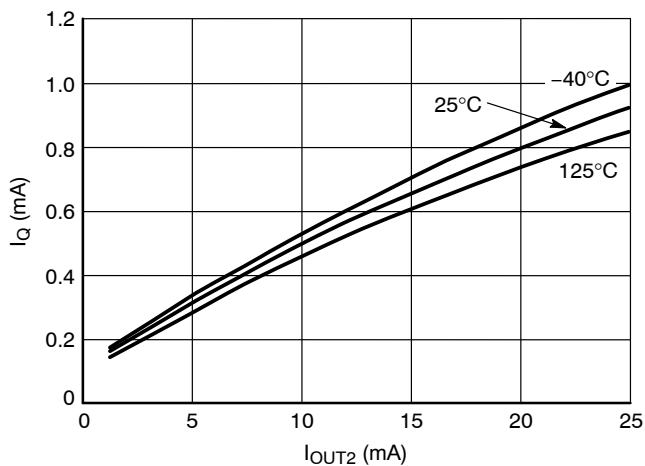

Figure 11. I_Q versus I_{OUT2}

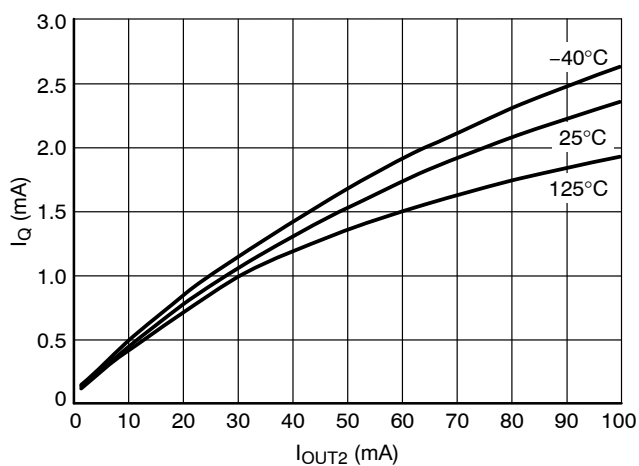

Figure 12. I_Q versus I_{OUT2}

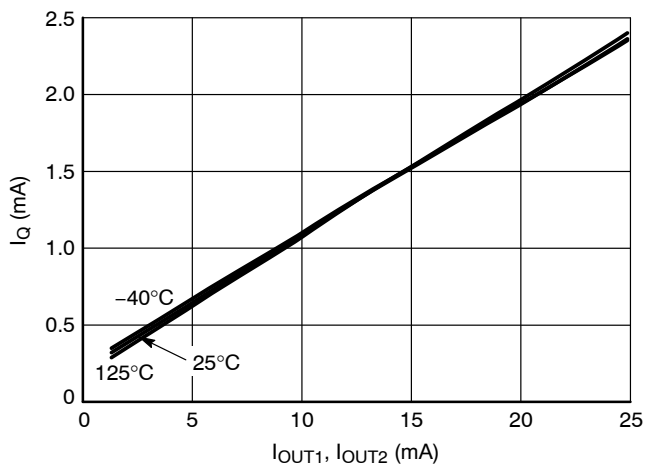

Figure 13. I_Q versus I_{OUT}
(V_{OUT1} & V_{OUT2})

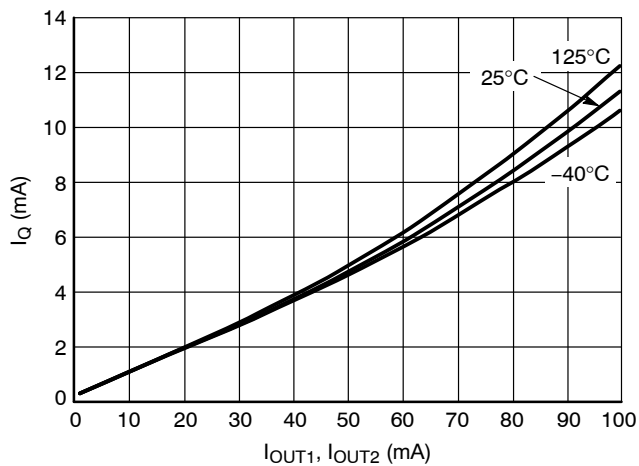

Figure 14. I_Q versus I_{OUT}
(V_{OUT1} & V_{OUT2})

TYPICAL PERFORMANCE CHARACTERISTICS

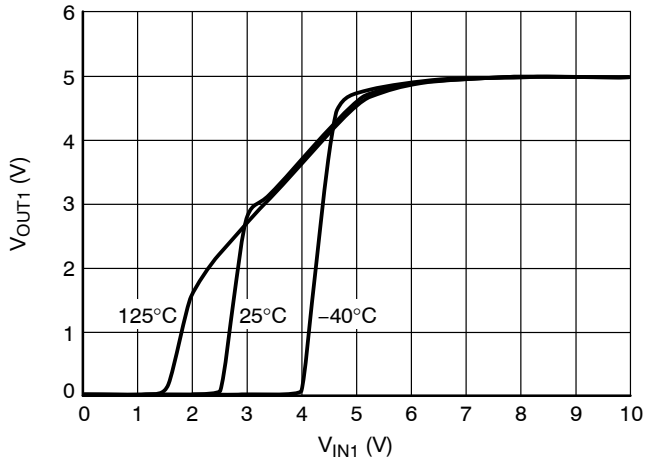

Figure 15. V_{OUT1} (5 V) versus V_{IN1}

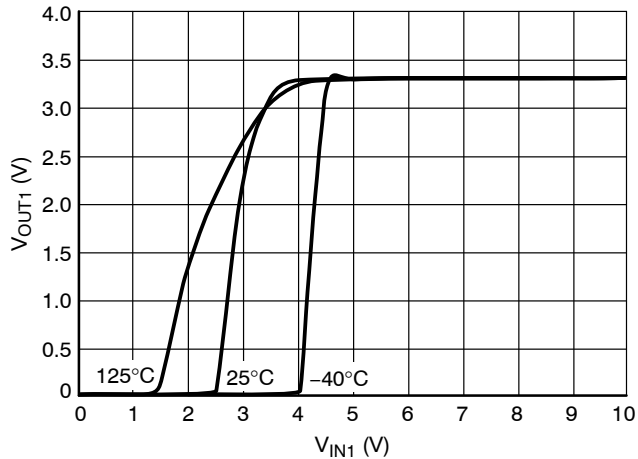

Figure 16. V_{OUT1} (3.3 V) versus V_{IN1}

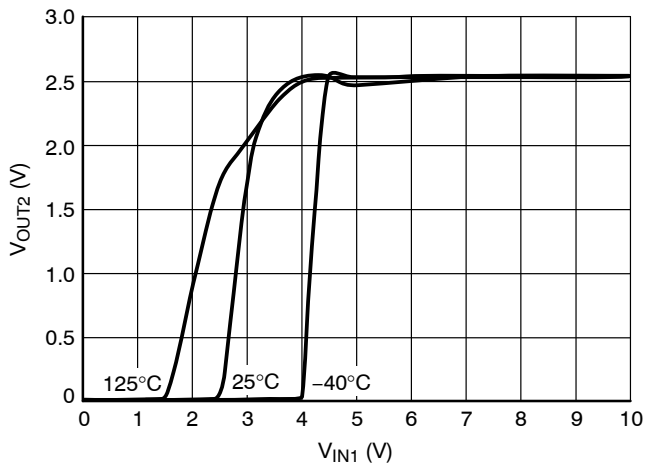

Figure 17. V_{OUT2} (2.6 V) versus V_{IN1}

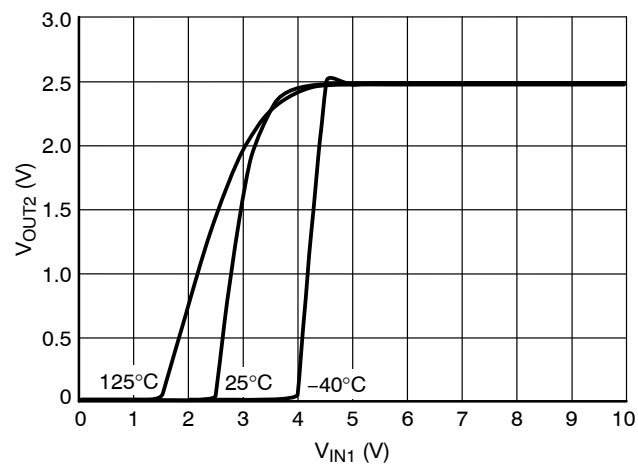

Figure 18. V_{OUT2} (2.5 V) versus V_{IN1}

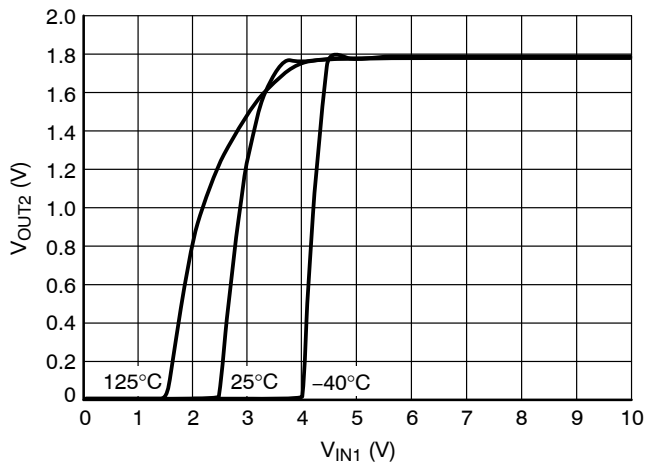

Figure 19. V_{OUT2} (1.8 V) versus V_{IN1}

TYPICAL PERFORMANCE CHARACTERISTICS

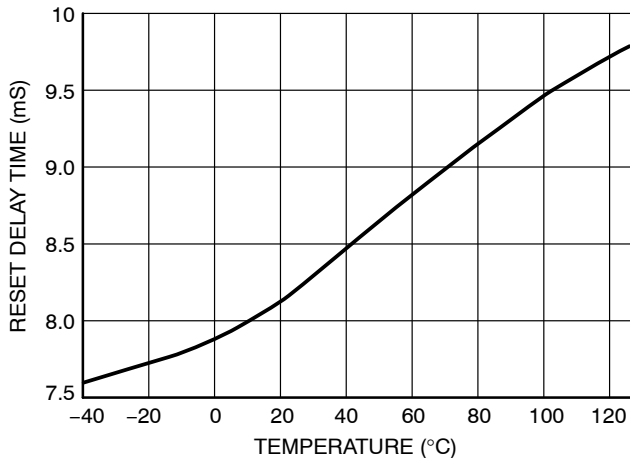

Figure 20. Reset Delay Time versus Temperature

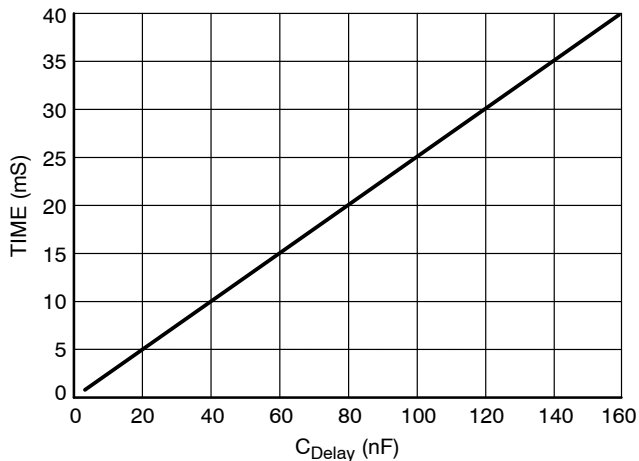

Figure 21. Reset Delay Time versus C_{Delay}

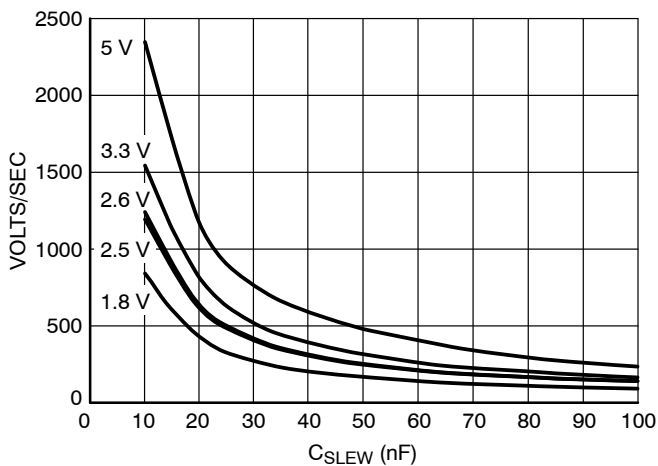

Figure 22. Slew Rate versus C_{Slew}

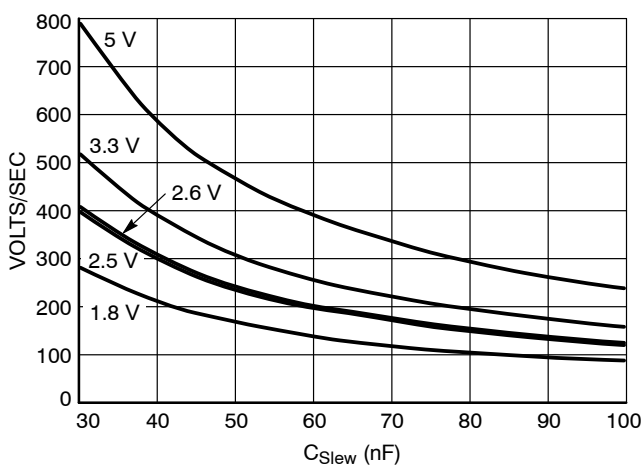

Figure 23. Slew Rate versus C_{Slew}

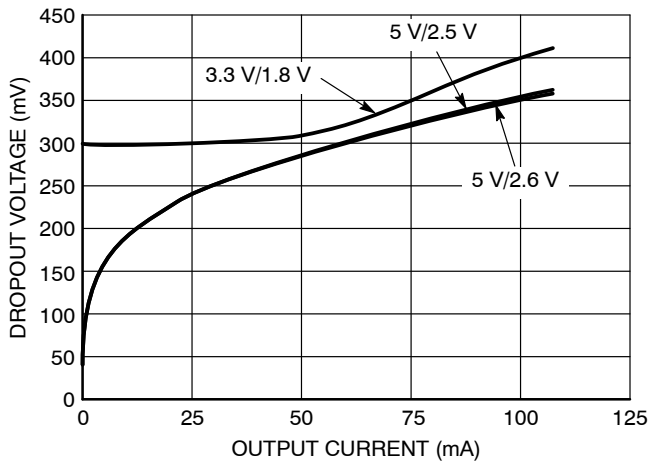

Figure 24. V_{OUT1} Dropout Voltage

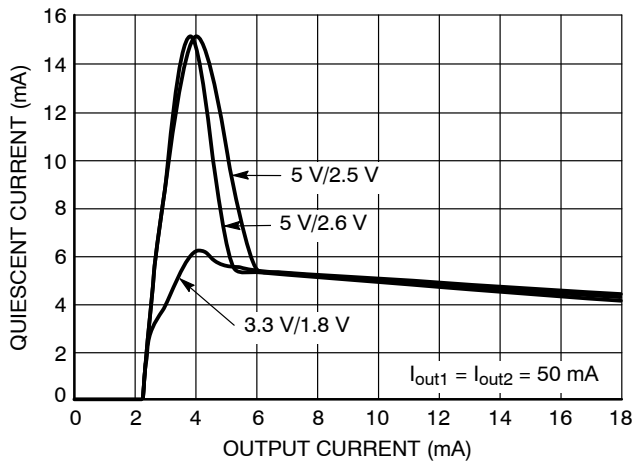

Figure 25. Quiescent Current vs. V_{IN1}

TYPICAL PERFORMANCE CHARACTERISTICS

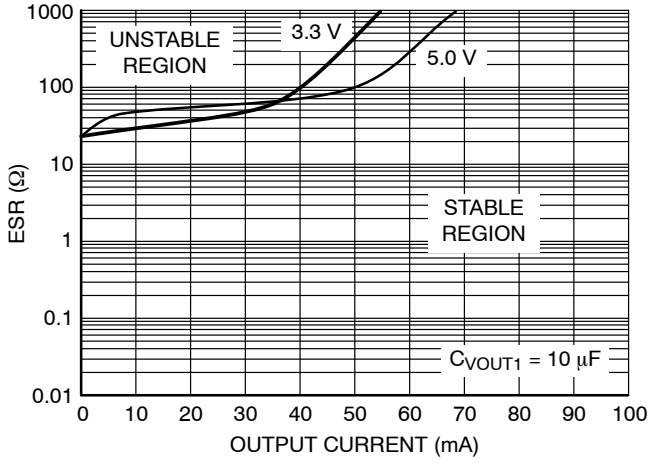

Figure 26. V_{OUT1} Output Capacitor ESR (10 μF)

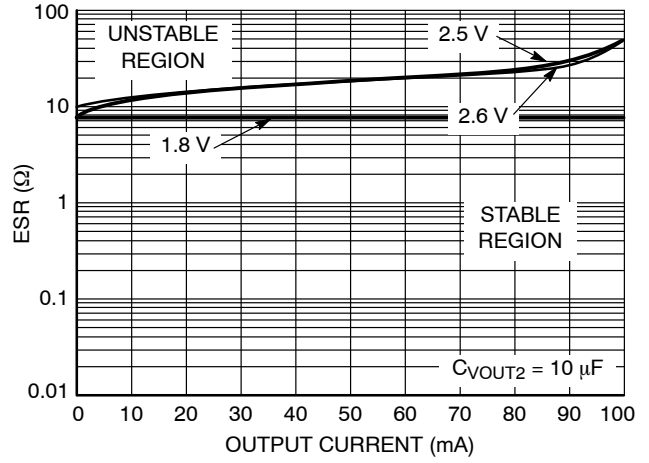

Figure 27. V_{OUT2} Output Capacitor ESR (10 μF)

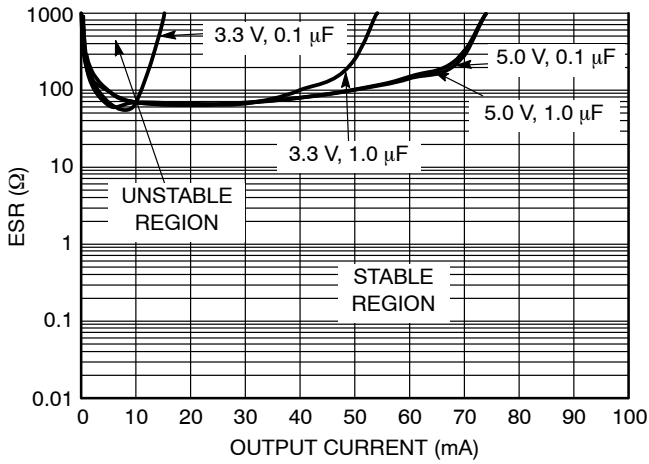

Figure 28. V_{OUT1} Output Capacitor ESR (0.1 μF / 1 μF)

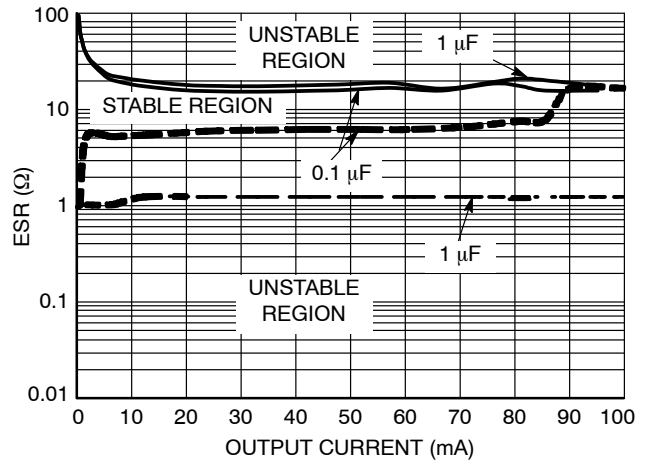

Figure 29. V_{OUT2} (2.6 V) Output Capacitor ESR (0.1 μF / 1 μF)

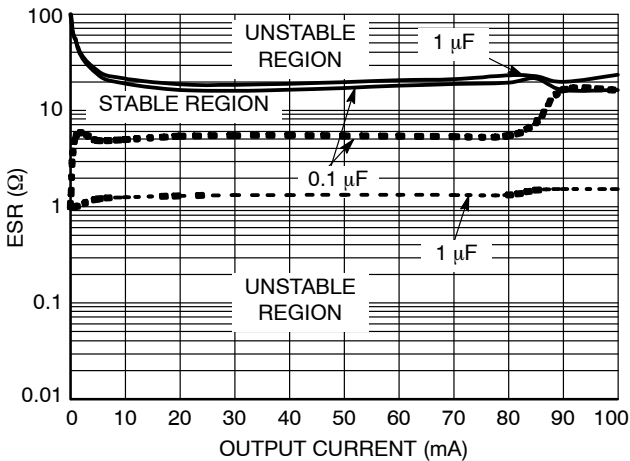

Figure 30. V_{OUT2} (2.5 V) Output Capacitor ESR (0.1 μF / 1 μF)

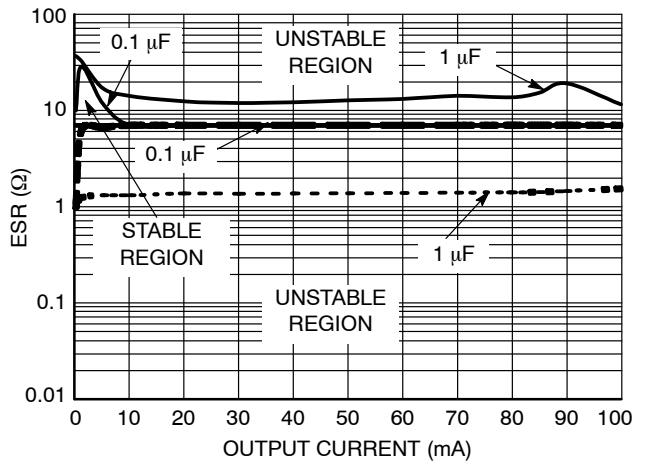

Figure 31. V_{OUT2} (1.8 V) Output Capacitor ESR (0.1 μF / 1 μF)

TYPICAL PERFORMANCE CHARACTERISTICS

(Load Transient waveforms shown were measured on the 5 V/2.6 V device)

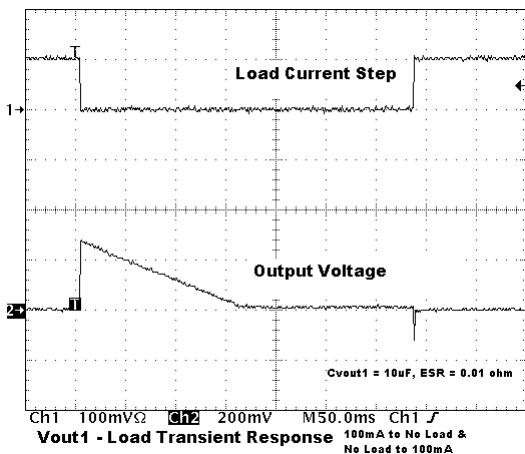

Figure 32. V_{OUT1} Load Transient Response 100 mA to No Load & No Load to 100 mA

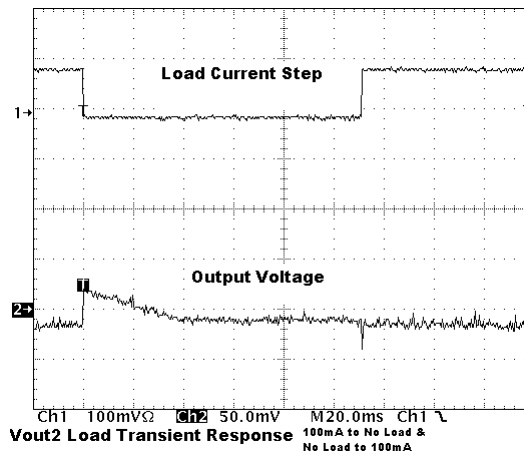

Figure 33. V_{OUT2} Load Transient Response 100 mA to No Load & No Load to 100 mA

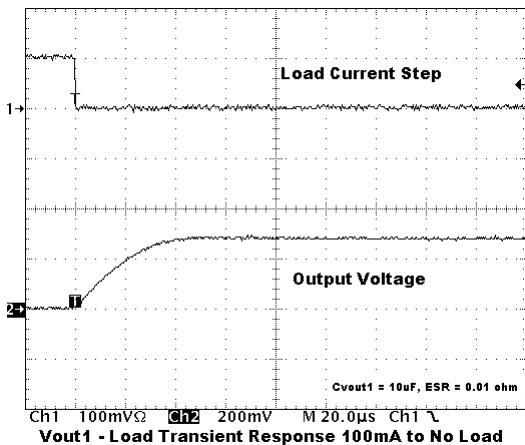

Figure 34. V_{OUT1} Load Transient Response 100 mA to No Load

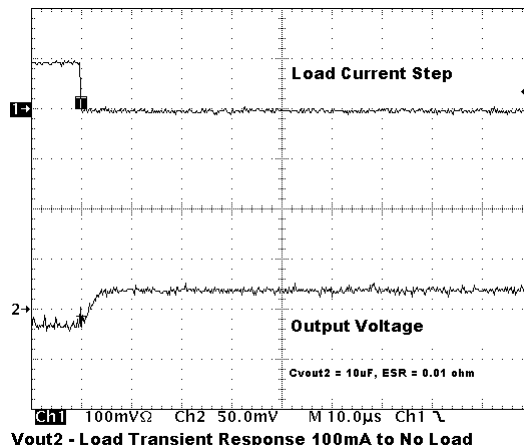

Figure 35. V_{OUT2} Load Transient Response 100 mA to No Load

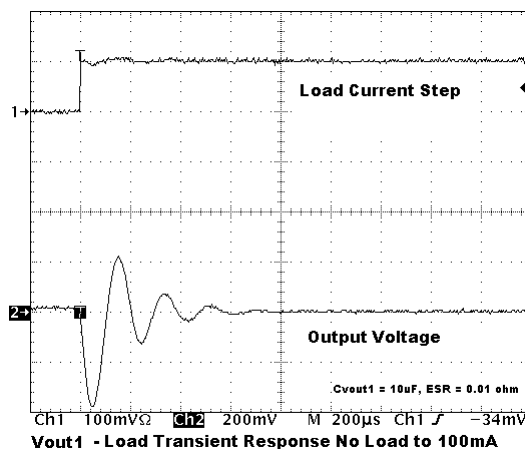

Figure 36. V_{OUT1} Load Transient Response No Load to 100 mA

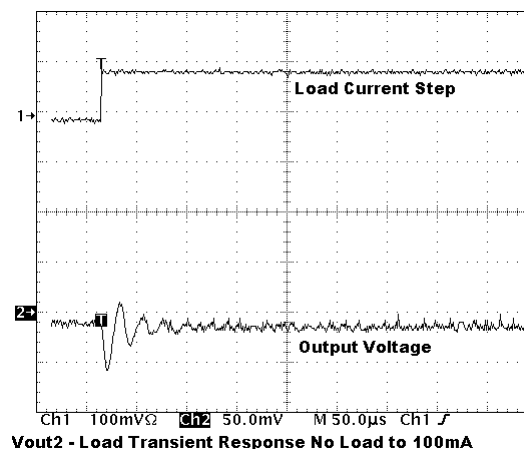

Figure 37. V_{OUT2} Load Transient Response No Load to 100 mA

NCV8509 Series

TIMING DIAGRAMS

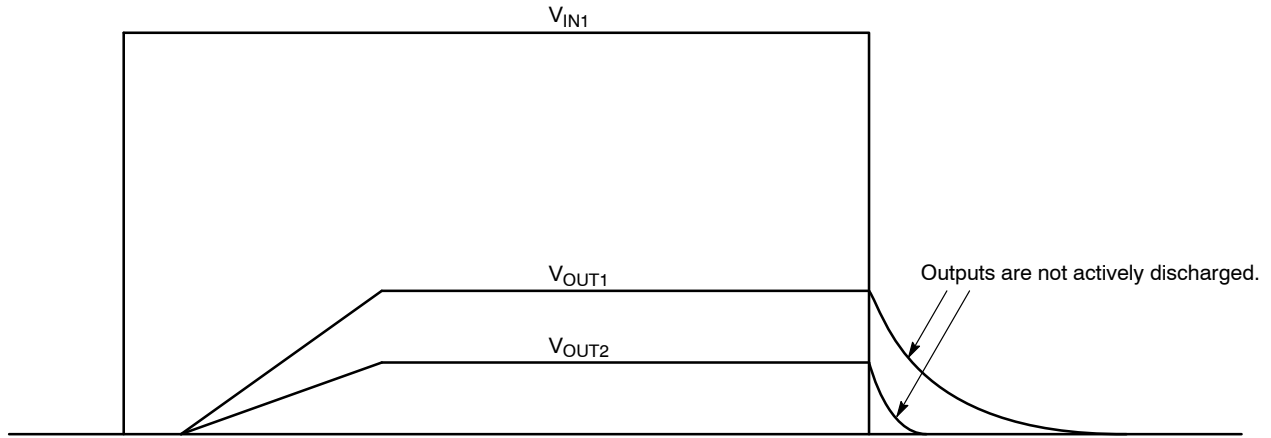

Figure 38. Response to Impulse

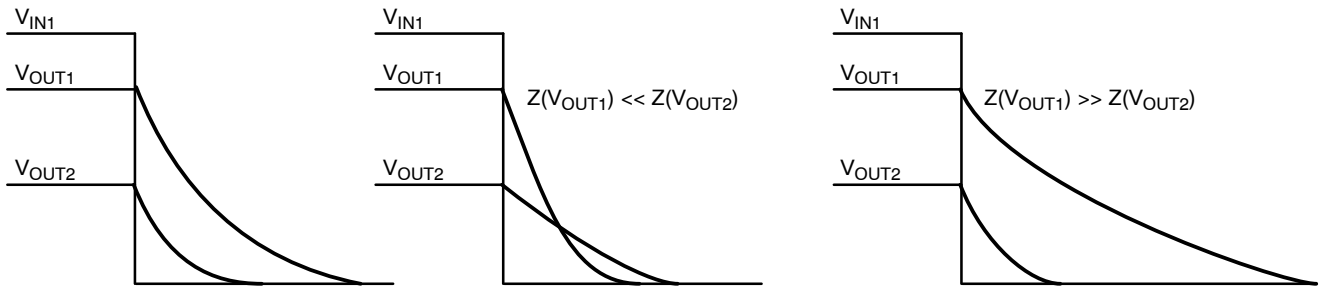

Figure 39. Output Decay vs. Load Impedance

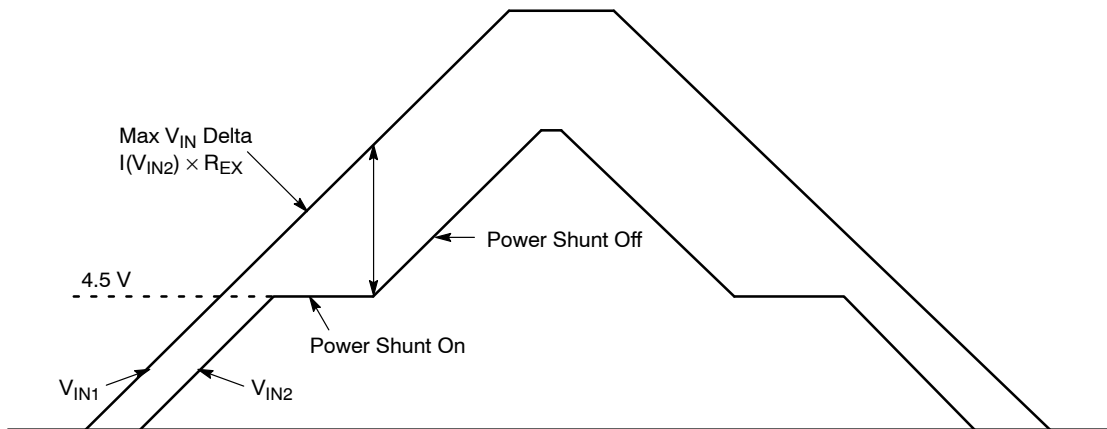

Figure 40. V_{IN} Power Shunt

CIRCUIT DESCRIPTION

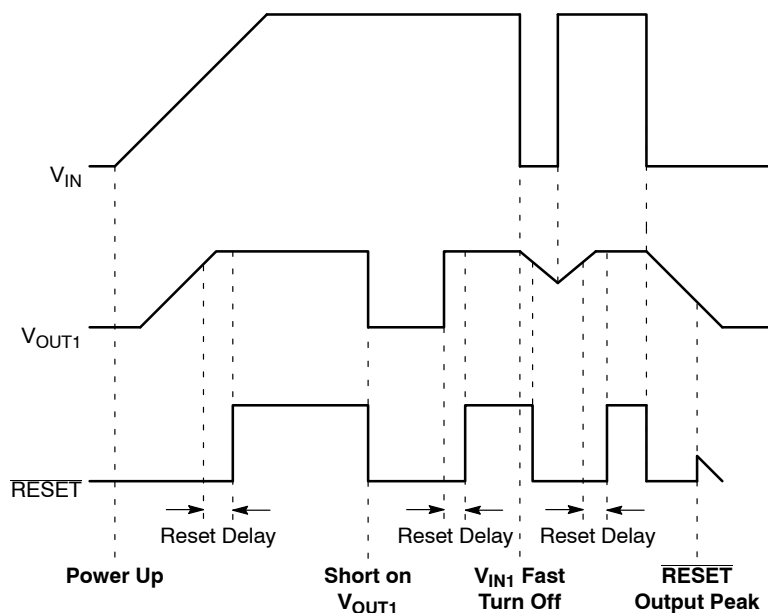

Figure 41. Dual Drive \overline{RESET} Valid

RESET

The \overline{RESET} function gets its drive from both the input (V_{IN1}) and the output (V_{OUT1}). Because of this, it is able to maintain a more reliable reset valid signal. Most regulators maintain a valid reset signal down to 1 V on the output voltage. The reset on the NCV8509 is valid down to 0 V on the output voltage V_{OUT1} (power is provided via V_{IN1}) and the reset on the NCV8509 is valid down to 0 V on the input voltage V_{IN1} (power is provided via V_{OUT1}). Refer to Figure 41 for operation timing diagrams.

Delay Function

The reset delay circuit provides a programmable (by external capacitor) delay on the \overline{RESET} output lead.

The delay lead provides source current (typically 6.0 μA) to the external delay capacitor during the following proceedings:

1. During power up (once the regulation threshold has been verified);
2. After a reset event has occurred and the device is back in regulation.

The delay capacitor is discharged when the regulation (\overline{RESET} threshold) has been violated. This is a latched incident. The capacitor will fully discharge and wait for the device to regulate before going through the delay time event again.

Power Shunt

R_{EX} routes some of the current used in the V_{OUT2} to a second input pin (V_{IN2}). This is accomplished by using an internal shunt. A simplified version of this shunt is shown in Figure 42. This has the effect of reducing the amount of power dissipated on chip. The effects of choosing the external resistor value are shown in Figure 43.

Selection of the optimum R_{EX} resistor value can be done using the following equation:

$$\frac{(V_{in(max)} - 4.5)}{I_{out2(max)}}$$

When not using the power shunt, short V_{IN1} to V_{IN2} .

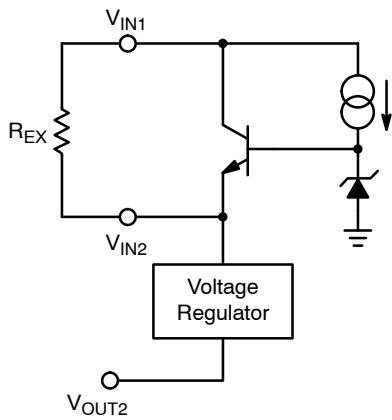

Figure 42. Power Shunt

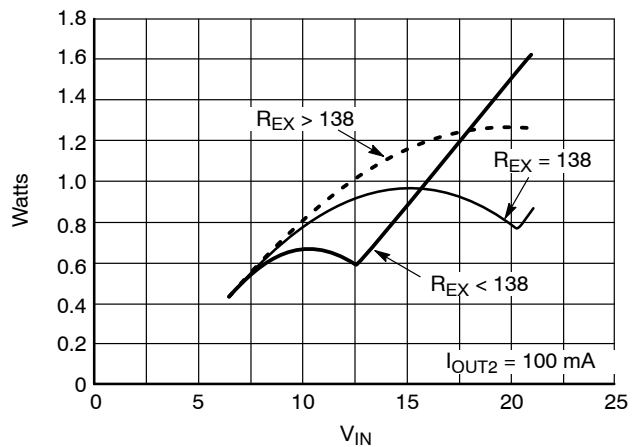

Figure 43. Power On Chip

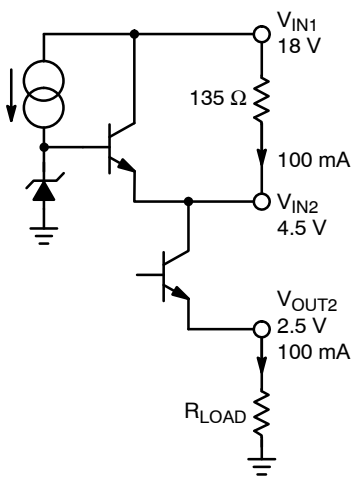

Figure 44.

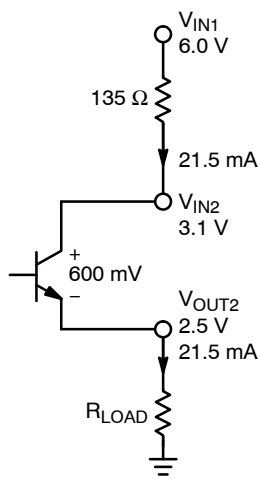

Figure 45.

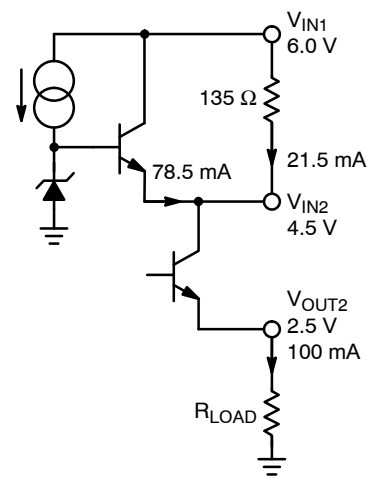

Figure 46.

Why Use a Power Shunt?

The power shunt circuitry helps manage and optimize power dissipation on the integrated circuit.

Figure 44 shows a 100 mA load. A 135 Ω resistor dissipates 1.35 W as shown.

Without the power shunt, the 135 Ω resistor would run into head room issues at 6.0 V and would only be able to drive 21.5 mA as shown in Figure 45 before causing the 2.5 V output to collapse.

Figure 46 shows the power shunt circuitry adding the current back in at low voltage operation. So the power is moved off chip at high voltage where it is needed most.

To further clarify, Figure 47 shows the maximum allowed resistor value (29 Ω) without the power shunt for 6.0 V operation.

Figure 48 shows the scenario at high voltage. Only 290 mW of power is dissipated off chip compared to Figure 44 with 1.35 W.

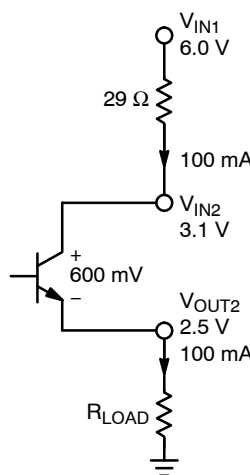

Figure 47.

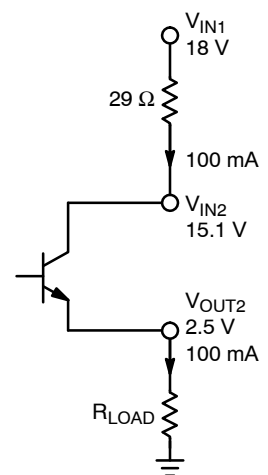

Figure 48.

Power Dissipation

NCV8509 has a power shunt circuit which reduces the power on chip by utilizing an external resistor, R_{EX} . Thus the power on chip, P_{IC} , is equal to the total power, P_T , minus the power dissipated in the resistor $P_{R_{EX}}$. Refer to Figure 49.

$$P_{IC} = P_{TOTAL} - P_{R_{EX}} \quad (1)$$

where

$$P_{TOTAL} = (V_{IN1} - V_{OUT1}) I_{OUT1} \quad (2)$$

$$+ (V_{IN1} - V_{OUT2}) I_{OUT2} + (V_{IN1} \times I_q)$$

and

$$P_{R_{EX}} = (V_{IN1} - V_{IN2}) I_{OUT2} \quad (3)$$

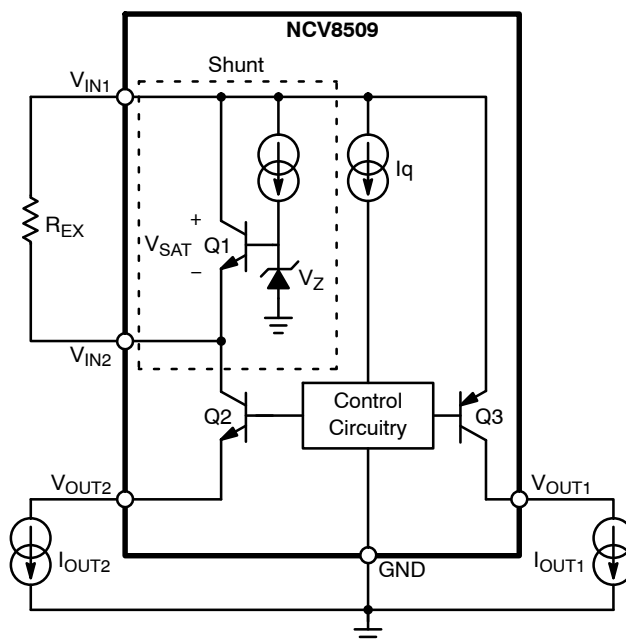

Figure 49.

$$V_{IN2} = \begin{cases} V_{REF} & \text{for } V_{IN1} < (V_{REF} + V_{SAT}) \\ V_{REF} & \text{for } (V_{REF} + V_{SAT}) < V_{IN1} < (V_{REF} + (I_{OUT2} \times R_{EX})) \\ V_{IN1} - (I_{OUT2} \times R_{EX}) & \text{for } (V_{REF} + (I_{OUT2} \times I_{OUT})) < V_{IN1} \end{cases} \quad (4)$$

where $V_{REF} = V_Z - V_{BE}$ when Q1 is normally conducting.

Based on equation 3, the power in R_{EX} is dependent on V_{IN2} . (Increasing R_{EX} may require an increase in C_{IN2} . A careful system validation should be performed for stability). The voltage on V_{IN2} is controlled by the shunt circuit, which has three modes of operation, as seen in Figure 50.

Mode 1. At low battery V_{IN2} is equal to V_{IN1} minus the saturation voltage of the shunt output NPN.

Mode 2. Once V_{IN1} rises above the reference voltage of the shunt circuit, V_{IN2} will regulate at the V_{REF} .

Mode 3. V_{IN2} would continue to regulate at V_{REF} , but since I_{OUT2} is not infinite, when V_{IN1} rises higher than the

reference voltage plus the voltage drop across the external resistor R_{EX} , it will force V_{IN2} to be $V_{IN1} - (I_{OUT2} \times R_{EX})$.

Equation 4 provides a summary for V_{IN2} .

Combining equations 3 and 4 gives three different equations for power across R_{EX} .

$$P_{MODE1} = (V_{SAT} \times I_{OUT2}) \quad (5)$$

$$P_{MODE2} = (V_{IN1} - V_{REF}) \times I_{OUT2} \quad (6)$$

$$P_{MODE3} = I_{OUT2}^2 \times R_{EX} \quad (7)$$

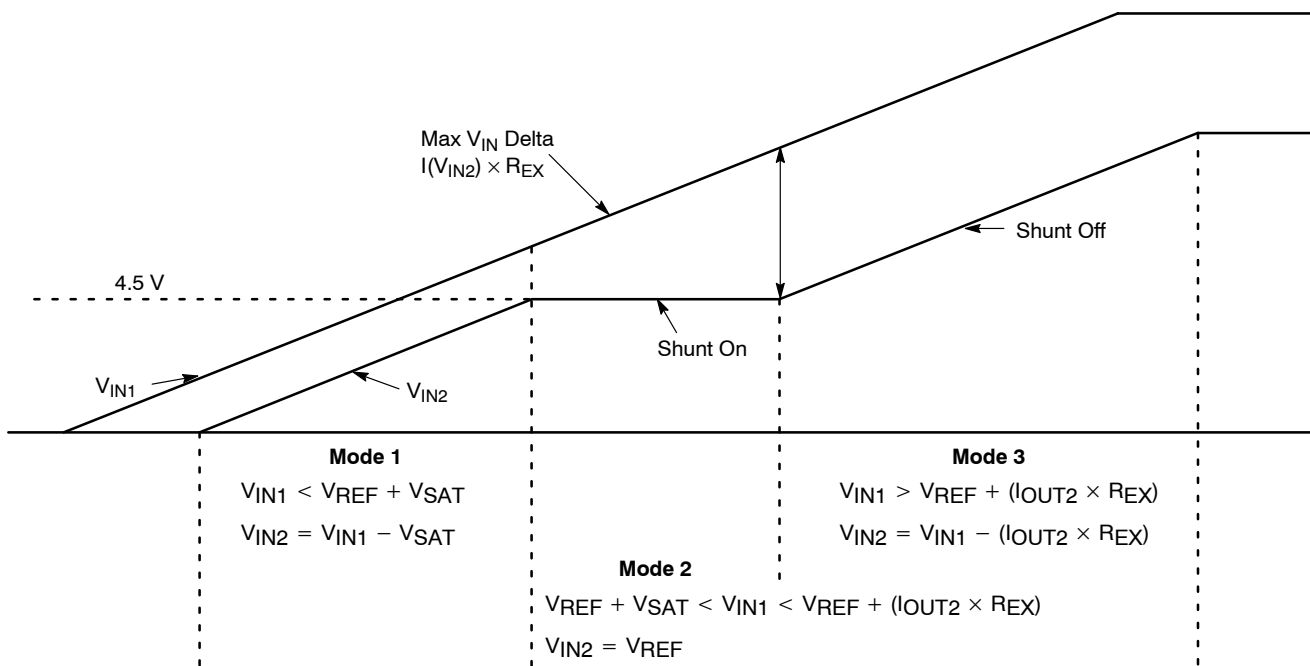

Figure 50. V_{IN} Shunt

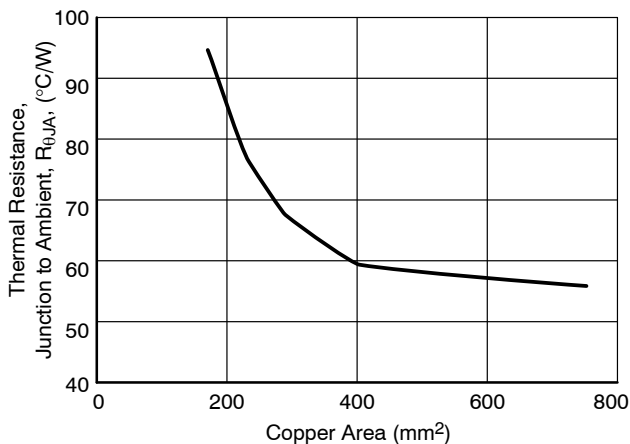

Figure 51. 16 Lead SOW (Exposed Pad), θ_{JA} as a Function of the Pad Copper Area (2 oz. Cu Thickness), Board Material = 0.0625" G-10/R-4

Once the value of $P_{IC(max)}$ is known, the maximum permissible value of $R_{\theta JA}$ can be calculated:

$$R_{\theta JA} = \frac{150^{\circ}\text{C} - T_A}{P_{IC}} \quad (8)$$

The value of $R_{\theta JA}$ can then be compared with those in the package section of the data sheet. Those packages with

$R_{\theta JA}$'s less than the calculated value in equation 2 will keep the die temperature below 150°C .

In some cases, none of the packages will be sufficient to dissipate the heat generated by the IC, and an external heatsink will be required.

Heat Sinks

A heat sink effectively increases the surface area of the package to improve the flow of heat away from the IC and into the surrounding air.

Each material in the heat flow path between the IC and the outside environment will have a thermal resistance. Like series electrical resistances, these resistances are summed to determine the value of $R_{\theta JA}$:

$$R_{\theta JA} = R_{\theta JC} + R_{\theta CS} + R_{\theta SA} \quad (9)$$

where:

$R_{\theta JC}$ = the junction-to-case thermal resistance,
 $R_{\theta CS}$ = the case-to-heatsink thermal resistance, and
 $R_{\theta SA}$ = the heatsink-to-ambient thermal resistance.

$R_{\theta JC}$ appears in the package section of the data sheet. Like $R_{\theta JA}$, it too is a function of package type. $R_{\theta CS}$ and $R_{\theta SA}$ are functions of the package type, heatsink and the interface between them. These values appear in heat sink data sheets of heat sink manufacturers.

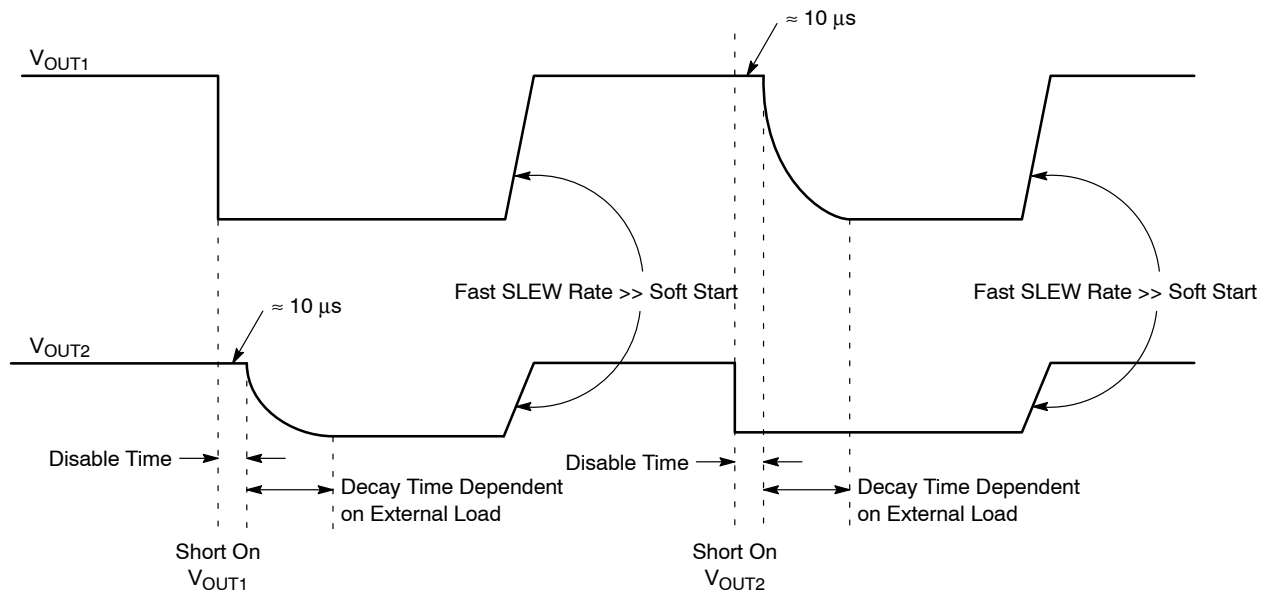

Figure 52. Fault Response. Note the High SLEW Rate Coming Out of Fault Conditions. Soft Start Only Applies to a Power Up Sequence.

Slew Rate Control

Figure 53 shows the circuitry associated with Slew Rate Control. The diagram highlights the control of one output for simplicity. V_{OUT1} and V_{OUT2} are both controlled on the IC.

The slew rate capacitor (C_{SLEW}) is charged with an on-chip current source running at $6.0 \mu A$ (typ.). Charging a capacitor with a current source creates a linear voltage ramp as shown in Figure 54.

The lowest voltage to the positive terminals of the comparator (Error Amp) dominates the output voltage (V_{OUT}). Consequently, when C_{SLEW} is fully discharged on power up, it is the dominant factor on the positive terminal and disables the output. The output (V_{OUT}) follows the linear ramp on the SLEW pin (after being gained up with R1 and R2) until V_{BG} becomes the dominant voltage. This occurs when $SLEW = V_{BG} + V_{D1}$ or approximately 1.8 V.

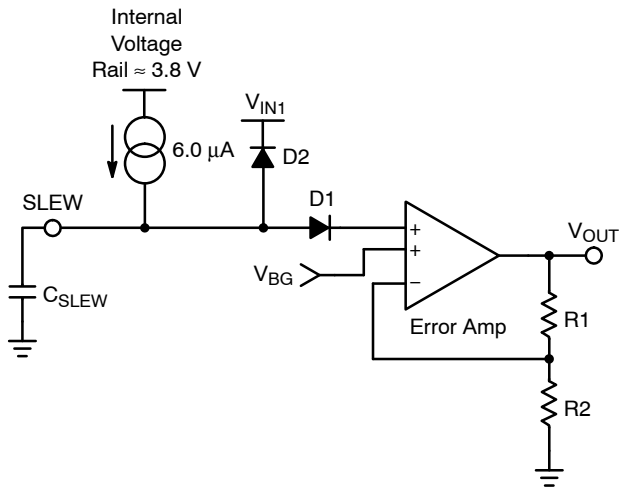

Figure 53. Slew Control Circuitry

Slew time can be calculated using the standard capacitor equation.

$$I = C \frac{dv}{dt}, t = \frac{C(\Delta V)}{I}$$

Using a 33 nF capacitor, the slew time is:

$$t = \frac{(33 \text{ nF})(1.8 \text{ V})}{6 \mu A} = 9.9 \text{ ms}$$

The corresponding slew rate for this is $1.8 \text{ V}/9.9 \text{ ms} = 182 \text{ V/s}$ ON THE SLEW PIN.

To calculate the slew rate on outputs, you must multiply by the gain set up by R1 and R2.

$$A_v = \frac{V_{OUT}}{1.28 \text{ V}}$$

For a 5 V output, the gain would be:

$$A_v = \frac{5 \text{ V}}{1.28 \text{ V}} = 3.9 \text{ V/V}$$

assuming $V_{BG} = 1.28 \text{ V}$.

The resultant slew rate on the output is the slew rate on the SLEW pin multiplied by the gain, or:

$$(182 \text{ V/s}) \times (3.9 \text{ V/V}) = 710 \text{ V/s}$$

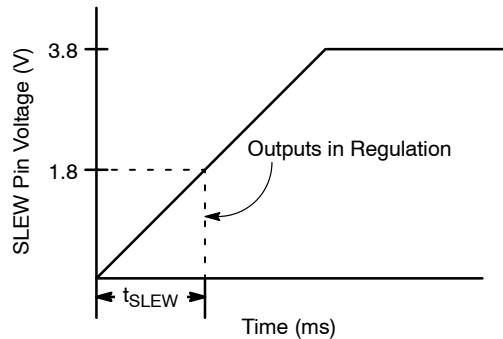

Figure 54.

NCV8509 Series

ORDERING INFORMATION

Device	Output Voltage	Package	Shipping [†]
NCV8509PDW18G	3.3 V/1.8 V	SOIC 16 Lead (Pb-Free)	47 Units/Rail
NCV8509PDW18R2G		SOIC 16 Lead (Pb-Free)	1000 Tape & Reel
NCV8509PDW25G	5 V/2.5 V	SOIC 16 Lead (Pb-Free)	47 Units/Rail
NCV8509PDW25R2G		SOIC 16 Lead (Pb-Free)	1000 Tape & Reel
NCV8509PDW26G	5 V/2.6 V	SOIC 16 Lead (Pb-Free)	47 Units/Rail
NCV8509PDW26R2G		SOIC 16 Lead (Pb-Free)	1000 Tape & Reel

†For information on tape and reel specifications, including part orientation and tape sizes, please refer to our Tape and Reel Packaging Specifications Brochure, BRD8011/D.

MECHANICAL CASE OUTLINE

PACKAGE DIMENSIONS

ON Semiconductor®

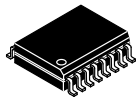

SOIC 16 LEAD WIDE BODY, EXPOSED PAD CASE 751AG ISSUE B

DATE 31 MAY 2016

SCALE 1:1

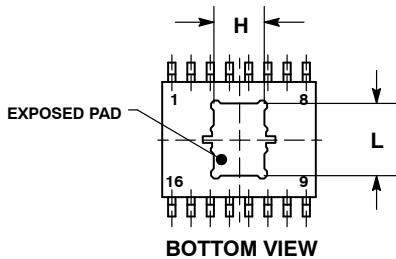
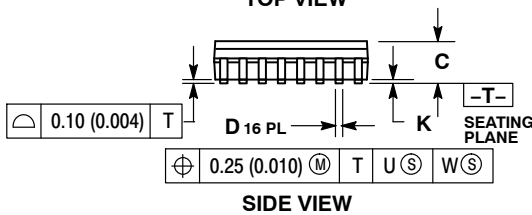
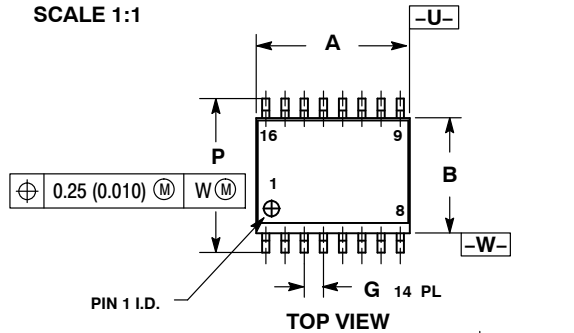

SOLDERING FOOTPRINT*

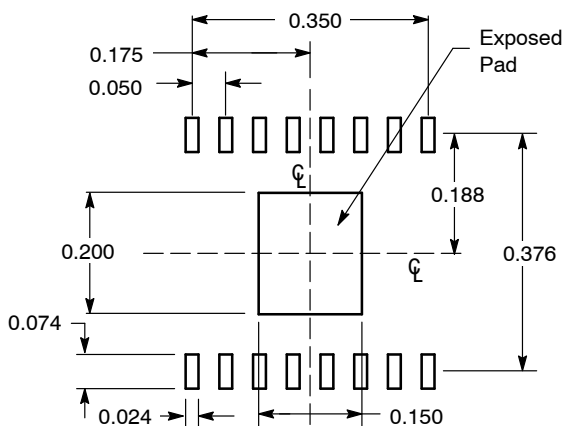

*For additional information on our Pb-Free strategy and soldering details, please download the ON Semiconductor Soldering and Mounting Techniques Reference Manual, SOLDERRM/D.

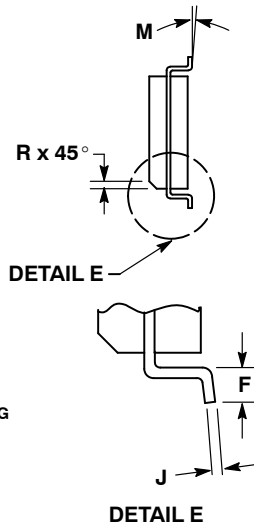

NOTES:

1. DIMENSIONING AND TOLERANCING PER ANSI Y14.5M, 1982.
2. CONTROLLING DIMENSION: MILLIMETER.
3. DIMENSION A AND B DO NOT INCLUDE MOLD PROTRUSION.
4. MAXIMUM MOLD PROTRUSION 0.15 (0.006) PER SIDE.
5. DIMENSION D DOES NOT INCLUDE DAMBAR PROTRUSION. ALLOWABLE PROTRUSION SHALL BE 0.13 (0.005) TOTAL IN EXCESS OF THE D DIMENSION AT MAXIMUM MATERIAL CONDITION.
6. 751R-01 OBSOLETE, NEW STANDARD 751R-02.

DIM	MILLIMETERS		INCHES	
	MIN	MAX	MIN	MAX
A	10.15	10.45	0.400	0.411
B	7.40	7.60	0.292	0.299
C	2.35	2.65	0.093	0.104
D	0.35	0.49	0.014	0.019
F	0.50	0.90	0.020	0.035
G	1.27 BSC		0.050 BSC	
H	3.45	3.66	0.136	0.144
J	0.25	0.32	0.010	0.012
K	0.00	0.10	0.000	0.004
L	4.72	4.93	0.186	0.194
M	0°	7°	0°	7°
P	10.05	10.55	0.395	0.415
R	0.25	0.75	0.010	0.029

GENERIC MARKING DIAGRAM*

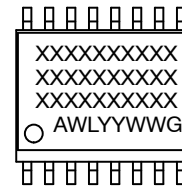

- XXXXXX = Specific Device Code
- A = Assembly Location
- WL = Wafer Lot
- YY = Year
- WW = Work Week
- G = Pb-Free Package

*This information is generic. Please refer to device data sheet for actual part marking. Pb-Free indicator, "G" or microdot "▪", may or may not be present.

DOCUMENT NUMBER:	98AON21237D	Electronic versions are uncontrolled except when accessed directly from the Document Repository. Printed versions are uncontrolled except when stamped "CONTROLLED COPY" in red.
DESCRIPTION:	SOIC-16, WB EXPOSED PAD	PAGE 1 OF 1

ON Semiconductor and ON are trademarks of Semiconductor Components Industries, LLC dba ON Semiconductor or its subsidiaries in the United States and/or other countries. ON Semiconductor reserves the right to make changes without further notice to any products herein. ON Semiconductor makes no warranty, representation or guarantee regarding the suitability of its products for any particular purpose, nor does ON Semiconductor assume any liability arising out of the application or use of any product or circuit, and specifically disclaims any and all liability, including without limitation special, consequential or incidental damages. ON Semiconductor does not convey any license under its patent rights nor the rights of others.

onsemi, **Onsemi**, and other names, marks, and brands are registered and/or common law trademarks of Semiconductor Components Industries, LLC dba "**onsemi**" or its affiliates and/or subsidiaries in the United States and/or other countries. **onsemi** owns the rights to a number of patents, trademarks, copyrights, trade secrets, and other intellectual property. A listing of **onsemi**'s product/patent coverage may be accessed at www.onsemi.com/site/pdf/Patent-Marking.pdf. **onsemi** reserves the right to make changes at any time to any products or information herein, without notice. The information herein is provided "as-is" and **onsemi** makes no warranty, representation or guarantee regarding the accuracy of the information, product features, availability, functionality, or suitability of its products for any particular purpose, nor does **onsemi** assume any liability arising out of the application or use of any product or circuit, and specifically disclaims any and all liability, including without limitation special, consequential or incidental damages. Buyer is responsible for its products and applications using **onsemi** products, including compliance with all laws, regulations and safety requirements or standards, regardless of any support or applications information provided by **onsemi**. "Typical" parameters which may be provided in **onsemi** data sheets and/or specifications can and do vary in different applications and actual performance may vary over time. All operating parameters, including "Typicals" must be validated for each customer application by customer's technical experts. **onsemi** does not convey any license under any of its intellectual property rights nor the rights of others. **onsemi** products are not designed, intended, or authorized for use as a critical component in life support systems or any FDA Class 3 medical devices or medical devices with a same or similar classification in a foreign jurisdiction or any devices intended for implantation in the human body. Should Buyer purchase or use **onsemi** products for any such unintended or unauthorized application, Buyer shall indemnify and hold **onsemi** and its officers, employees, subsidiaries, affiliates, and distributors harmless against all claims, costs, damages, and expenses, and reasonable attorney fees arising out of, directly or indirectly, any claim of personal injury or death associated with such unintended or unauthorized use, even if such claim alleges that **onsemi** was negligent regarding the design or manufacture of the part. **onsemi** is an Equal Opportunity/Affirmative Action Employer. This literature is subject to all applicable copyright laws and is not for resale in any manner.

ADDITIONAL INFORMATION

TECHNICAL PUBLICATIONS:

Technical Library: www.onsemi.com/design/resources/technical-documentation
onsemi Website: www.onsemi.com

ONLINE SUPPORT: www.onsemi.com/support

For additional information, please contact your local Sales Representative at www.onsemi.com/support/sales

Looking for pricing, stock, or lifecycle information?

Click below to explore more details on WIN SOURCE:

 [View NCV8509PDW25](#) on WIN SOURCE

 [ON Semiconductor](#) Information

Optimize Your Supply Chain with WIN SOURCE Solutions

-  Global Sourcing Solution
-  Obsolete Management
-  Cost Control Management
-  Shortage Management
-  Alternative Solution
-  Excess Inventory Management