



**THE DATASHEET OF
BCX5316-13R**



Features

- $BV_{CEO} > -45V, -60V \text{ \& } -80V$
- $I_C = -1A$ Continuous Collector Current
- $I_{CM} = -2A$ Peak Pulse Current
- Low Saturation Voltage $V_{CE(sat)} < -500mV @ -0.5A$
- Gain Groups 10 and 16
- Complementary NPN Types: BCX54, 55, and 56
- **Totally Lead-Free & Fully RoHS Compliant (Notes 1 & 2)**
- **Halogen- and Antimony-Free. "Green" Device (Note 3)**
- **For automotive applications requiring specific change control (i.e. parts qualified to AEC-Q100/101/200, PPAP capable, and manufactured in IATF 16949 certified facilities), please [contact us](mailto:contact@diodes.com) or your local Diodes representative. <https://www.diodes.com/quality/product-definitions/>**

Mechanical Data

- Case: SOT89
- Case Material: Molded Plastic, "Green" Molding Compound; UL Flammability Rating 94V-0
- Moisture Sensitivity: Level 1 per J-STD-020
- Terminals: Matte Tin Finish Leads; Solderable per MIL-STD-202 Method 208 ^(e3)
- Weight: 0.052 grams (Approximate)

Applications

- Medium Power Switching or Amplification Applications
- AF Driver and Output Stages



Top View

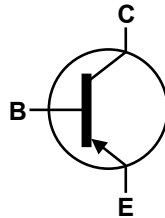

Device Symbol

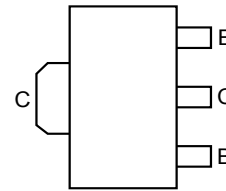

Top View
Pin-Out

Ordering Information (Note 4)

Product	Compliance	Marking	Reel Size (inches)	Tape Width (mm)	Quantity per Reel
BCX51TA	Standard	AA	7	12	1,000
BCX51-13R	Standard	AA	13	12	4,000
BCX5110TA	Standard	AC	7	12	1,000
BCX5116TA	Standard	AD	7	12	1,000
BCX5116TC	Standard	AD	13	12	4,000
BCX52TA	Standard	AE	7	12	1,000
BCX5210TA	Standard	AG	7	12	1,000
BCX5216TA	Standard	AM	7	12	1,000
BCX53TA	Standard	AH	7	12	1,000
BCX5310TA	Standard	AK	7	12	1,000
BCX5316TA	Standard	AL	7	12	1,000
BCX5316TC	Standard	AL	13	12	4,000
BCX5316-13R	Standard	AL	13	12	4,000
BCX5110TC	Standard	AC	13	12	4,000
BCX51TC	Standard	AA	13	12	4,000
BCX5210TC	Standard	AG	13	12	4,000
BCX5216TC	Standard	AM	13	12	4,000
BCX52TC	Standard	AE	13	12	4,000
BCX5310TC	Standard	AK	13	12	4,000
BCX53TC	Standard	AH	13	12	4,000

- Notes:
1. No purposely added lead. Fully EU Directive 2002/95/EC (RoHS), 2011/65/EU (RoHS 2) & 2015/863/EU (RoHS 3) compliant.
 2. See <https://www.diodes.com/quality/lead-free/> for more information about Diodes Incorporated's definitions of Halogen- and Antimony-free, "Green" and Lead-free.
 3. Halogen- and Antimony-free "Green" products are defined as those which contain <900ppm bromine, <900ppm chlorine (<1500ppm total Br + Cl) and <1000ppm antimony compounds.
 4. For packaging details, go to our website at <https://www.diodes.com/design/support/packaging/diodes-packaging/>.

Marking Information

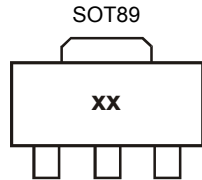

xx = Product Type Marking Code, as follows:

BCX51 = AA	BCX52 = AE	BCX53 = AH
BCX5110 = AC	BCX5210 = AG	BCX5310 = AK
BCX5116 = AD	BCX5216 = AM	BCX5316 = AL

Absolute Maximum Ratings (@ T_A = +25°C, unless otherwise specified.)

Characteristic	Symbol	BCX51	BCX52	BCX53	Unit
Collector-Base Voltage	V _{CBO}	-45	-60	-100	V
Collector-Emitter Voltage	V _{CEO}	-45	-60	-80	V
Emitter-Base Voltage	V _{EBO}		-5		V
Continuous Collector Current	I _C		-1		A
Peak Pulse Collector Current (Single pulse)	I _{CM}		-2		
Continuous Base Current	I _B		-100		mA
Peak Pulse Base Current (Single pulse)	I _{BM}		-200		

Thermal Characteristics (@ T_A = +25°C, unless otherwise specified.)

Characteristic	Symbol	Value	Unit
Power Dissipation	(Note 5)	1	W
	(Note 6)	1.5	
	(Note 7)	2.0	
Thermal Resistance, Junction to Ambient Air	(Note 5)	125	°C/W
	(Note 6)	83	
	(Note 7)	60	
Thermal Resistance, Junction to Lead	(Note 8) R _{θJL}	13	°C/W
Thermal Resistance, Junction to Case	(Note 9) R _{θJC}	27	°C/W
Operating and Storage Temperature Range	T _J , T _{STG}	-55 to +150	°C

ESD Ratings (Note 10)

Characteristic	Symbol	Value	Unit	JEDEC Class
Electrostatic Discharge - Human Body Model	ESD HBM	4,000	V	3A
Electrostatic Discharge - Machine Model	ESD MM	400	V	C

- Notes:
- For a device mounted with the exposed collector pad on 15mm x 15mm 1oz copper that is on a single-sided 1.6mm FR4 PCB; device is measured under still air conditions whilst operating in a steady-state.
 - Same as Note 5, except the device is mounted on 25mm x 25mm 1oz copper.
 - Same as Note 5, except the device is mounted on 50mm x 50mm 1oz copper.
 - Thermal resistance from junction to solder-point (on the exposed collector pad).
 - Thermal resistance from junction to the top of the case.
 - Refer to JEDEC specification JESD22-A114 and JESD22-A115.

Thermal Characteristics and Derating Information

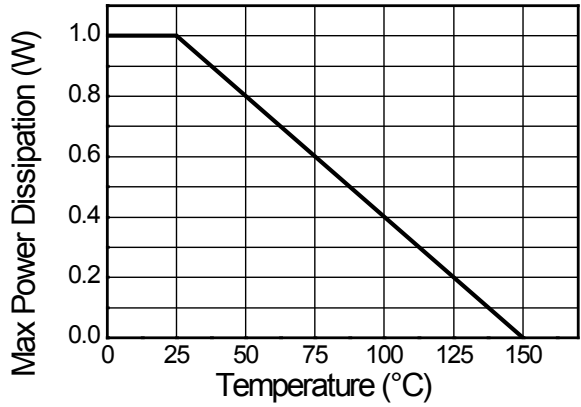

Derating Curve

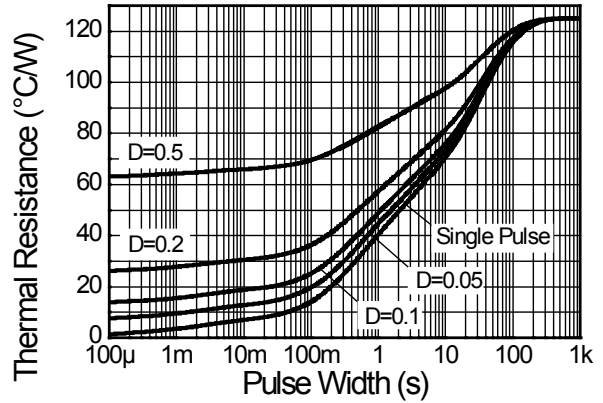

Transient Thermal Impedance

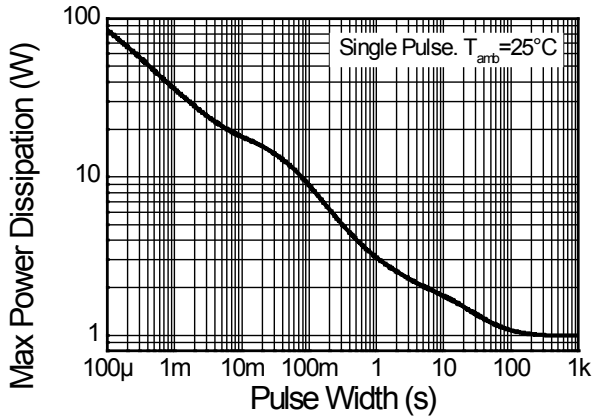

Pulse Power Dissipation

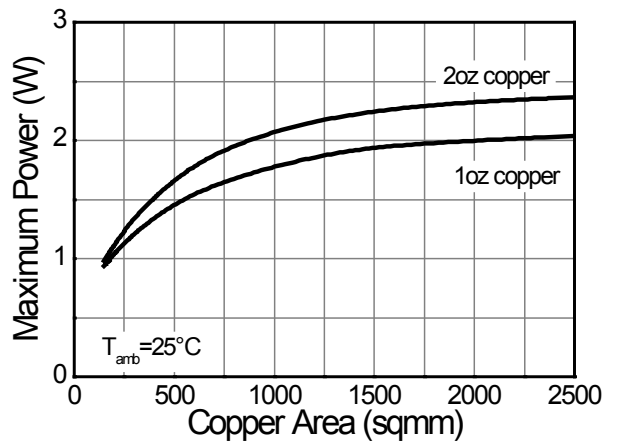
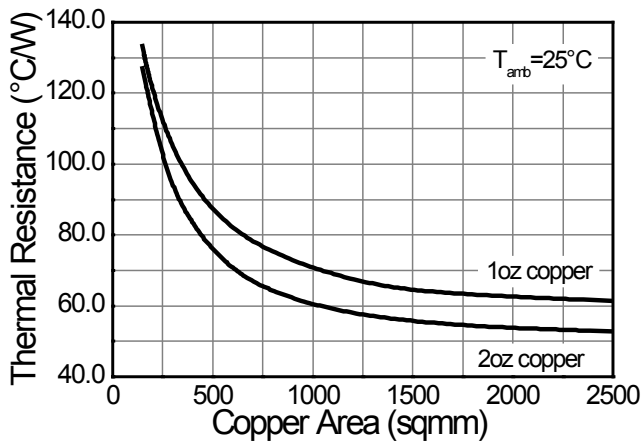

Electrical Characteristics (@ $T_A = +25^\circ\text{C}$, unless otherwise specified.)

Characteristic	Symbol	Min	Typ	Max	Unit	Test Condition
Collector-Base Breakdown Voltage	BV_{CBO}	-45	—	—	V	$I_C = -100\mu\text{A}$
		-60				
		-100				
Collector-Emitter Breakdown Voltage (Note 11)	BV_{CEO}	-45	—	—	V	$I_C = -10\text{mA}$
		-60				
		-80				
Emitter-Base Breakdown Voltage	BV_{EBO}	-5	—	—	V	$I_E = -10\mu\text{A}$
Collector Cut-Off Current	I_{CBO}	—	—	-0.1 -20	μA	$V_{CB} = -30\text{V}$ $V_{CB} = -30\text{V}, T_J = +150^\circ\text{C}$
Emitter Cut-Off Current	I_{EBO}	—	—	-20	nA	$V_{EB} = -5\text{V}$
DC Current Gain (Note 11)	h_{FE}	25	—	—	—	$I_C = -5\text{mA}, V_{CE} = -2\text{V}$ $I_C = -150\text{mA}, V_{CE} = -2\text{V}$ $I_C = -500\text{mA}, V_{CE} = -2\text{V}$
		40				
		25				
		63				
	10 gain grp	63	—	160		$I_C = -150\text{mA}, V_{CE} = -2\text{V}$
	16 gain grp	100	—	250		$I_C = -150\text{mA}, V_{CE} = -2\text{V}$
Collector-Emitter Saturation Voltage (Note 11)	$V_{CE(sat)}$	—	—	-0.5	V	$I_C = -500\text{mA}, I_B = -50\text{mA}$
Base-Emitter Turn-On Voltage (Note 11)	$V_{BE(on)}$	—	—	-1.0	V	$I_C = -500\text{mA}, V_{CE} = -2\text{V}$
Transition frequency	f_T	150	—	—	MHz	$I_C = -50\text{mA}, V_{CE} = -10\text{V}$ $f = 100\text{MHz}$
Output Capacitance	C_{obo}	—	—	25	pF	$V_{CB} = -10\text{V}, f = 1\text{MHz}$

 Note: 11. Measured under pulsed conditions. Pulse width $\leq 300\mu\text{s}$. Duty cycle $\leq 2\%$.

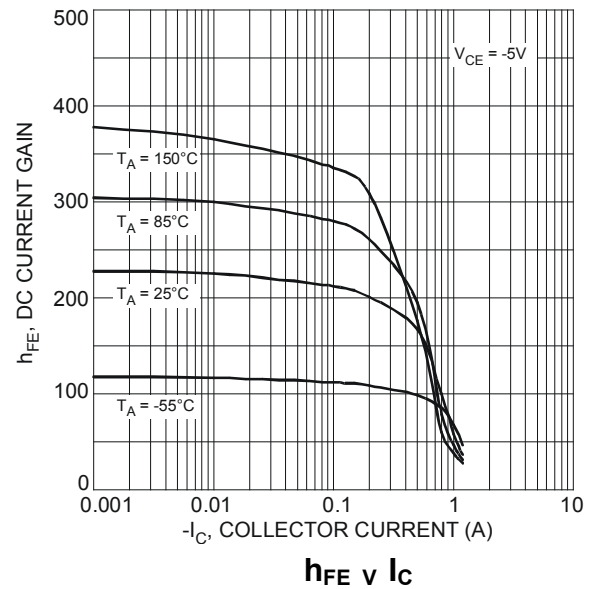
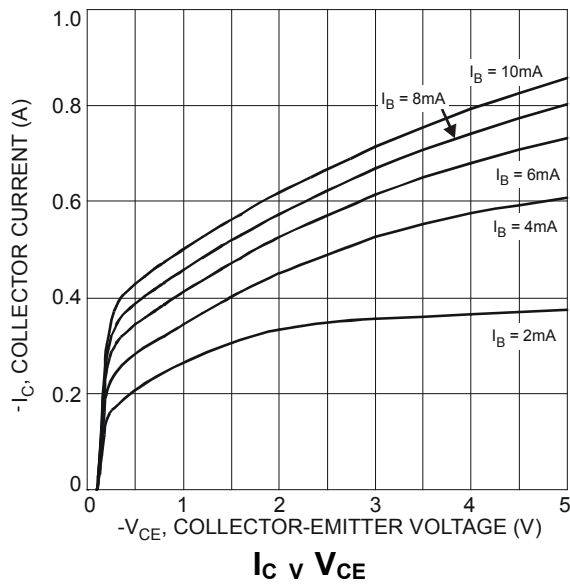
Typical Electrical Characteristics (@ $T_A = +25^\circ\text{C}$, unless otherwise specified.)

Typical Electrical Characteristics (continued.)

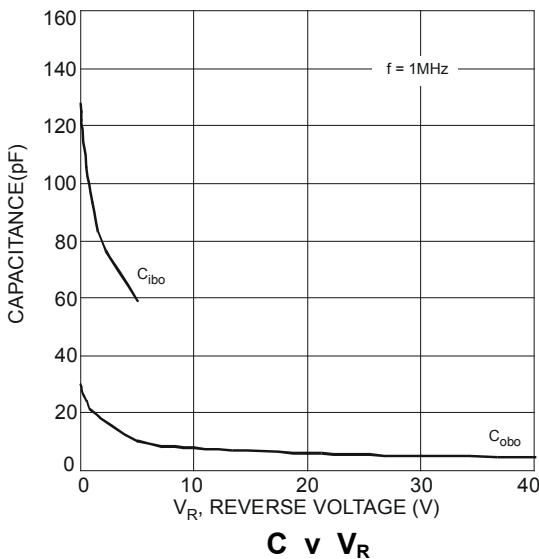
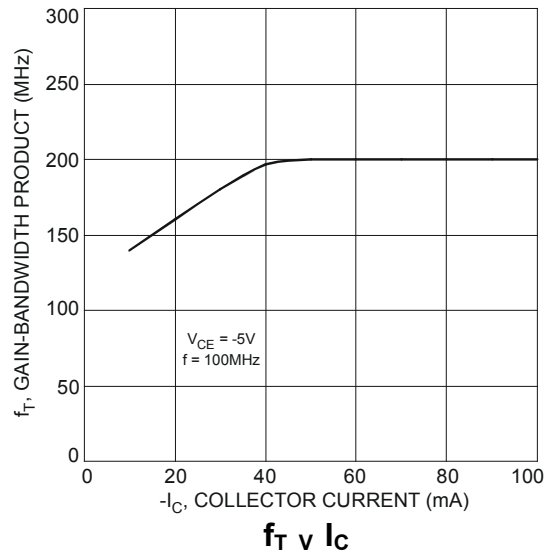
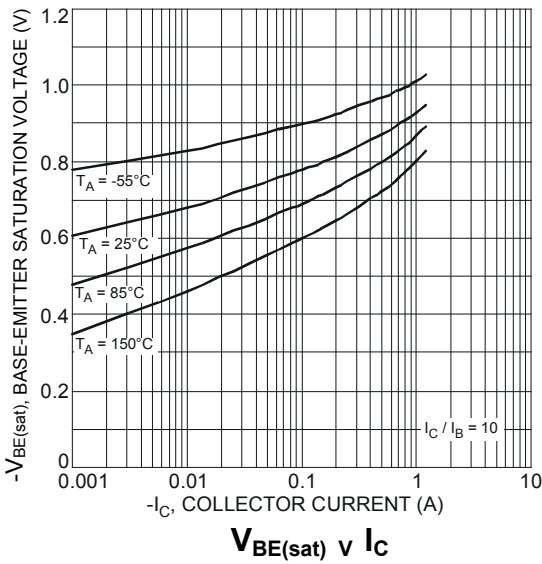
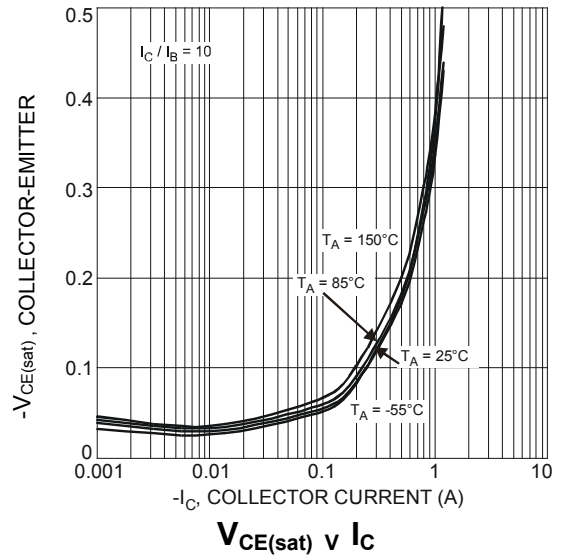
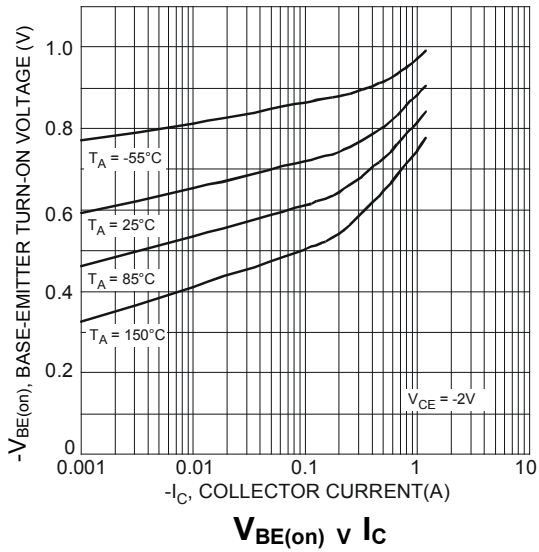

Package Outline Dimensions

Please see <http://www.diodes.com/package-outlines.html> for the latest version.

SOT89

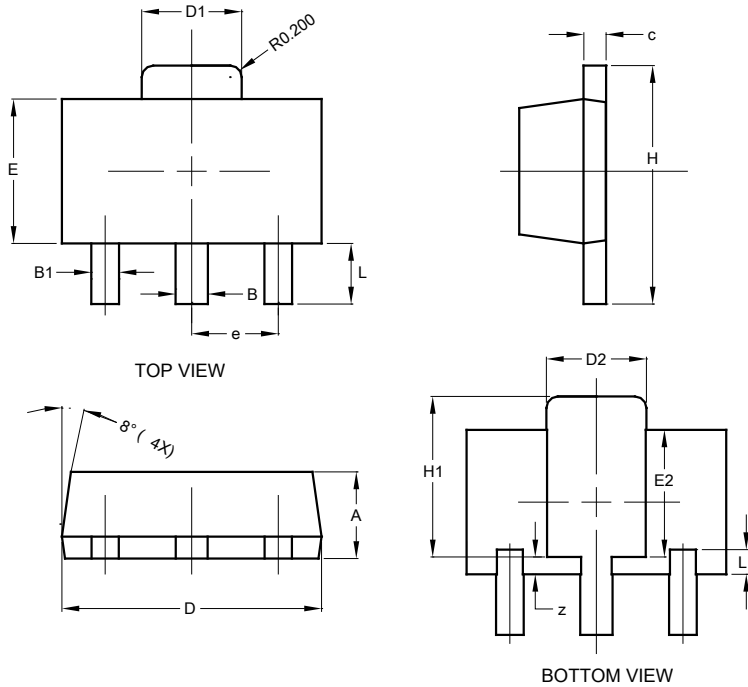

SOT89			
Dim	Min	Max	Typ
A	1.40	1.60	1.50
B	0.50	0.62	0.56
B1	0.42	0.54	0.48
c	0.35	0.43	0.38
D	4.40	4.60	4.50
D1	1.62	1.83	1.733
D2	1.61	1.81	1.71
E	2.40	2.60	2.50
E2	2.05	2.35	2.20
e	-	-	1.50
H	3.95	4.25	4.10
H1	2.63	2.93	2.78
L	0.90	1.20	1.05
L1	0.327	0.527	0.427
z	0.20	0.40	0.30
All Dimensions in mm			

Suggested Pad Layout

Please see <http://www.diodes.com/package-outlines.html> for the latest version.

SOT89

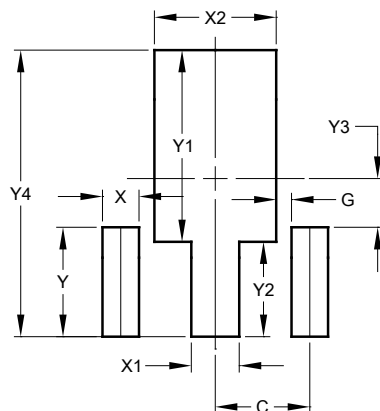

Dimensions	Value (in mm)
C	1.500
G	0.244
X	0.580
X1	0.760
X2	1.933
Y	1.730
Y1	3.030
Y2	1.500
Y3	0.770
Y4	4.530

IMPORTANT NOTICE

1. DIODES INCORPORATED AND ITS SUBSIDIARIES (“DIODES”) MAKE NO WARRANTY OF ANY KIND, EXPRESS OR IMPLIED, WITH REGARDS TO ANY INFORMATION CONTAINED IN THIS DOCUMENT, INCLUDING, BUT NOT LIMITED TO, THE IMPLIED WARRANTIES OF MERCHANTABILITY, FITNESS FOR A PARTICULAR PURPOSE OR NON-INFRINGEMENT OF THIRD PARTY INTELLECTUAL PROPERTY RIGHTS (AND THEIR EQUIVALENTS UNDER THE LAWS OF ANY JURISDICTION).
2. The Information contained herein is for informational purpose only and is provided only to illustrate the operation of Diodes products described herein and application examples. Diodes does not assume any liability arising out of the application or use of this document or any product described herein. This document is intended for skilled and technically trained engineering customers and users who design with Diodes products. Diodes products may be used to facilitate safety-related applications; however, in all instances customers and users are responsible for (a) selecting the appropriate Diodes products for their applications, (b) evaluating the suitability of the Diodes products for their intended applications, (c) ensuring their applications, which incorporate Diodes products, comply the applicable legal and regulatory requirements as well as safety and functional-safety related standards, and (d) ensuring they design with appropriate safeguards (including testing, validation, quality control techniques, redundancy, malfunction prevention, and appropriate treatment for aging degradation) to minimize the risks associated with their applications.
3. Diodes assumes no liability for any application-related information, support, assistance or feedback that may be provided by Diodes from time to time. Any customer or user of this document or products described herein will assume all risks and liabilities associated with such use, and will hold Diodes and all companies whose products are represented herein or on Diodes’ websites, harmless against all damages and liabilities.
4. Products described herein may be covered by one or more United States, international or foreign patents and pending patent applications. Product names and markings noted herein may also be covered by one or more United States, international or foreign trademarks and trademark applications. Diodes does not convey any license under any of its intellectual property rights or the rights of any third parties (including third parties whose products and services may be described in this document or on Diodes’ website) under this document.
5. Diodes products are provided subject to Diodes’ Standard Terms and Conditions of Sale (<https://www.diodes.com/about/company/terms-and-conditions/terms-and-conditions-of-sales/>) or other applicable terms. This document does not alter or expand the applicable warranties provided by Diodes. Diodes does not warrant or accept any liability whatsoever in respect of any products purchased through unauthorized sales channel.
6. Diodes products and technology may not be used for or incorporated into any products or systems whose manufacture, use or sale is prohibited under any applicable laws and regulations. Should customers or users use Diodes products in contravention of any applicable laws or regulations, or for any unintended or unauthorized application, customers and users will (a) be solely responsible for any damages, losses or penalties arising in connection therewith or as a result thereof, and (b) indemnify and hold Diodes and its representatives and agents harmless against any and all claims, damages, expenses, and attorney fees arising out of, directly or indirectly, any claim relating to any noncompliance with the applicable laws and regulations, as well as any unintended or unauthorized application.
7. While efforts have been made to ensure the information contained in this document is accurate, complete and current, it may contain technical inaccuracies, omissions and typographical errors. Diodes does not warrant that information contained in this document is error-free and Diodes is under no obligation to update or otherwise correct this information. Notwithstanding the foregoing, Diodes reserves the right to make modifications, enhancements, improvements, corrections or other changes without further notice to this document and any product described herein. This document is written in English but may be translated into multiple languages for reference. Only the English version of this document is the final and determinative format released by Diodes.
8. Any unauthorized copying, modification, distribution, transmission, display or other use of this document (or any portion hereof) is prohibited. Diodes assumes no responsibility for any losses incurred by the customers or users or any third parties arising from any such unauthorized use.

Copyright © 2021 Diodes Incorporated

www.diodes.com

Looking for pricing, stock, or lifecycle information?

Click below to explore more details on WIN SOURCE:

- [⊖ View BCX5316-13R on WIN SOURCE](#)
- [⊖ Diodes Incorporated Information](#)

Optimize Your Supply Chain with WIN SOURCE Solutions

- ✓ Global Sourcing Solution
- ✓ Obsolete Management
- ✓ Cost Control Management
- ✓ Shortage Management
- ✓ Alternative Solution
- ✓ Excess Inventory Management